



**Calhoun: The NPS Institutional Archive**  
**DSpace Repository**

---

Theses and Dissertations

1. Thesis and Dissertation Collection, all items

---

2006-12

# OPNAV N432D responsibilities and impact on budget formulation for the Navy Flying Hour Program

Jarvis, David K.

Monterey, California. Naval Postgraduate School

---

<https://hdl.handle.net/10945/10077>

---

*Downloaded from NPS Archive: Calhoun*



Calhoun is the Naval Postgraduate School's public access digital repository for research materials and institutional publications created by the NPS community. Calhoun is named for Professor of Mathematics Guy K. Calhoun, NPS's first appointed -- and published -- scholarly author.

**Dudley Knox Library / Naval Postgraduate School**  
**411 Dyer Road / 1 University Circle**  
**Monterey, California USA 93943**

<http://www.nps.edu/library>



**NAVAL  
POSTGRADUATE  
SCHOOL**

**MONTEREY, CALIFORNIA**

---

**MBA PROFESSIONAL REPORT**

---

**OPNAV N432D Responsibilities and Impact  
on Budget Formulation for  
the Navy Flying Hour Program**

---

**By: David K. Jarvis  
December 2006**

**Principal Advisor: Lawrence R. Jones  
Associate Advisor: Jerry L. McCaffery**

*Approved for public release; distribution is unlimited.*

THIS PAGE INTENTIONALLY LEFT BLANK

<b>REPORT DOCUMENTATION PAGE</b>			<i>Form Approved OMB No. 0704-0188</i>	
Public reporting burden for this collection of information is estimated to average 1 hour per response, including the time for reviewing instruction, searching existing data sources, gathering and maintaining the data needed, and completing and reviewing the collection of information. Send comments regarding this burden estimate or any other aspect of this collection of information, including suggestions for reducing this burden, to Washington headquarters Services, Directorate for Information Operations and Reports, 1215 Jefferson Davis Highway, Suite 1204, Arlington, VA 22202-4302, and to the Office of Management and Budget, Paperwork Reduction Project (0704-0188) Washington DC 20503.				
<b>1. AGENCY USE ONLY (Leave blank)</b>		<b>2. REPORT DATE</b> December 2006	<b>3. REPORT TYPE AND DATES COVERED</b> MBA Professional Report	
<b>4. TITLE AND SUBTITLE:</b> OPNAV N432D Responsibilities and Impact on Budget Formulation for the Navy Flying Hour Program			<b>5. FUNDING NUMBERS</b>	
<b>6. AUTHOR</b> David K. Jarvis				
<b>7. PERFORMING ORGANIZATION NAME(S) AND ADDRESS(ES)</b> Naval Postgraduate School Monterey, CA 93943-5000			<b>8. PERFORMING ORGANIZATION REPORT NUMBER</b>	
<b>9. SPONSORING / MONITORING AGENCY NAME(S) AND ADDRESS(ES)</b> N/A			<b>10. SPONSORING / MONITORING AGENCY REPORT NUMBER</b>	
<b>11. SUPPLEMENTARY NOTES</b> The views expressed in this report are those of the author and do not reflect the official policy or position of the Department of Defense or the U.S. Government.				
<b>12a. DISTRIBUTION / AVAILABILITY STATEMENT</b> Approved for public release; distribution is unlimited			<b>12b. DISTRIBUTION CODE</b> A	
<b>13. ABSTRACT (maximum 200 words)</b>  <p>OPNAV N432D serves as the Navy's resident expert on the Flying Hour Program (FHP) and the chief agent in the management of FHP funding. The Navy utilizes the Department of Defense Planning, Programming, Budgeting and Execution System (PPBES) to provide the resources for the FHP. Due to the complexity of the PPBES and the FHP management procedures and processes, new officers assigned to N432D spend a large portion of their first year on the job merely observing and learning their jobs, which results in reduced productivity.</p> <p>The purpose of this professional report is to identify the responsibilities, key knowledge areas and tasks of N432D Aviation FHP Officers and to analyze their role and impact in the budget formulation process for the Navy FHP. This document provides a one-source reference for new members of N432D to improve their productivity in their first year on the job.</p>				
<b>14. SUBJECT TERMS</b> Flying Hour Program, PPBES, Naval Aviation, Flying Hour Projection System			<b>15. NUMBER OF PAGES</b> 81	
			<b>16. PRICE CODE</b>	
<b>17. SECURITY CLASSIFICATION OF REPORT</b> Unclassified	<b>18. SECURITY CLASSIFICATION OF THIS PAGE</b> Unclassified	<b>19. SECURITY CLASSIFICATION OF ABSTRACT</b> Unclassified	<b>20. LIMITATION OF ABSTRACT</b> UL	

THIS PAGE INTENTIONALLY LEFT BLANK

**Approved for public release; distribution is unlimited**

**OPNAV N432D RESPONSIBILITIES AND IMPACT  
ON BUDGET FORMULATION FOR  
THE NAVY FLYING HOUR PROGRAM**

David K. Jarvis, Major, United States Marine Corps

Submitted in partial fulfillment of the requirements for the degree of

**MASTER OF BUSINESS ADMINISTRATION**

from the

**NAVAL POSTGRADUATE SCHOOL  
December 2006**

Author:

---

David K. Jarvis

Approved by:

---

Lawrence R. Jones  
Principal Advisor

---

Jerry McCaffery  
Associate Advisor

---

Robert N. Beck, Dean  
Graduate School of Business and Public Policy

THIS PAGE INTENTIONALLY LEFT BLANK

# **OPNAV N432D RESPONSIBILITIES AND IMPACT ON BUDGET FORMULATION FOR THE NAVY FLYING HOUR PROGRAM**

## **ABSTRACT**

OPNAV N432D serves as the Navy's resident expert on the Flying Hour Program (FHP) and the chief agent in the management of FHP funding. The Navy utilizes the Department of Defense Planning, Programming, Budgeting and Execution System (PPBES) to provide the resources for the FHP. Due to the complexity of the PPBES and the FHP management procedures and processes, new officers assigned to N432D spend a large portion of their first year on the job merely observing and learning their jobs, which results in reduced productivity.

The purpose of this professional report is to identify the responsibilities, key knowledge areas and tasks of N432D Aviation FHP Officers and to analyze their role and impact in the budget formulation process for the Navy FHP. This document provides a one-source reference for new members of N432D to improve their productivity in their first year on the job.



THIS PAGE INTENTIONALLY LEFT BLANK

# TABLE OF CONTENTS

<b>I.</b>	<b>INTRODUCTION.....</b>	<b>1</b>
<b>A.</b>	<b>BACKGROUND .....</b>	<b>1</b>
<b>B.</b>	<b>PURPOSE.....</b>	<b>2</b>
<b>C.</b>	<b>RESEARCH QUESTIONS.....</b>	<b>3</b>
<b>1.</b>	<b>Primary Research Question.....</b>	<b>3</b>
<b>2.</b>	<b>Secondary Research Questions.....</b>	<b>3</b>
<b>D.</b>	<b>METHODOLOGY .....</b>	<b>4</b>
<b>E.</b>	<b>CHAPTER OUTLINE.....</b>	<b>4</b>
<b>II.</b>	<b>THE NAVY FLYING HOUR PROGRAM AND DOD FUNDING PROCESS ....</b>	<b>7</b>
<b>A.</b>	<b>INTRODUCTION.....</b>	<b>7</b>
<b>B.</b>	<b>PPBES OVERVIEW .....</b>	<b>7</b>
<b>1.</b>	<b>Planning .....</b>	<b>10</b>
<b>2.</b>	<b>Programming.....</b>	<b>11</b>
<b>3.</b>	<b>Budgeting.....</b>	<b>11</b>
<b>4.</b>	<b>Execution .....</b>	<b>12</b>
<b>C.</b>	<b>THE NAVY FLYING HOUR PROGRAM OVERVIEW .....</b>	<b>13</b>
<b>1.</b>	<b>FHP Funding .....</b>	<b>14</b>
<b>2.</b>	<b>Management of the Flying Hour Program.....</b>	<b>18</b>
<b>D.</b>	<b>CHAPTER SUMMARY.....</b>	<b>20</b>
<b>III.</b>	<b>OPNAV N432D AVIATION FLYING HOUR PROGRAM OFFICER ROLES AND RESPONSIBILITIES.....</b>	<b>21</b>
<b>A.</b>	<b>INTRODUCTION.....</b>	<b>21</b>
<b>B.</b>	<b>KEY KNOWLEDGE AREAS .....</b>	<b>21</b>
<b>1.</b>	<b>Aviation Background.....</b>	<b>21</b>
<b>2.</b>	<b>Financial Management MBA Background.....</b>	<b>22</b>
<b>3.</b>	<b>Section Summary .....</b>	<b>23</b>
<b>C.</b>	<b>OPNAV N432D PRIMARY TASKS .....</b>	<b>23</b>
<b>1.</b>	<b>Management of the Flying Hour Projection System (FHPS).....</b>	<b>25</b>
<b>a.</b>	<b><i>Inputs to the FHPS .....</i></b>	<b>25</b>
<b>b.</b>	<b><i>Operational Plan 20 (OP-20).....</i></b>	<b>31</b>
<b>2.</b>	<b>Management of Stakeholders.....</b>	<b>33</b>
<b>a.</b>	<b><i>Navy Aviation .....</i></b>	<b>33</b>
<b>b.</b>	<b><i>Marine Aviation .....</i></b>	<b>35</b>
<b>c.</b>	<b><i>OPNAV N80 .....</i></b>	<b>36</b>
<b>d.</b>	<b><i>OPNAV N81 .....</i></b>	<b>37</b>
<b>e.</b>	<b><i>FMB/OPNAV N82 .....</i></b>	<b>38</b>
<b>D.</b>	<b>CHAPTER SUMMARY.....</b>	<b>39</b>
<b>IV.</b>	<b>OPNAV N432D ROLE IN FHP BUDGET FORMULATION.....</b>	<b>41</b>
<b>A.</b>	<b>INTRODUCTION.....</b>	<b>41</b>
<b>B.</b>	<b>FLYING HOUR PROGRAM CONFERENCE.....</b>	<b>42</b>

C.	DATA CALL .....	43
D.	BASELINE EXECUTION YEAR ANALYSIS.....	44
E.	CAPABILITIES PLAN .....	46
F.	INTEGRATED READINESS CAPABILITIES ASSESSMENT.....	47
G.	SPONSOR PROGRAM PROPOSAL.....	49
H.	CHAPTER SUMMARY.....	50
V.	CONCLUSION .....	51
A.	INTRODUCTION.....	51
B.	PRIMARY RESEARCH QUESTION.....	51
C.	SECONDARY RESEARCH QUESTIONS.....	52
D.	CONCLUSIONS .....	53
E.	SUGGESTIONS FOR FURTHER RESEARCH.....	54
	LIST OF REFERENCES .....	57
	INITIAL DISTRIBUTION LIST .....	61

## LIST OF FIGURES

Figure 1.	Trends in Appropriation Accounts.....	2
Figure 2.	PPBE Biennial Cycle “On-Year”.....	9
Figure 3.	PPBE Biennial Cycle “Off-Year”.....	10
Figure 4.	Scope of the Flying Hour Program.....	16
Figure 5.	FHP Funding Composition.....	17
Figure 6.	Readiness and Logistics Organization.....	19
Figure 7.	OPNAV FHP Action Officers.....	20
Figure 8.	FHP Feedback Mechanisms.....	24
Figure 9.	Budget Process Overlap.....	25
Figure 10.	Flying Hour Projection System.....	26
Figure 11.	Pricing Methodology for Cost Per Hour.....	29
Figure 12.	Flying Hour Costs.....	31
Figure 13.	OP-20 Example.....	32
Figure 14.	Flying Hour Resource Model.....	34
Figure 15.	N432D Budget Formulation Timeline.....	42

THIS PAGE INTENTIONALLY LEFT BLANK

## LIST OF TABLES

Table 1.	Phases of the PPBES.....	13
Table 2.	Special Interest Codes.....	30
Table 3.	Data Call Flying Hour Model Requirements.....	44
Table 4.	Data Call Pricing Model Requirements.....	45
Table 5.	NAE Board of Directors.....	48

THIS PAGE INTENTIONALLY LEFT BLANK

## TERMS AND ACRONYMS

AFO	Aircraft Flight Operations
AG	Activity Group
AMF	Aircrew Manning Factor
AOM	Aircraft Operations Maintenance
APDF	Aircraft Program Data File
ASN, FM&C	Assistant Secretary of the Navy, Financial Management and Comptroller
AVDLR	Aviation Depot Level Repairable
BA	Budget Authority
BCP	Budget Change Proposal
BES	Budget Estimate Submission
Blue	Navy Appropriations
BSO	Budget Submitting Office
BY	Budget Year
CAVTS	Cost Adjustment Visibility Tracking System
CCRM	Core Competency Resource Model
CFFC	Commander Fleet Forces Command
CJCS	Chairman of the Joint Chiefs of Staff
CMC	Commandant of the Marine Corps
CNA	Center for Naval Analyses
CNATRA	Chief of Naval Air Training
CNAF	Commander Naval Air Forces
CNAFR	Commander Naval Air Forces Reserve
CNAL	Commander Naval Air Forces Atlantic
CNAP	Commander Naval Air Forces Pacific
CNET	Chief of Naval Education and Training
CNO	Chief of Naval Operations
CNRFC	Commander Naval Reserve Forces Command
COCOM	Combatant Commander
COMLANTFLT	Commander U.S. Atlantic Fleet
COMNAVEUR	Commander Naval Forces Europe
COMNAVRESFOR	Commander Naval Reserve Forces
COMPACFLT	Commander U.S. Pacific Fleet
CP	Capabilities Plan
CPH	Cost Per Hour
CSG	Carrier Strike Group
CSR	Crew Seat Ratio
CY	Current Year



DoD	Department of Defense
DoN	Department of the Navy
FYDP	Future Years Defense Program
FAS	Fleet Air Support
FAT	Fleet Air Training
FHCR	Flying Hour Cost Report
FHRM	Flying Hour Resource Model
FHP	Flying Hour Program
FHPS	Flying Hour Projection System
FMB	Fiscal Management and Budget
FY	Fiscal Year
FYDP	Future Years Defense Programs
GWOT	Global War on Terror
HQMC	Headquarters Marine Corps
IRCA	Integrated Readiness Capability Assessment
JCS	Joint Chiefs of Staff
LECH	Logistics Engineering Change Proposal
MFP	Major Force Program
NAVAIR	Naval Air Systems Command
NAVICP	Naval Inventory Control Point
NAVSEALOGCEN	Naval Sea Logistics Center
NAVSUP	Naval Supply Systems Command
NETC	Naval Education and Training Command
NMS	National Military Strategy
NPS	Naval Postgraduate School
NSAWC	Naval Strike and Air Warfare Center
NSS	National Security Strategy
OFC	Operational Target Functional Category
OMB	Office of Management and Budget
OMN	Operations and Maintenance, Navy
OMNR	Operations and Maintenance, Navy Reserve
OPNAV	Office of the Chief of Naval Operations
OPTAR	Operating Target
OSD	Office of the Secretary of Defense
PB	President's Budget
PBD	Program Budget Decision

PCP	Program Change Proposal
PDM	Program Decision Memorandum
POM	Program Objective Memorandum
PPBES	Planning Programming Budgeting Execution System
SAG	Sub-Activity Group
SBTP	Sortie Based Training Program
SECDEF	Secretary of Defense
SECNAV	Secretary of the Navy
SPP	Sponsor Program Proposal
SPG	Strategic Planning Guidance
SYSCOM	System Command
TACAIR	Tactical Aviation
T/M/S	Type/Model/Series of Aircraft
TOA	Total Obligational Authority
TYCOM	Type Commander
WCF	Working Capital Fund

THIS PAGE INTENTIONALLY LEFT BLANK

## **ACKNOWLEDGMENTS**

I want to thank my wife, Emily, for her tremendous support and understanding during the writing of this MBA Professional Report. Her patience and encouragement enabled me to devote the required time to complete this report.

This MBA Professional Report would not have been possible without the tremendous amount of help I received from N432D, specifically LtCol Bob Darling and CDR Eugene Young. Thank you for your patience in explaining the process to the rookie.

Finally, I want to thank Professor Larry Jones and Professor Jerry McCaffery for pointing me in the right direction and their expert advice on the budget cycle and the Flying Hour Program.

THIS PAGE INTENTIONALLY LEFT BLANK

## I. INTRODUCTION

### A. BACKGROUND

Irrespective of the ebb and flow of the Department of Defense (DoD) budget over the last twenty-five years, Navy and Marine Corps squadrons have had to maintain their operational and material readiness to be an effective part of our National Military Strategy (NMS). The mission of these aircraft have been vital to national security, be it in time of peace, expeditionary and short term crisis (1990's) or war (Iraq, Afghanistan).

Naval Aviation's current combat readiness is responsible for much of the success in the Global War on Terror (GWOT). Achieving air superiority over Afghanistan, Navy and Marine Corps aircraft set Operation Enduring Freedom in motion, flying over half the total sorties. For Operation Iraqi Freedom (OIF) in 2003, five carriers plus amphibious ships and shore-based detachments brought an armada of striking power from the sea. Over 700 Navy and Marine Corps aircraft of all types supported OIF. Forty-six percent of the strike aircraft deployed for OIF came from the Navy and Marine Corps, flying over 8,000 sorties and delivering nearly 9,000 precision-guided munitions (CNAF, 2006).

This quote from the Commander Naval Air Forces (CNAF) document, *Naval Aviation Vision 2020*, highlights the important role of Naval Aviation during operations in Iraq and Afghanistan. Missions such as interdiction and close air support have been essential in these two campaigns. In order to have enough highly trained aircrews and operational aircraft to accomplish these missions, the Department of the Navy (DoN) must allocate the proper amount of flying hours and resources to its aviation forces. The system the Navy uses to do this is called the Flying Hour Program (FHP). The Flying Hour Program resides in the appropriation account of Operations and Maintenance (O&M). While other accounts have fluctuated with the times, this account has remained important and has grown, as can be seen from Figure 1 below.

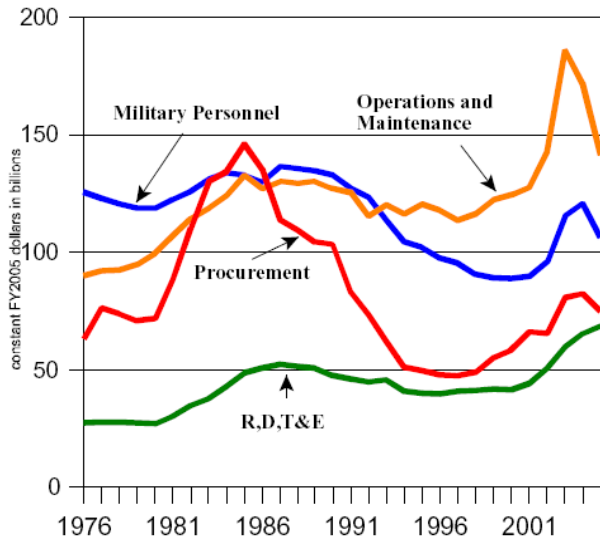

Source: Office of Management and Budget, *Historical Tables: Budget of the United States Government, Fiscal Year 2005*, February 2004, pp. 82-85, [<http://www.whitehouse.gov/omb/budget/fy2005/pdf/hist.pdf>]; FY2005 deflators from DOD Comptroller.

Figure 1. Trends in Appropriation Accounts

The Flying Hour Program determines the requirements of the operating forces and justifies the resources provided through the Department of Defense Planning, Programming, Budgeting and Execution System (PPBES). The Navy designates Resource Sponsors to represent specific programs and navigate through the dynamics and complexities of the PPBES. The office that serves in this capacity for the FHP is the Office of the Chief of Naval Operations (OPNAV) N43 Fleet Readiness Division, specifically the N432D. N432D coordinates with the operating forces and supporting agencies to provide a well balanced FHP budget each year. The Aviation FHP Officers of N432D serve as the DoN resident experts on the FHP and are vital during the budget formulation process.

**B. PURPOSE**

Due to the complexity of the FHP, new officers assigned to N432D spend a large portion of their first year in this billet merely observing and learning their jobs. During this time, they may make mistakes due to a lack of familiarity with the overall scope of

their responsibilities. Errors when managing a budget the size of the FHP can result in the loss of millions of dollars and potentially affect readiness levels for Navy and Marine Corps squadrons.

The primary purpose of this professional report is to analyze the N432D Aviation FHP Officer's role and impact in the budget formulation process for the Navy FHP. This report serves as a comprehensive document on the responsibilities, tasks and key knowledge areas of the N432D Aviation FHP Officer, including examining key stakeholders in the FHP funding process and how N432D interacts with them. It starts by providing the reader with a good foundation on what the FHP is and how it fits into the Defense Resource Allocation Process of PPBES. The overall objective is to provide a ready reference for new Aviation FHP Officers to better prepare them for their duties and to improve their productivity during their first year in this billet.

## **C. RESEARCH QUESTIONS**

This project addresses the following research questions:

### **1. Primary Research Question**

What is N432D Aviation Flying Hour Program Officer's role and impact in the budget formulation process for the Navy Flying Hour Program?

### **2. Secondary Research Questions**

- a. What are the responsibilities and primary tasks of the N432D Aviation Flying Hour Program Officer?
- b. What key knowledge areas, skills and abilities are important to N432D Aviation FHP Officers?
- c. How does N432D manage stakeholders to minimize potential friction points? What type and amount of formal and informal communication is necessary between N432D and stakeholders to prepare a balanced budget and FHP plan?



## **D. METHODOLOGY**

The primary source of data collection for this study was through interviews with various members involved in the funding process of the Flying Hour Program (FHP). The majority of these interviews were with members of N432D who are the focus of this research. Equally important supporting information was gathered from the operating forces: Commander Naval Air Forces (CNAF) N407, Commander Naval Air Forces Atlantic (CNAL) N407, Commander Fleet Forces Command (CFFC) N402A, Headquarters Marine Corps Aviation Plans and Policy (HQMC APP-2), Commander Pacific Fleet (CPF) N00F, and Commander Naval Reserve Forces Command (CNRFC) N43B. Information gathered from OPNAV offices and Systems Commands include: OPNAV N80, OPNAV N81, OPNAV N82/FMB, Naval Supply Inventory Control Point (NAVICP), and Naval Air Systems Command (NAVAIR). The author conducted personal interviews with the majority of attendees at the July 2006, Flying Hour Conference and conducted follow on interviews via phone and email. Supporting data was obtained through briefing documents on the FHP, Data Call Instructions, Capabilities Plans, Sponsor Program Proposals, Operation Plan 20s (OP-20), Navy Instructions, Marine Corps Orders, and Naval Postgraduate School theses.

## **E. CHAPTER OUTLINE**

This MBA Professional Report contains five chapters.

Chapter I presents the background and purpose for this study. It also states the research questions and methodology.

Chapter II provides an overview of the Planning, Programming, Budgeting Execution System (PPBES) and an introduction to the Navy Flying Hour Program and its funding process.

Chapter III provides an analysis of key knowledge areas that are beneficial for new N432D Aviation FHP Officers. It transitions into examining N432D's role, tasks and responsibilities in funding the FHP. One of the essential tasks is managing the stakeholders of the FHP. This chapter provides an outline of N432D's interaction with the key FHP stakeholders.

Chapter IV provides an analysis of the FHP funding process in the PPBES and highlights N432D's role in guiding the process.

Chapter V answers the research questions addressed in the report and provides recommended topics for further research.

THIS PAGE INTENTIONALLY LEFT BLANK

## **II. THE NAVY FLYING HOUR PROGRAM AND DOD FUNDING PROCESS**

### **A. INTRODUCTION**

The Navy uses the Flying Hour Program (FHP) to program and budget for resources to train air crews and maintain Navy and Marine Corps aircraft. Numerous levels of FHP managers and comptrollers are involved in providing information to build the FHP budget. The managers generate the requirements in terms of hours needed to adequately train aircrews to the readiness levels set by the Navy and the Marine Corps. The comptrollers submit the cost data of operating and maintaining the aircraft, stated as cost per hour (CPH) and support costs, in dollars. These submissions from all stakeholders funnel to OPNAV N432D that has the ultimate responsibility of budgeting for future flying hours. This overly simplified description belies the fact that it is a highly complex process as it conforms to the DoD resource allocation process, the Planning, Programming, Budgeting, and Execution System (PPBES). Part of the complexity is due to the numerous agencies involved as they navigate through the DoD budgeting process. Therefore, the reader must have a basic understanding of the DoD budgeting process and of PPBES to understand the dynamics of the FHP process. The purpose of this chapter is to provide an overview of PPBES and the Navy FHP.

This chapter is divided into two sections. The first section gives an overview of the DoD budgeting process to give the reader the foundation to understand how all services submit their funding requirements. The second section gives an overview of the FHP, describes FHP funding, and introduces the organizations that manage the FHP.

### **B. PPBES OVERVIEW**

The Planning, Programming, Budgeting and Execution System is the system the Department of Defense uses to articulate strategy, set programming priorities, and allocate resources (Matthews, 2006, slide 14). This highly complex system was introduced to DoD in 1962 by Secretary of Defense Robert McNamara to improve upon the decentralized, duplicative, and inequitable budgeting process then in use in DoD. Then known as Planning, Programming, and Budgeting System (PPBS), it became the

primary resource management system of the DoD. PPBS achieved efficiencies and improvements in Government operations through establishing long range planning objectives, analyzing the costs and benefits of alternative programs that would meet those objectives, and translating programs into budget and legislative proposals and long-term projections (OSD Comptroller, 2006). During the past 44 years, three significant reform initiatives have influenced the PPBS: the Laird reforms, the Goldwater-Nichols Act, and the Rumsfeld transformation in 2001-2003. This study will just highlight the major impact of each reform since the details are too vast for the scope of this paper.

Melvin Laird replaced McNamara as Secretary of Defense in 1969. He sought to provide a better balance between military and civilian judgment in the defense decision-making process by providing better and earlier strategic and fiscal guidance to the services and the Joint Chiefs of Staff (JCS). (Defense Acquisition University, 2006) Whereas McNamara centralized defense fiscal decision-making with the civilians in the Office of the Secretary of Defense (OSD), Laird shifted the decision-making back to the Service Secretaries. This decentralized method gave the services the responsibility of balancing their program and budget against the Total Obligational Authority (TOA).

The Goldwater-Nichols Act of 1986 strengthened the role of the Chairman of the Joint Chiefs of Staff (CJCS) and created the position of the Vice Chairman of the Joint Chiefs of Staff. It is best known for creating combatant commanders (COCOM) as the warfighting entities, taking that responsibility away from the individual services which became responsible for training and equipping the operational forces. As a reflection of these changes, the COCOMs were heavily involved in programming, while the services hold most of the DoD Budget Authority.

During the reforms initiated by Secretary of Defense Donald Rumsfeld in 2001 to 2003, PPBS became PPBES with the emphasis on execution of the budget. While the basic structure of PPBS remained the same, it was changed in three important ways. First the reform merged separate programming and budget review into a single review cycle. Second, it incorporated a biennial budget process. Third, it changed the cycle for OSD provision of the top level planning information to the military departments and services (McCaffery & Jones, 2004, p. 93). With this two year budget cycle, the OSD provides

the Strategic Planning Guidance (SPG) on the “on-year”, and only provides guidance on “off-years” when changes to strategy are made.

The PPBES has two goals. The first is to provide the COCOMs with the best mix of forces, equipment, and support. The second is to buy the National Security Strategy (NSS) in a politically viable fashion (Matthews, 2006, slide 4). The NSS is the document that lays out the broad strategic vision of the President. Part of the reasons why PPBES is so complex is because it is highly politicized. Congress, as the sole authority to tax and spend, ultimately must approve the President’s Budget (PB) to achieve the NSS. Policy development and resource planning are inextricably linked to constituent politics in defense planning (McCaffery & Jones, 2004, p. 103).

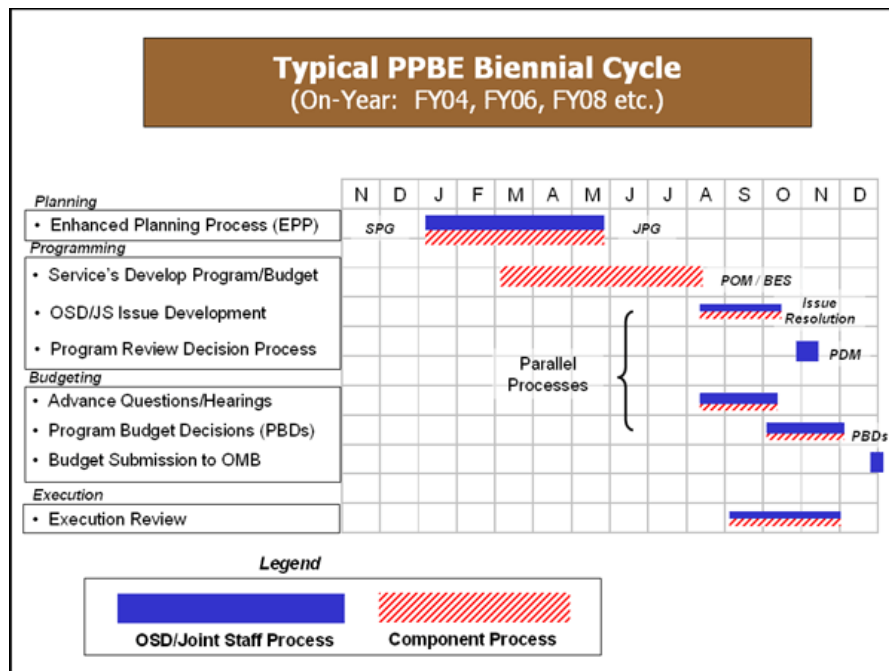

Figure 2. PPBE Biennial Cycle “On-Year”

Source: Defense Acquisition University, *Defense Acquisition Guidebook*. <http://www.deskbook.osd.mil/dag/GuideBook/IG c1.2.asp>. 2006.

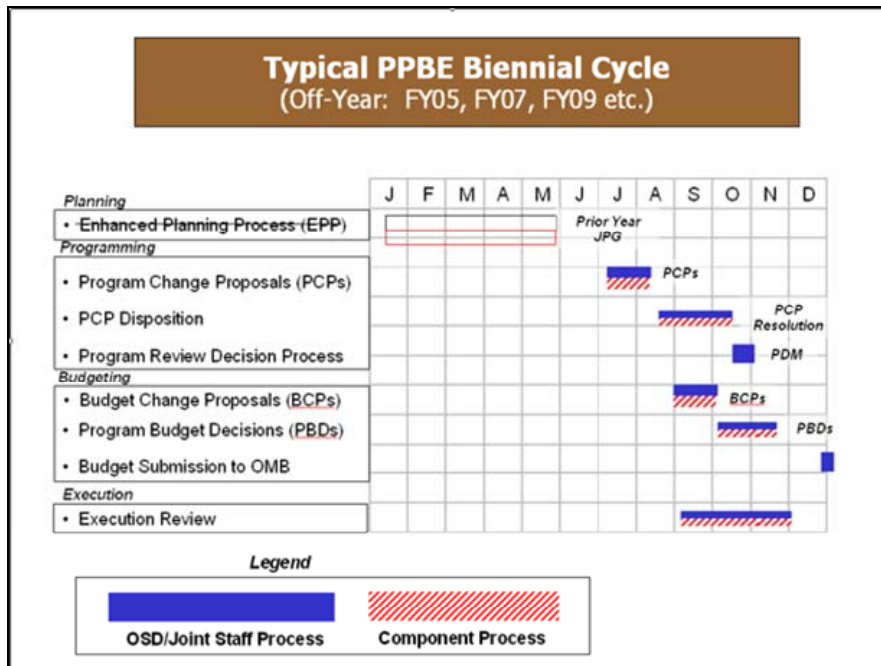

Figure 3. PPBE Biennial Cycle “Off-Year”

Source: Defense Acquisition University, *Defense Acquisition Guidebook*.  
<http://www.deskbook.osd.mil/dag/GuideBook/IG c1.2.asp>. 2006.

### 1. Planning

The planning phase of PPBES is a joint effort by the OSD and JCS. The JCS produce a National Military Strategy (NMS) in response to the NSS detailing the strategic aims of the armed forces. The Secretary of Defense (SECDEF) utilizes the NSS and NMS to produce the Strategic Planning Guidance (SPG) to lead the planning process, now known as the Enhanced Planning Process (Defense Acquisition University, 2006, p 1.2) This process results in fiscally constrained guidance and priorities - for military forces, modernization, readiness and sustainability, and supporting business processes and infrastructure activities - for program development in a document known as the Joint Programming Guidance. The Joint Programming Guidance is the link between planning and programming, and it provides guidance to the DoD Components (military departments and defense agencies) for the development of their program proposal, known as the Program Objective Memorandum (POM) (Defense Acquisition University, 2006, p. 1.2).

## **2. Programming**

The programming phase starts when the services start to build their POMs for their proposed programs. The POM is best described as each Service's plan for the resources needed to accomplish the programs and missions forecasted for the next six years. Every two years during the even years<sup>1</sup>, the POM is updated to reflect: 1) new missions, 2) new objectives, 3) alternative solutions, 4) allocation of resources, 5) ongoing DoD activities, and 6) the forecasted costs of each program (Keating & Paulk, 1998, p. 15). The Joint Chiefs of Staff (JCS) review the POM of each service to ensure that they comply with the National Military Strategy (NMS) and the Strategic Planning Guidance (SPG). The Chairman of the Joint Chiefs of Staff (CJCS) checks for balance in the POM of each service, then makes recommendations to the SECDEF in the form of the Chairman's Program Assessment (CPA). Once the SECDEF issues the Program Decision Memoranda (PDM) approving or modifying each POM, the programming phase is complete.

## **3. Budgeting**

Due to Rumsfeld's reforms, the budgeting phase is concurrent with the programming phase. Each service estimates a cost associated with the resources detailed in the POM. This total cost estimate is submitted to OSD on even years<sup>2</sup> as the Budget Estimate Submission (BES). Unlike the POM which has six years of information, the BES only has two years. However, this information is much more detailed as it contains more financial information. Once the services finalize their BES, they submit it for a joint review by analysts from the Office of the Under Secretary of Defense (USD) Comptroller and the Office of Management and Budget (OMB). This review ensures compliance with the National Security Strategy (NSS), the Strategic Planning Guidance (SPG), the Joint Programming Guidance (JPG), and the Program Decision Memorandum (PDM). The review also seeks to ensure that programs are funded in accordance with current financial policies, and are properly and reasonably priced. The OSD level of

---

<sup>1</sup> On odd years, a Program Change Proposal (PCP) may be submitted for urgent changes. PCPs are also commonly known as Program Reviews (PR).

<sup>2</sup> On odd years, a Budget Change Proposal (BCP) may be submitted to reflect fact of life changes such as cost increases and schedule delays.



review results in the drafting of the Program Budget Decision (PBD). In the PBD, the analysts can take three courses of action: 1) approve exhibits as presented, 2) disapprove portions of exhibits by issuing a “mark”, or 3) approve additional funds where shortfalls are detected (Keating & Paulk, 1998, p. 17). The PBD remains a draft until the services have the opportunity to review and reclama (Candrea, 2004, p. 68). The reclama is a justification by the program sponsor in response to the marks made by the budget analyst. It is unbiased and addresses only factual disagreements stated by the analyst. A good reclama addresses the logic and data used by the analyst that led them to conclude the mark was an appropriate adjustment (Candrea, 2004, p. 67). If the analyst agrees with the reclama, the mark is removed. If not, the budget is reduced. It should be noted that marks that are unanswered result in a budget reduction once the deadline for reclaims has past. The final DoD budget is then submitted to OMB to become part of the President’s Budget, which marks the end of the budgeting phase.

#### **4. Execution**

Once Congress appropriates funds to DoD, DoD cannot start spending until it completes the allotment process. The reason for this is that appropriated funds may be different from what the services budgeted. In the allotment review, the services have to show how they will spend the appropriated amounts by quarters. Once OMB and the Treasury approve this revised budget, DoD allocates funds to the different services. The services now have Budget Authority, meaning the legal authority to incur obligations and make payments out of the U.S. Treasury for specified purposes (American Society of Military Comptrollers, 2005, p 1.1.23). They may now make obligations<sup>3</sup> and outlays.<sup>4</sup> At the midpoint of the fiscal year, the services conduct a midyear review to analyze their obligation and expenditure rates and to ensure that funding levels are adequate. The purpose is to determine if transfers or reprogramming of funds are necessary. At the end of the fiscal year, each Service reconciles their accounts with appropriations to ensure that they did not overspend, thereby resulting in an Anti-Deficiency Act violation. Table 1 summaries the phases of PPBES.

---

<sup>3</sup> A contract or a legal obligation to pay.

<sup>4</sup> An expenditure of funds to pay for the obligation.

<b>Phases of the PPBES</b>			
<b>Planning</b>	<b>Programming</b>	<b>Budgeting</b>	<b>Execution</b>
	Concurrent		
<ul style="list-style-type: none"> <li>• Assess Threat</li> <li>• Develop Strategy</li> </ul>	<ul style="list-style-type: none"> <li>• Develop 6-Year Plan</li> </ul>	<ul style="list-style-type: none"> <li>• Emphasize first 2 years of 6-Year Plan</li> </ul>	<ul style="list-style-type: none"> <li>• Current Year Obligations and Outlays</li> </ul>
<b>Outputs</b> <ul style="list-style-type: none"> <li>• National Military Strategy (NMS)</li> <li>• Strategic Planning Guidance (SPG)</li> <li>• Joint Programming Guidance (JPG)</li> </ul>	<b>Outputs</b> <ul style="list-style-type: none"> <li>• Program Objective Memoranda (POM)</li> <li>• Future Years Defense Program (FYDP)</li> <li>• Program Decision Memoranda (PDM)</li> </ul>	<b>Outputs</b> <ul style="list-style-type: none"> <li>• Budget Estimate Submission (BES)</li> <li>• Program Budget Decision (PBD)</li> <li>• President's Budget (PB)</li> </ul>	<b>Outputs</b> <ul style="list-style-type: none"> <li>• Allotment Review</li> <li>• Midyear Review</li> </ul>

Table 1. Phases of the PPBES.

Source: Keating & Paulk, 1998, p. 19.

### C. THE NAVY FLYING HOUR PROGRAM OVERVIEW

The Navy Flying Hour Program provides the required resources for Navy and Marine aviation forces to train in prescribed readiness areas, perform flights in support of required maintenance and logistical efforts, and conduct routine deployed operations (OPNAV, 2005, p. 1). The FHP provides these resources to active duty and reserve units of the Navy and the Marine Corps. The four major claimants, also known as Budget Submitting Offices (BSO), that receive these resources are Commander Atlantic Fleet (COMLANTFLT), Commander Pacific Fleet (COMPACFLT), Commander Naval Forces Europe (COMNAVEUR), and Commander Naval Reserve Forces (COMNAVRESFOR). Other important commands for Naval Aviation include Naval Air Systems Command (NAVAIR) and Chief of Naval Air Training (CNATRA). NAVAIR provides advance warfare technologies for Naval Aviation and CNATRA trains all entry level pilots, Naval Flight Officers, and enlisted aircrew. However, the FHP does not cover the aviation related costs of these commands since they do not directly address Fleet readiness.

## 1. FHP Funding

The FHP is the largest budget within the Department of the Navy (DoN) exceeding \$4.95 billion dollars in Fiscal Year (FY) 2006. Funding for the FHP comes from the two appropriations of Operation and Maintenance, Navy (OMN) and Operation and Maintenance, Navy Reserve (OMNR). The FHP budget is made up of the sub-activity groups of 1A1A Mission and Other Flight Operations and 1A2A Fleet Air Training from OMN, and from sub-activity group 1A1A Mission and Other Flight Operations from OMNR. This amount represents 15.5 percent of the combined OMN and OMNR appropriations for FY 2006 (Department of the Navy Financial Management and Comptroller Webpage, 2006). These appropriations provide the resources to train Fleet aircrews and support the operating forces in non-combat environments only. Flight operations in combat receive funding from Regular and Supplemental Appropriations and are not a part of the FHP. Additionally, it should be mentioned that these are Blue dollars only, meaning that the Marine Corps submits its requirements to the Navy. When the three Air Type Commanders (TYCOMs) of Commander Naval Air Forces Pacific (CNAP), Commander Naval Air Forces Atlantic<sup>5</sup> (CNAL), and Commander Naval Air Forces Reserve (CNAFR) receive their funds, they allocate the Marine Corps' share to Marine Forces Pacific (MARFORPAC), Marine Forces Atlantic (MARFORLANT), and Marine Forces Reserve (MARFORRES). This funding is broken down to support four schedules:

- Schedule A: Tactical Aircraft (TACAIR). OMN sub-activity group 1A1A finances TACAIR. This category funds all Navy and Marine Corps deployable squadrons that serve as the operating forces ready to support national objectives. TACAIR requirements state the minimum number of flight hours needed to maintain the appropriate training/combat readiness level. Since TACAIR makes up the majority of the FHP it is the easiest target for budget cutbacks (N432D, 2006).

---

<sup>5</sup> Commander Naval Air Forces Europe submits their requirement and receive their funding through CNAL

- Schedule B: Fleet Air Training (FAT). OMN sub-activity group 1A2A finances FAT. This category provides funding for Navy and Marine Corps training squadrons, known as Fleet Replacement Squadrons (FRS), after completion of basic flight training. It also funds the Naval Strike and Air Warfare Center (NSAWC) which is the primary authority on training and tactics development. Besides funding the aircrew training, FAT also funds the operation and maintenance of flight simulator facilities.
- Schedule C: Fleet Air Support (FAS). OMN sub-activity group 1A1A finances FAS. The mission of the FAS is to provide fleet tactical, strategic and other miscellaneous direct and indirect support (including logistics) to Navy and Marine Corps operating forces and shore establishments (OPNAV, 1996, p. 4-1). FAS funds the flight hours for squadrons in the combat support role.
- Schedule D: Reserve. OMNR sub-activity group 1A1A finances the Reserve component. Navy and Marine Corps Reserve squadrons are an integral part of naval aviation. This category funds the required flight hours to maintain the readiness of all reserve squadrons, both tactical and logistical support.

Ultimately, the Flying Hour Program (FHP) is the process that converts the requirements of the major claimants into a budget to provide the resources. It is the DoN means to forecast, budget and justify the funds required for active general purpose aviation forces (Navy and Marine Corps), reserve aviation forces (Navy and Marine Corps), and strategic communication forces (TACAMO). TACAMO (Take Charge and Move Out) is a Navy wing of 16 E-6Bs that are strategic assets assigned to joint operations. They are funded through the FAT and FAS schedules.

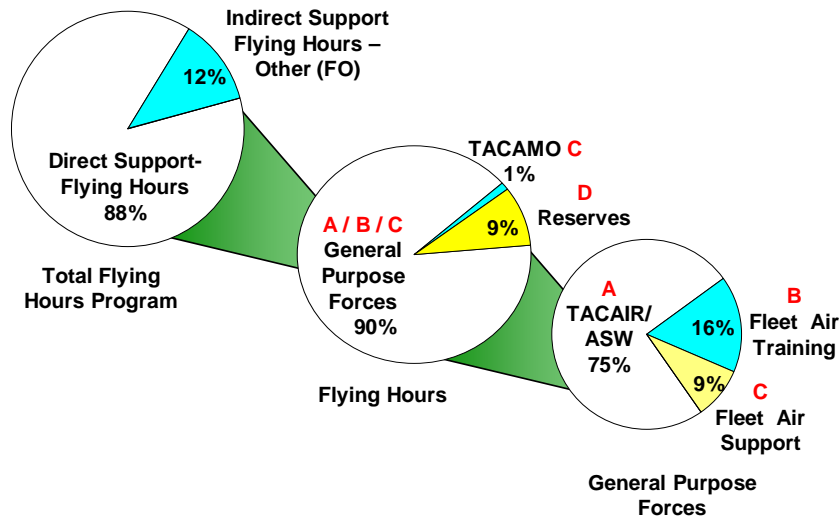

Figure 4. Scope of the Flying Hour Program

Source: EDO Corporation, Flying Hour Other (FO) Brief, 2004, slide 6.

Funding from the sub-activity groups of 1A1A and 1A2A are broken into Operational Target Functional Categories (OFCs), also known as Operating Targets (OPTARs), to provide specific use of funds, direct or indirect support, and the type of support the funding provides (U.S. Marine Corps, 2005, p. 1). Figure 4 represents how the budget is distributed between direct costs and the indirect cost category of Flying Hours Other (FO). Direct support funds are divided into two OFCs, OFC-01 and OFC-50.

OFC-01, also known as Aircraft Flight Operations (AFO), is for organizational/squadron level of funding. It consists of fund codes 7B for aviation fuels and 7F for flight equipment and administrative supplies in direct support of flight operations and aircraft maintenance.

OFC-50, also known as Aircraft Operations Maintenance (AOM), is for Intermediate Maintenance Activity (IMA) and Organizational Maintenance Activity (OMA) level of funding. These funds support Navy and Marine Aircraft Groups, Naval

Air Station Aircraft Intermediate Maintenance Departments, and aircraft carrier (CV) class ships maintenance departments (U.S. Marine Corps, 2005, p. 2). It consists of fund codes 9S for Aviation Depot Level Repairable (AVDLR) and 7L for Aviation Fleet Maintenance (AFM). AVDLRs are major components of the aircraft, such as an engine beyond the maintenance capability of the OMA and IMA, which are shipped to depot level repair. AFM funding is spent on consumables such as oil, lubricants, consumable parts, etc.

During the Execution Phase, each major claimant receives its Budget Authority representing the limit that they may incur obligations for the year. COMPACFLT, COMLANTFLT and COMNAVRESFOR receive their FHP funding and further allocate it down to the squadron, carrier and station levels in the forms of the OFC-01 and OFC-50. As the commands incur obligations and make outlays, it is recorded in a Flying Hour Cost Report (FHCR). This document is the key source for cost data for future FHP budgets.

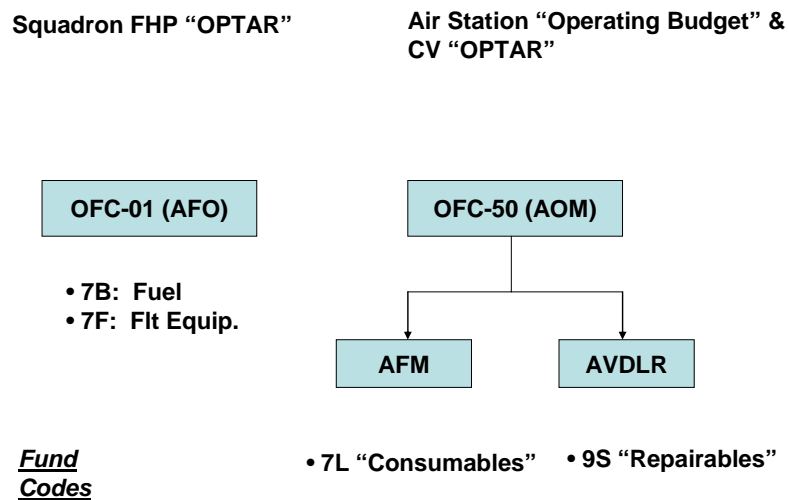

Figure 5. FHP Funding Composition

Source: Keating & Paulk, 1998, p. 34.

## **2. Management of the Flying Hour Program**

The Vice Chief of Naval Operations, the Deputy Chiefs of Naval Operations, and a number of other ranking officers along with their respective staffs are collectively known as the Office of the Chief of Naval Operations (OPNAV). These special staff functions serve the CNO in his role as the principal naval advisor to the President and to the Secretary of the Navy (SECNAV) on the conduct of war and as the principal advisor and naval executive to the Secretary on the conduct of naval activities of the Department of the Navy (U.S. Navy Webpage, 2006). OPNAV contains the Resource Sponsors for various functions to include the FHP. In the past ten years, management of the FHP has been restructured three times from the Director of Manpower and Training N889, to Aviation Warfare N78, to Fleet Readiness N43 in 2004. Since the FHP ultimately buys readiness, N43 is well suited to manage it, thereby freeing the warfare specialists to focus on warfighting functions. As the Resource Sponsor for the FHP, N43 is responsible for ensuring that sufficient flying hours are budgeted to achieve operational and readiness objectives. This responsibility is further delegated down to N432D Aviation FHP. Figure 6 is an OPNAV N4 organization chart. Although N43 is the Resource Sponsor for the FHP, numerous other sections within the OPNAV structure are involved in the budgeting process. Figure 7 depicts the action officers who are responsible for the minute details of programming and budgeting the FHP. Chapter III provides the details of how these stakeholders contribute to funding the FHP.

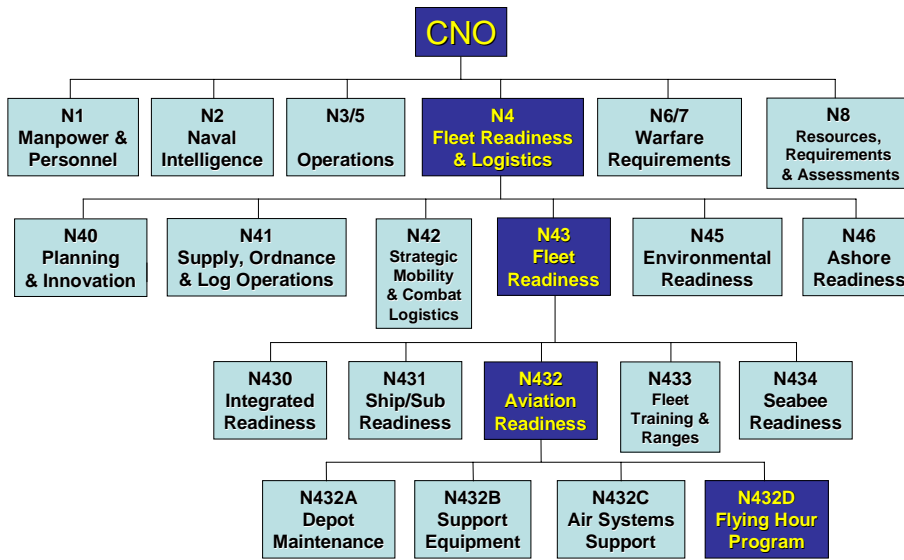

Figure 6. Readiness and Logistics Organization

Source: OPNAV, 2006d, slide 15.



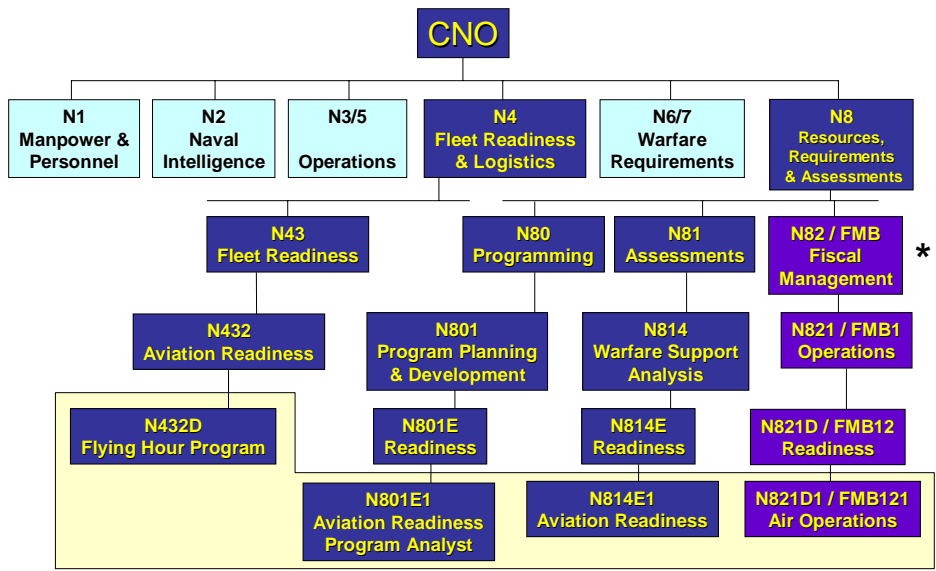

Figure 7. OPNAV FHP Action Officers

\* Fiscal Management Branch works for the SECNAV during budgeting and for the CNO during execution.

Source: OPNAV, 2006d, slide 16.

#### D. CHAPTER SUMMARY

This chapter provides an overview of the PPBES and FHP processes. An understanding of the PPBES and FHP is necessary to comprehend the content in the following chapters. These topics are highly complex, so the objective here was to highlight key areas of importance and to lay out the background foundation before examining the roles and responsibilities of N432D Aviation FHP Officers.

### **III. OPNAV N432D AVIATION FLYING HOUR PROGRAM OFFICER ROLES AND RESPONSIBILITIES**

#### **A. INTRODUCTION**

Chapter II provided an overview of the PPBES and the FHP processes. It also identified N432D as the agency that is responsible for ensuring that the FHP is properly balanced between requirements and monetary constraints. This chapter starts with an examination of key knowledge areas that are beneficial for new Aviation FHP Officers to have before serving in N432D. This is followed by a detailed definition of the role of N432D and the primary responsibilities and tasks of the job. Finally, this chapter examines the stakeholders of the FHP funding process and N432D interaction with them.

#### **B. KEY KNOWLEDGE AREAS**

In the corporate world, a position that manages almost five billion dollars would require an impressive resume filled with vast financial experience and training. The Navy does not have defined prerequisites for assignment to N432D. This section evaluates what skills and knowledge areas that new Aviation FHP Officers in N432D should have to be successful in their duties.

##### **1. Aviation Background**

A highly important knowledge area for Aviation FHP Officers is Naval Aviation. Understanding the missions and roles of aircraft types and how aircrews train is highly relevant when budgeting to provide the resources for these requirements (N432D, 2006). There are two primary reasons why it is important to have an aviation background: the first is to understand the Navy Training and Readiness (T&R) Matrix and the second is to understand the logistics of maintaining aircraft.

The Naval Aviation Training and Readiness (T&R) Matrix is essential for determining how many flying hours squadrons need to maintain their readiness rating. CNAF uses the T&R Matrix as an input to its model when calculating flying hours (CNAF FHP member, 2006). This matrix is common knowledge to aviators since they have been exposed to it since the beginning of their flight training and it continues to

drive all of their peace time flights. However, it is completely foreign to non-aviators thus creating a disadvantage for them as they must learn how the T&R Matrix works.

An aviation background gives the Aviation FHP Officer a good understanding of what drives cost per hour (CPH) rates for the different Special Interest Codes that refer to aircraft maintenance (evaluated in Section C-1-a of this chapter). Non-aviators do not have the experience of maintaining an aircraft, thus they are handicapped in dialogue about costs with budgeters from the BSOs.

## **2. Financial Management MBA Background**

The majority of officers joining N432D have a Financial Management MBA from the Naval Postgraduate School (NPS). Those who do not are in the process of getting it through the NPS Non-Resident Program. This is key knowledge for new Aviation FHP Officers because it gives a firm foundation in knowledge areas such as PPBES, defense acquisition, cost estimation, and modeling.

The Financial Management curriculum includes classes on defense budgeting that detail the PPBE process. The importance of this knowledge was highlighted in Chapter II and is further explained in Chapter IV with respect to how the FHP fits into the PPBE process. This foundation is essential since the PPBES is the resource management system within which N432D operates.

Defense acquisition is an important knowledge area because Aviation FHP Officers need to understand the process in which program managers operate. The acquisition field includes new aircraft such as the Joint Strike Fighter and the V-22 Osprey. Aviation FHP Officers need to understand the procurement process and be in contact with the program managers to be prepared for future costs of sustaining these aircraft. On a smaller scale, changes to existing systems mean cost adjustments that affect the CPH of that particular Type/Model/Series (T/M/S) of aircraft. The defense acquisition foundation better prepares new Aviation FHP Officers for their interaction with program managers.

Another key skill for Aviation FHP Officers is cost estimation. N432D does not do cost estimates because it receives refined CPH data from the BSOs for input to their Flying Hour Projection System. However, the ability to do cost estimates allows N432D

to verify if it received good data from the BSOs. If a CPH input looks suspicious, N432D will have the knowledge background on how to question the BSO and determine how they generated that CPH.

A basic understanding of modeling is important because of the different modeling programs that are used by N432D and the Air TYCOMs to generate flying hour requirements. The level of knowledge only needs to be at the user level since other organizations such as the Naval Sea Logistics Center (NAVSEALOGCEN) and General Dynamics are responsible for the programming support. N432D needs to articulate to the information technology specialists what they need the models to do. A basic background on modeling helps in this interaction so that the Aviation FHP Officer has a basic understanding of the capabilities and limitations of modeling programs.

### **3. Section Summary**

This section lists several knowledge areas that are beneficial for new Aviation FHP Officers. However, it must be noted that there have been successful Aviation FHP Officers who did not have an MBA degree or have a background in aviation. However, these knowledge areas serve as building blocks that make it easier for new members of N432D to get started in their billet and to speed up the learning curve so as to improve operational efficiency, and do so more quickly.

### **C. OPNAV N432D PRIMARY TASKS**

A sub-section of OPNAV N432 Aviation Readiness, N432D is comprised of two Aviation FHP Officers and a small supporting staff. It serves as the focal point for all functions related to the development of FHP funding. N432D is responsible for maintaining the Flying Hours Projection System (FHPS), developing budget back-up exhibits and reviewing current year execution (OPNAV, 1996, p. 1-2). It is the resident expert on requirements and costs that ultimately goes into creating the POM by N80 and the BES by FMB. To do so, N432D maintains close liaisons with all FHP stakeholders because it depends on timely and accurate information from all major contributors to the FHP. This relationship is especially close with the major claimants since N432D serves as their representative once it accepts their requirements as valid.

N432D is an integral part of the FHP funding loop. Figure 8 reflects how the Air TYCOM requirements are the inputs into the POM and BES that ultimately result in a congressionally approved budget. The BSOs uses the resources during budget execution to attain specified readiness levels. The achieved readiness levels and its cost report are fed back into the loop to form the baseline CPH for future budgets.

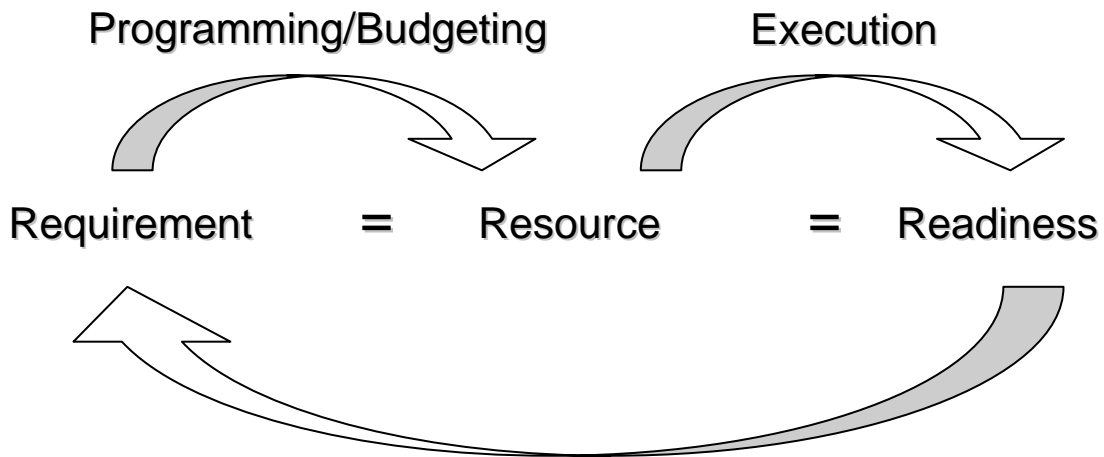

Figure 8. FHP Feedback Mechanisms

Source: OPNAV, 2006d, slide 3.

The feedback loop described above occurs within each federal budget cycle. The budget formulation within the federal budgeting cycle starts as early as 21 months prior to the fiscal year in which the budget will be executed (American Society of Military Comptrollers, 2005, p. 1.1.18). This time allows the services to develop their BES for submission to OSD and OMB to ultimately build the President’s Budget. It also counts time required for congressional action to develop and pass the National Defense appropriations bill for the President’s signature into law to fund DoD. Thus, the tasks of N432D can span over four different fiscal years as shown in Figure 9.

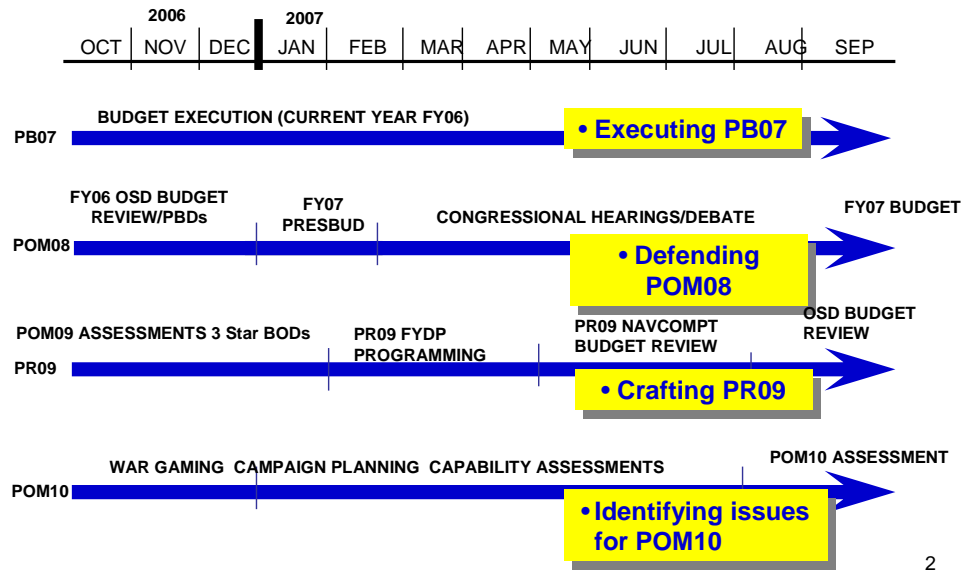

Figure 9. Budget Process Overlap

Source: Crenshaw, 2006, slide 2.

### 1. Management of the Flying Hour Projection System (FHPS)

The FHPS is the model that captures, stores, tracks, and projects FHP costs, flight hours, and aircraft inventory to produce required budget exhibits (OPNAV, 2006a, slide 3). This data base is physically located at Naval Sea Logistics Center (NAVSEALOGCEN) at Mechanicsburg, PA. NAVSEALOGCEN provides the information technology support to N432D who manages the data base. N432D uses the data base information of current and historical data to build future year flying hour requirements across the Future Years Defense Program (FYDP).

#### a. Inputs to the FHPS

N432D requires three input variables for the FHPS; force structure, required flying hours, and pricing (N432D, 2006). The force structure provides the number of aircraft by Type/Model/Series (T/M/S) available for the budgeted year.

CNAF, Headquarters Marine Corps Aviation Plans and Policy (HQMC APP), and CNAFR provide N432D their warfare training requirements stated in flying hours. These agencies represent Navy Aviation, Marine Corps Aviation and Reserve Aviation (Navy and Marine Corps) respectively. For pricing, the BSOs of COMPACFLT, COMLANTFLT and COMNAVRESFOR provide the information in terms of cost per hour in dollars to N432D. Normally, the submission of the pricing data is through the FHCR discussed in Chapter II. Due to the length of the of the federal budgeting cycle, N432D uses certified data of a particular fiscal year to serve as the baseline for projected costs for the fiscal year three years in the future. For example, FY 2006 certified costs serve as the baseline for FY 2009.

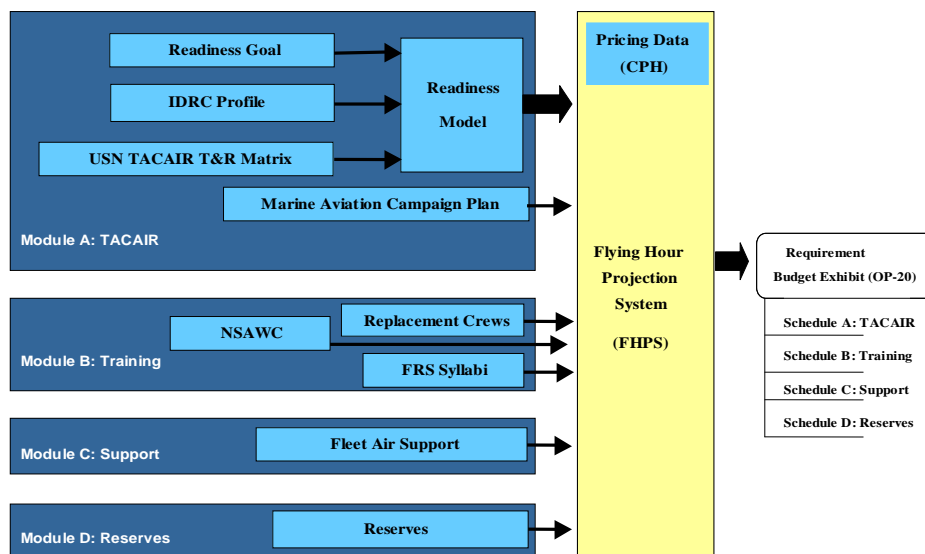

Figure 10. Flying Hour Projection System

Source: OPNAV, 2004, p. 5.

Figure 10 represents the FHPS with its four supporting modules/schedules. These modules contain the various factors that affect how many flying hours are required. The total flying hour requirement combined with the CPH determines future years flying hours in the form of Budget Exhibit OP-20. The composition of each module is as follows:

- Module A is the TACAIR readiness component. This component provides the number of hours per crew per month for each carrier based, Helicopter Antisubmarine Warfare Light, and Patrol T/M/S to generate the required level of readiness over the Inter-Deployment Readiness Cycle (IDRC). The model incorporates the CNO's readiness goals, the CNAF T&R Matrix, and the Inter-Deployment Readiness Profile. The Marine Aviation Campaign Plan (MACP) data is also included in this component (OPNAV, 2004, p. 5).
- Module B is the Fleet Air Training component. This component accounts for the flying hour requirement in two areas of fleet training; the Fleet Readiness Squadrons (FRS) and Naval Strike and Air Warfare Center (NSAWC). The FRS accounts for over 95 percent of Fleet Air Training. The Chief of Naval Personnel determines the number of replacement crews required by the Fleet. This information is used by the CNATRA Naval Aviator Production Process (NAPP) to determine the number of crews that must be cycled through the training pipeline annually. The NAPP generates the Integrated Production Plan (IPP) that depicts the number of replacement crews that must be trained by each FRS annually. This number is multiplied by the number of flying hours in the OPNAV approved FRS syllabus for each T/M/S. The result is the number of hours required for each FRS through the FYDP (OPNAV, 2004, p. 6).
- Module C is the Fleet Air Support component. Flying Hours for FAS units are driven by the Worldwide Logistics Conference and the Fleet



schedule for logistics platforms, and by the Regional COCOMs for reconnaissance platforms. A historical baseline is used to perpetuate the annual flying hours executed by these platforms (OPNAV, 2004, p. 6).

- Module D is the Reserve component. The requirement for this component is a combination of the TACAIR methodology and the FAS methodology (OPNAV, 2004, p. 6).

The Cost Per Hour (CPH) is a very important element of the FHPS. In order to generate reliable outputs, N432D must have accurate and detailed pricing data from the BSOs. At the end of a fiscal year, BSOs submit a thirteenth month FHCR that they have verified by subtracting cost adjustment factors and cost of war factors. This provides a historical aggregate cost that is used as the baseline to create or adjust CPH inputs for future budgets. Figure 11 shows the pricing methodology starting with the historical costs that is determined for each T/M/S.

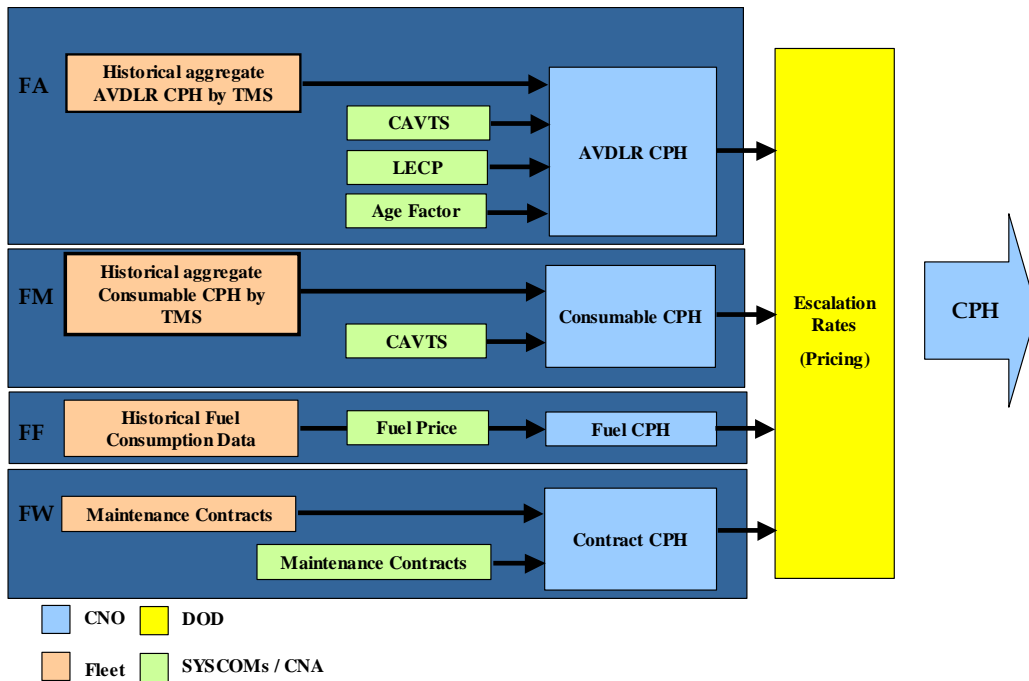

Figure 11. Pricing Methodology for Cost Per Hour

Source: OPNAV, 2004, p. 6.

Special Interest Codes (SIC) are assigned to each pricing component of the FHPS. Each SIC starts with the historical aggregate and adjusts the CPH with different adjustment factors from System Commands (SYSCOM) or the Center for Naval Analysis (CNA).

<u>SIC</u>	<u>Cost</u>	<u>Category</u>
FA	Direct	Aviation Depot Level Repairables
FM	Direct	Maintenance Consumables
FF	Direct	Fuel
FW	Direct	Contracts
FO	Indirect	Flying Hour Support <sup>6</sup>

Table 2. Special Interest Codes

Taking code FA for Aviation Depot Level Repairables as an example, the historical cost is adjusted according to the Cost Adjustment Visibility Tracking System (CAVTS), the Logistics Engineering Change Proposal (LECP) and the Age Factor. CAVTS is a web-tool process used to identify future FHP cost drivers, track actual execution, and improve the feedback mechanisms in order to better prepare and forecast future FHP budgets (Naval Air Systems Command, 2006). A LECP is a reliability or maintainability related Engineering Change Proposal (ECP) for a Naval Inventory Control Point (NAVICP) managed item designed to reduce or eliminate support costs while maintaining or improving safety and performance (Department of the Navy Acquisition One Source Webpage, 2006). The historical aggregates adjusted by the SYSCOM/CNA inputs produce the CPH for each SIC. Each SIC is then multiplied by the escalation rates given by FMB to produce the CPH factor for each T/M/S.

---

<sup>6</sup> FO models are not currently validated and are not part of the FHPS.

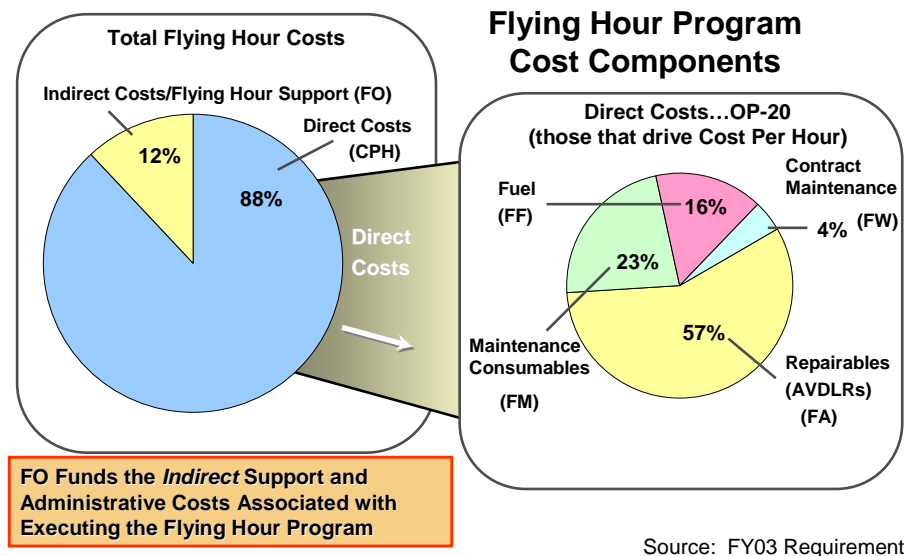

Figure 12. Flying Hour Costs

Source: EDO Corporation, 2004, slide 6.

**b. Operational Plan 20 (OP-20)**

The principal product of the FHPS is the OP-20 Budget Exhibit. Throughout the year, N432D produces numerous versions of the OP-20. It serves as both a budget formulation tool and an execution monitoring tool. During budget formulation, N432D continuously updates cost inputs into the FHPS to generate new OP-20s. These OP-20s reflecting the Air Type Command (TYCOMs) requirements inevitably exceed the top-line budget figure. How OPNAV and the TYCOMs make up for this shortfall is described in Chapter IV. As an execution monitoring tool, N432D publishes a final execution OP-20 that summarizes the program execution costs of the previous year (Keating & Paulk, 1998, p. 73).

The major claimants and Air TYCOMs use the OP-20 to prepare their budget, allocate flight hours, and estimate costs for the fiscal year. They use the version of the OP-20 that supports the POM for guidance in preparing their budget submissions.

Congress appropriates funding for flight hours for DoD based on a formula that is renegotiated periodically. Once the defense appropriation and authorization bills are approved by Congress, funds are allocated to the major claimants for further allocation to individual squadrons. The major claimants then use this Execution OP-20 to guide their execution of funds.

The OP-20 exhibit displays the Major Force Program (MFP),<sup>7</sup> program element, T/M/S, flying hour requirement and cost per hour by Special Interest Codes. This adds up to a total cost per hour for each T/M/S as well as a total cost per year.

UNCLASSIFIED		Department of the Navy (DON) OP-20										Page 2 of 14	
FY: 2011		Analysis of Navy Flying Budget BackUp Exhibit										09/21/2006	
Version: 1729 07-033-87 -BE (BUDGET ESTIMATE SUBMISSION)													
GEN PURPOSE FORCES		----- Cost Per Hour -----											
Program Element	TMS	Forces	Util	Hours	----- Annual Cost, in Millions -----						Total	Hrly Fuel Cons Rate	
					FF/Fuel	FA/DLR	FM/Maint	FW/CONTRACT	FO/OTHER	ADJ			
0206110 M	AV-8B	91.0	22.353	24409	836.60	4599.68	1662.23	0.00	0.00	0.00	7098.51	18.975	
					20.421	112.274	40.573	0.000	0.000	0.000	173.269		
	JSF	7.0	0.000	0	0.00	0.00	0.00	0.00	0.00	0.00	0.00	0.000	
					0.000	0.000	0.000	0.000	0.000	0.000	0.000		
<b>PE 0206110M TOTAL:</b>		<b>98.0</b>	<b>20.756</b>	<b>24409</b>	<b>836.60</b>	<b>4599.68</b>	<b>1662.23</b>	<b>0.00</b>	<b>0.00</b>	<b>0.00</b>	<b>7098.51</b>	<b>18.975</b>	
					20.421	112.274	40.573	0.000	0.000	0.000	173.269		
0206121 M	CH-46E	60.0	20.254	14583	206.83	2522.15	1509.88	0.00	0.00	0.00	4238.86	4.691	
					3.016	36.781	22.019	0.000	0.000	0.000	61.815		
	MV-22B	86.5	22.896	23766	576.26	2739.96	1152.54	0.00	0.00	0.00	4468.76	13.070	
					13.695	68.118	27.391	0.000	0.000	0.000	106.205		
<b>PE 0206121M TOTAL:</b>		<b>146.5</b>	<b>21.814</b>	<b>38349</b>	<b>435.78</b>	<b>2657.13</b>	<b>1288.43</b>	<b>0.00</b>	<b>0.00</b>	<b>0.00</b>	<b>4381.34</b>	<b>9.884</b>	
					3.016	36.781	22.019	0.000	0.000	0.000	61.815		

Figure 13. OP-20 Example

Source: Department of the Navy DON-OP-20 Analysis of Navy Flying Budget Backup Exhibit, 2006.

As the manager of the FHPS and the OP-20, N432D is the Navy resident expert on budgeting impacts to the FHP. As such, flag officers and other OPNAV sections often consult with N432D for impacts of proposed changes to FHP funding. N432D inputs these changes into the FHPS to create the resulting OP-20 for these “what

<sup>7</sup> The FHP programs and budgets O&M, N and O&M, NR funds for four of the 11 DoD MFPs. The four are Strategic Forces, General Purpose Forces, Intelligence and Communications, and Guard and Reserves.

if” drills. The decision making authorities consider these results before deciding to reprogram or transfer funds to or from the FHP.

## **2. Management of Stakeholders**

As the section responsible for developing FHP funding, N432D must coordinate with multiple agencies to produce equitable OP-20s. At over 4.95 billion dollars for FY 2006, the FHP has numerous stakeholders in the budget formulation. This includes the American populace and their representatives in Congress. To stay within the scope of this study, this section deals only with stakeholders that N432D coordinates with on a regular basis.

### ***a. Navy Aviation***

In October 2001, the CNO placed TYCOMs in a “Lead-Follow” arrangement (CNAF Webpage, 2006). Under this arrangement, Commander, Naval Air Forces Pacific (CNAP) assumed the additional title of Commander, Naval Air Forces (CNAF). Although CNAP and Commander, Naval Air Forces Atlantic (CNAL) both have FHP managers, the CNAF/CNAP FHP Manager became the sole source for submitting requirements to N432D. The CNAP and CNAL FHP Managers redistributed their responsibilities to provide mutual support. The CNAL FHP Manager is responsible solely for FHP execution as he allocates entitlements to all squadrons and installations from the Execution OP-20 (CNAL FHP member, 2006). The CNAP FHP Manager serves as the CNAF FHP Manager who focuses on programming future flying hour requirements and quantifying the impact of budgeting (CNAF FHP member, 2006). The primary tool the CNAF FHP Manager uses is the Flying Hour Resource Model (FHRM).

# Flying Hour Program

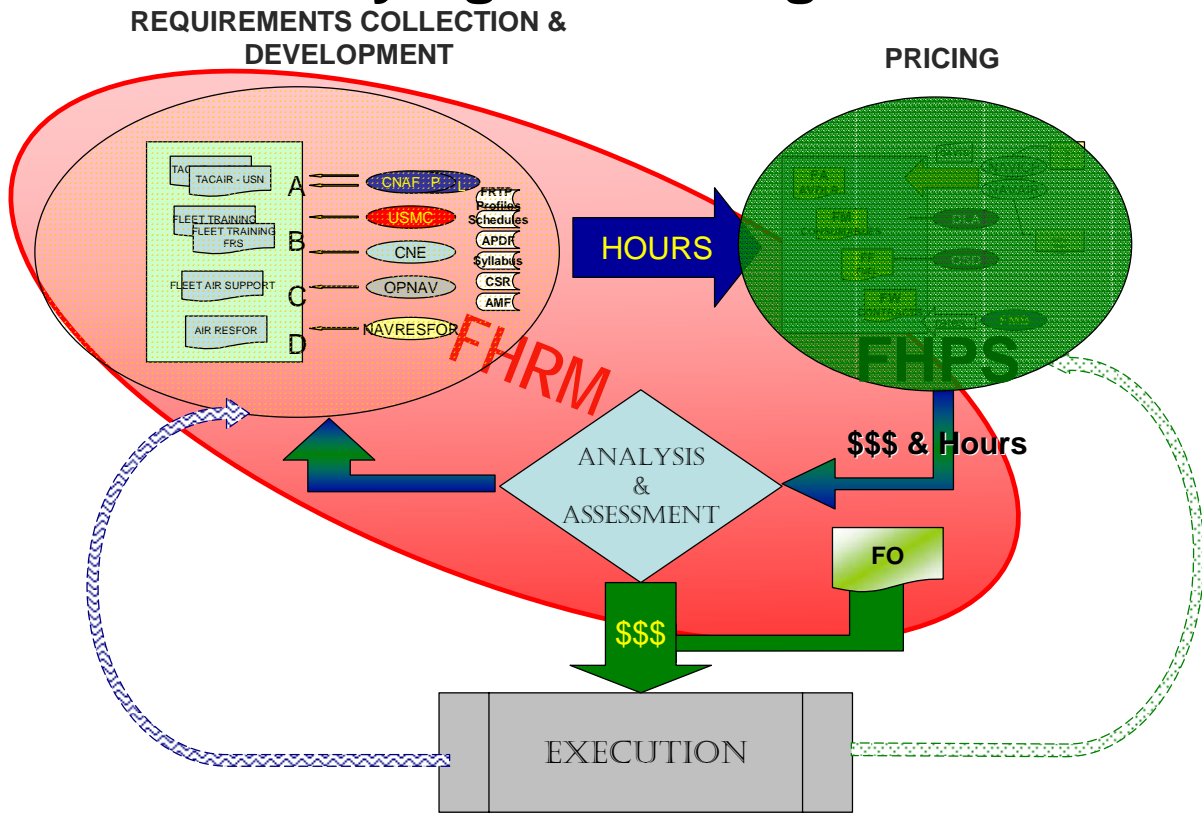

Figure 14. Flying Hour Resource Model

Source: General Dynamics, 2006, slide 5.

The FHRM is a web-based tool that develops annual flying hour requirements, assesses potential programming and budgeting decisions, and assesses both financial and operational impacts (General Dynamics, 2006, slide 3). Anteon Corporation (now General Dynamics) developed this model for users during the Requirements Collection and Development Phase and during the Analysis and Assessment Phase. It provides a user friendly and accurate means for FHP managers to input requirements for each T/M/S per schedule. These requirements are what N432D uses to combine with its pricing model of the FHPS to develop OP-20s. The second

function of the FHRM is the ability to conduct analysis of “what if” scenarios during the Analysis and Assessment Phase. Although N432D currently uses the FHPS as the model for “what if” drills, it plans to change to the FHRM because it is a less labor intensive model (N432D, 2006).

The CNAF FHP Manager manages the T&R Matrix and combines those requirements with readiness requirements from the Fleet Response Plan (FRP) into the FHRM. Interaction between CNAF FHP Manager and N432D is highest during budget formulation as CNAF justifies to N432D their requirements submission. The CNAF FHP Manager’s goal is to adequately convince N432D of the validity of CNAF requirements because N432D will later become the defender of these requirements to N80 and FMB. This process is usually smooth since N432D serves as the fleet advocate, but friction occurs periodically because of requirements exceeding N43’s top line budget for readiness. The CNAF FHP Manager’s stake is to preserve as many flying hours as possible while collaborating with N432D to meet the fiscal constraints.

***b. Marine Aviation***

The Deputy Commandant for Aviation is the HQMC Aviation Combat Element FHP advocate and is responsible for overall management of the USMC FHP. The section under the Deputy Commandant for Aviation that serves as the Marine Corps FHP Manager is Aviation Plans and Policy 2 (APP-2). APP-2 validates Marine Forces peacetime tactical aviation training requirements with the Training and Readiness Program (T&R), the Core Competency Requirement Model (CCRM) and Sortie Based Training Program (SBTP) submissions (U.S. Marine Corps, 2005, p. 2). It is responsible for balancing future requirements with current execution.

The T&R Program provides the syllabus for each T/M/S for core skills and proficiency levels. The model it uses that provides a direct link between readiness, requirements and resources is the CCRM. The CCRM directly links the T&R Program with the USMC FHP and Status of Resources and Training System (SORTS) readiness reporting program (U.S. Marine Corps, 2005, p. 3). The output of this model is the Marine Corps annual flying hour requirements by T/M/S per schedule to achieve its



prescribed readiness level. Although a separate model, the results are included into the FHRM as the total requirements submission to N432D.

The Sortie Based Training Program (SBTP) concept introduced by the Marine Aviation Campaign Plan differentiates Marine Corps Aviation training from Navy Aviation training. Whereas the Navy trains according to their T&R Matrix for individual pilots, the SBTP emphasizes each unit's core competencies over individual training goals. The intent of this execution tool is to allow squadron commanders to develop an executable sortie based training plan that reflects their unit's training exercise and employment plan to provide combat ready units for the Marine Air Ground Task Force (U.S. Marine Corps, 2005, p. 4). While the CCRM serves as a programming benchmark, the SBTP is what operations officers develop to tailor their squadrons' training requirements. APP-2 utilizes the CCRM and the totaled SBTP submission of the current year to generate the Marine Corps FHP requirement to N432D for the following fiscal year.

APP-2 interacts with N432D regularly to ensure that the Marine Corps receives its FHP funding requirements. During the budget formulation period, APP-2 and N432D often talk on a daily basis to reach consensus on important milestones. Throughout the remainder of the year, this interaction is usually one or two calls per week. The most important issues are when the Navy wants to reprogram or transfer funds from the FHP. The Marine Corps is willing to fair share the FHP cut as long as the unfunded requirement has utility for it (HQMC APP-2 FHP member, 2006). For example, if the funding goes to the construction of a submarine, the Marine Corps would be unwilling to agree to their share of the FHP reduction.

*c. OPNAV N80*

OPNAV N8 Integration of Capabilities and Resources is the Navy office that determines warfare requirements and allocates resources within the PPBES. As the Programming Section, N80 is responsible for prioritizing resources within the Navy in accordance with the CNO's goals (N801E Logistical Program Analyst, 2006). The FHP funding profile included in the N8 Sponsor Program Proposals (SPP) is just one of many that N80 receives from various Resource Sponsors during POM development. N80 requires the Resource Sponsors to state what they are funding and provide justifications

for the funding amount. It makes sure that the requirements within the SPPs match up with planning documents such as the JPG, the CNO Guidance, the Navy Strategic Plan, and the Global Naval Force Presence Policy. N80 balances the requirements of the SPPs with each other to present a unified Navy effort. If there is a disparity between programs, N80 makes recommendations to adjust funds from one program to the other to balance capabilities for the Navy. The functions of N80 can be characterized as an authorization process for Resource Sponsors.

N432D interaction with N80 is infrequent during the year except for the period leading up to building the POM. From February to June, N80 and N432D communicate two to three times a week so that N80 stays informed on issues during the FHP budget formulation (N801E Logistical Program Analyst, 2006). The role of N80 in FHP funding is to make sure that it matches up with the goals of the CNO. N432D must serve as the champion of the operating forces and justify why each schedule is funded at the level specified in the SPP.

*d. OPNAV N81*

OPNAV N81 does assessments and capabilities analysis for reductions during the PPBE process (N814D Aviation Readiness Analyst, 2006). N81 does a risk assessment on under-funding if the requirements exceed the top line budget and risk assessments for funding cuts recommended by N80. N81 analyzes the impact of lowered readiness levels and if the Navy and Marine Corps can accept them. These assessments are recommendations from the analysis of SPPs that N81 conducts for N8. The Deputy Chief of Naval Operations N8 then presents these assessments at the Three Star Board of Directors (BOD). Chapter IV discusses the BOD in greater detail. N81 advises if the risk is acceptable or if money should be moved from other programs. The role of N81 in the PPBE process can be characterized as the first step in the appropriation process. The final step in the appropriation process is when FMB moves funds from other programs in accordance with CNO orders.

Another role of N81 is conducting assessments for price and performance models for the OPNAV staff (N814D Aviation Readiness Analyst, 2006). Resource Sponsors submit models to N81 for verification and validation before it becomes accredited as an official Navy model for use in budgeting. The verification and

validation teams are led by N81 analysts and usually include members from FMB and the Resource Sponsor. Even established models need to be re-accredited every three years. This ensures that an unbiased evaluator assesses the functionality of the model before it is used in the PPBE process.

N81 interaction with N432D is occasional throughout the year until N4 submits its SPP. During the scrutiny of the SPP, N81 and N432D communicate a minimum of three times per week to discuss impacts of budget cuts (N814D Aviation Readiness Analyst, 2006). For the FHP funding, N81 serves as the independent assessor for the risks of under funding and if the lowered readiness levels are acceptable.

*e. FMB/OPNAV N82*

Fiscal Management Branch (FMB), also known as the Navy Budget Office, works for the Assistant Secretary of the Navy, Financial Management and Comptroller (ASN, FM&C). FMB is also N82 within the CNO chain of command depending on the function they perform during the various phases of the PPBE process. FMB coordinates with N80, N81, the Resource Sponsors and the major claimants to conduct the budgeting process. Since Programming and Budgeting are now concurrent in PPBES, FMB starts the budget analysis and adjusts later once N80 completes the POM. Like the OSD PPBE process during budgeting, FMB issues marks on budget submissions from major claimants that they dispute. These marks are appealed (in reclama) by either the major claimant or by the Resource Sponsor. Once this reclama process is complete, FMB submits the BES on behalf of the ASN, FM&C to the SECNAV for approval and forwarding to OSD.

During Execution, FMB assumes the functions of N82 and works for OPNAV N8 Integration of Capabilities and Resources. FMB is responsible for ensuring that the Major Claimants are executing their Appropriation allocations in accordance to fiscal law. During midyear reviews, N82 coordinates with major claimant comptrollers for issues involving the transfer or reprogramming of money. They also ensure that the major claimants are not under executing at the end of the fiscal year so that the Navy does not lose the money.

FMB/N82 is the agency that N432D interacts with the most due to the duties of N432D in pricing the flying cost per hour. The FMB FHP Analyst and Aviation

FHP Officers often phone each other two to three times a day to keep abreast of issues regarding FHP funding. These issues usually involve escalation rates, “what if” drills that adjust the budget, and generally providing mutual support to answer fiscal questions from within the DoN or OSD (FMB FHP Analyst, 2006). Like the relationship N432D has with the Fleet, FMB and N432D start the budgeting process as adversaries. N432D is trying to defend the Fleet requirements and FMB is looking at possible cuts. Once FMB accepts the Fleet requirements, it becomes the champion of it during the BES submission to OSD. As the duty experts on the FHP, N432D provides supporting data and insights to FMB while defending the BES submission. The stake FMB holds in the FHP budgeting process is to make sure that they have a defensible and executable budget that passes OSD scrutiny (FMB FHP Analyst, 2006).

#### **D. CHAPTER SUMMARY**

This chapter presented a detailed overview of the role and responsibilities of the N432D Aviation FHP Officer. The intent was to develop a profile of skills to help new Aviation FHP Officers in this challenging billet and to identify the specific tasks that need to be performed throughout the PPBE process. This chapter also identified key agents and agencies that are stakeholders in the FHP funding process and described their roles and responsibilities. It provided the frequency and the nature of interactions between these agencies and N432D during the year regarding FHP funding. The TYCOMs are primarily concerned with getting enough resources for their commands, N80 and N81 are focused on balancing the resources for the entire Navy, and FMB is concerned with acquiring and executing a funding level that is balanced for the entire DoN. This hierarchy of stakeholder interests is beneficial, as shown in analysis of FHP funding in Chapter IV.

THIS PAGE INTENTIONALLY LEFT BLANK

## **IV. OPNAV N432D ROLE IN FHP BUDGET FORMULATION**

### **A. INTRODUCTION**

A description of the primary tasks of N432D and an analysis of the FHP stakeholders were presented in Chapter III to provide the background necessary to understand their roles in budget formulation. This chapter analyzes the formulation of the FHP budget with an emphasis on how N432D guides the process.

As described in Chapter II, the main planning guidance during the planning phase is the Strategic Planning Guidance (SPG). The Joint Programming Guidance promulgates defense policy, strategy, force planning, resource planning, and fiscal guidance, which reflect economic constraints and SECDEF management priorities (American Society of Military Comptrollers, 2005, p. 1.2.18). The SECNAV uses the JPG to formulate his fiscal guidance issued through FMB to the Fleet. Concurrently, the CNO issues his yearly guidance stating his vision, priorities and objectives. This separation of budgeting as a civilian function and requirements being a military function is due to legislation enacted in the 1970s (McCaffery & Jones, 2004, p. 248). All OPNAV sections work to achieve the objectives of the CNO while following the fiscal guidance and procedures issued by FMB. During the planning phase, N432D relies heavily on the CNO guidance when identifying issues for the next budget formulation. Figure 15 shows the N432D budget formulation timeline that starts the budget cycle for the FHP.

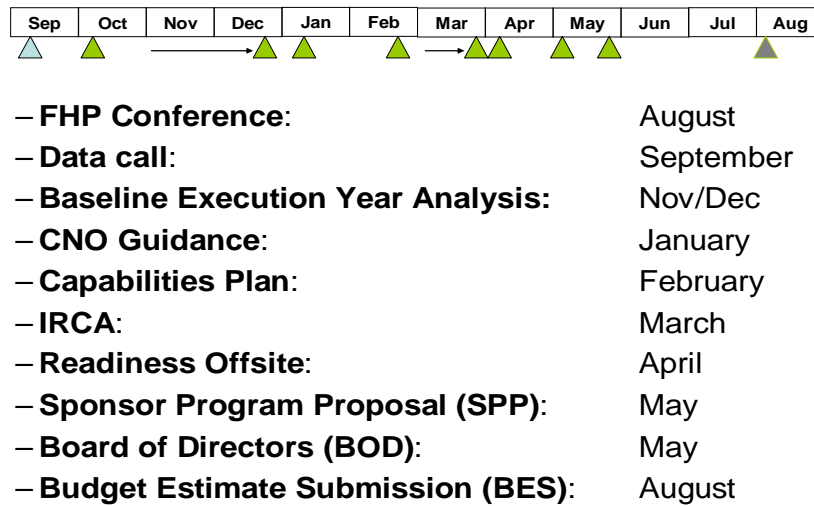

Figure 15. N432D Budget Formulation Timeline.

Source: OPNAV, 2006d, slide 12.

## B. FLYING HOUR PROGRAM CONFERENCE

During budget formulation, N432D starts each building of a new FHP budget by chairing an annual Flying Hour Program Conference. This conference gathers together all participants involved in formulating the FHP budget such as FHP managers, budgeters and analysts from the major claimants and supporting agencies. The purpose is to educate everyone on the workings and spending targets in the budget process, review what went well the previous year, and resolve potential problems for the upcoming year (N432D, 2006). The conference lasts usually two to three days and contains briefs from various key personnel in the FHP funding process. The conference starts with a summary of metrics from the previous year’s FHP budgeting and execution. The conference then moves on to outlining the budget formulation for the next year. These briefs are informal and participants are encouraged to raise topics for discussion. N432D acts as the arbitrator during these discussions, keeping the group focused on doing what is best for naval aviation.

At the conclusion of the conference, N432D restates the lessons learned from the previous year. The lessons that proved to be good are to be implemented as regular practice for the new budget year. N432D restates important problems that participants brought up during the conference and solutions that the group agreed upon. The goal is to get group consensus to speak as one voice to minimize the impact in coping with future budgetary problems and to assist in identifying and dealing with issues that reach beyond the authority of the participants and will need to be forwarded up the chain of command for decision. As the only opportunity per budget cycle for all participants to meet together, the conference is highly valuable for N432D to achieve a united effort in FHP administration and execution.

### **C. DATA CALL**

The first active step in budget formulation is in September when N432D sends the Data Call to all major claimants as well as supporting agencies. This document provides guidance for the submission of required FHP data input elements necessary to develop the fiscal resource requirements (OPNAV, 2006c, p. 1). The following table displays the data that claimants submit as requirements for the four schedules of TACAIR, FAT, FAS, and Reserve.



	Schedule A	Schedule B	Schedule C	Schedule D
<b>CNAF</b>	<ul style="list-style-type: none"> <li>•T&amp;R Matrix</li> <li>•Fleet Response Plan Profile</li> <li>•Equivalent Sortie Length (ESL)</li> <li>•Support Flight Hour Requirements</li> </ul>	•NSAWC Requirements	•Aircraft Utilization Rates	
<b>HQMC APP-2</b>	<ul style="list-style-type: none"> <li>•MACP</li> <li>•Crew Seat Ratio (CSR)</li> <li>•Aircrew Manning Factor (AMF)</li> <li>•Staff Requirements</li> </ul>			
<b>OPNAV N1</b>	<ul style="list-style-type: none"> <li>•CSR</li> <li>•AMF</li> <li>•Staff Requirements</li> </ul>			
<b>OPNAV N88 Air Warfare</b>	•APDF	<ul style="list-style-type: none"> <li>•Integrated Production Plan</li> <li>•FRS Syllabus</li> </ul>		
<b>CNAFR</b>				•Reserve Flight Hour Requirements

Table 3. Data Call Flying Hour Model Requirements

The principal agents that N432D coordinates with during this period are the CNAF FHP Manager, HQMC APP-2 FHP Manager, CNAFR FHP Manager and N882B (FRS requirements). N432D conducts extensive meetings or phone conversations with each of the claimants to go over every page of their requirements submission in either the FHRM or the CCRM. During this process, N432D checks submissions with historical OP-20s to see if there are any major deviations. If there are, N432D validates the requirements by questioning changes to force structure, Programs and Resources (P&R), or training requirements. These reviews are generally smooth since costs are not discussed and there is no pressure of a top line budget. At the end of this process is the informal agreement between N432D and the claimants for required flying hours.

#### **D. BASELINE EXECUTION YEAR ANALYSIS**

Concurrent with the requirement submissions, the Data Call also asks for pricing model data requirements. It is this certified cost data that N432D uses as the baseline for the budget formulation for fuel, Aviation Depot Level Repairables (AVDLR), and maintenance consumables. Contract maintenance does not use the baseline. NAVAIR

and the Fleets submit contract requirements as a separate input (NAVAIR FHP member, 2006). The BSOs submit the certified thirteenth month FHCR that removes all cost of war and one time expenses. This serves as the pricing baseline that projects a realistic program for peacetime operations. N432D loads and stores this data in the FHPS.

<b>BSOs</b>	•Certified FHCR
<b>FMB</b>	•Annual Price Change (Working Capital Fund Rates)
<b>Center of Naval Analysis (CNA)</b>	•Aging Aircraft Adjustment
<b>NAVAIR NAVICP CNAL CNAP</b>	•Cost Adjustment and Visibility Tracking System (CAVTS)

Table 4. Data Call Pricing Model Requirements

Numerous factors adjust the baseline figure provided by the FHCR such as annual price changes, aging aircraft adjustments and inputs from the Cost Adjustment and Visibility Tracking System (CAVTS). FMB provides approved barrel prices to determine future fuel requirements and Working Capital Fund (WCF) rate adjustments for AVDLRs and consumables. The CNA provides the Aging Aircraft Adjustment that is used to adjust the AVDLR CPH based on the age of the aircraft. The final item is CAVTS.

The CAVTS process allows program teams to provide the CNO with budget issues that will either positively or negatively impact future AVDLR or maintenance

consumables costs. For example, the Program Manager of F-18s installs retrofit kits that reduce cost for AVDLRs. This CAVTS submission results in a positive adjustment for AVDLR costs (OPNAV, 2006b, p. 7). The NAVAIR FHP Team manages the Cost Adjustment Sheets (CAS), the spreadsheet format for CAVTS submissions. CAVTS and CAS also capture all new requirements that will shift from Aircraft Procurement, Navy (APN) to OMN. For example, expiration of a warranty on a new aircraft or part now needs to be maintained by OMN funds (N432D, 2006). During the Baseline Execution Year Analysis, N432D and NAVAIR phone each other frequently to discuss CAS inputs. Ultimately, it is N432D's decision on which CAS inputs they accept for inclusion into the FHPS.

#### **E. CAPABILITIES PLAN**

The Capabilities Plan (CP) combines the information gathered in the Data Call with the information captured in the execution year analysis along with the N43 top line budget for aviation readiness. N432D inputs all flying hour requirements into the FHPS submitted by CNAF, the Marine Corps, CNAFR, and N88. N432D takes the latest CPH by T/M/S generated by the Baseline Execution Year Analysis and multiplies it by the requirements to produce a CP OP-20. N432D uses the data from this budget exhibit to draft the Capabilities Plan. The CP provides tables by Service and by schedule showing the difference between the budget estimate requirements and budget controls. The controls are the top line budget amount established by N43 for the different readiness programs. The overall budget ceiling for the Navy is set by FMB, but each Resource Sponsor prioritizes its individual program ceiling based on the CNO guidance (FMB FHP Analyst, 2006). The tables in the CP are summed in a final table representing either the total deficit or the total surplus.

The purpose of the CP is to serve as an official report of the budgeting profile of the FHP without any adjustments to either flying hours or the CPH. It also presents issues that need to be addressed to improve, refine or mitigate the FHP requirements. These issues change year by year and are decisions that dramatically affect costs in one or more of the Special Interest Codes. N432D sends this report to all stakeholders of the

FHP in OPNAV and the operating forces. The results of the CP lead to the Integrated Readiness Capabilities Assessment (IRCA), the next step in the budget formulation process.

#### **F. INTEGRATED READINESS CAPABILITIES ASSESSMENT**

The IRCA process is a collaborative effort between OPNAV offices and the operating forces on what to fund and what not to fund. The IRCA starts with an internal N4 cost mitigation to reduce the required costs closer to the top-line budget figure. N4 directs N432D to reduce the funding shortfall before sending it to the operating forces for their cuts. To achieve this reduction, N432D has the authority to cap FO costs. N432D also targets requirements that have redundancy. For example, the Navy's transition to the MH-60 helicopter from the HH-60. N432D could cut the Navy request for additional flying hours here because they are similar aircraft performing the same mission (N432D, 2006). N432D also has the authority to cap total flying hours if they deem that the requirements were not valid. N432D uses these methods to lower the shortfall as long as it does not affect capabilities. Once N432D gets to the threshold where they think they could be affecting capabilities, it is time to involve the claimants in the IRCA process.

The three main claimants involved in the IRCA process are CNAF, HQMC APP-2 and CNAFR. N432D presents them with the remaining shortfall and it is up to these claimants to prioritize what to cut. The FHP managers can further mitigate down the shortfall by reducing maintenance contracts and further caps to FO costs. However, this can be a contentious process because hours are easier to reduce than costs and the claimant FHP managers vigorously defend the hours. Decisions that affect capabilities are beyond the level of N432D and the claimant FHP managers, and must be addressed by their respective flag officers. N432D is the central organization providing the "what if" drills representing different combinations of cuts to flying hours or indirect support costs. These drills present alternative impacts of cutting funds from specific T/M/S or from the different special interest codes. It is important to note that the results presented in the CP change with time. Since IRCA can last from February to April, N432D continues to receive new data such as updated inflation rates, fuel prices, and CAS adjustments that must be processed by the FHPS for current CPH figures for these drills.

An organization that is central during this portion of the IRCA deliberation is the Naval Aviation Enterprise (NAE) and its Board of Directors (BOD).

<b>Board of Directors (BOD)</b>	
*Commander Naval Air Forces(CNAF), CEO	US Marine Corps Aviation (USMC AVN)
*Commander Naval Air Systems Command (NAVAIR), COO	Naval Strike Air Warfare Center (NSAWC)
*Commander Naval Air Forces Atlantic (CNAL)	Naval Supply Systems Command (NAVSUP)
*Chief Financial Officer (NAVAIR)	Operational Test & Evaluation Force (OPTEVFOR)
*Total Force Readiness Officer (NAVAIR)	Commander US Fleet Forces Command (CFFC N4/7)
OPNAV N43	Chief of Naval Air Training (CNATRA)
OPNAV N82	Commander Naval Air Forces Reserve (CNAFR)
*OPNAV N88	Deputy Assistant Secretary of the Navy, Air
Deputy Assistant Secretary of the Navy, Logistics	
Naval Education & Training Command (NETC)	Naval Sea Systems Command (NAVSEA)
Navy Military Personnel Command (NMPC)	Space & Naval Warfare Systems Command (SPAWAR)
Naval Network Warfare Command (NETWARCOM)	Commander Naval Installations (CNI)

\* NAE BOD Executive Committee (6 Members)

Table 5. NAE Board of Directors

Source: Naval Aviation Enterprise Website, <http://www.cnaf.navy.mil/nae/main.asp?ItemID=13>. 2006.

The NAE is a warfighting partnership in which interdependent issues affecting multiple commands are resolved on an enterprise-wide basis (Naval Aviation Enterprise Website, 2006). The NAE is comprised of a Board of Directors (BOD) representing all stakeholders in the FHP funding process. One of the primary goals of the NAE is to balance current and future readiness. The commanders of the organizations represented

in the NAE BOD frequently are the requestor of the N432D “what if” drills for them to determine their optimal position on readiness versus acceptable risk. From these drills, the NAE decides on further reductions in hours, contracts, maintenance, or indirect costs that are acceptable. This process that adjusts readiness is known as the Readiness Offsite.

#### **G. SPONSOR PROGRAM PROPOSAL**

By May, N432D finalizes the FHP portion of the N4 SPP with information gathered during the IRCA and Readiness Offsite. It shares this information with N80 and FMB who need to start making their assessments for the POM and the BES respectively. The SPP presents what cuts N4 made, with input from the claimants, to try to get down to the monetary constraints. The remaining difference is presented to the Three Star Board of Directors (BOD) in the form of different courses of action. These represent tradeoffs in capabilities and readiness levels for the different T/M/S or between the Navy and the Marine Corps. The BOD is comprised of the Deputy Chief of Naval Operations of each OPNAV section. The BOD convenes to assess the impacts of cuts and tradeoffs between programs necessary to achieve the right mix of readiness for the DoN within the constrained resources. N80 and N81’s initial assessments of the FHP are presented by N8. The BOD recommendations are present to the CNO for approval or revision. Once the CNO makes his decision on his acceptable readiness levels and risks, these are the final requirements are sent to FMB for the development of the BES.

The active role of N432D in formulating the FHP budget is over after the BOD and it passes the SPP to N80. During the programming and budgeting phases, N432D is often called upon by N80, N81 and FMB to answer questions during the development of the POM and the BES. Even as the BES becomes part of the President’s Budget, N432D via the FMB and OSD may be called upon to provide supporting information during the congressional review. Finally during the budget execution, N432D reviews the monthly FHCR submissions by the BSOs to start collecting historical data and identify potential issues. These issues typically involve investigating variances in budgeted costs and execution costs to determine if the original data was valid (N432D, 2006). The

completion of the execution phase completes the budgeting cycle as N432D prepares to use the validated historical figures as the baseline for the next budget formulation.

## **H. CHAPTER SUMMARY**

This chapter analyzed the role of the N432D Aviation FHP Officer during budget formulation. This period covers ten months from August to May and is the beginning of each budget cycle. The purpose of this chapter is to tie in the tasks and responsibilities of N432D and the FHP stakeholders during the various steps that make up the budget formulation. It chronicled the contributions of N432D in shaping the budget through the major milestones of formulation process. N432D guides the budget formulation with the FHP Conference to pass OPNAV guidance and work out issues with the stakeholders. As the manager of the FHPS, N432D is the central organization that provides the OP-20s needed by the claimants to build their budgets. Throughout the building of the budget, N432D validates all costs and requirements from the operating forces so that it can effectively represent the needs of the operating forces when it submits the SPP to N80 and FMB. The efforts of N432D in producing a well balanced SPP and the support it provides to N80 and FMB greatly contribute to the development of the FHP input to the POM and the BES. As the cycle completes the loop, N432D gathers the feedback information during the execution phase to begin planning for the next cycle.

## V. CONCLUSION

### A. INTRODUCTION

The purpose of this project is to examine the role and responsibilities of the Aviation FHP Officer and to provide a ready reference to better prepare future members of N432D. Chapter II presented an overview of the PPBES and the Navy FHP to provide the proper background for readers to understand the dynamic arena in which the Aviation FHP Officer operates. Chapter III examined what skills are beneficial for N432D and the roles and responsibilities of the Aviation FHP Officer, including interacting with key stakeholders. Chapter IV examined the Aviation FHP Officer's role during the PPBE process and how N432D guides budget formulation. This chapter provides the answers to the primary and secondary research questions, presents a conclusion, and suggests topics for further research.

### B. PRIMARY RESEARCH QUESTION

**What is N432D Aviation Flying Hour Program Officer's role and impact in the budget formulation process for the Navy Flying Hour Program?**

During the budget formulation, N432D is the central agent in collecting all FHP requirements and developing the CPH. N432D validates all requirements and cost adjustment inputs to ensure an accurate forecast of funding requirements. Inevitably, the total cost of the requirements will exceed the controls imposed by OSD through FMB. N432D then becomes the central provider of results of "what if" drills that help flag level boards decide on acceptable tradeoffs when adjusting the FHP funding request down to the control level. The end result is the development of a balanced SPP that OPNAV N4 presents at the Three Star BOD where the members prioritize readiness and determine acceptable risk levels for shortfalls. The role of N432D as the resident expert on the FHP makes it the unit that all FHP stakeholders consult before making a decision on adjusting FHP funding.



## **C. SECONDARY RESEARCH QUESTIONS**

### **1. What are the responsibilities and primary tasks of the N432D Aviation Flying Hour Program Officer?**

OPNAV N4 designates N432D as the duty expert on the FHP to serve as the focal point for developing FHP funding requirements. Therefore, the official tasks of N432D are to maintain the FHPS, generate the OP-20 backup exhibits, represent the claimants' FHP issues and review current year execution. Unofficially, the tasks of N432D include managing the stakeholders in the FHP funding process to maintain open communication and honest exchange of information. This development of strong and trusting relationships with the claimants and supporting agencies has a critical impact on how the FHP is developed, resourced and defended.

### **2. What key knowledge areas, skills and abilities are important to N432D Aviation FHP Officers?**

Although there are no official prerequisites for becoming a new Aviation FHP Officer, this project lists aviation background and MBA education as being highly beneficial. The aviation background gives the Aviation FHP Officer instant familiarity with the needs of the Air TYCOM FHP managers. This commonality in background and language may facilitate a stronger working relationship with the claimants. When N432D needs to defend the requirements to N80 and FMB, the aviation background gives the Aviation FHP Officer more credibility when giving expert information on the needs of the aviation forces.

Due to the fiscal nature of the duties of the Aviation FHP Officer, an MBA from NPS in Financial Management provides pertinent tools for success. These skills include a good foundation in the basics of federal budgeting, the PPBE process, and a working knowledge of defense acquisition. Skills gained in courses in modeling and cost estimation also will contribute greatly in the actual performance of essential tasks. Additionally, the MBA credential helps to give the Aviation FHP Officer more credibility when interacting with civilian career comptrollers and budgeters.

**3. How does N432D manage stakeholders to minimize potential friction points? What type and amount of formal and informal communication is necessary between N432D and stakeholders to prepare a balanced budget and FHP plan?**

An important element of the duties of the Aviation FHP Officer is building and maintaining solid relationships with the claimants and supporting agencies. N432D does this by hosting the annual FHP Conference prior to the start of each budget formulation. This meeting allows all stakeholders to meet and discuss issues with N432D during the briefings and during sidebar sessions. Besides reviewing FHP budget execution of the previous year, N432D uses the conference to get all operating forces FHP managers and other FHP action officers to speak as a common voice on remaining FHP issues and concerns.

Besides the FHP Conference, N432D maintains open and frequent communications with all agencies involved in building the FHP budget. The majority of the communications with fellow FHP action officers is informal, either phone calls or emails. The trend for this communication tends to be heaviest during the budget formulation period from September to May. However, some agencies including FMB/N82 require daily interaction throughout the year. N432D also conducts formal briefings on an as needed basis. These briefings are heaviest during the IRCA process from February through April and are usually related to “what if” drills requested by flag level officers. Overall, the success of N432D in presenting a well balanced FHP SPP to N80 and FMB depends on the ability to foster and maintain strong communications within the FHP budgeting community.

**D. CONCLUSIONS**

Although the DoD is currently utilizing a biennial budget process, N432D and the FHP stakeholders start a new budget formulation each year, whether it is a POM year or a PCP year. Even during the current GWOT, there are still fiscal constraints that the Navy and Marine Corps must consider when budgeting flying hour requirements. Therefore, a well balanced budget proposal developed during budget formulation is very important to ensure that FHP funding requirements are built into the Navy POM/PCP and BES/BCP.

Since the N432D Aviation FHP Officers play a vital role in the formulation of the FHP budget, it is essential that these officers be versatile and well trained in their duties. This project identifies and explains key knowledge areas and skills that are highly desirable and necessary for new Aviation FHP Officers to have to hasten their proficiency in performing effectively in this billet. As important, Aviation FHP Officers need to possess good interpersonal skills due to their heavy interaction with the FHP stakeholders. It is this skill that allows the Aviation FHP Officers to work through the numerous issues and challenges that emerge during every budget formulation cycle. Although it is only one of many units within the Navy organization that contribute to building the FHP budget, the role of N432D as the Navy resident expert on the FHP greatly facilitates the process in achieving a strong balance between the needs of the operating forces and the fiscal constraints that are always present in the budget process.

## **E. SUGGESTIONS FOR FURTHER RESEARCH**

### **1. Impact of CNAF assuming operational control of CNATRA?**

Currently, there is a realignment process underway for the Naval Education and Training Command (NETC) to detach CNATRA for CNAF to assume operational control in October 2006. The BSO will shift from NETC to PACFLT in October 2007. The current decision is for N1 to remain as the Resource Sponsor for CNATRA providing funds for entry flight training. A question for further research is: should the Resource Sponsor shift from N1 to N4?

### **2. Naval Aviation Enterprise**

The Naval Enterprise concept is the Navy's vehicle to better utilize the finite amount of force structure, readiness and capabilities resident in our operating forces by more deliberately introducing better business practices and discipline in our stewardship of manpower and resources and in measuring the effects of these inputs on our warfighting output (National Navy Officer's Association, 2005). Currently, the Navy has multiple organizations involved in developing and managing FHP requirements and budgeting including the OPNAV sections, CNAF, and Fleet Forces Command. A second

research question is: as the NAE matures, should management of the FHP consolidate for more efficiency and, if so, how should consolidation be accomplished?

THIS PAGE INTENTIONALLY LEFT BLANK

## LIST OF REFERENCES

- American Society of Military Comptrollers, (2005, January). *Enhanced Defense Financial Management Training Course*.
- Candrea, P.J., (2004). *Practical Financial Management: A Handbook for the Defense Department Financial Manager*. 6th ed. Naval Postgraduate School, Monterey, CA.
- Commander Naval Air Forces, (2006). *Naval Aviation Vision 2020*.
- Commander Naval Air Forces Webpage, History. Retrieved October 6, 2006, from <http://www.cnaf.navy.mil/main.asp?ItemID=148>.
- Crenshaw, (2006). Brief: Navy PPBE and a Programmatic and Budget View of POM08. July.
- Defense Acquisition University, *Defense Acquisition Guidebook*. Retrieved August 24, 2006, from [http://www.deskbook.osd.mil/dag/GuideBook/IG c1.2.asp](http://www.deskbook.osd.mil/dag/GuideBook/IG%20c1.2.asp).
- Department of the Navy (2006). *DON-OP-20 Analysis of Navy Flying Budget Backup Exhibit, Resource Sponsor N43 Report 7310-A8505-20*. Washington, DC: Department of the Navy. September 21.
- Department of the Navy Acquisition One Source Webpage, Logistics Engineering Change Proposal. Retrieved October 6, 2006, from <http://acquisition.navy.mil/navyaos/content/view/full/150>.
- Department of the Navy Financial Management and Comptroller Webpage, Retrieved August 10, 2006, from [http://www.finance.hq.navy.mil/fmb/6pres/ops/OMNR Book.pdf](http://www.finance.hq.navy.mil/fmb/6pres/ops/OMNRBook.pdf).
- EDO Corporation, (2004). Flying Hour Other (FO) Brief. July 21.
- General Dynamics, (2006). Flying Hour Requirements Model Brief. July 27.
- Keating, P.J. & Paulk, D.A., (1998). *Examination of the Flying Hour Program (FHP) Budgeting Process and an Analysis of Commander Naval Air Forces Pacific (CNAP) FHP Underfunding*. Master's Thesis, Naval Postgraduate School, Monterey, CA. December.
- Matthews, Dave, (2006). MN3331 Class Slide Presentation: Defense Resource Allocation. June.

- McCaffery, J.L. & Jones, L.R., (2004). *Budgeting and Financial Management for National Defense*. Greenwich, CT: Information Age Publishing Inc.
- OSD Comptroller iCenter. The Budget Process. Retrieved August 20, 2006, from <http://www.dod.mil/comptroller/icenter/budget/histcontext.htm>.
- National Naval Officer's Association (2005). Naval Enterprise Framework. Retrieved November 3, 2006, from [http://www.nnoa.org/display\\_bulletins.php?id=152](http://www.nnoa.org/display_bulletins.php?id=152).
- Naval Air Systems Command Webpage, Cost Adjustment Visibility Tracking System. Retrieved October 6, 2006, from <http://logistics.navair.navy.mil/cavts/index.cfm>.
- Naval Aviation Enterprise Website, About the NAE. Retrieved October 23, 2006, from <http://www.cnaf.navy.mil/nae/main.asp?ItemID=13>.
- Office of Management and Budget, (2005). *Historical Tables: Budget of the United States Government, Fiscal Year 2005*, Retrieved November 18, 2006, from <http://www.whitehouse.gov/omb/budget/fy2005/pdf/hist.pdf>.
- OPNAV (1996). *N88 Special Assistant for the Flying Hour Program (FHP) Desktop Procedures Guide (Draft)*. Washington, DC: Department of the Navy.
- OPNAV (2004). *N432D Flying Hour Program Model Accreditation Report*. Washington, DC: Department of the Navy. April 30.
- OPNAV, (2005). *N43 Fleet Readiness Division Memorandum: Program Review (PR-07) Flying Hours Program Capabilities Plan*. Washington, DC: Department of the Navy. January 28.
- OPNAV (2006a). *N432D Flying Hour Projection System Brief*. May.
- OPNAV (2006b). *N432D PR-09 FHP Meeting POM-08 Review*. Washington, DC: Department of the Navy. July 26.
- OPNAV (2006c). *N43, Data Call in Support of the Flying Hour Program Capabilities Plan Development for PR-09*. Washington, DC: Department of the Navy. September.
- OPNAV (2006d). *N432D Brief: Flying Hour Program Conference*. September 20.
- Personal interview with Flying Hour Program member, Commander Naval Air Forces Atlantic, Alexandria, VA, July 27, 2006.
- Personal Interview with N432D Flying Hour Program Officer, OPNAV N43 Fleet Readiness Division, Alexandria, VA, July 27, 2006.

Telephone interview with Aviation Readiness Analyst, OPNAV N814D, Washington, DC, August 25, 2006.

Telephone interview with Flying Hour Program Analyst, OPNAV N82 Fiscal Management, Washington, DC, October 11, 2006.

Telephone interview with Flying Hour Program member, Commander Naval Air Forces, San Diego, CA, October 6, 2006.

Telephone interview with Flying Hour Program member, Headquarters Marine Corps APP-2, Washington, DC, October 6, 2006.

Telephone interview with Flying Hour Program member, Naval Air Systems Command, Patuxent River, MD, August 23, 2006.

Telephone interview with Logistical Program Analyst, OPNAV N801E, Washington DC, October 5, 2006.

Telephone interview with N432D Flying Hour Program Officer, OPNAV N43 Fleet Readiness Division, Washington, DC, August 16, 2006.

Telephone interview with N432D Flying Hour Program Officer, OPNAV N43 Fleet Readiness Division, Washington, DC, September 20, 2006.

Telephone interview with N432D Flying Hour Program Officer, OPNAV N43 Fleet Readiness Division, Washington, DC, November 2-3, 2006.

U.S. Marine Corps, (2005). *Marine Corps Order 3125.1A: Marine Corps Flying Hour Program (FHP) Management*. Washington, DC: Department of the Navy. April 4.

U.S. Navy Webpage, OPNAV Organization. Retrieved August 20, 2006, from <http://www.navy.mil/navydata/organization/org-cno.asp>.



THIS PAGE INTENTIONALLY LEFT BLANK

## INITIAL DISTRIBUTION LIST

1. Defense Technical Information Center  
Ft. Belvoir, Virginia
2. Dudley Knox Library  
Naval Postgraduate School  
Monterey, California
3. Professor Lawrence R. Jones  
Naval Postgraduate School  
Graduate School of Business and Public Policy  
Monterey, California
4. Professor Jerry L. McCaffery  
Naval Postgraduate School  
Graduate School of Business and Public Policy  
Monterey, California
5. Clinton J. Miles  
Office of the Comptroller  
Commander Naval Air Forces Pacific (CNAP)  
NAS North Island, California
6. David K. Jarvis  
Woodbridge, Virginia