



Calhoun: The NPS Institutional Archive
DSpace Repository

Theses and Dissertations

1. Thesis and Dissertation Collection, all items

2001-09

Response surface methods applied to submarine concept exploration

Goggins, David A.

Monterey California. Naval Postgraduate School

<https://hdl.handle.net/10945/10921>

This publication is a work of the U.S. Government as defined in Title 17, United States Code, Section 101. Copyright protection is not available for this work in the United States.

Downloaded from NPS Archive: Calhoun



Calhoun is the Naval Postgraduate School's public access digital repository for research materials and institutional publications created by the NPS community. Calhoun is named for Professor of Mathematics Guy K. Calhoun, NPS's first appointed -- and published -- scholarly author.

Dudley Knox Library / Naval Postgraduate School
411 Dyer Road / 1 University Circle
Monterey, California USA 93943

<http://www.nps.edu/library>

NORTH ATLANTIC TREATY ORGANIZATION



RESEARCH AND TECHNOLOGY ORGANIZATION

BP 25, 7 RUE ANCELLE, F-92201 NEUILLY-SUR-SEINE CEDEX, FRANCE

RTO TECHNICAL REPORT 15

Human Consequences of Agile Aircraft

(Facteurs humains liés au pilotage des avions de combat très manoeuvrants)

This report was sponsored by the Human Factors and Medicine Panel (HFM).

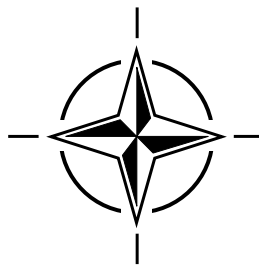

Published May 2001

Distribution and Availability on Back Cover

Form SF298 Citation Data

Report Date <i>("DD MON YYYY")</i> 00052001	Report Type N/A	Dates Covered (from... to) <i>("DD MON YYYY")</i>
Title and Subtitle Human Consequences of Agile Aircraft		Contract or Grant Number
		Program Element Number
Authors		Project Number
		Task Number
		Work Unit Number
Performing Organization Name(s) and Address(es) Research and Technology Organization North Atlantic Treaty Organization BP 25, 7 rue Ancelle, F-92201 Neuilly-sur-Seine Cedex, France		Performing Organization Number(s)
Sponsoring/Monitoring Agency Name(s) and Address(es)		Monitoring Agency Acronym
		Monitoring Agency Report Number(s)
Distribution/Availability Statement Approved for public release, distribution unlimited		
Supplementary Notes		
Abstract		
Subject Terms		
Document Classification unclassified	Classification of SF298 unclassified	
Classification of Abstract unclassified	Limitation of Abstract unlimited	
Number of Pages 186		

This page has been deliberately left blank



Page intentionnellement blanche

NORTH ATLANTIC TREATY ORGANIZATION



RESEARCH AND TECHNOLOGY ORGANIZATION

BP 25, 7 RUE ANCELLE, F-92201 NEUILLY-SUR-SEINE CEDEX, FRANCE

RTO TECHNICAL REPORT 15

Human Consequences of Agile Aircraft

(Facteurs humains liés au pilotage des avions de combat très manoeuvrants)

Authors:

T.J. LYONS (US) (Working Group Chairman)

Co-Authors:

W. ALBERY (US), R.D. BANKS, W. BLES (NE), G. CALHOUN (US),
J.-M. CLERE (FR), J.-L. FIRTH (UK), J.-Y. GRAU (FR), F. KNOX (US),
P. LE BLAYE (FR), J. LINDER (SW), J. PLAGA (US), V. PONOMARENKO (RUS),
V. SANTI (US), L. SPECKER (US), M. STUCKY (US), W.C.M. TIELEMANS (NE),
H. WELSCH (GE)

This report was sponsored by the Human Factors and Medicine Panel (HFM).



The Research and Technology Organization (RTO) of NATO

RTO is the single focus in NATO for Defence Research and Technology activities. Its mission is to conduct and promote cooperative research and information exchange. The objective is to support the development and effective use of national defence research and technology and to meet the military needs of the Alliance, to maintain a technological lead, and to provide advice to NATO and national decision makers. The RTO performs its mission with the support of an extensive network of national experts. It also ensures effective coordination with other NATO bodies involved in R&T activities.

RTO reports both to the Military Committee of NATO and to the Conference of National Armament Directors. It comprises a Research and Technology Board (RTB) as the highest level of national representation and the Research and Technology Agency (RTA), a dedicated staff with its headquarters in Neuilly, near Paris, France. In order to facilitate contacts with the military users and other NATO activities, a small part of the RTA staff is located in NATO Headquarters in Brussels. The Brussels staff also coordinates RTO's cooperation with nations in Middle and Eastern Europe, to which RTO attaches particular importance especially as working together in the field of research is one of the more promising areas of initial cooperation.

The total spectrum of R&T activities is covered by the following 7 bodies:

- AVT Applied Vehicle Technology Panel
- HFM Human Factors and Medicine Panel
- IST Information Systems Technology Panel
- NMSG NATO Modelling and Simulation Group
- SAS Studies, Analysis and Simulation Panel
- SCI Systems Concepts and Integration Panel
- SET Sensors and Electronics Technology Panel

These bodies are made up of national representatives as well as generally recognised 'world class' scientists. They also provide a communication link to military users and other NATO bodies. RTO's scientific and technological work is carried out by Technical Teams, created for specific activities and with a specific duration. Such Technical Teams can organise workshops, symposia, field trials, lecture series and training courses. An important function of these Technical Teams is to ensure the continuity of the expert networks.

RTO builds upon earlier cooperation in defence research and technology as set-up under the Advisory Group for Aerospace Research and Development (AGARD) and the Defence Research Group (DRG). AGARD and the DRG share common roots in that they were both established at the initiative of Dr Theodore von Kármán, a leading aerospace scientist, who early on recognised the importance of scientific support for the Allied Armed Forces. RTO is capitalising on these common roots in order to provide the Alliance and the NATO nations with a strong scientific and technological basis that will guarantee a solid base for the future.

The content of this publication has been reproduced directly from material supplied by RTO or the authors.

Published May 2001

Copyright © RTO/NATO 2001
All Rights Reserved

ISBN 92-837-1065-7



*Printed by St. Joseph Ottawa/Hull
(A St. Joseph Corporation Company)
45 Sacré-Cœur Blvd., Hull (Québec), Canada J8X 1C6*

Human Consequences of Agile Aircraft

(RTO TR-015 / HFM-015)

Executive Summary

While historically the issue of agile flight was first seen as an issue of airframe agility with a consequent emphasis on acceleration issues, there has been an evolution in the understanding of agility. WG 27, formed to study the human factors implications of agile aircraft, adopted the recommendations from WG 19, that aircraft agility is only one aspect of agility which when combined with weapons agility and systems agility results in “operational agility.” The experienced pilots that we interviewed saw a real operational need for agile aircraft. They consistently rated both high angle-of-attack/nose pointing and off-boresight missiles/helmet-mounted display/sight systems as very important capabilities. They denied physiologic problems related to acceleration or spatial disorientation, although their sorties to date have been with a clear sky, in active control.

But there are significant human factors issues to be addressed in response to increases in airframe agility for future fighter aircraft. These aircraft could be thrust vectored and capable of high AOA maneuvering. Current generation fighters may be retrofitted to achieve the same capabilities. G-LOC and spatial disorientation mishaps that continue to occur even in non-agile aircraft, will be an even greater risk as airframe agility increases. Potential neuromuscular consequences of flight involving changing accelerations include bio-mechanical feed-through with consequent difficulties in aircraft control. Little work has been done on the effects on psychomotor and cognitive activities at acceleration rates under loss of consciousness thresholds. Significant design issues include seat position relative to the center of gravity of the aircraft; this can impact the accelerations experienced by the pilot unless the flight control system is designed to control aircraft movement around the cockpit, rather than around the CG. Having the pilot as a passive occupant (for example, during automatic guns aiming, automated missile avoidance, etc.) can increase the pilot’s disorientation and airsickness. Designers should carefully consider the potential problems introduced by adding a second seat in agile aircraft.

With minimal constraints on angle-of-attack and expanded weapon launch envelopes, novel displays will be required that enable pilots to fly with references well beyond conventional fields-of-view. Current displays are not optimally designed to simultaneously display both nose position and velocity vector; energy state cannot be adequately displayed. Pilots of agile aircraft will desire helmet mounted displays but with minimal clutter. Experienced pilots are quite comfortable with current HOTAS systems. But pilots are unanimous in advocating a simple platform to fly; an integrated flight control system (“carefree manoeuvring”) is essential in future agile aircraft.

Increased physiological and psychological demands on the pilot combined with faster information flow and increased task dimensionality make a strong argument for some type of electronic crewmember. Enhancing the synergy between pilot and vehicle, including the development of intelligent interfaces including tailored displays/controls, adaptive interfaces (including pilot monitoring systems), and the right degree of automation should be expected to enhance pilot performance and facilitate the realization of the full potential of agile aircraft. Research is needed both on cognitive performance and team performance issues, the interaction between cognitive performance and physiologic stresses, and on selection and training strategies. Current pilot-protection systems will be inadequate to restrain pilots in an unconstrained flight envelope and during ejection. As current simulation of the agile flight environment is inadequate, new simulation capabilities and in flight research will be required. Both basic and applied research will be needed to ensure that the potential benefits of increased agility are realized.

Facteurs humains liés au pilotage des avions de combat très manoeuvrants

(RTO TR-015 / HFM-015)

Synthèse

Bien qu'à l'origine, la question de manoeuvrabilité ait été considérée uniquement du point de vue de la souplesse de la cellule, et que, par conséquent, une attention particulière ait été accordée aux problèmes d'accélération, aujourd'hui, nos connaissances en matière de manoeuvrabilité ont considérablement évolué. Le groupe de travail WG 27, créé pour étudier les facteurs humains liés au pilotage des avions de combat très manoeuvrants a adopté les recommandations du WG 19, à savoir que la manoeuvrabilité des aéronefs n'est qu'un aspect de la manoeuvrabilité, qui doit être combiné avec la manoeuvrabilité des armes et la manoeuvrabilité des systèmes pour constituer « la manoeuvrabilité opérationnelle ». Interrogés sur la manoeuvrabilité, des pilotes militaires expérimentés en ont confirmé la nécessité opérationnelle. Ils ont systématiquement accordé une grande importance aux caractéristiques d'angles d'incidence élevés/pointage du nez et de missiles dépointés/viseurs de casque. Pour eux, rien ne laisse présager que les accélérations et la désorientation spatiale puissent entraîner des problèmes physiologiques majeurs. Il faut noter, cependant, que la plupart des missions avec des taux élevés de manoeuvrabilité sont effectuées en ciel clair, le pilote disposant de tous les repères visuels habituels.

Pourtant il y a des questions importantes liées aux facteurs humains qui doivent être examinées afin de pouvoir répondre à la demande d'une meilleure manoeuvrabilité pour les futurs avions de combat. Ces avions disposeront d'une poussée orientable et seront capables d'effectuer des manoeuvres aux grands angles d'attaque. Les avions de combat actuels pourraient être rééquipés de tuyères d'orientation de la poussée pour atteindre les mêmes capacités. Au fur et à mesure de l'assouplissement des cellules, les risques d'incidents liés à la perte de connaissance et à la désorientation spatiale, qui n'ont d'ailleurs pas disparus à bord des avions moins manoeuvrants, ne feront que s'amplifier. Les conséquences neuro-musculaires possibles de vols comportant des accélérations brusques comprennent notamment des réactions biomécaniques, entraînant des difficultés de pilotage. Très peu de recherches ont été effectuées sur les effets sur les activités psychomotrices et cognitives de tels vols à des accélérations en dessous des seuils de perte de connaissance. Parmi les aspects importants de la conception figurent la position du siège par rapport au centre de gravité de l'avion, qui peut avoir une incidence directe sur les accélérations subies par le pilote, à moins que le système de commandes de vol ne soit conçu pour commander les mouvements de l'aéronef autour du poste de pilotage, plutôt qu'autour du centre de gravité. La passivité du pilote (par exemple, lors des phases de pointage automatique des canons ou d'évitement automatisé de missiles etc.) peut aggraver sa désorientation et son sentiment de malaise. Ainsi, les concepteurs devraient tenir compte des problèmes potentiels induits par l'intégration d'un deuxième siège dans un avion de combat très manoeuvrant.

L'accroissement des domaines de tir des armements et la diminution des contraintes liées aux fortes incidences rendra nécessaire l'emploi de nouveaux visuels permettant aux équipages de piloter à l'aide de références se trouvant largement en dehors des champs de vision classiques. Les visuels modernes ne sont pas conçus de façon optimale pour l'affichage simultané de l'attitude du nez et du vecteur vitesse; en plus il est impossible d'afficher les niveaux d'énergie correctement. Les pilotes d'avions de combat à très grande manoeuvrabilité réclameront des visuels montés sur casque dépouillés de toute information superflue. Les pilotes expérimentés se déclarent tout à fait satisfaits des systèmes HOTAS actuels. Par contre, ils sont unanimes à préconiser une plate-forme qui soit simple à piloter; un système de commandes de vol intégré ("la manoeuvrabilité sans souci") est capital pour les futurs avions de combat très manoeuvrants.

La sollicitation physiologique et psychologique accrue du pilote, associée au flux informationnel de plus en plus rapide et au nombre croissant de tâches à exécuter, militent fortement en faveur du concept d'un assistant électronique. L'amélioration de la synergie entre pilote et véhicule, y compris le développement d'interfaces intelligentes, de commandes/visuels sur mesure, et d'interfaces adaptatives (y compris les systèmes de contrôle du pilote), associée à un degré d'automatisation approprié, devrait permettre d'améliorer les performances du pilote et faciliter la concrétisation de tout le potentiel des avions de combat très manoeuvrants. Les principales voies de recherche à suivre sont : les performances cognitives et les performances en équipage, l'interaction entre la performance cognitive et le stress physiologique, et les stratégies de sélection et d'entraînement. Les systèmes de retenue actuels ne suffiront pas pour immobiliser le pilote évoluant dans un domaine de vol sans contraintes ou lors d'une éjection. Etant donné que les moyens actuels de simulation de l'environnement du vol agile s'avèrent inadéquats, de nouvelles capacités de simulation et des activités de recherche en vol seront nécessaires. Des travaux de recherche de base et appliqués seront aussi nécessaires avant de pouvoir profiter pleinement des avantages de la manoeuvrabilité accrue.

Contents

	Page
Executive Summary	iii
Synthèse	iv
Preface/Foreword	vi
Acknowledgements	vii
Human Factors and Medicine Panel Officers	viii
1. Introduction	1
by R.D. Banks, T.J. Lyons and J. Firth	
2. “Operational Need” and “Situational Awareness” Survey	11
by J.Y. Grau and T.J. Lyons	
3. Agility: Definitions, Basic Concepts, and History	21
by P. Le Blaye	
4. Psychological Consequences	39
by J.Y. Grau	
5. Physiological Consequences: Cardiopulmonary, Vestibular, and Sensory Aspects	49
by H. Welsch, W. Albery and W. Bles	
6. Pilot-Vehicle Interface	59
by G. Calhoun, P. Le Blaye and H. Welsch	
7. Selection and Training	99
by J. Linder and W. Tielemans	
8. Simulation	111
by W. Albery	
9. Ejection Seat Capabilities to Meet Agile Aircraft Requirements	121
by L. Specker, J. Plaga and V. Santi	
10. Conclusions	131
by T.J. Lyons	
APPENDIX A – Glossary	137
by P. Le Blaye	
APPENDIX B – High Speed Flight as a System of Medical-Psychological Support of Domination in the Air	141
by V. Ponomarenko	
APPENDIX C – Psychophysiological Problems of Modern and Future Aviation	149
by V. Ponomarenko	
APPENDIX D – Pilot Interviews	155
by F. Knox and M. Stucky	

Preface/Foreword

Working Group #27 was formed under the former Advisory Group for Aerospace Research and Development (AGARD) in January 1997 to study the human factors implications of agile flight. As the Group was formed, it was believed that its focus would be aircraft maneuverability with a consequent emphasis on human physiologic issues related to the acceleration environment. Initially group members were chosen from the acceleration and vestibular research communities. Representatives from each of the nations with new fighter aircraft being developed were included as well as military pilot-physicians and acrobatic pilots. It was also planned to invite aeromedical input from Russian experts.

It soon became evident that the issue was much broader in scope. Among experts in the FMP Working Group #19 of AGARD, the definition of agility had evolved from one involving primarily aircraft maneuverability, to one including weapons and systems agility as well. It became evident that cognitive, control, and display issues also needed to be addressed. So additional representation from the human factors and psychology disciplines were added to the group. Also Mr. Patrick Le Blaye was included as a technical liaison to the engineering community.

Meeting sites were chosen to facilitate communication between the Working Group and aircraft designers, test pilots, and operational pilots. Because we wanted to base our work on real operational needs and realities, we had extensive interactions with NATO pilots from several nations. We interviewed pilots at our formal meetings; we asked them fill out questionnaires; we were formally briefed by pilots on their concept of agility; we visited operational and test squadrons; we asked them to critique our briefings; and throughout the two and one-half years we consulted with pilots extensively. These pilots from France, Germany, Sweden, the United Kingdom, and the United States (USAF & NASA), were indispensable contributors to the Working Group.

The Working Group would also like to express its' sincere appreciation to the local organizers for the hospitality and excellent facilities which we encountered at each location. Six meetings were held over a two and one half-year period:

15,17 April 1997	LAMAS and Istres Flight Test Center, France
19-20 May 1997	Air Warfare Center, Nellis Air Base, Nevada, U.S.
5-8 October 1997	FMV Testing Directorate and F-7 Wing, Linkoping, Sweden
27-19 April 1998	Manching Air Base, Germany
14-16 October 1998	NASA Ames, Edwards Air Base, California U.S.
12-14 May 1999	Air Force Research Laboratory, Wright Patterson Air Base, Ohio, U.S.

Consultants included Dr. R. Banks from Canada, a pioneer in research on multi-axis acceleration. As Russia has had extensive experience in agile aircraft, Dr. (MG ret.) V. Ponomarenko was invited to contribute. His contributions to the Working Group were invaluable. As safe ejection from agile aircraft also appeared to be a significant issue, we asked Mr. Specker, Mr. Plaga, and Mr. Santi to contribute a Chapter on Escape.

Terence J. Lyons, M.D., M.P.H.
Associate Clinical Professor
Wright State University School of Medicine
and
Program Manager, Asian Office of Aerospace Research and Development,
Air Force Office of Scientific Research

Acknowledgements

The members of Working Group #27 would like to thank our hosts at the six different locations where we met for their excellent support and hospitality:

Colonel Lascourreges at LAMAS and at the Istres Flight Test Center, France

LtCol Chris Knapp at the Air Warfare Center, Nellis Air Base, U.S.
Lt.Col. Marc Jouas, Commander 422nd Test and Evaluation Squadron, USAF

Major Ken Lindberg, Major Magnus Fredriksson, and Captain Michael Seidl, FMV Testing Directorate, Sweden
Colonel Krister Backryd and Major Anders Linner, F-7 Wing, Sweden

Mr. Credet at the DASA Test and Manufacturing Center, Manching Air Base, Germany
Mr. Schmidt, Director WTD 61 (German OTC), Manching Air Base, Germany

Lt.Col. James Little at the Flight Test Center, Edwards Air Base, U.S.
Lt.Col James Mueller (USAF) at NASA Ames, California, U.S.

Dr. William Albery at the Air Force Research Laboratory, Wright-Patterson Air Base, Ohio, U.S.

For sharing their expertise and technical consultation, we would like to thank Mr. Michael Grost, Dr. Michael Haas, and Dr. Grant MacMillan. For tireless typing and administrative support, we would like to thank Ms. Etsuko Hiwatashi and Mrs. Masako Taylor from the Asian Office of Aerospace Research and Development and Mrs. Rosey Rodriguez from Brooks Air Base.

We would like to thank the many other pilots who shared their valuable insights with us. Our grateful appreciation to the following pilots, in particular, for their insightful briefings to our Group:

Mr. Jon Beesley, Lockheed
Mr. Vance Brandt, NASA
Lt.Col (ret.) Richard Calwer, Daimler Chrysler Benz
Major Magnus Fredriksson, Swedish Air Force
Lt.Col. Robert Hierl, German Air Force
Lt.Col. Quirin Kim, German Air Force
Mr. Fred Knox, Rockwell-Boeing
Lt.Col. Johan Koeck, German Air Force
Colonel Lascourreges, French Air Force
Mr. Reino Lidvik, Swedish Air Force
Mr. Paul Metz, Lockheed Martin
Maj. Thomas Pitschmann, German Air Force
Lt.Col (ret.) Wolfgang Schirdewahn, Daimler Chrysler Benz
Captain Michael Seidl, Swedish Air Force
Mr. Rogers Smith, NASA
Mr. Marc Stuckey, NASA

The Working Group would also like to thank the audiences of the Lecture Series in Neubiberg, Germany, Preston, Lancashire, and Wright Patterson Air Base, Ohio for their lively participation. They were exceptionally knowledgeable concerning the subject of agile aircraft and the discussion periods provided excellent feedback in many areas including problems with ejection from agile aircraft, likelihood of decompression sickness, and effects of aircraft center of gravity combined with roll rate in producing Gy acceleration, etc. In particular, the Working Group would like to thank Professor Dr.-Ing. Reiner Onken, Universitat der Bundeswehr; Wing Commander Tony Bachelor, Commander, RAF Centre in Aviation Medicine, RAF Henlow; Wing Commander David Gradwell, Consultant Adviser in Aviation Medicine, RAF Centre in Aviation Medicine, RAF Henlow; Mr. Keith McKay, British Aerospace; Mr. Brian Dickison, British Aerospace; and Wing Commander Andy Young, Officer Commanding, Fast Jet Test Squadron, RAF Boscombe Down; Mr. Terry Adcock; Dr. Earl Wood, Mayo Clinic; and Dr. Robert Van Patten.

Human Factors and Medicine Panel Officers

Chairman: Dr M.C. WALKER
Director, Centre for Human Sciences
F138 Bldg – Room 204
DERA
Farnborough, Hants GU14 0LX
United Kingdom

Deputy Chairman: Col. W.D. TIELEMANS
RNLAf/SGO
P O Box 20703
Binckhorstlaan, 135
2500 ES The Hague
The Netherlands

WG 26 Members and (Authors/Co-Authors)

Chairman

DR. T.J. LYONS
Asian Office of Aerospace Research and Development (AFOSR)
Unit 45002, Box 316
APO AP (96337-5002)
United States

Members

Dr. W. ALBERY
AFRL/HESA
2800 Q Street, bldg #824
Wright Patterson AFB, OH 45433-7901
United States

Dr. W. BLES
TNO Senior Research Fellow
TNO Human Factors Research Institute
PO Box 23
3769 ZG Soesterberg
The Netherlands

Ms. G. CALHOUN
AFRL/HECP
2255 H Street, bldg #33
Wright Patterson AFB, OH 45433-7022
United States

Médecin en Chef J.M. CLERE
Laboratoire de Médecine Aéronautique
Centre d'Essais en Vol
91228 Brétigny sur Orge Cedex
France

Dr. J.L. FIRTH
University Hospital
Queens Medical Centre
Nottingham NG7 2UH
United Kingdom

Médecin en Chef J.Y. GRAU
Institut de Médecine Aéronautique
BP #73
91223 Brétigny sur Orge Cedex
France

Mr. Patrick LE BLAYE
ONERA
BA-701
13661 Salon-Air
France

Col DR. J. LINDER
Swedish Armed Force Headquarters
S-107 85 Stockholm
Sweden

Col Dr. W. C.M. TIELEMANS
RNLAf/SGO
Postbus 20703, Binckhorstlaan 135
2500 ES DEN HAAG
The Netherlands

Col Dr. H. WELSCH
Flugmedizinisches Institut des Luftwaffe
Abteilung II- Flugphysiologie
Steinborner Strasse 43
D-01936 Königsbrunn
Germany

Authors/Co-Authors

Dr. R.D. BANKS
Biodynamics Research Corporation
San Antonio, Texas 78230
United States

Mr F. KNOX
The Boeing Company
Mailstop 4C-26
9725 East Marginal Way S.
Seattle, WA 98108
United States

Mark STUCKY
NASA/Dryden Flight Research Center
P.O. Box 273
M/S 1029
Edwards CA 93523
United States

Mr. John PLAGA
AFRL/HEPA
2800 Q Street, room #206
Wright Patterson AFB, OH 45433-7947
United States

Dr. V. PONOMARENKO
Office 12A
Petrovsko-Razumovskaya Alleya, A-83
Moscow 125083
Russia

Mr. V. SANTI
ASC/ENFC, WPAFB OH 45433
Bldg 560, 2530 Loop Rd West
Wright Patterson AFB, OH 45433-7901
United States

Mr. L. SPECKER
AFRL/HEPA
2800 Q Street, room #206
Wright Patterson AFB, OH 45433-7947
United States

PANEL EXECUTIVE

Dr C. Wientjes
BP 25, 7 rue Ancelle
92201 Neuilly-sur-Seine Cedex, France
Tel: +33 (0)1 55 61 22 60/62
Fax: +33 (0)1 55 61 22 99/98
E-Mail: wientjesc@rta.nato.int

This page has been deliberately left blank



Page intentionnellement blanche

1. INTRODUCTION

R.D. Banks*, T.J Lyons, and J. Firth*****

*Biodynamics Research Corporation
San Antonio, Texas 78230
United States

**Asian Office of Aerospace Research and Development
7-23-17 Roppongi
Minato-ku, Tokyo 106-0032, Japan

***University Hospital
Queens Medical Centre
Nottingham NG7 2UH
United Kingdom

1.1 A NEED FOR RESEARCH

“There is an inherent time-lag between the pace of evolution, and maturity, of new propulsion systems, and that of avionics/flight-control. While the former shifts into a “new generation” every ten to twelve years, it takes the latter only four to six.” Dr. Benjamin Gal-Or, 1990 [1].

Benjamin Gal-Or has been one of the leading proponents of high-agility propulsion. Many of his ideas, and those of his contemporary Wolfgang Herbst, are visionary, futuristic and controversial. In a relatively short period of time, these men, and others, have influenced the direction of fighter aircraft design. “High-agility” aircraft are now being tested and flown operationally. This new technology will offer new challenges, and threats, to human operators. Solving the inevitable human factors problems that will emerge will involve questioning established doctrine, and reaching for innovative and imaginative solutions.

The “inherent time-lag” referred to by Gal-Or could apply equally to the time-lag that now exists between the evolution of high-agility flight capability and current human protective/performance technology. There currently exists a technology gap, the precise nature of which is only partly understood. Typically, human factors are considered only after concept, design, and aircraft prototype development, and often after loss of life. Some human factors problems, identified years ago, have never been completely solved. Failure to identify the inevitably unique problems that will attend human exposure to the high-agility flight environment will unquestionably lead to needless loss of life and scarce resources.

High-agility flight will challenge every aspect of human protection and performance. Many old engineering designs and assumptions will be challenged. During the narrow window of opportunity that now exists between concept, test, and widespread operational deployment of high-agility aircraft such as the F-22 and JSF, aggressive research aimed at exploring the problems and solutions will enhance the value of these weapons, and prevent needless loss of life.

1.2 HIGH-AGILITY FLIGHT

The merits of high-agility flight have been hotly debated since the concept was seriously explored by military planners several decades ago. Much emotion has been generated:

“And thrust-vectoring for high angle-of-attack airplanes? Hell, that’s a bunch of crap....you slow down, and you’re dead meat [2].”

“All advanced fighters will be vectoredprevent 60% of all flight accidents....racing cars, cars, buses, trucks, tractors, racing boats, and wheelchairs [3].”

All opinions are based on underlying assumptions regarding the nature of any future air war. The need for high-agility maneuvering may depend on whether future air-combat will occur at beyond visual range, or up close, or both. Short-range air-to-air combat capability may not be important in an era of beyond-visual-range weapons. However, the advent of all aspect missile technology might mean that survivability depends on "point-first" capability if combat occurs within visual range. To achieve a point-first capability, rapid pitch maneuvers will be required [1]. New tactics that trade energy for agility will emerge. If both long and short-range combat capabilities are needed, the successful future combat aircraft will need a design that incorporates the high speed capabilities of current fighters with high agility [4].

The term "high-agility" has been loosely used, but often refers to an aircraft's ability to maintain controlled flight at speeds below that of the airframe stall speed. An agreed definition of "agility" remains elusive. Even among experts in the NATO Four Power Group, the definition of agility evolved from one involving primarily airframe maneuverability, to one including systems and weapons agility as well (see Chapter 3). Airframe Agility encompasses both maneuverability (speed and flight path) and controllability (attitude and thrust). Examples of System Agility would include datalink (Gripen, F-22), scanned array radars (Rafale, F-22), and helmet-mounted displays (Rafale, Gripen, Eurofighter, F-22). An example of Weapons Agility would be off-boresight missiles. These three aspects of agility will be described in more detail in Chapter 3.

By redirecting engine thrust, increased aircraft maneuverability can be achieved. Thrust vectored propulsion (TVP) was the term given to the redirection of engine thrust in flight. There is nothing new in this. TVP was designed into the Harrier many years ago. With the development of high thrust/weight ratios, it has been possible to use TVP systems more flexibly. High-powered TVP adds energy to directional control and can provide for tight, highly agile maneuvering of aircraft in flight. Thrust vectored control (TVC) has been used to describe this capability [5]. As well as "high-agility", TVP enhanced maneuvering has been termed "superagility," "supermaneuverability," and "enhanced fighter maneuverability (EFM) [6]."

1.3 HISTORICAL PERSPECTIVE

The concept of high-agility flight was first described by Wolfgang Herbst and his colleagues at Messerschmitt-Boelkow-Blohm (MBB) during research conducted in the 1970s. This work was a logical progression in the evolution of fighter design and which began 1914. Practical flight experience started with civilian unlimited aerobatic competition pilots. In 1968, the world aerobatic scene was dominated by aircraft with non-symmetric, high-lift aerofoils and pressure carburettion, typified by the Zlin 526 and Yak 18 family. Those without state financial support or major sponsorship were seeking ways to break this stranglehold which reached its apogee at the Hullavington, England World Championships in 1970 with the Yak 50 and "barn-door" 2-aileron Pitts S1-A. Review of the Aresti aerobatic scoring system and theoretical consideration of every manoeuvre of which an air vehicle was capable suggested that symmetrical +/-Gz performance and a power/weight ratio better than the 5 lb/hp then being achieved by Grand Prix/Formula 1 racing cars, would be essential.

Herbst and his group conceived the idea that controlled flight was feasible at high angles-of-attack (AOA) corresponding to airspeeds below the stall speed [7]. Using TVP, Herbst postulated that it would be possible to deeply penetrate this previously forbidden part of the flight envelope, and maintain control throughout. This capability was termed post-stall maneuvering (PST) [8]. High AOAs during PST would allow unprecedented maneuvering potential that could include the ability to quickly "point" the nose of the aircraft at an adversary while maintaining complete control. By redirecting the thrust vector into the yaw plane, it would be possible to introduce a lateral "pointing."

Gal-Or's work, consisting of proof of concept flights using a variety of unmanned scaled models, began in 1987 [9]. This work demonstrated that TVP could double pitch rate [10] and triple turning rate of the F-15 [9]. A manned flight research program involving the X-31 demonstrated several unique maneuvers, including enhanced PST flight, pitch-up from inverted flight, and the "Herbst" maneuver. In air combat maneuvering, the X-31 dominated comparable conventional adversaries by an exchange ratio of 3:1 and kill ratios in excess of 32:1 were reported in offensive mode.

High-agility flight gained popular attention at the 1989 Paris show when the Russian Su-27 demonstrated a maneuver that became known as the Cobra maneuver [11]. Subsequently, the Su-27 demonstrated previously unknown high levels of transient agility [11] [12]. A subsequent version of the Su-27, the Su-37, has fully independent, fully moveable thrust nozzles for each of its two engines. The Su-37 demonstrated superior agility that included backward flight during post-stall loops [13]. An additional maneuver, the 'hook' - or sideways Cobra, was introduced using the Su-35 [9].

In the United States, the Calspan NF-16D variable stability in-flight test aircraft (VISTA) [14], multi-axis thrust vectoring (MATV) demonstrated the Cobra, J-turn maneuver, split-S, and Herbst maneuvers [15]. Another maneuver, the “helicopter” consisted of a flat-spin that allowed continuous pointing at any adversary in any position in the sky [13]. Similar work was conducted on F/A-18 High Angle of Attack Research Vehicle (HARV) [16].

The F-22 Raptor, now in flight testing, will be capable of +/- 20 degrees of pitch thrust-vectoring (TV) [13]. The F-22 will open a new era in aviation that will be characterized by pitch rates 2-3 times those of conventional aircraft [17] and angles-of-attack (AOA) up to 70-degrees [18].

1.4 TACTICAL ADVANTAGES

Very little has been published on the tactical advantages of high-agility as the technology is still developmental and capabilities often classified. From what is available thus far, it appears that the following capabilities may emerge as tactical advantages:

1.4.1 Close-in Combat.

The tactical advantages of a point-first capability arose from the development of all aspect missiles [19] [20] [9], that is, missiles that could lock on the forward aspect of a target. Since fighter pilots would no longer need to tail-chase into a ‘6 o’clock position’, just pointing at the adversary would be sufficient to achieve a kill [7].

1.4.2 Visual Reconnaissance and Ground Attack.

The advantages of high-agility would not be limited to short range, air-to-air combat. The majority of aircraft losses in recent wars have been due to ground attack [21]. Low level tactical maneuvering or automated systems, such as the Automatic Maneuver and Attack System (AMAS), would enhance high-agility capable fighters ability to escape ground or air threats. The dive attack would remain an important tactical option that would be improved by high-agility [21], and high-agility would allow strike fighters to avoid potential ground/air threats [22]. While future ground attack aircraft, such as the Joint Strike Fighter (JSF), might eventually use unmanned fighter versions in this role [23], no existing combination of computers and simulators of appropriate size can yet duplicate the capabilities of a pilot in real-world conditions [24]. Pilots will remain in the ground attack role for the foreseeable future.

1.4.3 Missile avoidance and Laser-break

Superagility may play a role in breaking missile or laser lock-on with maneuvers such as flicks or translations.

1.4.4 High Altitude Operation

The ability to engage in tactical ceiling maneuvering, the requirement for high altitude visual identification and combat maneuvering above 20 km/60,000 feet adds extreme altitude operations and the significant complexities they involve to the multi-role activities now expected of superagile aircraft. That the MiG-31 (designed for Vigilante and Valkyrie), despite all its difficulties, remains in service and is now being up-graded emphasizes the significance afforded by others to this sphere of operations.

1.4.5 Extremely short take-off and landings, ESTOL

All-weather, ‘round the clock, extremely-short take-off and landings, ESTOL into remote strips and small carrier landings in worse weather conditions will involve either yawed approaches, totally automatic, aircraft-based landings or real-time, sensor-fused display directed heads-down finals and touch-down. The necessary velocity vectors and angles of attack will provide flight paths on finals in the blind sectors of even the most generous of “full vision cockpits”, unless nose droop, Corsair II style cranked wings and stork-like undercarriages are re-introduced.

1.4.6 Automatic maneuvering

Automatic gun-laying, multi-target, single run air-to-ground nose pointing, missile and laser avoidance and “optimoving (optimum maneuvering, the instantaneous adoption of the optimum aerobatic figure to achieve the required tactical manoeuvre from a given position, vector velocity and energy state with the performance available)” together with post-end gaming (the constructive use of G-LOC). will all involve violent maneuvering and, for safety and economic reasons, require departure recovery from far out of envelope states rather than abandoning the aircraft by ejection as is now the rule.

1.4.7 Rules of Engagement

Superagility is mandatory if restrictive Rules of Engagement are imposed. Visual identification, VID and graded responses place aircraft and aircrew at immediate disadvantage and hazard.

1.4.8 Night

Though half the World is night, night operations using night vision goggles (NVGs), even with 120° fields of view, will increase rather than reduce the need for superagility as well as the opportunities for disorientation.

1.4.9 Multiple Roles Requirements

The carriage of ad hoc, asymmetric and incompatible loads, together with the retention of stores as long as possible, despite induced asymmetry by partial deployment as dictated by operational reality, require superagile aircraft capability and TVC. Multi-roling, including ground attack, guarantees inadvertent close combat and being bounced under conditions of the opposition’s choosing.

1.4.10 Stealth and Surprise

Stealth, surprise, ground attack and the use of forward, remote and exposed landing grounds in desperate situations, all inevitable in the light of the present strategic situation and NATO’s need for economy, enhance the bouncing hazard, in which superagility is the only means of survival and of turning the tables on the bouncer who is now committed to attack. The reverse, achieving surprise by use of terrain, masking and weather, will depend on superagility.

1.4.11 Efficiency

Efficiency includes economy to extend tactical and strategic envelopes. Achieving trim symmetry and minimal aerodynamic drag despite asymmetric loads; corner speed optimization; range and endurance through fuel efficiency and economic supercruise under operational conditions are all facets of superagility.

1.4.12 Safety

The ability to exploit extreme aerodynamic envelopes also provides the means to recover from situations and departures, the present inevitable consequences of which are loss of aircraft and, at best, crew recovery by ejection. Just as in aerobatic aircraft, parachutes should be unnecessary. All aerobatic aircraft departures will be convertible into spin and therefore recoverable, so ejection in superagile aircraft should be necessary only for combat damage or other major structural failure.

1.4.13 Superagile UAVs

Tactical un-manned air vehicles, TUAVs and the remote piloting of super-agile UAVs, where superhuman envelopes are essential to mission accomplishment, only remove the on-board human component of system agility. Not having a “man on the spot”, and the extended communications lag with the enhanced requirement for UAV autonomy, actually increases the other demands of superagility.

1.5 TACTICAL DISADVANTAGES

There are two particular disadvantages associated with high-agility maneuvering: 1) low energy states following the PST maneuver, leaving the fighter vulnerable to re-attack; 2) the spin-like characteristic of the PST roll maneuver [19]. To prevent energy decay, Herbst has predicted average PST durations of 5 s [1].

With the possibility of pitch rotations of 400 degrees per second, it is possible that EFM maneuvers will involve completion of pitch-up to greater than 70 degrees AOA and recover to straight and level flight in considerably less than 5 s [1]. While the design of such a capability may be possible, the pilot will experience both impact and sustained acceleration and the effect of the combination of these accelerations is largely unknown. The effects of an abrupt spin-like maneuver, such as a rapid Herbst maneuver, during high and changing +Gz acceleration, is also unknown.

1.6 PHYSIOLOGICAL STRESS

The principle physiological effect of high-agility flight on pilots will relate to abrupt changes in magnitude and/or direction of acceleration experienced by the pilot. Acceleration has been categorized as “impact” (less than 1-second duration) or “sustained” acceleration (greater than 1-second duration). Sustained acceleration is important in aircraft as a result of centrifugal force during high velocity turns. Previously, impact acceleration was associated with collisions (crashes), turbulence, or ejection escape. Pilots of high-agility capable aircraft will experience both impact and sustained acceleration during maneuvers that may be complete in several seconds [1].

While it is possible that peak Gz loads will be higher than those currently experienced, very short G durations might preclude physical harm [20] and some have claimed that peak +Gz may actually decrease during high-agility maneuvers [3]. Nevertheless, angular acceleration will be a new, potentially dangerous feature [25]. Herbst predicted the following maneuver characteristics: 1) 5 s PST average duration; 2) 10% of total engagement time in PST; 3) lower G-level by about 1 G, and; 4) lower maneuvering speeds by about 0.1 M [8].

Some prediction of the nature of acceleration stress can be made by considering several defined high-agility maneuvers. The Herbst maneuver consists of an abrupt pitch-up to a high AOA in the PST envelope followed by a 180 degree yaw leading to a nose-down inverted attitude and low airspeed. Recovery then allows the aircraft to reverse direction within a very short turning radius. The pilot would start the Herbst from +Gz, experience increased +Gz of short duration due to pitch, and experience additional increased +Gz due to aircraft decelerating profile drag. Then, depending on entry speed, seat back angle, and time at high AOA, the pilot would experience 0 Gz or -Gz before +/-Gy begins during the yaw phase. If stable velocity is achieved prior to yaw, the pilot would experience +1 Gx (gravity).

Tamrat has compared the Herbst maneuver to a spin [19]. The magnitude of yaw-induced Gy would vary with the distance of the cockpit from the center of aircraft rotation [26]. On completion of the yaw, in the nose down attitude, the pilot would experience 0 Gz and increased +Gx during energy recovery, and +Gz during dive recovery (possible “push-pull” effect). Current aircraft attitude flight instrument depictions would make spatial orientation a problem during this maneuver, especially during low visibility conditions. The projected G changes for various maneuvers are summarized in Table 1.1.

Table 1.1 Anticipated Acceleration Variations Associated with Currently Projected High-Agility Flight Maneuvers

Maneuver	+Gx	+/-Gy	+Gz (entry)	Angular Acceleration direction	Transitions	Comments
Herbst	→ then ↑	.↑ then →	↑↑ then → to 0 or -Gz	Lateral	1. 0 Gy ! +/-Gy 2. +Gz ! 0 Gz (or -Gz) ! +Gz 3. 0 Gx ! +/- Gx 4. +/- ang accel	1. Spatial orientation 2. Push-pull effect (PPE)
Cobra	→ then ↑	N/A	1. ↑↑ then → to 0 or -Gz 2. -Gz then +Gz	Pitch	1. +Gz ! -Gz ! Gz	1. Spatial orientation 2. PPE
Voll reversal	→ then ↑	1.↑ then → 2.→ then ↑	↑↑ then → to 0 or -Gz	Lateral	1. 0 Gy ! +/-Gy 2. +1 Gz ! +Gz ! 0 Gz (or -Gz) ! +Gz 3. 0 Gx ! +/- Gx 4. +/- ang/trans accel	1. Spatial orientation 2. Possible PPE
Pitch reversal	→ then ↑	N/A	1.↑↑ then → to 0 or -Gz then ↑ Gz 2. ⇨ to -Gz then ↑ 0 or +Gz	Pitch	+Gz ! -Gz ! Gz	1. Spatial orientation 2. Possible PPE
Yaw reversal	N/A	↑ then →	N/A	z-axis	0 Gy ! +/-Gy ! 0 Gy	
Roll reversal	N/A	N/A	N/A	Roll	Angular acceleration changes	
Axial reversal	1.⇨ then ↑↑ 2. ↑↑ then ⇨	N/A	N/A	N/A	+/- Gx	
Lateral jink	N/A	↑↑ then ⇨	N/A	Inertial	+/- Gy	
Vertical jink	N/A	N/A	1. ↑ then → to 0 or -Gz then ↑ Gz 2. → to -Gz then ↑ 0 or +Gz	Inertial	+/-Gz	

During a Cobra maneuver, the pilot would start from +Gz and experience rapidly increased +Gz due to pitch and drag (similar to the Herbst maneuver). When stable at high AOA, with no pitch movement, 0 or -Gz would occur. On recovery, nose down pitch would result in increased -Gz that would vary with the distance of the pilot from the center of pitch rotation [26]. The ability to recover from the Cobra may be limited by the pilot's -Gz tolerance. Negative AOA might occur during energy recovery with increased +Gx as the aircraft accelerates out of the maneuver (again, possible push-pull effect). Depending on exit speed, the maneuver could be repeated, or the pilot might unload to 0 Gz to recover energy. These projected G changes are displayed in Table 1.1. As with the Herbst maneuver, spatial orientation will be a problem in poor visibility conditions. In-flight recordings from a TVP modified F-15 showed G variations during pitch of -1.5 Gz to +4 Gz, -1 Gy to +1 Gy, and - 1 Gx [27].

While +Gz will be less than current aircraft, and of shorter duration, it will be more frequent. Negative Gz exposure will be much more frequent than currently experienced. Zero Gz will be frequently experienced, both as an energy recovery tactic and during maneuver transitions. Gy exposure, now rarely experienced, will become frequent during pointing and escape maneuvers.

Gx exposures will increase in magnitude as propulsion systems and air braking systems improve. Because of the unprecedented degree of controllability afforded by thrust vectoring, rapid changes in magnitude and direction involving these accelerations will occur. Superimposed on translational accelerations will be angular accelerations.

1.7 THE CURRENT KNOWLEDGE GAP

Virtually all of our current knowledge of aviation physiology comes from conventional, non-agile flight applications. Very little applicable published information exists related to the human consequences of exposure to agile flight. Most of what exists is found in the non-peer reviewed literature. It is evident that “surprises” will emerge as our knowledge and experience with this innovation increases. We will be challenged in areas as diverse as cockpit design, visual/vestibular illusions, instrumentation, escape system design, and human performance. Past assumptions in all of these areas will be reviewed.

A major problem will be protection against acceleration threats. The old g-suit designs, including recent innovations such as ATAGS and STING, may not work. In the past, laboratory tools used in acceleration research, such as the human centrifuge, were usually capable of generating +Gz only, and incapable of -Gz. Gx and Gy were generally uncontrolled and regarded as artifact. While a small fund of current knowledge might be applicable to high agility flight, with great caution, properly controlled studies on the effects of multi-axis acceleration have yet to be done.

Relatively little work has been conducted on the effects of -Gz. It has been estimated that about 30 good studies exist on the effects of -Gz, most conducted during WW II or soon after. These studies illustrate the role of the parasympathetic nervous system in adapting to -Gz. The physiology of -Gz was partly reviewed in 1992 in a discussion paper on bradycardia during -Gz [28]. A previously unidentified problem, persistent vertigo following -Gz (termed the “wobblies”), was recently described [29]. Almost no research had been done on transitions between +/- Gz. The recently identified “push-pull effect” [30] may be important in this regard. Although the push-pull effect was demonstrated in 1959 [31] and accidents were documented in civil aviation by Mohler in 1972 [32], no further work was undertaken until 1992. Since then several papers have confirmed the push-pull effect [33] [34] [35] [36]. Researchers in Canada, Israel, and the United States have implicated the push-pull phenomenon in causing the military aircraft accidents [37] [38] [39] and aside from education efforts, no new technology to solve this problem has been developed.

In terms of flight instrument design, pilots rely on flight instruments as their primary defense against visual and vestibular illusions and loss of situational awareness. The various heads up displays (HUD) designs, attitude indicators (AI), and associated primary flight instruments allow the pilot to determine spatial orientation relative to the earth in degraded visibility. Translational and rotational accelerations are known to affect spatial orientation through induced vestibular and proprioceptive illusions. Loss of spatial orientation can lead to loss of situational awareness. Never solved previously, aircraft crashes attributed to loss of situational awareness continue to occur [40].

Current AI/HUDs display a two dimensional depiction of the aircraft attitude relative to the horizon. Neither instrument effectively displays the yaw or velocity vector. Most airspeed indicators are pneumatically driven and become unreliable below the stall-speed. Thus, the pilot of an high-agility capable aircraft, flying at high-AOA during PST, employing current flight instrument displays, would receive inadequate orientation and velocity information. A HUD design in the X-31 depicting the velocity vector has proven confusing [7]. Vestibular illusions, not yet identified, will lead to pilot misperceptions of flight orientations that may be difficult to counter with existing instrument displays. Improved instrumentation will be needed to counter the severe vestibular illusions that will certainly be associated with high-agility flight [41]. Cord discussed the problem of situation awareness and the need to better integrate the pilot with the aircraft [20].

Spatial orientation of pilots will be especially challenged by lateral accelerations (Gy) that will be experienced during angular acceleration in maneuvers such as the Herbst maneuver. Similar forces are experienced by civilian light aircraft aerobatic pilots, with an important difference - high agility fighter pilots will experience lateral Gy in combination with long radius angular acceleration. The effects of this combination are unknown and will likely be associated with currently unidentified vestibular illusions [20]. While the natural tendency of any pilot might be to reposition the head in the direction of rotation (thus converting lateral angular motion to pitch motion), preoccupation with tactics may not allow orienting compensating movements. Thus, there will be a large combination of possible disorienting stimuli.

Short radius yaw rotational movements that occur in helicopter flight and vertical take off and landing (VTOL) fixed wing aircraft, subject pilots to rotation around the z-axis. The NF-16D MATV ‘helicopter’ maneuver is an example of a similar high-agility yaw maneuver [13]. The speed of rotation in high-agility capable fighters may be significantly greater than that seen previously, and may be combined with other acceleration stress. Head movements during z-axis rotation may provoke disorientation and motion sickness [40] [42].

Psychological challenges to pilots included faster information flow (estimated to be two to three times faster than conventional fighters). Although the requirement to think ahead is common to all aircraft, this becomes more urgent in agile aircraft due to the shorter time domain. Human factors and crew resource management will be redefined in the high-agility environment.

1.8 THE NEED FOR HUMAN RESEARCH

The lack of understanding of the physical demands imposed by high-agility flight has been described as the “forbidden human space-time agility domains.” [26] “Understanding these complex rigid-body translational, rotational, gyration, and gyroscopic phenomenon, requires reassessment of well-established concepts.” [26] While some speculation has occurred on the effects of G in high-agility flight [10], it is based on gradual or rapid G-onset studies not representative of high-agility accelerations. Gal-Or, one of the few engineer-researchers who has shown an appreciation of human factor limitations in these aircraft has strongly recommended DES-centrifuge research into these problems [10], and has included the need for research into pilot tolerances as part of his methodology [26]. Tedor has described the problems that could be anticipated and the lack of resources to solve them. He emphasized the problems of G-LOC and visual/vestibular illusion [43].

Several important illusions in non-agile aircraft were identified only after the loss of aircraft, a notable example being the somatogravic illusion which occurs during take-off or rapid acceleration in fighter aircraft. We can expect history to repeat itself if the need for research is not understood, and work not commenced.

1.9 REFERENCES

- Gal-Or, B. *Maximizing agility and flight control by thrust vectoring*. 1990, Technion-Israel Institute of Technology: Haifa, Israel.
- Scott, W. and C. Yaeger, *Pragmatic realist on military technology's future*. Aviation Week and Space Technology, 1997(October 13, 1997): p. 58.
- Gal-Or, B. *An old-new European debate on thrust vectoring*. International Journal of Turbo and Jet Engines, 1997. **14**(4).
- Herbst, W. *Dynamics of air combat*. Journal of Aircraft 1982. **20**: p. 594-9.
- Proctor, P. *Israelis test thrust vectoring*. Aviation Week and Space Technology, 1998: p. 81.
- Herbst, W. *Breaking the stall barrier*. Aerospace Engineering, 1987(November 1987): p. 27-9.
- Dornheim, M. *X-31 flight tests to explore combat agility to 70 deg AOA*. Aviation week and Space Technology, 1991(March 11, 1991): p. 38-41.
- Herbst, W. *Supermaneuverability*. 1983, Messerschmitt-Bolkow-Blohm GMBH: Ottobrunn bei Munchen.
- Gal-Or, B. *Thrust vectoring for flight control and safety: a review*. International Journal of turbo and Jet Engines, 1994. **11**: p. 119-36.
- Gal-Or, B. *Tailless Vectored Fighters. Theory, Laboratory and Flight Tests*. 1991, Technion - Isreal Institute of Technology: Technion City, Haifa, Isreal.
- Skow, A. *An analysis of the Su-27 flight demonstration at the 1989 Paris airshow*. in *SAE Technical Paper Series*. 1990. Dayton, Ohio: SAE.
- North, D. *Aviation Week editor flies top Soviet fighter*, in *Military Aircraft Pilot Reports*. D. North, Editor. 1990, McGraw-Hill: New York. p. 58-68.
- Discovery, *Wings: Air Dominance*. 1998, Discovery Channel.
- North, D. *VISTA primed for research, training*, in *Military Aircraft Pilot Reports*. D. North, Editor. 1995, McGraw-Hill: New York. p. 162-8.
- North, D. *MATV F-16 displays high alpha benefits*, in *Military Aircraft Pilot Reports*. D. North, Editor. 1994, McGraw-Hill: New York. p. 169-76.
- Smith, B., *USAF to press thrust-vectoring tests on limited budget*, in *Military Aircraft Pilot Reports*, D. North, Editor. 1996, McGraw-Hill: New York. p. 177-80.
- Gal-Or, B. *Western vs Eastern fighter technologies beyond 2000*. International Journal of turbo and Jet Engines, 1994. **11**: p. 113-8.
- Dornheim, M. and S. Kandebo. *F-22 test flights begin at Edwards*. Aviation Week & Space Technology, 1998(May 25, 1998): p. 23-4.
- Tamrat, B. *Fighter aircraft agility assessment concepts and their implication on future agile fighter design*. in *AIAA/AHS/ASEE Aircraft Design, Systems and Operations Meeting*. 1988. Atlanta, Georgia: American Institute of Aeronautics and Astronautics.

20. Cord, T., M. Detroit, and D. Multhopp. *Is an agility requirement needed for fighter aircraft?* (manuscript). 1990, Wright Research and Development Centre.
21. Herrick, P. *Air-to-ground attack fighter improvements through multi-function nozzles*. in *SAE Aerospace Atlantic*. 1990. Dayton, Ohio: Society of Automotive Engineers.
22. Brown, D. *Joint strike fighter: one aircraft, many missions*. *Aviation Week and Space Technology*, 1998(May 25, 1998): p. S3 - S18.
23. Fulghum, D. *JSF to spawn black derivatives*. *Aviation Week and Space Technology*, 1998(March 9): p. 55.
24. Zaloga, S. *UAVs gaining credibility*. *Aviation Week and Space Technology*, 1998(January 12, 1998): p. 93-5.
25. Gal-Or, B. *Safe jet aircraft*. *International Journal of turbo and Jet Engines*, 1994. **11**: p. 1-9.
26. Gal-Or, B. *Thrust vectoring: theory, laboratory, and flight tests*. *Journal of Propulsion and Power*, 1993. **9**(1): p. 51-8.
27. Gal-Or, B. *Proposed flight testing standards for engine thrust vectoring to maximize kill ratios, post-stall agility and flight safety*. *International Journal of turbo and Jet Engines*, 1995. **12**: p. 252-268.
28. Banks, R. and G. Gray. *"Bunt bradycardia": two cases of slowing of heart rate inflight during negative Gz*. *Aviat Space Environ Med*, 1994. **65**: p. 330-1.
29. Williams, R., *et al*. *Adverse effects of Gz in civilian aerobatic pilots (abstract)*. *Aviation, Space, and Environmental Medicine*, 1998. **69**(3): p. 201.
30. Banks, R., *et al*. *The push-pull effect*. *Aviat Space Environ Med*, 1994. **65**: p. 699-704.
31. von Beckh, H. *Human reactions during flight to acceleration preceded by or followed by weightlessness*. *Aero Med*, 1959. **30**: p. 391-409.
32. Mohler, S. *G effects on the pilot during aerobatics*, . 1972, FAA.
33. Lehr, A., *et al*. *Previous exposure to negative Gz reduces relaxed +Gz tolerance (abstract)*. *Aviation, Space and Environmental Medicine*, 1992. **63**(5): p. 405.
34. Prior, A. *Negative to positive Gz acceleration transition*, in *AGARD Lecture Series No 202*. 1995. USA, Germany, UK: AGARD.
35. Banks, R., *et al*. *The effects of varying time exposure to -Gz on subsequent decreased +Gz physiological tolerance (push-pull effect)*. *Aviat Space Environ Med*, 1995. **66**: p. 723-7.
36. Goodman, L. and S. LeSage. *Physiological responses to a tilt table simulation of the push-pull effect (abstract)*. *Aviation, Space, and Environmental Medicine*, 1998. **69**(3): p. 202.
37. Banks, R. and M. Paul. *Death due to push-pull effect*. *Aviation, Space, and Environmental Medicine*, 1996 (67th Annual Meeting of the Aerospace Medical Association).
38. Shamiss, A., L. Chapnik, and N. Yoffe. *Physiologic incidents in the Israeli Air Force 1994-1996 (abstract)*. *Aviation, Space, and Environmental Medicine*, 1998. **69**(3): p. 232.
39. Michaud, V., T. Lyons, and C. Hansen. *Frequency of the "push-pull effect" in USAF fighter operations*. *Aviat. Space Environ. Med.* (in press), 1998.
40. Gillingham, K. and F. Previc. *Spatial Orientation in Flight*, in *Fundamentals of Aerospace Medicine*, R. DeHart, Editor. 1996, Williams and Wilkins: Baltimore. p. 309-97.
41. Pancratz, D., J. Bomar, and J. Raddin. *A new source for vestibular illusions in high agility aircraft*. *Aviat. Space Environ. Med.*, 1994. **65**: p. 1130-3.
42. Banks, R., D. Salisbury, and P. Ceresia. *The Canadian Forces airsickness rehabilitation program, 1981-1991*. *Aviat. Space Environ. Med.*, 1992. **63**: p. 1098-101.
43. Tedor, J. *Flight simulation*. *Aerospace Engineering*, 1993(August): p. 21-4.

This page has been deliberately left blank



Page intentionnellement blanche

2. "OPERATIONAL NEED" AND "SITUATIONAL AWARENESS" SURVEY

J.Y. Grau* & T.J. Lyons***

*Institut de Medecine Aerospatiale du Service de Santé des Armées
B.P.73, Bretigny-sur-Orge Cedex F-91223
France

**Asian Office of Aerospace Research and Development
7-23-17 Roppongi
Minato-ku, Tokyo 106-0032, Japan

2.1. INTRODUCTION

Determining the human consequences on crews of flying agile aircraft is not an easy task, because of the lack of operational feedback regarding missions performed with these aircraft. A way to envisage potential human consequences is to transfer the experience acquired on agile aircraft prototypes and on last generation combat aircraft to the operational situations these future agile aircraft are expected to meet. To this end, the Working Group #27 carried out a survey with pilots of last generation combat aircraft flying in the Air Forces represented in the working group.

In order to envisage the different fields of potential human consequences, the Working Group #27 led two actions between April 1997 and October 1998 :

- First, interviews conducted with experienced military fighter pilots and test pilots concerning the operational need and consequences of agile aircraft flight on physiology and pilot-vehicle issues ;
- Second, questionnaire survey developed to address psychological consequences of agile aircraft flights and its consequences on "situational awareness" and mission performance.

2.2 "OPERATIONAL NEED" SURVEY

Aircrews interviewed included 23 U.S. pilots (consisting of 5 NASA Test Pilots, 13 USAF Air Warfare Center Pilots, and 5 USAF Pilot-Physicians), 11 Swedish Air Force operational pilots, 3 German Air Force test pilots, and 2 French pilots. After the discussions, the aircrews were asked to complete an anonymous questionnaire. (Note, the French pilots were interviewed before the questionnaire was completed and so their views are represented in the pilot comments, but not in the actual questionnaire results.) In addition to the questionnaire results, one-on-one interviews were conducted with many of the pilots. A worldwide representation of most agile aircraft was achieved by surveying pilots experienced with the X-31, F-18 HARV, F-15 Active, MATV, Harrier, F-22, F-18, MIG-29, Rafale, Gripen, and Eurofighter.

As a part of the questionnaire, the aircrew members were asked background questions concerning their flying experience. The remainder of the questionnaire involved rating the utility of various aircraft capabilities (e.g., high angle-of-attack (AOA)/post-stall maneuvering, negative G maneuvering, high (+12) Gz maneuvering) with regard to their contribution to air-to-air combat performance. A seven point scale was used to rate the perceived contributions to air combat effectiveness. Specifically, ratings ranged from 1 for "Not at all useful", 3 for "Slightly useful", 5 for "Moderately useful", to 7 for "Very useful."

The aircrews were, on the average, very experienced with an average flying time of 2,589 hours (range 900-9,000). A summary of the ratings for agility factors is shown in Table 2.1. Note that some pilots did not have experience with helmet-mounted sights or advanced anti-G suits. Hence, they did not rate these systems. Combat Edge (the USAF positive pressure breathing system for G protection) and the Advanced Technology Anti-G suit were included as known benchmarks against which to judge the pilot responses.

Pilots rated helmet-mounted sights, high AOA maneuvering, and high G capability all highly. Ratings of negative Gs varied widely among the responders. Some interesting differences were noted in the responses of the Swedish pilots compared with the U.S. and German pilots (see Table 2.2). On the average, Swedish pilots valued airframe agility (capability to pull +12 Gz and -Gz) less. This could be due to several factors including (1) lower average flying

experience (flying hours) in the Swedish pilots interviewed, (2) the Swedish pilots included mainly operational pilots rather than test pilots or (3) national differences.

In summary, the pilots surveyed viewed the capabilities afforded by agile aircraft as useful for combat. The following sections provide additional detail from the questionnaire data and debriefing comments that specifically pertains to human factors issues, including physiologic problems, the pilot-vehicle interface, selection, and training. A last section re-examines the pilots' view of agile flight.

Table 2.1 Summary of Pilot Ratings of Agile Aircraft Capabilities

Aircraft Capability	Average Rating	Range of Ratings	Number of Responses
Helmet mounted sight	6.6	5-7	8
High AOA/nose pointing	6.2	1-7	35
+12 Gz	5.7	3-7	34
Negative Gz	3.2	1-7	34
Combat Edge	5.7	3-7	24
Adv. Technology Anti-G Suit	5.0	3-7	14

Table 2.2 Comparison of Pilot Ratings for Three Countries

Aircraft Capability	U.S.	Sweden	Germany
Helmet mounted sight	6.5	No response	7.0
High AOA/nose pointing	6.2	4.8	6.7
+12 Gz	6.0	4.9	6.7
Negative Gz	3.7	2.1	3.3

2.2.2. Physiologic Problems

High AOA Flight: X-31 pilots described high AOA flight as feeling “unnatural” or “bizarre” at first, but they quickly adapted and denied any adverse physiologic sensations.

Acceleration Exposures: In the X-31, the +Gz exposure was generally limited to a brief +6 Gz pulse that decreased rapidly as airspeed decreased. X-31 pilots also experienced little negative Gs and almost no +/-Gy (side-slip).

Active Control of Aircraft: Pilots not in active control of the aircraft also related some adverse physiologic sensations. For example, Swedish pilots related some motion sickness symptoms related to automatic guns aiming.

+12 Gz: Pilots recognize that the G induced loss of consciousness (G-LOC) problem has not yet been solved. Pilot predictions concerning the physiologic problems likely at +12 Gz also included discomfort, loss of situational awareness/disorientation, fatigue, degraded vision, decreased mobility, complaints about “cumbersome” equipment and concern about back/neck injury.

-Gz: The use of negative G's was controversial. Many of the test pilots saw definite operational applications of negative G flight. Comments included “Need to be trained to think of using negative Gs. Could be a life saver.” Other pilots, including many of the operational pilots, did not see a need for negative G maneuvering: “I do not need negative Gs.” “I do not use it”.

We were impressed however, at the interviewed pilots' high level of negative Gs that had been experienced at sometime in their career. Listed below are the maximum negative Gs the pilots reported experiencing during several categories of maneuvers:

Collision Avoidance: 4.8, 3.0, 2.3, 2
Acrobatics, Spin test, “Fun”: 3.2, 3.0, 3.0,--
Structural load testing: 3.2, -- -- --
Guns jink, missile avoidance: 3.0 2.0, 1.6,--
Lantirn bunt: 2.7, -- -- --

Thus, many of experienced pilots had actually experienced quite high levels of negative Gs. Pilot complaints concerning the physiologic problems at negative Gs included “Big time discomfort”, red out, loss of situational awareness/disorientation, and an inability to “remain in the seat.”

2.2.2. Pilot-Vehicle Issues

Psychological Challenges: Psychological challenges to pilots included faster information flow. Pilots thought that the requirement to think ahead would become more urgent in agile aircraft due to the shorter time domain. Pilots predict that anticipation will become more difficult as aircraft agility increases.

2.2.2.1. Displays

Head-up-Display: the HUD is “not useful when you’re looking over your shoulder”– a helmet-mounted display is needed.

Helmet-mounted Display (HMD): Pilots were enthusiastic in endorsing the requirement for HMDs, but requested that “clutter” on the display be kept to a minimum. “Vision is the most valuable sensor and should not be used for housekeeping.”

Pilots were unanimous in demanding good visibility through the HMD – no “eye patch over one eye.”

Test pilots felt that they were unable to adequately evaluate HMDs during short test programs. Like the HUD, pilots estimated that a HMD takes approximately 50 hours to get used to: “At first I never saw it.”

Various possibilities for alternative displays were discussed with the test pilots that we interviewed. The pilots had mixed opinions on tactile and auditory displays. Positive comments were noted concerning three-dimensional auditory displays, although some stated that the pilot could easily ignore the aural tone. Others complained about too many “beeps” and “squeaks.” The need for some additional cueing concerning aircraft energy state was the most frequently mentioned requirement anticipated by the pilots interviewed. Proprioceptive cues were mentioned as a possibility for use in cueing management. Requirements for cueing pilots on threats, ground proximity, fuel status, velocity vector, etc. were also noted. Cues need to be carefully chosen. For example, pilots said that for ground avoidance they would respond to a “break X”, but might ignore more subtle cues (e.g., aural).

High AOA and Velocity Vector: One pilot related while descending into a scattered cloud bank at 11,000’ he was “startled” by his rate of descent. Simultaneous display of nose position and velocity vector can be problematic (e.g. at AOA of 70 degrees). “The velocity vector between your feet can be a real problem.”

Management of Energy State: Several pilots also commented that it was “Easy to command high AOA when you really do not want it.” The X-31 was described as a “drag bucket.” “No real sensation that you’re coming down this fast (like a sky diver) ...need something that says that it is time to break off. Need some kind of cueing.” Tactile cueing of high AOA state/post stall was incorporated into the X-31 for this reason. An improved method of conveying to the pilot his rate of descent was recommended.

Yaw Rates: Responses included comments concerning high yaw rates (guns tracking) and the need for wider horizontal field-of-view for the HUD.

2.2.2.2. Controls

Integrated Flight Control System (IFCS): Pilots were also asked about “lessons learned” concerning high AOA flight. Many pilots commented on the importance of incorporating “Carefree Maneuvering” or integrated FCS into highly maneuverable/thrust vectored aircraft. Virtually all of the X-31 pilots commented that the integrated flight controls were very easy to learn – “Easy but radically different”, “a dream for a test pilot,” “Make it carefree then it allows you to do other things.” Felt unnatural, very unnatural immediately ... “but easy to learn.”

Conventional Controls: The experienced pilots stated that hands-on-throttle-and-stick concept (HOTAS), as it is, was not a limiting factor. Although the 50 functions on the control stick seemed formidable to the non-pilot, these experienced pilots did not feel that HOTAS represented a problem. Thus, the majority did not feel, based on their experience, that alternative controls were needed.

Alternative Controls: Pilots thought that current touch panel technology was not reliable enough; they called it “Fist on Glass” and suggested that it might be useful, for example, for an “on-off” function. For voice-based control, one pilot commented: “I can do it faster than I can say it.” Pilots thought that current voice recognition technology was not reliable enough and worried about problems with surrounding auditory signals from anti-G straining maneuvers, oxygen breathing noises, etc.

Auto-GCAS: Regarding automatic ground collision avoidance systems, pilots commented: “Nothing wrong with that.” “Way of the future.” “The Russians have done it for years.” Pilots also saw a need for automated maneuvers in the future.

2.2.3. Selection, Training, and Simulation

The Harrier flight control system presents a high workload to the pilot. There is a consequent high risk of cognitive failure and a higher accident rate. Training for Harrier pilots takes 8 months compared to 4.5 months for other U.K. fighter pilots. Only those pilots who have performed well are selected for Harrier training.

This was in contrast to the X-31 Program with its integrated flight control system. The X-31 was “easy to learn”, “not much training was needed”, and “2-3 flights were sufficient” to get the most performance out of the aircraft. Pilots state that simulation of the agile environment may not be adequate: “inadequate visuals, no motion”; however, they felt it “...good for switchology.”

2.2.4. Pilot View of Future Requirements

Need for Agile Aircraft: Whether future pilots will be able to avoid close in combat in the future is of course a controversial question. Off-boresight capability, while a distinct combat advantage, was noted to be of offensive utility only. Avoiding close-in-combat was noted to depend on successfully acquiring, identifying (visual ID), and subsequently destroying 100% of the targets. This might not always be possible in small arenas, with rapid aircraft closure rates, and with limitations imposed by politics and rules of engagement. Opinion about super manoeuvrability: “Every capability that the others do not have is a capability. Any capability is one to be explored and you do not have to use it every time.”

The aircrew commented on the many potential advantages conferred by vectored thrust including improved close in air combat kill ratio, short take off and landing capability (STOL), efficiency with asymmetric loads, availability of the full envelope for collision avoidance (“Half the world is negative”), and the ability to make tailless aircraft with stealth and other advantages. The test pilots that we interviewed were convinced that the weight and cost penalties for adding vectored thrust capabilities were minimal.

2.2.5. Limitations of "Operational Need" Survey

One limitation was that the sample included only 37 highly experienced pilots. Also, there was a wide variation in the individual responses, especially for high AOA maneuvering and negative Gs. Pilots generally responded with regard to their particular flying experience and the flight environment varied markedly from aircraft to aircraft. For example, the X-31 flight control system did not generate any side-slip and consequently X-31 pilots experienced minimal Gy accelerations. In the HARV, on the other hand, there was considerable side-slip. The HARV pilots commented that although it felt very unnatural, it was very controllable. In another example, the X-31 Program was characterized by only close in combat at speeds below 325 knots in the Mojave Desert with an IFCS. Thus, it may not be possible to generalize X-31 pilot responses to other scenarios.

During interviews, the pilots initially reported no adverse effects of high AOA maneuvering. X-31 pilots, for example, all stated that there were few adverse sensations experienced during agile flight regimes. On more detailed questioning, however, they related that although they experienced no adverse physiologic sensations when “flying in a clear sky”, such sensations would be more likely in adverse weather conditions.

2.3. "SITUATIONAL AWARENESS" SURVEY

One specific questionnaire was developed to address the following topics:

- Identification of cognitive constraints,
- Relationship between cognitive and physiological constraints,

- Situational awareness,
- Psychological consequences on performance,
- Aid systems,
- Crew training and practice.

The 15 question questionnaire was anonymous and made up of open and closed questions. The questionnaire is in appendix 1. Twenty-nine pilots, representing 5 countries answered it:

- 3 pilots from Germany,
- 12 pilots from Sweden,
- 5 pilots from the Netherlands,
- 1 pilot from the US,
- 8 pilots from France.

These pilots had never flown an agile aircraft (in the sense of the definition used by the Working Group #27). They flew last generation high performance aircraft, equipped with the latest weapons, navigation, communication and interface systems. These 29 pilots gave feedback on the following aircraft:

- Falcon 15,
- Falcon 16,
- Falcon 18,
- MiG 29,
- JAS 39,
- Mirage 2000 C-RDI, and
- Mirage 2000-5.

All pilots had an extensive aeronautic background, with an average flying time of 2,490 hours (standard deviation of 1,080 hours).

Questionnaire answers were processed by content analysis to draw out major trends. Given the sample polled, a qualitative analysis was more relevant than a quantitative one. This sample is not representative of the crew population flying last generation aircraft from NATO countries. Furthermore, for strict statistical purposes, the specificities of each aircraft (combination of aerodynamic capacities, on-board systems and interfaces), as well as pilot experience should be taken into account.

2.3.1. Cognitive Constraints

Close combat with modern aircraft generates numerous cognitive constraints. Pilots mentioned both the constraints generated by aircraft capacities and those generated by systems capacities. For 65% of the pilots, these constraints are experienced as increased workload, but this feeling is not shared by all. This difference of opinion depends on what systems and interfaces are on-board, because they can make situation management more or less convenient. Analyzing the various cognitive constraints shows that:

- Time pressure is seen as the lowest constraint. This judgment seems strange, given the very short response time available to manage situations. In fact, responses are supposed to be so quick that time is not available for management purposes. Rather, responses must be reflexive. Thinking is considered a waste of time. The pilot "feels" rather than "understands" what is going on; assessing trends and reacting according to experience.

- Loss of information was rated a slightly higher constraint than time pressure, without being truly penalizing since it often has no consequence on the immediate time frame. The information lost usually involves non-priority issues. It is unusual to lose track of high priority items, since the pilot's attention is totally focused on them. However, when priority information is lost, situational awareness seriously deteriorates and consequences on performance can be far-reaching.

- The complexity of the information supplied by on-board systems or by outside communication media represents a severe constraint for crews. Information complexity raises the issue of human/machine relationships, and of the phrase "the right information at the right time in the right format." With today's systems, the crew has a better grasp of its environment. But the information provided has been pre-processed and is not always compatible with the crew's immediate mental representations. There is a gap between an equipment manufacturer's design rationale and the crew's logic of employment. This complexity is further compounded by the lack of transparency surrounding the way the data

were obtained and the processing applied to it. Weapons systems are becoming increasingly sophisticated and even though their implementation is facilitated by aids, using them presents a significant mental load for the crew.

- Information flows also constitute a strong constraint. These flows result from the increasing number of sensors and communication networks. They open up the pilot's "field of perception", but on the other hand also flood the aircrew with a mass of information difficult to handle given the lack of information management systems.

- The strongest constraint is the quick pace at which situation change. This is directly linked to the maneuverability of agile aircraft. Visual contact with other aircraft is an absolute priority to manage engagement and combat. Aircraft aerodynamic capabilities make it almost impossible to predict flight trajectories, and it becomes increasingly easy to suddenly have a turnaround in a given situation, and lose an advantage, which had previously been acquired. The extension of flight envelopes multiplies tactical opportunities and makes anticipation more and more difficult. Anything can happen faster than ever, and the situation changes rapidly. Agility helps achieve unexpected moves, which can surprise an opponent, but can also at any time lead to losing the upper hand. Combat is fought in a more demanding spatial and dynamic environment, requiring greater mental effort (often done subconsciously during combat) to observe, predict, fly and fight.

2.3.2. Cognitive and Physiological Constraints

The connection between cognitive and physiological constraints caused by load factors clearly appears in the answers to the questionnaire. This dimension is taken into account when assessing the mental effort required, since Gz acceleration has a direct impact on the pilot's mental resources. Acceleration impacts information processing at three levels:

- Part of the attention potential is mobilized by the mere activity of flying, to reach and maintain a high level load factor,

- Another large part of the attention potential is earmarked to off setting the physiological consequences of acceleration: applying anti-G maneuvers and having a proper body position in the cockpit,

- The field of vision is reduced because of the limitations in possible head movements and the physical consequences of acceleration on visual functions (restricted field of vision, greyout, etc.). Pilots only maintain central vision.

The crew is then forced to allocate the remaining resources to manage parameters essential to survival, to the detriment of weapons management, which inevitably becomes simplified.

Gy acceleration was not mentioned by pilots as penalizing in close combat situations.

2.3.3. Situational Awareness

Situational awareness is defined by pilots as having sufficient perception and understanding to be able to predict future changes occurring in the situation, from the information supplied by the outside, on-board systems and links connecting the aircraft with the outside. For pilots, situational awareness in a close combat situation involving modern aircraft is a major issue. In the survey, 78% of the 29 pilots surveyed said they had sometimes lost situational awareness during these flight phases.

The physiological and psychological constraints mentioned above influence the situational awareness developed by pilots. In addition to just having situational awareness, pilots also raise the question of having the right situational awareness. Is it necessary to have total situational awareness, or is partial awareness sometimes sufficient? The realities of air combat show that when engaging in combat, situational awareness needs to be as comprehensive as possible. However, once combat is engaged, the predictability of the situation changes and the time constraints, information flows, and lack of critical information (such as identification of external link targets) make it difficult if not impossible, for pilots to acquire comprehensive situational awareness. It can only be partial, and can range from high to low. The difficulty is then for the pilot to assess the relevance of this partial awareness to the situation, decide whether it is sufficient or not, and decide to continue the combat or stop. In practice, under specific situational awareness threshold, combat should be stopped, but in real life things are never this simple. This is a very important issue for pilots.

The questionnaire also tried to identify whether different components of situational awareness are easy or not to acquire and maintain in modern air combat. According to the pilots' answers, it seems that:

- Knowledge of the energy situation of modern agile friend or foe aircraft is more difficult to acquire and maintain than in older combat circumstances. Pilots explain this by referring to the frequent and rapid changes occurring

in the physical and tactical environment. It is no longer easy to assess and predict the speed, banking rate, altitude, and potential acceleration of enemy aircraft. In regards to the pilot's own aircraft, several factors contribute to this decreased perception of the aircraft's energy situation. For instance, the information displayed in the cockpit is often illegible or difficult to access. Also electronic flight control systems minimize the feeling and other feedback cues on the aerodynamic state that were available with older flight control systems.

- Identifying the envelope for weapon delivery and knowing the present and future position and trajectory of friend or foe aircraft are also more difficult to accomplish than in former combat situations. This opinion also shows that despite the increasing number and sophistication of on-board systems, the information supplied to pilots does not greatly contribute to enhancing situational awareness in highly complex combat environments. The pilots did not directly mention root causes. However, one reason may be that the nature of the information displayed and/or the way it is displayed does not meet pilots' cognitive requirements.

- On future aircraft, pilots do not envisage to acquire good situational awareness without high level of automation for support systems and man-machine interfaces. This feeling reflects the constant efforts made by designers. A great number of on-board systems are now perceived as being essential and crucial to achieve the mission. However, pilots mentioned the functional coherence between systems functions, aids, aircraft properties and interfaces do not always exist. Future aircraft design has to be users' need-centered and not a technology "patchwork".

2.3.4. Consequences on Performance

Performance is the result of pilot behavior. It involves tactical aspects (shooting the enemy or flying away) as well as mission safety aspects (managing separation with other aircraft, managing aircraft movements in relation to ground or to ground-air threats). The complexity of close combat makes the simultaneous and comprehensive management of all these goals difficult. Pilots have to prioritize issues, and set a number of activities aside. Another solution is to simplify operations by lowering control precision, and only using familiar routines or a portion of the functions or capabilities of each system.

The higher the constraint, the more the pilot will operate sequentially, processing one single goal after another. Goal prioritization then becomes a key element in mission success. Of course in the background, the pilot must also stay on the lookout to detect any alarm signal, which could challenge the priority list established. The difficulties entailed by goal management are especially noticeable when managing the energy situation of the aircraft, acquiring and maintaining contact with enemy aircraft, and using the weapon systems. Yet, the closer the target, the more dynamic and unpredictable the situation becomes, ever decreasing the time available to perceive, understand, and act. Conversely, a pilot must be able to use the aircraft's movement potential and systems changes to surprise the enemy. Tactics are now less predictable than before and their implementation is increasingly reactive.

The impact for pilots stems from the level the pilot is in control over the situation. The pilot is in control when there is enough capacity to anticipate situation developments. Loss of control results in a reactive behavior. The pilot no longer controls events, but becomes subject to them, and is always trying to catch up with the aircraft. In modern close combat, tactical patterns are more numerous and more diverse, given the increased options allowed by aircraft maneuverability and by weapons system performance. The pilot cannot anticipate all possible tactics, but even if this was possible, it would require an in-depth knowledge of the possibilities offered by enemy aircraft and systems. Because of this, some pilots say that although modern aircraft have a higher performance level than older ones for close combat, they require the adoption of an increasingly opportunistic behavior since it is very difficult to anticipate situation developments and the pilot is less and less frequently in control of the situation.

The questionnaire answers also stated that agility cannot only be envisaged in terms of aircraft maneuvering capacities. In addition to airframe agility, systems and weapons agility must also be taken into account. Agility is the capacity to minimize the time required to acquire and shoot an enemy and systems and weapons play a role as important as the airframe itself. The agile aircraft must be a coherent entity, within which the "intellectual" agility of the pilot is integrated.

A question on the possibility of adding a second crewmember (pilot or Weapon System Officer) to help relieve situation complexity was included in the questionnaire. Pilots had different opinions on this, since:

- 52% believed a second crewmember would not improve performance, and could even deteriorate it. They argued that the time constraint involved in the situation does not leave enough time for an effective dialogue. Perception-action cycles are too short to allow for real coordination.

- 38% believed this could help, allowing task sharing and providing relief in highly strained psychological situations (four eyes are better than two). The cockpit should however then be designed to accommodate task sharing. Collective work rules also need to be developed to offer the best synergy possible. Some pilots see a second crewmember as a useful operator, not necessarily in combat situations, but in order to ensure aircraft survivability, should the pilot lose situational awareness.

- Finally, 10% had mixed feelings; they believed a second crewmember would add effectiveness, but remained very doubtful as to the feasibility of such a cockpit and on the definition of really effective collective work rules.

2.3.5. Pilot Aid Systems

Close combat with agile aircraft is not possible without aid systems. The physical and cognitive constraints described by pilots are so demanding that the pilot alone will find it difficult to handle the complexity of the situations encountered. Modern aircraft are equipped with a great number of different systems designed to aid pilots. As a rule, pilots are quite satisfied with them. The small number of criticisms related more to the systems interface than functionalities. When pilots were asked what additional aids they would like to have, they mention technical systems. However, the main point raised in their answers is that it is important to ensure that the functionality and operability of the systems are complementary, with efficient, pilot-centered interfaces. However this is not easy to achieve, given the extent to which technology and human factors research have addressed human performance in complex systems. The shortcomings mentioned by pilots involved limitations in these two areas, which will obviously require further research works.

Aids on board modern aircraft (see also Ergonomics Chapter) can be grouped into two categories:

- Aids providing relief for part of the pilot's activity, even if final control is required,
- Aids helping the pilot perceive and understand the situation to make better decisions and to carry out programmed actions.

Among the aids providing relief in various pilot activities, are the following:

- Navigation and flying aids,
- Protection systems management,
- Electric Flight Control System: they free the pilot from various flying constraints, but must be "care free" to be optimum. "Care free handling" system is a system that integrates flight and propulsion control, and enables a limited number of controls (stick and throttle) to be used to maneuver the aircraft inside the whole flight envelope and takes care automatically of the aircraft limitations.

Among the aids enhancing information processing:

- Improved sensor performance: radar, optronics, Identification Friend or Foe, and low ground clearance alarm systems all provide improved information on the environment.
- Displays: HMD/HMS, 3-D audio, wide field-of-view HUD. The purpose of these displays is to minimize pilot head movement for retrieving information during combat phases, and help maintain watch outside of the cockpit (acquiring visual items, and never losing track of them).
- Voice or data transmission communication media to obtain information known by the system or by people outside the cockpit.
- Information presentation more in line with the pilots' cognitive needs: analog rather than digital displays, presentation of aircraft energy state, integration of information from various sources on a same medium, and preliminary processing of data displaying safe and dangerous zones.
- HOTAS concept for facilitating control of multiple systems while reducing reaction time and maintaining the hands on the throttle and on the stick.
- Direct voice input for hands-free control.

2.3.6. Training and Practice

The last part of the questionnaire was aimed at assessing two items:

- Physiological and psychological abilities required by aircrew to fly modern aircraft in situations of close combat,
- Specific training developed for these crewmembers.

According to the pilots' answers, it seems that a good physical condition is essential. This fitness must be supplemented by regular acceleration training in centrifuges and in real life situations.

The psychological qualities of competent combat aircrew listed were: aggressiveness, willpower, enthusiasm, ingenuity and cunning. Pilots mentioned various cognitive abilities: good spatial capacities, excellent eye-to-hand coordination, quick reaction time, and efficient information management. The comments also stressed that pilots need to be reactive, flexible, accurate, cautious (knowing importance of verification), and able to make decisions under stress.

Beyond these abilities, strictness and professionalism were considered as the two essential qualities of a good fighter pilot. These two qualities help pilots know their aircraft and its systems inside out, as well as enemy aircraft. Knowing all these automated and computerized systems is extremely time-consuming given the great number of available functions, and implementation options, and sometimes the difficulty encountered by the pilots to totally understand the functioning of these systems. The qualities of a fighter pilot must be developed by training, in simulators as well as in flight. "Full-scale" mission simulators are essential to acquire this know-how, but cannot replace practice in real life conditions. This practice must be regular and frequent, because the abilities developed are complex and require permanent reinforcement. The final goal of this training and practice is to make pilot's behavior automatic so they can react as quickly as possible any given situation and its constraints.

2.4. CONCLUSION

These 2 surveys helped draw a relatively comprehensive picture of the problems raised by close combat with modern aircraft. They offer various opportunities for a further analysis of the "human factors" consequences of close combat with agile aircraft. The rest of this report addresses these opportunities.

This page has been deliberately left blank



Page intentionnellement blanche

3. AGILITY: DEFINITIONS, BASIC CONCEPTS, AND HISTORY

Patrick Le Blaye

ONERA
Systems Control and Flight Dynamics Department (DCSD)
Base Aérienne 701, 13 661 Salon Air, FRANCE
leblaye@onera.fr

3.1 SUMMARY

The purpose of this presentation is to provide some engineering basis of the concept of agility.

The definition of agility has evolved across recent aviation history, from the well known area of airframe agility to a global concept of operational agility. Some historical definitions are given and the underlying concepts are explained.

The working group 27 has adopted the consensus definitions initially proposed by the working group 19 of the Flight Mechanics Panel of AGARD, in order to support its discussion on the Human consequences of aircraft agility.

The concept of agility can be applied to each component of the combat system (airframe, systems, weapons). Agility factors specific to each component are briefly examined, and some orders of magnitude are given, concerning present and future weapon systems performances, which may have particular consequences on the human in flight.

The concept of operational agility is introduced; this concept integrates the role of the human pilot. This paper is concluded with some perspectives for potential areas of preoccupation relative to human implications of the future combat scenarios and information environment.

3.2 INTRODUCTION

Recent aircraft prototypes such as the X-31 or Su-35 have demonstrated impressive flying capabilities and astonishing maneuvers, which first come to mind when one speak of "agility". The technical feasibility of such agile airframe and its tactical utility under particular combat conditions is now widely acknowledged. Future aircraft will probably integrate some technologies directly derived from this prototypes, such as thrust vectoring and flight controls integrating new devices. Those technologies result in an extension of the flight envelope and possible maneuvers ; they may pose new requirements on the pilot.

Less spectacular but probably much more influent are the emerging technologies (calculation power, sensors, datalinks,...) and the new tactical environment (multi forces, multi role, multi targets,...) which contribute or push to enhance the agility of each component - airframe, but also avionics and weapons - of the combat system used by the human pilot.

This high level of agility of each component is obviously desirable and it should result in an increase of the global agility of the combat system, which require special attention from the engineers. Moreover, global agility results in an always increasing information flow made available to the pilot and which has to be efficiently used in order to fulfill the mission.

3.3 HISTORICAL DEFINITIONS

Generally speaking, agility is defined as the quick moving of a body or of the mind.

The historical background reveals an evolution of the concept of agility or similar concepts applied to highly maneuverable aircraft. This evolution is of course linked with the progress of aircraft technologies and with the consecutive extension of flying capabilities.

3.3.1 Supermaneuverability and Post Stall Flight

Before agility, supermaneuverability was first defined, as the "ability to fly in the post-stall regime".

The post stall regime is the domain of flight at high angles of attack.

In the conventional regime, angle of attack is limited to low values, where lift increase almost proportionally with the angle of attack.

In the post stall regime, lift no longer increases but decreases with the angle of attack (Figure 1). So, the aircraft trajectory may go down while the aircraft nose is high, and the actual aircraft trajectory may become difficult to perceive for the pilot.

Also, aircraft capable of controlled flight at high angles of attack usually have very efficient control devices and demonstrate high angular rates, which make rapid changes of the flight trajectory possible.

These facts are illustrated in an other definition of supermaneuverability, which "refers to the unusual flight trajectories presently investigated by high performance fighter aircraft" [1].

Flying at high angles of attack raises difficult problems in term of aerodynamic behavior, propulsion and flight controls. It requires a powerful and sophisticated integrated control system so that the aircraft can be effectively flown by a human pilot. The progress in computer power was a sine qua non for opening this new domain of controlled flight.

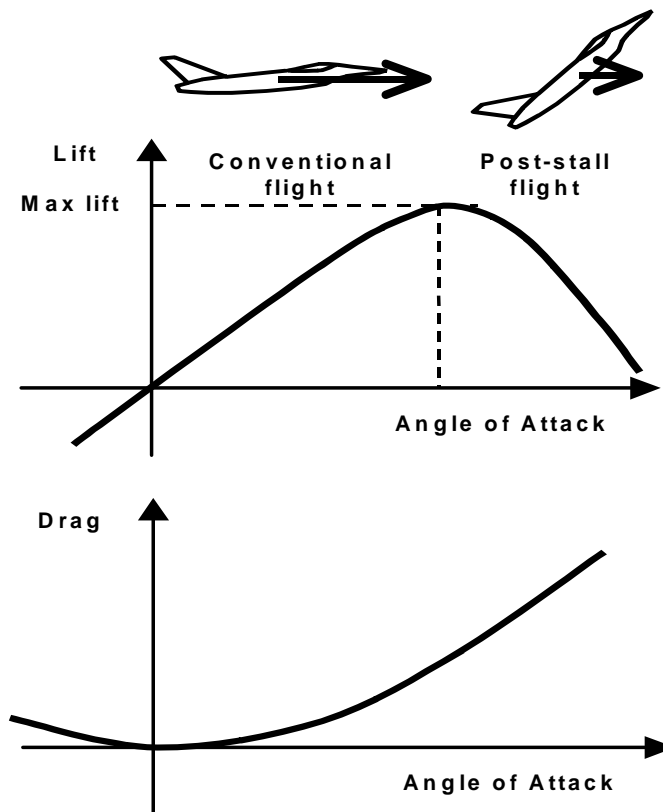

Figure 1: Conventional and post-stall flight.

The post stall regime is necessary synonymous of low speed flight ; this fact makes its practical utility somewhat questionable and probably limited to particular combat conditions, such as one-versus-one closed-in combat.

However, historically, the research necessary to extend the flight domain of some prototypes to the post stall regime has widely contributed to the progress in the robustness and reliability of the flight control systems installed on most modern aircraft and in their handling qualities at low speed, which is needed also in conventional critical flight phases such as take off and landing.

3.3.2 Agility, Super Agility and Hyper Agility

The notion of agility appears with the generalization of naturally unstable flown-by-wire aircraft and the development of thrust vectored prototypes. Those aircraft exhibit high maneuverability and turn rates even at high angles of attack and an extended flight envelope, sometimes including the post stall regime.

Many similar definitions exist and are now well accepted to define the airframe agility [2]:

"Ability to shift from one maneuver to the other" (Col. Boyd, 1986)
 "Time rate of change of the aircraft velocity vector" (W.B. Herbst, 1988).

Next, a more general definition emphasize the shift of the concept of agility towards global agility, including the role of each element of the system into its efficiency:

"Ability of the entire weapon system to minimize the time delays between target acquisition and target destruction"
 (A.M. Skow, 1989).

This recent concept of global agility was used in various studies on the practical impacts of agility, sometimes with slightly different denominations: weapon system agility, full envelope agility, practical agility, operational agility.

For instance, a parametrical study on the tactical utility of new technologies such as post stall flight, enhanced radar coverage and agile missiles addressed the full envelope agility; its results emphasize the need for the balance and proper integration of the various components of the weapon system, including aircraft, armament, avionics and pilot [3].

Only a few references exist for the denominations of super agility or hyper agility [4]. These denominations could be understood as either augmented agility or supermaneuverability (post stall) plus agility, but it seems that they may lead to some confusion and that there is no need for new terms, unless they relate to a particular new technology or capability.

3.4 RECENT DEFINITIONS

In recent years, the Working Group 19 of the Flight Mechanics Panel of AGARD [5] made a considerable effort to synthesize the various and sometimes differing viewpoints on the topic of agility.

This group eventually identified several possible aspects of agility and provided some consensus definitions as follow:

Airframe Agility: the physical properties of the aircraft which relate to its ability to change, rapidly and precisely its flight path vector or pointing axis and to its ease of completing that change.

Systems Agility: the ability to rapidly change mission functions of the individual systems which provide the pilot with his tactical awareness and his ability to direct and launch weapons in response to and to alter the environment in which he is operating.

Weapons Agility: ability to engage rapidly characteristics of the weapons and its associated onboard systems in response to hostile intent or counter measures.

Transient Agility is a continuously defined property reflecting the instantaneous state of the system under consideration.
Operational Agility: the ability to adapt and respond rapidly and precisely, with safety and poise, to maximize mission effectiveness.

The quickness and precision are critical elements of all these definitions.

The concept of Operational Agility was established with the essential intent to provide definitions and metrics appropriate to capture the role of the component parts of the weapon system and their interaction, as the main contributor to the global effectiveness of a complex aircraft design.

The Working Group 19 also covers the pilot-vehicle interface and finally give some recommendations, two of whom are directly related to the human consequences of agility:

- Establish the Influences on Awareness of High Rate and Acceleration Maneuvers.
- Establish the Influence of Prolonged Exposure to Sustained ‘g’ at Moderate Levels.

In the following chapters, we will briefly examine the concepts of agility relative to each component of the system (airframe, systems, weapons) and give some orders of magnitude of nowadays and future weapon systems performances, which may have particular consequences on the human in flight. We will then examine the concept of operational agility and conclude with some perspectives for potential areas of preoccupation relative to the future combat scenarios and tactical environment.

3.5 COMPONENTS AGILITY

3.5.1 Airframe Agility

3.5.1.1 Two Complementary Considerations

Airframe agility relates to its ability to change, rapidly and precisely its flight path vector or pointing axis and to its ease of completing that change.

This definition covers two complementary considerations:

- maneuverability, the ability to change magnitude and direction of the velocity vector, and
- controllability, the ability to change the pointing axis through rotation about the center of gravity, independent to the flight path vector (Figure 2).

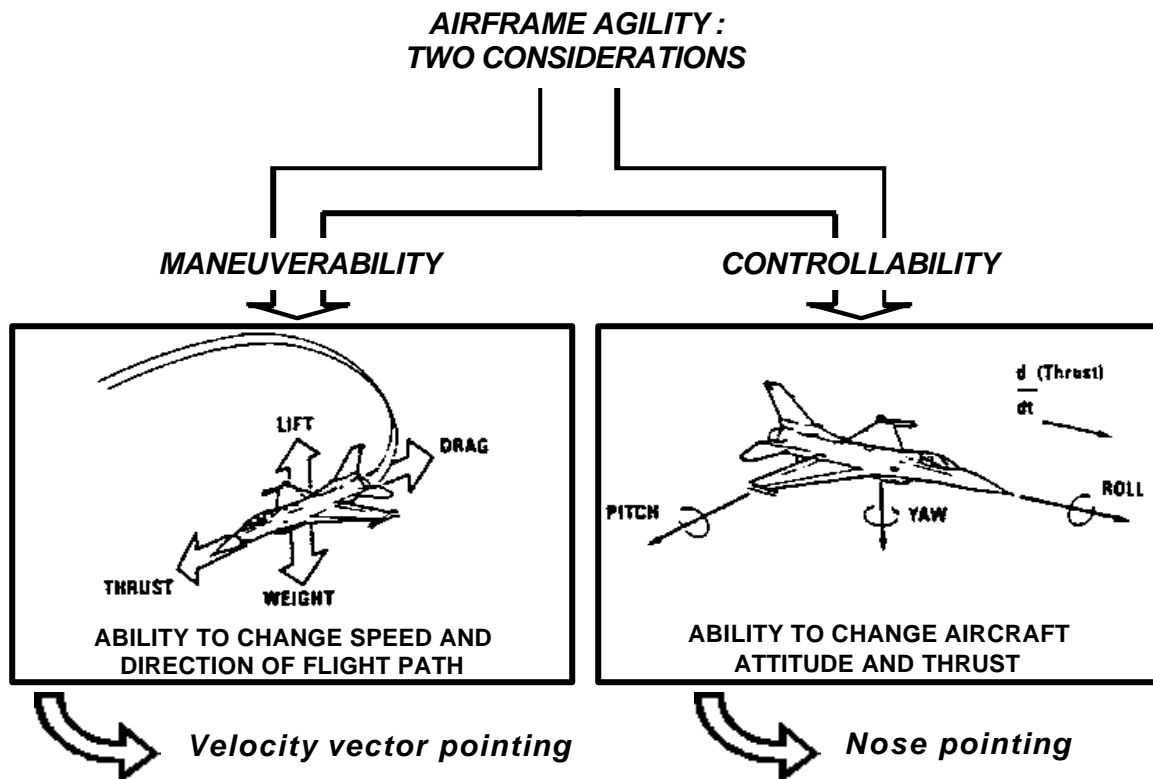

Figure 2: Airframe agility: maneuverability and controllability.

In the common sense, those considerations are sometimes conflicting and, indeed, they reveal that agility is the result of a compromise in the aircraft design: on one hand, it is desirable for the aircraft to be able of high peak velocities and turn rates, i.e. to have a high maneuverability, and in the same time it is highly desirable to be able to precisely control those parameters, which is obviously easier to obtain when the peak values are limited.

As such, airframe agility relates closely to, and may be regarded as an extension to, flying qualities. The considerations above are related to the distinction classically made in flight dynamics between, respectively, the study of aircraft performance and the study of handling qualities.

The airframe agility may or not include the aircraft ability to fly and to maneuver at high angles of attack, also described as the post stall flight region, which give rise to new problems to the designer (aerodynamic stall, propulsion ignition, non linear and non stationary behavior, unstable configuration, control of the possible departure).

This ability to fly at very high angles of attack may also pose some specific problems to the pilot, for instance to perceive what is the actual flight path of the aircraft. This problem is partially due to the technical difficulty to present the direction of the velocity vector on a display with a limited field of view. Some possible future solutions will be covered in the pilot-vehicle interface chapter of this lecture.

This problem is also clearly due to a necessary change into the basic flying habits of ordinary pilots. On light aircraft, the primary flight parameter is the aircraft body pitch angle; it is visually controlled and the consequence of any change on the flight path is also visually controlled. On aircraft equipped with a head up display and an inertial navigation unit, the direction of the velocity vector is usually displayed. It is used for instance when achieving a precise head up landing. Pilots usually get used quite easily to this new way of piloting, there is no deep conflict between body and velocity axis because the angular difference are still limited. On an agile aircraft flying at very high angle of attack, the body axis and the velocity axis may get completely decoupled, resulting in a complete difference between the perceived aircraft attitude and the actual path, which are no longer linked by the traditional flight equations.

Some similar problem may occur as soon as a technology is introduced that radically extend the possible solutions available for the pilot to achieve a given goal. This class of problem will be addressed in the chapters of this lecture dealing with psychological aspects, and selection and training.

3.5.1.2 Longitudinal, Torsional and Axial Agility

In order to derive human consequences of airframe agility, it may be useful to consider separately some of the main components of this agility. Different definitions and reference systems are available to achieve this goal. They're introduced below.

Three axis are frequently used to describe the agility relative to the velocity vector rotation/change into the body axis:

- Longitudinal agility: rate of change of the angle of attack, up and down (Figure 3).
- Torsional agility: velocity vector roll rate (Figure 4).
- Axial agility: rate of change of the velocity.

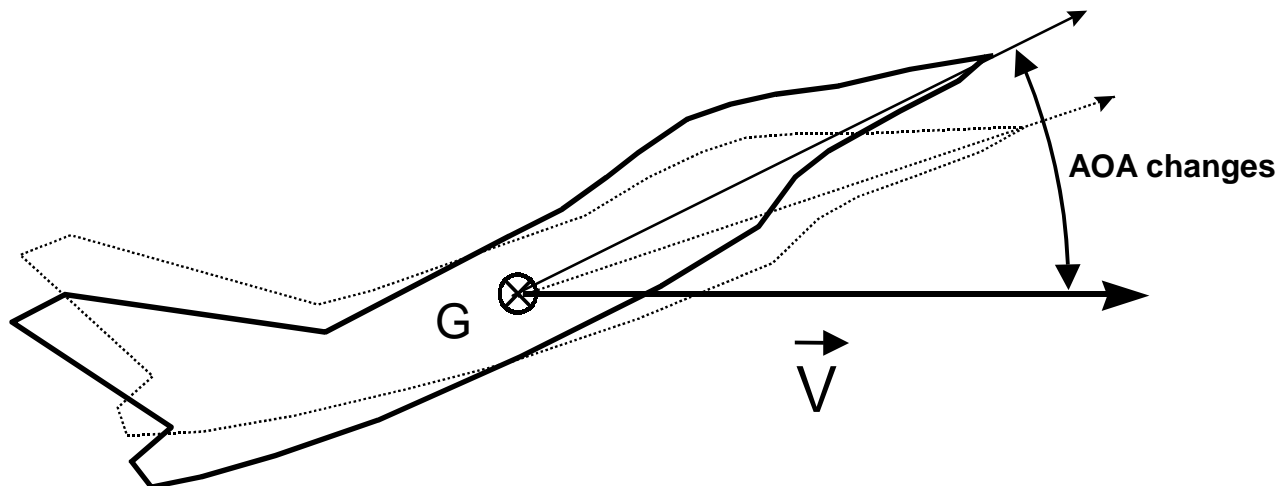

Figure 3: Longitudinal agility.

Longitudinal agility (pitch up) is related with the ability to rapidly point the nose of the aircraft. This ability is necessary in air combat as it allows to align and shoot a target, once an appropriate relative position has been acquired. In the conventional regime, an increase of the angle of attack means a reduction of speed and an increase of the load factor. The rate of change of the load factor is called the G onset. G onset up to 15 G/sec might be obtained on modern fighters. The maximum G onset level is a critical parameter of a possible pilot's loss of consciousness, together with the duration of the exposure to the maximum G level.

Longitudinal agility (pitch down) is linked with the ability to quickly recover speed, for instance after a shooting maneuver has been achieved. This ability is absolutely necessary if high angle of attacks are to be used, because the aircraft at low speed is very vulnerable.

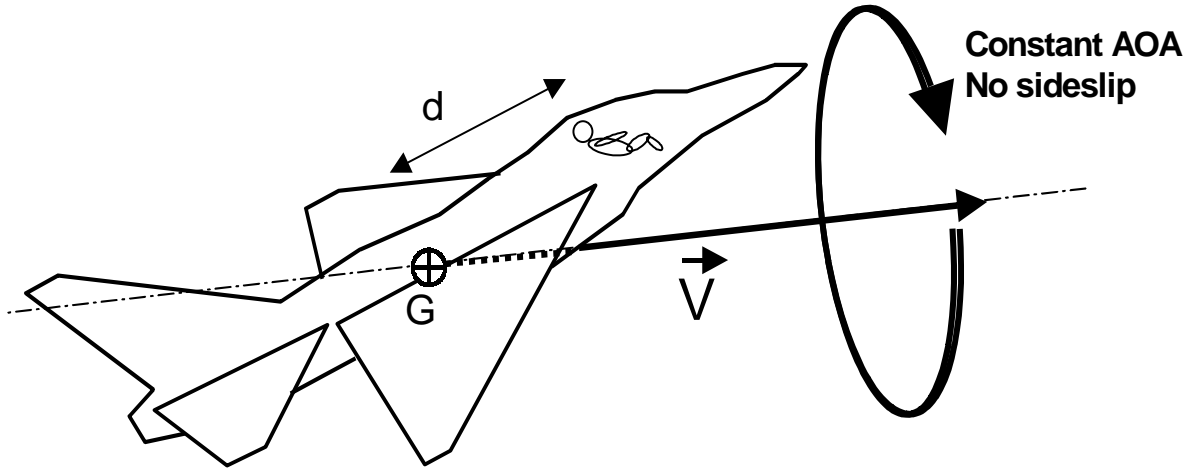

Figure 4: Torsional agility.

Torsional agility is relative to the roll rate around the velocity vector, with a constant angle of attack and with zero sideslip. The roll rate around the velocity vector is considered rather than the roll rate around the body axis. At small angles of attack, those rates are almost identical, but at high angles of attack, the control of the velocity vector roll rate allows a better decoupling of the aircraft attitude with the aircraft flight path. The velocity vector roll rate results from a combination of the body axis roll and yaw rates, which is achieved by the flight control system. The side slip angle is usually maintained at the value of zero, in order to reduce the aerodynamic drag. When the angle of attack is high, the velocity vector roll is perceived as a yaw by the pilot. Any change in the velocity vector roll rate results in a lateral load factor applied to the pilot. The value of this lateral load factor depends on the distance between the aircraft center of gravity and the location of the pilot's seat.

Axial agility is necessary in order to quickly accelerate, for instance once a target has been detected and has to be intercepted, or once a low speed combat maneuver has been achieved. It is obviously primary linked to the maximum thrust available and also to the engine response delay, from the time the throttle is pushed forward to the time the thrust actually reached the corresponding value. This delay depends on the engine regulation and inertia. Also, the tolerance of the engine to abrupt changes of the throttle position is certainly an important characteristic of axial agility.

Nowadays, the common design of aircraft control laws aims to give the pilot the direct control of those three components independently.

It has to be noted that each of these three components of agility is not directly linked with one particular component of the acceleration vector (noted G_x , G_y , G_z in the aerodynamic reference system). The relationship between one control component and the actual acceleration response depends on the flight control system. At a first glance, one can only give some general rules: the longitudinal command is usually the load factor/ G_z acceleration at high speed and the angle of attack at low speed (below corner speed); the lateral command is the velocity vector roll rate, which results in a mix of G_y and G_z accelerations; the engine command is primarily linked with G_x acceleration with a G_z component at high angles of attack or when thrust vectoring is available.

The effects of each acceleration component into the pilot's body axis of reference obviously depend on the position and on the inclination of his/her seat.

3.5.1.3 Nose Pointing Versus Velocity Vector Pointing

Another distinction among the components of the airframe agility can also be introduced with some benefit in order to assess the practical influence of agility:

- the nose pointing agility is the primary effect of a change of the aerodynamics or thrust controls, and
- the velocity vector agility is a secondary effect of the nose pointing agility, chronologically speaking.

This distinction is particularly appropriate when evaluating the influence of agility on the weapons employment. When firing the aircraft gun, the pilot has to point the aircraft nose towards the target : the gun firing opportunities are obviously related to the nose pointing agility. When they are launched at a high -limited- angle of attack, conventional missiles “fall into the wind” because of their natural stability. So, the pilot trying to launch a conventional missile has to orient the velocity vector to the target otherwise the missile may break lock after launch : the missile launch opportunity are first dependent on the velocity vector agility.

These considerations are of course directly linked with the capability of the weapons. For instance, future missiles may be launched under adverse conditions (high AOA) or unlocked, which may modify the requirement to orient the aircraft or the velocity vector before launch.

3.5.1.4 Technologies for Airframe Agility

Among the enabling technologies for airframe agility, the following are of primary importance:

- Aerodynamic design (configuration, control surfaces),
- Propulsion design (air intakes, engine tolerance),
- Thrust vectoring (pitch only or pitch and yaw),
- High Thrust to Weight ratio, key characteristic for the aircraft capacity to quickly recover its energy,
- Flight Control laws and systems (fly by wire).

Now almost in operation, the thrust vectoring allows a substantial increase of the maximum pitch up and pitch down rate, as shown by the flight test results of the YF-22 aircraft (Figure 5).

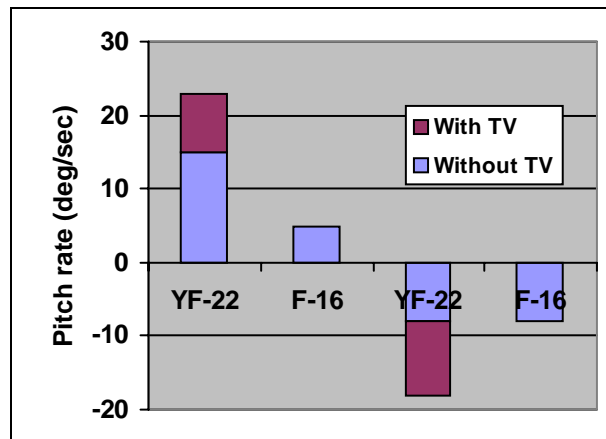

Figure 5: Maximum pitch up, pitch down of the YF-22 aircraft compared with F-16 [6].

The thrust vectoring also contributes to an increase of the maximum roll rate (Figure 6). This is due to the fact that thrust vectoring, even if pitch only, allows a substantial relaxation of the constraints over the aerodynamic control surfaces, which can then be used to control the roll rate, while the pitch attitude is controlled by thrust vectoring.

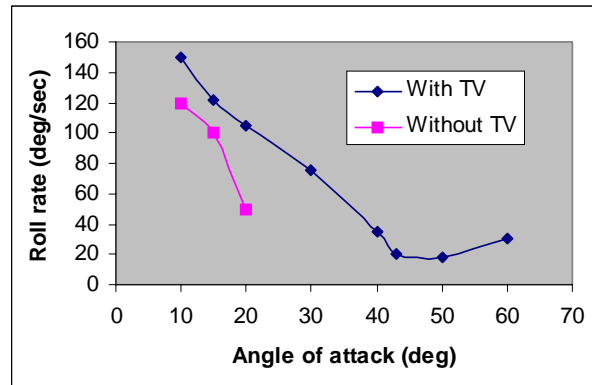

Figure 6: Maximum roll rates of the YF-22 aircraft, with and without thrust vectoring [6].

Thrust vectoring may be available on most future aircraft as a baseline or as an option. Studies and flight test are on the way for most programs currently under development (JAS 39 Gripen, F-22, JSF, Su-37 export).

In fact, the thrust vectoring technology has two main possible applications:

- improve the handling qualities and expand the flight envelope (high agility, post stall flight, STOL),
- or exploit this new control device to reduce traditional control surfaces (canards and tail) and thus, reduce drag and improve stealth.

One can suppose that a key concern for the aircraft manufacturers is to determine the best possible trade-off between performance/agility and stealth.

3.5.1.5 Controls Implications of Airframe Agility

The aircraft controls consist of the pilot's inceptors primarily used to handle the aircraft. They are primarily related to the aircraft flying qualities.

An high airframe agility may be achieved by adequate aerodynamic design and by various devices, such as extra aerodynamic control surfaces, forebody vortex control, pitch-only or pitch-yaw thrust vectoring. The number of elementary controls devices, the dynamics required to control the aircraft in the unconventional flight regime (high angles of attack), the non-linear behavior of the aircraft in those conditions, the necessary adjustments of the engine air intakes, together with the natural instability of the airframe necessary to achieve high maneuverability, are all numerous factors which require a sophisticated and integrated flight control system.

3.5.1.6 Towards a Carefree Handling System

Whatever the means used to obtain the airframe agility, the philosophy underlying the design of the flight control system may differ from one country or from one aircraft manufacturer to the other.

Some aircraft provide good examples of an original control philosophy:

- Thrust vectoring independent control (Harrier, Su-37 TV). In aircraft such as the Harrier, the ability to independently vector thrust was designed primarily to achieve vertical or short take-off and landing performance (STOL). Subsequently, the ability to vector in forward flight was also demonstrated as a possible combat technique which provides rapid deceleration and extra lift [7]. However, the requirements for post stall maneuverability are quite different: pitch and yaw axis moments generation is then required, together with rapid response rates which make an integrated flight/propulsion system mandatory. The ability to engage and disengage thrust vectoring may be required in particular situations, such as degraded flight modes, but pilots are probably most likely to benefit from integrated, rather than independent, control when it is engaged. This is demonstrated for instance by the research programs conducted on the basis of the Harrier aircraft experience, involving integrated flight control of thrust vectored aircraft [8].

- Departure-tolerant aerodynamic design (MiG-29, Su-35). The preferred philosophy among these particular designs is to allow the pilot to fly in the post-stall region while being able to recover from the spin, rather than to build limiters into the flight control system [9]. The intent is to be able to use the entire envelope in combat and to teach the pilot how to recover from unstable situations (possibly with the help of an auto recovery system, as the panic button existing on the MiG-29 aircraft).

Having considered those particular designs, a general agreement is now that a system integrating flight and propulsion control is likely to bring substantial benefits in terms of ease of use of the aircraft and also in terms of safety and mission effectiveness.

Such a carefree handling system enables a limited number of controls (stick and throttle) to be used to maneuver the aircraft inside the whole flight envelope and it takes care automatically of the aircraft limitations.

For instance, once selected, operation of thrust vectoring is transparent with the flight control system dividing the required controls deflections between the thrust vectoring and conventional control surfaces. The system may also limit the stick inputs so that the load factor never exceeds the aircraft structural limits, given its current configuration.

The carefree system may improve flight safety, as it makes it possible to avoid aircraft departure and loss of control in most flight conditions.

Safety and flying accuracy can be further improved by implementation of advanced functions such as:

- automatic recovery from unusual situations,
- ground proximity warning,
- obstacle and collision avoidance,
- exit gate and aided post stall termination,
- optimized maneuvers, e.g. for energy recovery.

Carefree handling makes it easier for the novice pilot to fly the aircraft. This is now a key advantage as the formation and training flight hours are reduced. Also, a side effect of the carefree control system is that the aircraft can be flown more aggressively, without any limitations on the control stick input.

On the other hand, expert pilots have a tendency to find it frustrating because their flying proficiency is not recognized as it used to be. Anyway, the pilot job in the future will obviously comprise more management and decision tasks than basic flying.

As the basic flying workload is reduced, the pilot can better concentrate on the tactical decisions and actions. Spatial orientation and situation awareness are also supported by carefree handling, as less attention is required to the primary flight information displays.

3.5.1.7 Lessons Learned from the X-31 Experience

The X-31 program provides a good example of a carefree integrated flight control system : the design goal was to allow controlled flight and carefree maneuvering at and beyond stall boundary, without any additional workload in the post stall region [10].

This is achieved by use of three thrust-vector vanes, plus four trailing edges flaps and an all-moving canard. These control effectors were all integrated into an advanced flight control system.

The control law was designed to control the aircraft in the flight path axis system:

- load factor command up to 30 degrees AOA and angle of attack command when in post stall (PST), i.e. above 30 degrees AOA,
- velocity vector roll rate command (with zero sideslip),
- sideslip command (below 40 degrees AOA).

The handling quality requirements consist of high pitch and velocity vector rates (pitch rate up to 25 degrees/sec and velocity vector roll rate between 30 and 50 degrees/sec in PST, i.e. for an angle of attack ranging from 30 to 70 degrees) plus precise fine tracking for gun aiming.

Those objectives can be quite conflicting because of the large angle of attack domain; they require a careful design of the control system and gains. For instance, the longitudinal stick sensitivity in the X-31 was so high that it was possible to command high AOA even when you really did not need it. This was corrected by the addition of a pilot selectable AOA limiter into the flight control software [11].

Also, a problem appeared during the flight trials of the X-31, with the pilots hitting their legs with the stick when commanding high roll rates at high AOA. A scaled lateral stick command was implemented into the software to solve the problem.

Some possible alternatives may be to use special command devices or systems : long stick in use in the Russian aircraft, balance of the force-feel system design [12], multi-mode control laws depending on the task/phase of flight...

The X-31 control laws were designed to achieve zero sideslip maneuvers in PST. This design implies little G_y at the aircraft center of gravity and thus, small lateral accelerations are imposed to the pilot. Also, the normal load factor remains relatively low, because of the low airspeed in the PST domain. As the X-31 is a relatively slow aircraft when compared to modern fighters, high levels of $+G_z$ may be attained only during the transient phase of increase of angle of attack, during a short time duration. Some transition between G_z and G_x also exist when entering PST, but they were not perceived as painful nor disorientating, as the aircraft quickly slowed down and the acceleration remained at moderate levels.

One possible problem of carefree handling may be the lack of sensory cues. Most of the conventional aircraft have some characteristics such as noise, buffet or wing rock which inform the pilot where his current status point is into the flight envelope. In the X-31, the sensory cues (buffet and stick force) are almost the same at 70 degrees as they are at 12 degrees AOA. This led most pilots to ask for a tone to provide them with AOA cueing. Some similar difficulties may exist with other key flight parameters (side slip angle, heading, flight path angle, speed and energy), especially under low visibility conditions. The problem may be more acute as airframe agility and post stall flight relate to parameters which are not primarily monitored under conventional conditions ; special displays and a special training may be required for the pilot to monitor those parameters.

The various unpredicted obstacles discovered and eventually solved during the envelope expansion of the X-31 program suggest that the development of a totally carefree handling system is still questionable, because of the lack of theoretical methods to demonstrate the complete robustness of the handling system, especially under non conventional flight conditions. The only solution, currently applied when expanding the flight envelope of a new aircraft is to proceed with extensive flight tests, which are designed to be as exhaustive as possible given the program cost and time constraints.

3.5.1.8 Agility Metrics

The tools and methodologies currently used in the evaluation of handling qualities provide a large panel of solutions and viewpoints for the evaluation of the practical usability of the airframe agility.

The most easily usable metrics of airframe agility consist of the peak values of some key parameters, such as turn rates, angular rates, accelerations, instantaneous and sustained load factors.

For instance, the turn rate versus Mach number diagram (Figure 7) gives a good picture of the aircraft maneuverability envelope.

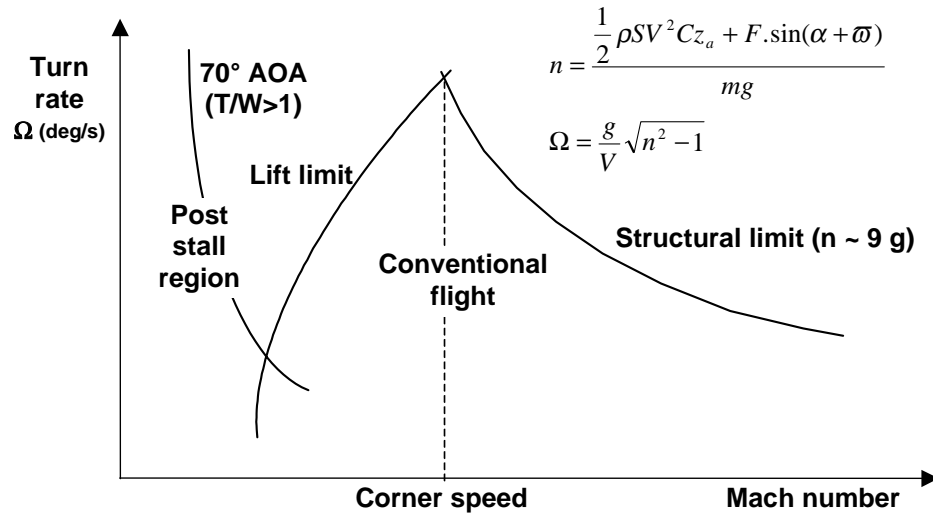

Figure 7: The turn rate diagram of a supermaneuverable aircraft.

Some typical orders of magnitude of these kind of parameters for existing and future fighter aircraft can be found in the literature [5, 6, 13, 14, 15].

However, the peak values are not sufficient for a precise analysis of the actual aircraft agility, as they give no information on the dynamics nor on the controllability of the aircraft.

So far, even though relationships between handling and flying qualities are already well-known for conventional aircraft and are subject to standard requirements (MIL-STD-1797 or ADS33), possible conflicts between flying qualities and performance have to be addressed at the design stage when high levels of airframe agility are to be achieved and operationally used [16].

The evaluation may address the following technical aspects : stationary and dynamic behavior of the aircraft under various flight conditions and configurations, ability and ease to perform particular tasks and maneuvers (gross or fine tracking, capture).

The available evaluation tools include numerical and man-in-the-loop simulation, and dedicated pilot's rating, such as the well known Cooper Harper rating scale which has often been adapted to capture the effects of particular features on pilot's control or workload.

The ability to fly at high angle of attack may also require some specific metrics and criteria, as it opens a new flight domain. Existing metrics have been extended for that purpose and new ones have been proposed [5, 16].

In an attempt to better capture the influence of the airframe agility on the combat effectiveness, some experimental metrics, pilot-centered or mission-oriented, have also been developed.

For instance, the Tamrat's combat cycle time is a measure of the total time duration of a typical combat, described as a cycle of state changes in the Mach number versus turn rate diagram [18]. It has been applied to aircraft capable of flight at high angles of attack and it is particularly useful to assess the aircraft ability to recover its energy after using a post stall maneuver (Figure 8).

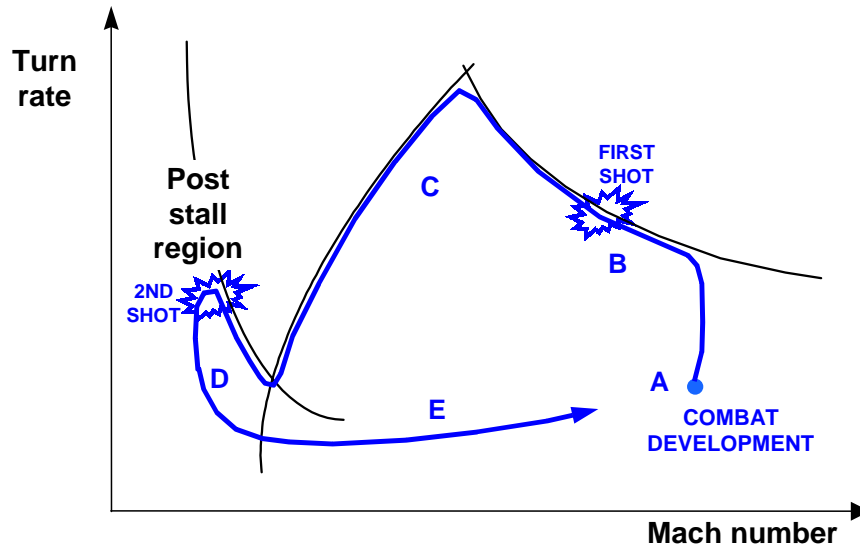

Figure 8: A typical combat development in the Mach number / turn rate diagram.

This concept of combat cycle is a useful viewpoint to better understand the cyclic nature of the physical constraints posed on the pilot during an actual fight:

- The combat cycle usually starts at the highest possible level of energy, which means high speed (supersonic) and high altitude, which are acquired as soon as the target is detected. The choice of this starting point (A) depends on the pilot's orders and experience, given numerous factors such as his role in the mission, the type of the target and the environmental conditions. A first shot may be decided at long range, weapons permitting.
- The combat cycle is first composed of one (or several) turns, from level flight at one gee and high speed to the maximum structural or sustainable load factor (B). The aim of this turn is to reach a favorable position relative to the target. It is a pre requisite of any modern engagement. During this turn, the pilot is submitted to sustained load factor at moderate to high level. The duration of this turn in recent fighters may be very long, as the engine power is sufficient to maintain speed even under high load factors.
- The maximum load factor is then maintained and speed decreased up to the maximum turn rate (corner speed), then the speed usually continues to decrease due to the high drag at high angle of attack (C).
- The post stall flight ability may then be used, for instance to point and shoot the target (D). The aircraft is very vulnerable then, as speed is low and maneuverability limited.
- This quick excursion into the post stall region is followed by the reduction of the angle of attack and by an acceleration phase, up to a speed sufficient to reengage a target (E).

The total time needed for the aircraft to cover this typical combat cycle is thought to be a good global indicator of its agility. The physical consequences of airframe agility on a human pilot should be regarded through the characteristics of each segment of this cycle.

3.5.2 Systems Agility

3.5.2.1 Definition and Scope

The system agility is defined as the ability to rapidly change functions of the individual systems which provide the pilot with his tactical awareness and his ability to direct and launch weapons in response to and to alter the environment in which he is operating.

The systems considered here are individual systems which provide the pilot with tactical information and elaborated functions, rather than low level aircraft systems such as the flight control system which is usually considered as a component of airframe agility, at least in its basic functions.

As such, onboard sensors are of course concerned as they are the main sources in function of information gathering. The countermeasures and electronic war systems may be concerned also as their speed of response is a key of their efficiency.

The off board systems and the ability to share information may also be considered as they play an increasing role in modern scenarios.

The above definition emphasizes the only objective of the systems agility which is to help the pilot to achieve his mission. Once again, the pilot-vehicle interface is actually a critical element for the contribution of systems agility to mission effectiveness.

3.5.2.2 Automation Benefits and Surprises

A high level of automation is necessary for the pilot to control the many complex systems of modern fighters, and it has proved to be mission effective most of the time.

For example, at the border between airframe agility and system agility, some advanced functions of carefree control systems have been developed, where aircraft limits are handled automatically. The automation of the aircraft limits may have some drawbacks under emergency or combat circumstances which require the full use of aircraft, but this problem is only the counterpart of the safety and mission effectiveness benefits, and the accurate design of the control laws makes it less and less sensitive.

More insidious may be the drawbacks of the automation of higher level functions, also sometimes referred to as automation surprises; while developments in cockpit automation result in workload reduction and economical advantages, they also raise a special class of human-machine interaction problems [19].

These problems have been examined in research addressing the last generation glass-cockpit civilian transport aircraft. They involve confusion on the status of the automated control system and the subsequent behavior of the aircraft. The complexity of the control system is accompanied with a partial knowledge of the system ; the pilot's knowledge is focused on the most frequently used automated modes, which may represent only a relatively small part of all the possible modes. A possible mismatch between the pilot's understanding of the system and the actual function performed by the system may occur under unusual conditions. Special training and pilot adaptation are the only compensation for an ill defined automated system and a poorly designed interface.

Although a consensus exists about the need for a feedback of the complex aircraft system to the pilot, special attention should be given to the level of feed back, i.e. the nature and the amount of information concerning the system functions that should be provided, displayed or made sensitive to the pilot.

The complexity of modern systems makes it obviously impossible and undesirable to display every item of information to the pilot, but a minimum level of information is certainly desirable to keep the pilot on line, so that he can take a decision when needed. For instance, information is probably required about the following points : which system functions are actually in control, what are the goals aimed by the system, what to do if a system function fails, and what to do once a goal is achieved.

Also, the level of information provided to the pilot may be context-dependent, as for instance the pilot doesn't always want feedback from the system when the feedback can distract him from the tactical situation. The precise determination of the level of information which is required and sufficient to achieve a mission is not possible today without practical experiments. The research studies about the processes underlying the building of situational awareness could provide some guidelines for the design of future pilot/system interfaces and appropriate pilot aids. Alternative control technologies may also contribute to the enhancement of man-machine communication [20].

The recent approach and development of human-centered automation may help avoid these drawbacks. Nevertheless, the interaction of human with complex system and thus, the contribution of systems agility into mission effectiveness, is still a non trivial problem. The introduction of automation should be driven by actual operational needs rather than by market or economical considerations.

3.5.2.3 *Emerging Technologies*

Some technologies contribute directly to increase the systems agility. These on-board or off-board technologies provide new capabilities and have a potential to deeply modify the pilot's situation awareness and tactics:

- Extension of the sensors range and angular coverage (radar, infra red, video or laser)
- Fast search mode and reduced update rates (electronically versus mechanically scanned radar)
- Multi tracks and improved classification/identification capacity
- Helmet Mounted Sights/Displays and target designation
- Missile Launch Detector and Missile Approach Warner
- Communication (high rate datalink) and Collaboration (C3, Third Party Targeting)
- Improvements of Navigation aids (GPS, digital maps)

For instance, the present days mechanically scanned radar is typically limited to +/- 60 degrees in coverage and cannot track numerous targets due to a relatively low update rate.

The electronically scanned radar and conformal antennas could provide substantial enhancements in terms of coverage, range and resistance to jamming, with direct consequences on the tactics. For instance, an angular coverage extended up to 120 degrees azimuth could allow the pilot to start going away from the target he has just shot, while still illuminating it (F-Pole maneuver).

Helmet Mounted Sights may allow an extension of the coverage to approximately +/- 100 degrees in azimuth and -30 degrees to +80 degrees in elevation, which may considerably modify the way of conducting closed in combat, especially if a target designation is made possible, using head or eye pointing rather than aircraft nose or velocity vector pointing [21].

The improved capacity of future aircraft to automatically share information within the patrol or with other forces or ground support will probably have some very large implications on the way a mission is conducted and on the role of the pilot. The recommended number of seats in an aircraft for a given mission may of course change as a consequence of this new capacity.

More generally, new concepts of task sharing between the vehicles, systems and individuals involved in a combat scenario are being considered and they really have to be in order to get the full benefit from the increasing level of agility of future systems.

3.5.3 **Weapons Agility**

The weapons agility is defined as the ability to engage rapidly characteristics of the weapons and its associated onboard system. The precision is also mentioned as a critical element of this definition.

The emerging concepts for future weapons include [adapted from 22]:

- Air-to-Air Weapons
 - Expanded envelope (minimum & maximum range)
 - Hypersonic speed
 - Increased off-Axis capability (lock-after-launch using HMS information)
 - Midcourse guidance and improved guidance (seeker performance, thrust vectored control)
 - High angle of attack employment
- Air-to-ground weapons :
 - Enhanced standoff capability
 - All weather capability
 - Improved accuracy
- New weapons
 - Non lethal weapons (especially laser)
 - Multirole weapons (A/A & A/G missile)

WEAPON SYSTEM AGILITY

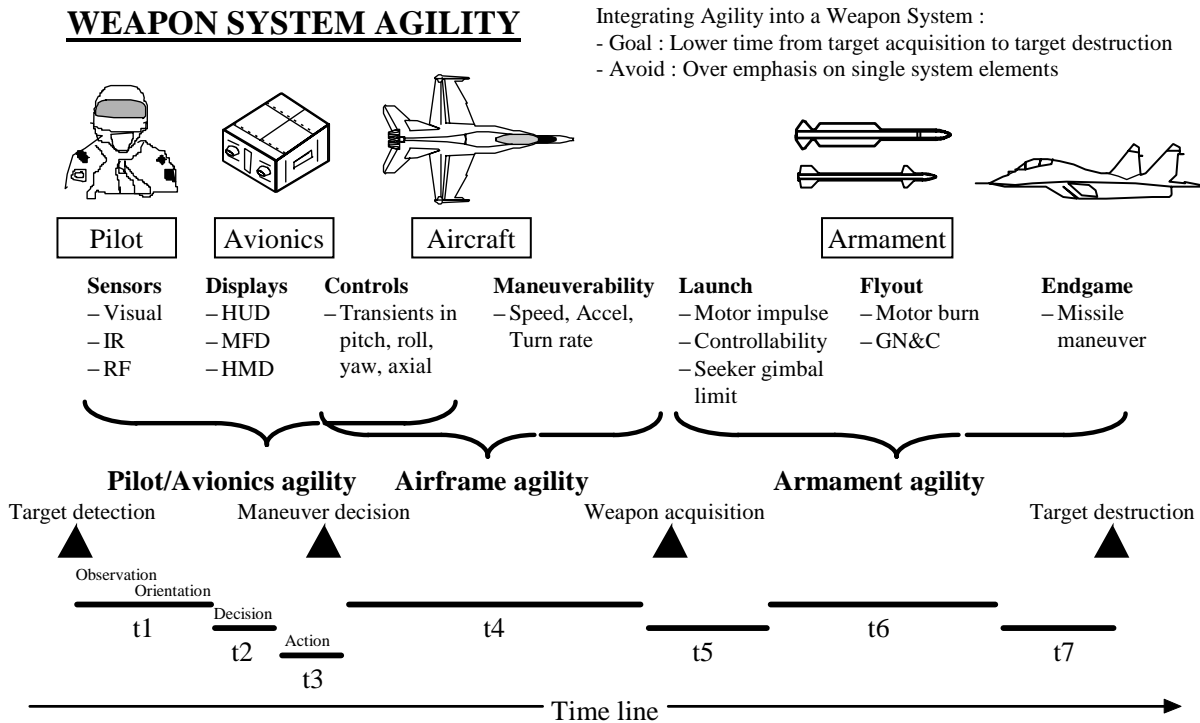

Figure 9: Weapon system agility [18].

For instance, the existing Russian AA-11 Archer short range missile provide some idea of the level of performance that may be obtained with modern air-to-air weapons [23]:

- Off boresight angle at launch up to 60 degrees
- Off boresight angular rate up to 60 degrees per second
- Launcher angle of attack up to 40 degrees

One tactical recommendation for a fighter against this new generation weapon is to avoid the short distance engagement.

Precise weapon agility data is of course usually classified, but one can expect that considerable progress has been made in air-to-air armament since the last large scale conflicts.

These progress are likely to strongly reduce the potential benefits of airframe agility, especially in the close in combat area.

3.6 OPERATIONAL AGILITY

Operational agility is close to the concept of weapon system agility proposed by Boyd in 1988 [5].

His model (Figure 9) includes seven time delays in the sequence of events between target detection and target destruction, including the Observe-Orient-Decide-Act (OODA) model for the pilot/avionics element.

This simplified model is of course valid only in a given mission context; it also lacks the role of external support and environmental factors.

However, it illustrates the fact that any gain in the time delays from the detection to the target destruction may be of crucial importance.

Although they are depicted as sequential, the time delays are actually not independent, as all the elements of the weapon system are closely interacting. For instance, the pilot's reaction time depends on the information displayed and maybe from physical factors such as the acceleration level; also, the attack maneuvers and thus the time required to get a shooting solution depends of the type of missile on board.

A hierarchy of the various components that contribute to operational agility was proposed by Working Group 19 (Figure 10).

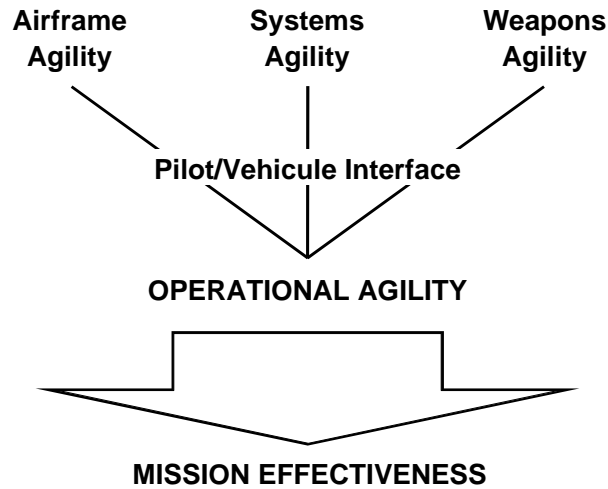

Figure 10: Hierarchy of operational agility [5].

The respective agility of each element of the global weapon system contributes at a similar level to the operational agility

In reality, the operational agility results from the correct interactions of all the elements rather than from the high agility of one single element.

Airframe, systems and weapons agility should not be considered separately, as the main contributor to mission efficiency is probably the consistency of the global combat system.

For instance, enhancing airframe agility by a post stall flight capacity may be useless if the firing systems are too slow to allow a quick shot or if the missiles cannot be launched at high angles of attack. Airframe agility may also become less useful if missile could be shot unlocked at very high off boresight angles, using an HMS.

The balance of the final weapon system and the best trade off between investment and efficiency is the main driver of an aircraft design. Many interesting technologies do exist and will not be applied despite their value because they cost too much and are simply not immediately consistent with the current needs or design philosophy.

Moreover, as long as the pilot is in control of the main tactical decisions, the pilot-vehicle interface will remain a key element into the operational agility hierarchy.

In particular, the potential benefits of high technologies may be impaired if the pilot is not given the tools to use them at best. Also, the introduction of automated functions requires a deep analysis of their potential implications as they may reveal unsuspected drawbacks once in operations.

Ergonomics should be given special attention at the design stage, to ensure that the objective level of operational agility will be attainable by a normally proficient air force pilot.

The following areas of preoccupation related to the issue of pilot-vehicle interaction and operational agility can be listed as follow:

- Physiological : pilot comfort, G protection, angular rates, spatial disorientation,...
- Ergonomics : cockpit, information, displays, controls,...
- Cognitive : workload, situation awareness, pilot assistance, task sharing,...

The operational agility may also require some particular approaches of selection, instruction and training for the next generation pilots.

The human consequences of operational agility have to be considered in the context of the present and possible future operational scenarios.

Those scenarios may present the following characteristics:

- Complex tactical environment with several forces involved : large quantity of information to be displayed and treated;
- Mission achieved in collaboration with allied forces : flexibility, communication ability and precision required;
- Various rules of engagement and political pressure : positive identification is usually required which increases risk taking and time pressure;
- Rapid reaction and localized conflict scenarios, generalization of multirole aircraft concepts with several mission objectives and targets of opportunity: need for a fast decision making;
- Possible new concepts about the role of the pilot: team work or unmanned aircraft to reduce the exposure to danger (“leave the pilot’s head in the aircraft, not the body”).

Those characteristics are at the same time a consequence and a motivation for an enhanced operational agility: agility is definitely a requirement in the information era, and its human implications have to be addressed.

3.7 REFERENCES

1. D.W. Repperger, WPAFB
A study of supermaneuverable flight trajectories through motion field simulation of a centrifuge simulator.
Journal of Dynamic Systems, Measurement and Control, vol. 114 (1992)
2. A.M. Skow, Eidetics
Agility as a contributor to design balance.
Journal of Aircraft vol. 29, no. 1 (1990)
3. 4-Power SNR SM TG
Practical limits of supermaneuverability and full envelope agility.
AIAA 96-3493 Conference Proceedings (Aug. 1996)
4. R.E. van Patten
Supermaneuverability and Superagility
Aeromedical and Training Digest, vol. 7, issue 1 (January 1993)
5. AGARD FMP WG 19
Operational Agility.
AGARD Advisory Report 314 (April 1994)
6. R.W. Barham, Lockheed
Thrust Vector aided Maneuvering of the YF-22 Advanced Tactical Fighter Prototype.
AGARD CP 548 FMP (March 1994)
7. P. Round, R.F. Tape
Propulsion system technologies for thrust vectoring.
AGARD Conference Proceedings 409 FMP (April 1986)
8. C. Fielding
Design of integrated flight and powerplant control systems.
AGARD Conference Proceedings 548 FMP (March 1994)
9. B. Sweetman
Fighter agility. The “ Bruce Lee ” factor.
International defense review 4/1990.
10. P.C. Stoliker and J.T. Bosworth
Evaluation of high-angle-of-attack handling qualities for the X-31A using standard evaluation maneuvers.
NASA Technical Memorandum 104322 (September 1996)
11. D.E. Canter, CDR A.W. Groves, NAS Patuxent River
X-31 Tactical Utility - Initial Results.
AGARD Conference Proceedings 548 FMP (March 1994)
12. J.C. Gibson, R.A. Hess
Stick and feel system design.
AGARD AG 332 FVP (March 1997)
13. Lt Col M.S. Francis
X-31 Demonstration of integrated flight and propulsion control for effective combat at extreme angles of attack.
AGARD CP 520 FMP/GCP (April 1993)

14. OTL Kim, Luftwaffe
X-31A Aircraft Agility & Tactics Pilot Perspective.
4-Power SNR SM TG Full Envelope Agility Proceedings (March 1995)
15. L.S. Small, K.L. Bonnema, WPAFB
F-16 MATV Development summary and flight test results.
4-Power SNR SM TG Full Envelope Agility Workshop Proceedings (March 1995)
16. G.D. Padfield, J. Hodgkinson
The influence of flying qualities on operational agility.
AGARD CP 548 FMP (March 1994)
17. F. Bournonville, L. Planckaert
Etude de performances des avions en terme d'agilité.
ONERA technical report n°93/26/IMFL (1993)
18. B.F. Tamrat
Fighter aircraft agility assessment concepts and their implication on future agile fighter design.
AIAA-88-4400 (September 1988)
19. N.B. Sarter, D.D. Woods
Pilot interaction with cockpit automation II : an experimental study of pilots' model and awareness of the flight management and guidance system.
International Journal of Aviation Psychology 4 (1994)
20. *Alternative control technologies : Human Factors issues.*
NATO-RTO-EN-3, HFM (October 1998)
21. U. Budiner, Elektroniksystem und Logistik GmbH
Sensors to support Future Combat Aircraft Missions
4-Power SNR SM TG Full Envelope Agility Workshop Proceedings (March 1995)
22. J.V. Kitowski, General Dynamics
Combat Effectiveness Methodology as a tool for Conceptual Fighter Design.
AIAA 92-1197 (February 1992)
23. G.A. Sokolovsky
Close air combat missile : AA-11
Proceedings of the Second International Conference Air Combat and Air delivered Weapons, London (February 1995)

4. PSYCHOLOGICAL CONSEQUENCES

J.Y. Grau

Institut de Medecine Aerospatiale du Service de Sante des Armees
B.P.73, Bretigny-sur-Orge Cedex F-91223
France

4.1. INTRODUCTION

The technological design and developments already applied to a number of aircraft, which represent the basis of tomorrow's aircraft, tend to change the tasks performed by pilots. Since the 80's, automation and computerization have invaded cockpits, leading to a change in the role of pilots. Whereas pilots used to need competencies directed towards handling and navigating the aircraft, what is now increasingly required of them is the ability to manage complex systems. With the arrival of new concepts like supermaneuverability and superagility, it seems extremely important to try and understand the psychological consequences these concepts will have on pilots. Enabling new types of operation, supermaneuverability and superagility alter existing tasks and will probably create new ones, which will have their own psychological constraints. What makes these constraints different from those existing on present aircraft, and what consequences could they have on pilot performance? These two questions can be addressed by two preliminary comments:

- As of today, supermaneuverability and superagility are still extremely novel concepts. Various "prototype" aircraft point to the developments, which will eventually make these concepts a reality in the near future, but there still is no such thing as "real" operational experience. The difficulty in accurately studying the consequences these future aircraft will have on pilots, lies in trying to define the exact role the pilot will be asked to play aboard.

- The psychological consequences studied will be limited to the consequences borne by the pilot in terms of taking and processing information. This chapter does not take into account psychological aspects based on personality or motivation.

The definition of supermaneuverability and superagility, or rather agility, gives rise to two fields of investigation regarding psychological consequences. These fields, far from being independent from each other, must be combined to clearly describe the psychological consequences borne by pilots. But, for clarity and comprehensiveness, it is best to study them separately, initially. The first one, supermaneuverability, refers to aircraft aerodynamic capacities. The psychological effects on pilots generated by the physiological stress resulting from this capacity need to be studied. The second one, agility, is connected to the operational capacities of these aircrafts. The aircraft must be assessed as an element within a global system, where it is a vehicle laden with on-board systems helping it achieve its mission in an operational environment.

4.2. PSYCHOLOGICAL CONSEQUENCES OF SUPERMANEUVERABILITY

Supermaneuverability refers to the unusual flight trajectories presently capable by high performance fighter aircraft (1). The trajectories illustrating supermaneuverability show that stress is mainly experienced by the pilot in terms of rotational and linear accelerations. These maneuvers are usually performed at low or medium altitude, and at low speed, under 450 kts, generally in a range between 70 and 265 kts. Vectorial thrust allows for pitch and yaw in ways impossible with more traditional aircraft. In terms of acceleration, supermaneuverability does not create any new stress that hasn't already been studied for physiological consequences. Linear acceleration amplitude and jolts are below the values generating serious physiological symptoms, such as blackouts or loss of consciousness. However, pilots can sometimes experience rotational acceleration that they are not used to, or combinations of accelerations they find unfamiliar. Psychologically, these accelerations can have two different consequences:

- Psychophysiological consequences due to the way information is perceived (i.e., trouble with perception), and the generation of sensory illusions and disorientation. These aspects developed above in this chapter.
- Psychomotor and cognitive consequences.

4.2.1. Effects of Accelerations on Psychomotor and Cognitive Performance

The psychomotor and cognitive consequences of linear acceleration have not been studied in depth yet. A review of the available literature shows that most of the work is centered on the loss of consciousness under +Gz acceleration: description of psychological symptoms leading to loss of consciousness and return of intellectual capacities after a loss of consciousness (2). For our purpose, the consequences on vision for medium intensity accelerations (3–5 +Gz), which are well known to pilots need to be noted: progressive reduction of field of vision, progressive loss of colored vision, drop in visual acuity, and the ultimate symptom, total blackout. These are all symptoms, which can directly alter the pilot's capacity of capturing information. The visual consequences of –Gz accelerations are also well known in the pilot community: a decrease in perceptual capacities, and negative scotoma in the visual field.

On the motor side, heaviness in head and limbs, associated to the difficulty of moving them, must be taken into account in all motor activities to be performed by the pilot, especially since these motor tasks can be further degraded because of the stress induced by the equipment worn.

Little work has been done on the effects on psychomotor and cognitive activities at acceleration rates that are lower than the thresholds associated with loss of consciousness. Brown and Lechner's survey (3) insists that acceleration has a negative impact on simple motor activities, complex activities (putting on a parachute) and cognitive processes (reaction time in choice making, time required to stabilize the aircraft after loss of control, etc.). But, as noted by the authors, there are few experiments and little data is available to check the real effects acceleration has on the various steps involved in information processing. Hendler's work, quoted by Forster and Cammarota (4) is interesting for maneuverability. It shows that performance during a tracking psychomotor task decreases as the time during which acceleration is applied increases. These authors conclude by saying that the change in acceleration level is more disabling to the performance of a psychomotor task than the acceleration level actually applied. Albery (5), aware of the fact that cockpit tasks are becoming increasingly cognitive in military aircraft, carried out a survey aimed at assessing workload during acceleration. Using Subjective Workload Assessment Technique, mental workloads during cognitive tasks performed in a centrifuge significantly increased acceleration plateaus (1.4 +Gz, 2.75 +Gz and 3.75 +Gz). This study is one of the few investigating the cognitive consequences of accelerations, but, as mentioned by the author, it is limited by the assessment method, which is global and hardly analyzes the underlying cognitive processes. In practice, such studies have strong methodology limitations for the generalization of results to real flight. The tasks easily accomplished in the centrifuge (target tracking, choice reaction time, etc.) to assess cognitive performance have a poor ecological validity for flying and real mission tasks. Albery and Chelette (6), in an experiment examining the effect of G-suits on cognitive performance, pointed out these limitations and encouraged the use of more realistic tasks.

For +Gx accelerations, the only data available in the literature involves high acceleration values, greater than 5 +Gx (2). Symptoms include limited head and limbs mobility and loss of peripheral vision. Starting at 7 +Gx, a psychomotor decrease is described, without any further detail. Effects of Gy acceleration are better known. It mainly generates problems of head support and limb mobility.

Effects of rotational acceleration on performance have also not been studied in depth (2). The main results describe diminution of psychomotor performance with high acceleration. Applying acceleration across time is also associated with human effects. The majority of the research addressing rotational acceleration, either alone or in combination with other accelerations, has focused on the effect of sensory illusions and disorientation.

4.2.2. Implications for Supermaneuverability

What bearing can this have, in terms of supermaneuverability? The psychological consequences of low and medium intensity accelerations have hardly been studied. The few available studies tend to show that psychomotor and cognitive capacities decrease under acceleration, without any details as to the nature of the degradation. On the other hand, these results were obtained with acceleration profiles different from those usually encountered in supermaneuverability. Caution is therefore required when generalizing the above mentioned results.

These two remarks illustrate the need to develop specific work in order to better grasp what psychological effects low and medium intensity accelerations may have. Such research should take into account the specifics of supermaneuverability, including acceleration combinations for which there is no available data. Investigating cognitive functions requires developing methodologies going beyond mere global performance analysis. These methodologies need to measure the changes in mechanisms involved in perception, analysis, understanding, decision-making and risk taking. Furthermore, in addition to analyzing the consequences which may be observed during the execution of specific maneuvers, it seems important to also take into account the tiredness or fatigue

which may occur when such maneuvers are repeated several times during a single mission. Physical and psychological fatigues are closely linked, and the fact that fatigue alters human reasoning capabilities is well known (7). These recommendations underline how important it is to take operational realities into account in designing any research on this topic.

From a practical point of view, the lack of available data requires investigation into what actually happens in squadrons. Despite the new stress of supermaneuverability, the pilots reported that they are not experiencing any increase in psychologically disabling stresses over that already occurring in non-supermaneuverable aircraft. Today, pilots empirically manage psychological consequences. Relying on their experience, pilots develop management, anticipation or avoidance strategies, which help them carry out their tasks. When faced with supermaneuverability, this acquired experience will probably be used to transfer strategies or adapt new ones. However, from a preventive point of view, the only way to develop effective management techniques is to have a better knowledge of psychological consequences.

4.3. INFORMATION PROCESSING AND AIRCRAFT AGILITY

Agility can be envisaged in two ways:

- In engineering terms, agility deals with the technological capacities of the aircraft and its systems. Using the definition given in chapter I, “system” agility can be broken down into weapons agility, systems agility and airframe agility. Each of these agilities can be considered in terms of the consequences this agility requirement will have on design: technological feasibility, definition of system functions, systems response time, computerized resources allocated to systems, command mode, information feedback, etc. This means that aircraft agility will be compounded by all agilities achieved, and that the aircraft’s agility level will be strongly dependent on the lowest agility achieved.

- The pilot has another way of perceiving agility: operational agility. For pilots, agility is the capacity of the human/machine couple to quickly shift from one target to another, in order to deliver a weapon. The performance of the pilot/aircraft couple will of course result from the technical capacities of the aircraft and its systems, but more notably from the extent to which the pilot exploits these capacities. In this respect, agility analysis is centered on the ability of pilots to manage the operational situations they are confronted with. The objective then is to assess which psychological characteristics help the pilot be as agile as possible. A different kind of agility can be added to the technical ones already mentioned above: “human” agility, which is the pilot’s capacity at managing the various existing technical agilities according to the operational situation at hand.

4.3.1. Describing Aeronautical Situations through Their Complexity

Aeronautical situations are said to be complex. But what does complexity actually mean, and how can a situation be described in connection with its complexity? The complexity of a situation involves several dimensions (8):

- The task and its characteristics,
- The knowledge required to complete the task, and
- The difficulty experienced by the pilot to implement the required knowledge in order to fulfill task goals.

Orasanu (9) describes a complex situation as a situation characterized by:

- Ill-structured problems,
- An uncertain and dynamic environment,
- Shifting, ill-defined, or competing goals,
- Action/feedback loops,
- Time stress,
- High stakes,
- Multiple players, and
- Organizational goals and norms.

These characteristics can all be found in aeronautical situations. The following question remains: is the complexity of air-to-air combat involving agile aircraft identical to the same combat situation with non-agile aircraft, and if not, what makes it different, and what consequences may this have on pilots? To answer these questions, it is necessary to look into the various elements of complexity.

4.3.1.1. The Task and Its Characteristics

The task and its characteristics are commonly referred to as complexity factors. They are description elements external to pilots, and help compare the complexity of various situations. Several categories of factors can be used to describe the complexity of a given task.

4.3.1.1.1. Time Factors

Task dynamics

Task dynamics are defined by the average length of time taken by the various steps in a task, and by the transition speed between steps. Combat tasks are eminently dynamic tasks. With agile aircraft, dynamics are increased during specific flight phases (attack and escape maneuvers), and during some sequences of systems use (arming or countermeasure systems). Increased task dynamics reduce the possibility of reversing actions performed by pilots, thus also reducing the possibility of detecting or correcting errors made.

Time pressure

Time pressure is the time available to understand, decide, and take action. It is a deadline. With agile aircraft, it seems that some flight phases and systems involve more time pressure than air-to-air combat schemes with traditional aircraft. For the pilot, an increase in time pressure means less time to analyze, alternative solutions envisaged before making a decision, and assess the consequences of these decisions for the medium and long terms. Time pressure is a factor, which increases pilot workload and stress.

Schedule of relevant information

Flying an aircraft is a task where information continuously flows in. Some information has an immediate relevance to the task, the moment it is perceived by the pilot. It is then integrated into the task underway. Other information has no specific value at the moment it is perceived by the pilot. However, it may be of value later on during further task developments, or may never be of any use (10). Managing the schedule of relevant information is an important factor of complexity in aeronautics, because unexpected situations are part and parcel of tasks performed. It is therefore difficult to know ahead of time what information will be of value during the mission. Since pilot memorization capacities are limited, pilot cannot remember everything. However, managing the schedule of relevant information does not seem to be more of a challenge with agile aircraft than in more traditional combat situations.

Time references

Pilot activity is organized around three time references (11):

- Physical time, i.e. the time frame used to keep track of developments in threat and environment. It is the time given by the clock.

- Systems time, i.e. non-compressible time units, which represent the operating or transition time of aircraft or on-board systems. For example, to execute a “post-stall” maneuver, aircraft aerodynamics requires an amount of time over which the pilot has no power. Another example: the transition time it takes to go from one weapon mode to another cannot be faster than what is required by the system. Systems time is important, because it is forced upon the pilot. The pilot must organize its activity around it.

- “Pilot” time is a kind of internal clock, specific to the pilot. It is the perception by the pilot of time passing by. This feeling is very different from physical time. Everyone knows that when you are bored, time is very long, whereas when you are busy, time flies. In aeronautics, pilot time is developed by experience; it is structured around memorized time sequences. It helps in adapting to changes in the environment and knowing: (i) when to take action, (ii) when control is possible, and (iii) when reasoning is possible.

The pilot lives with the continual difficulty of simultaneously managing these three time frames. With more and more automated and computerized systems in agile aircraft, systems time is an increasing constraint on the pilot. Successful combat requires systems time to coincide with clock time, which means having a proper time-based mental picture of the way systems operate, and of the way the environment changes.

4.3.1.1.2. Task Dimensionality

This term represents all the paths available to the pilot to reach the goal involved in the task. By creating new operational possibilities, agility multiplies the pilot’s possibilities of action: more maneuvers are possible, which can

all be coupled to different systems use. Each solution has its pros and cons, which the pilot must be aware of. Compounding this with time pressure, it becomes difficult to comprehensively assess all the available alternatives. Preference-based behavior often appears, favoring a solution readily “in mind”, rather than one which would be ideally appropriate for the situation.

4.3.1.1.3. Multiplicity of Goals

Air combat is a task which may be broken down into sub-tasks, each having specific goals. Managing goals, or giving priority to specific sub-tasks, is not always easy, especially since sometimes some goals compete with each other. For example, in air-to-air combat, success and security can be contradictory, in terms of the choices made by the pilot. Agility introduces nothing new in the management of goals than what is observed in more traditional air-to-air combat situations.

4.3.1.1.4. Risk-linked Factors

Moving around in four dimensions generates risks. In air combat, this risk is very high, because it is linked to the scope of possible aircraft movements and to the presence of one or more hostile elements, over which the pilot has no power. Amalberti (8) makes a distinction between two kinds of risks: objective external risks, illustrating the probability of having an accident, or failing the mission, and subjective internal risks, specific to the pilot, and representing its fear of not knowing how to perform, of not having the situation under control. In agility, the first risk depends on the operational capacities of hostile elements. But the second risk may be increasing, since the pilot might find it more difficult than usual to assess the situation and obtain satisfactory situation awareness. Risk is another element increasing workload and stress.

4.3.1.1.5. Multiple Players and Organizational Norms

These factors have no agility-related specificity.

4.3.1.1.6. Factors Specific to Systems and Their Design

These factors are important because they define the conditions under which pilots are required to complete tasks. On-board systems are more and more computerized. Automation has invaded the cockpit to increase performance. The basic flying tasks can be totally performed by systems (e.g. piloting, navigating). For other tasks (e.g. weapons, countermeasure management), systems partially support the pilot (see also Ergonomics chapter). Besides assisting the pilot, automation can cause problems. For instance, if the pilot only manages systems and does not directly pilot the aircraft, the pilot's flying ability can deteriorate and be inadequate should the automatic system fail. Moreover, automated systems can misrepresent a situation or provide erroneous data when they are not programmed correctly. Woods and al (12) expounded at length on these factors in the framework of human error, and spoke about “a clumsy use of computer technology”. Since sufficient information on systems equipping agile aircraft is still lacking. It is impossible to fully explore “systems ergonomics.” However, it is possible to identify several factors which will increase the complexity of the pilot's task onboard agile aircraft from the pilots' interviews conducted by the working group.

Systems logic

Systems operate according to mathematical and physics logic and do not always follow operational procedures, or use logic. This can result in additional complexity for the pilot, as the system's rationale, or the way the system arrived at the solution may not be obvious (13). “Transparency” of systems is often mentioned. For the pilot, this means, on the one hand, an increase in workload to understand or verify the way the system operates, and on the other hand, a confidence in the system (which is only relative, because its logic is sometimes “surprising”). Automation is likely to increase in agile aircraft to help the pilot handle task dynamics and time pressure and keep the pilot's workload compatible with mental capacities.

Multiplicity of information

Agility can only be envisaged with aircraft equipped with an ever increasing number of sensors, along with communication networks, which integrate all the aircraft in a fleet and the command and control systems. This information comes in addition to the data already available in the cockpit, to update aircraft and system status. The pilot is confronted with multiple pieces of information that are difficult to manage. The pilots especially found this a problem in the various screens displaying tactical situations. However, some data on weapons status, countermeasure management and aggressive hostile capacities are absolutely necessary. There are several kinds of pilot aids possible: more widespread use of the various sensory channels with multimodality displays, and the pre-processing

of data either by an assistant or human operator. Designing such aids is a challenge, and represents an open field of research for human factors. The consequence of this multiplicity of information is the risk of inadequate situation awareness with the potential of erroneous decision making.

Multiplicity of controls

In parallel with the multiplicity of information, many new controls have appeared in cockpits with multi-role combat aircrafts. The number of controls has considerably increased to use the different systems for both air-to-air and air-to-ground missions. For instance, Switches are more numerous, closer together, and often incorporated as a multifunction control, whereby the function of the switch changes, depending on the flight phase. The increasing complexity of the dialogue between the pilot and the systems increases the risks of making mistakes or of forgetting something, especially since pilot workload and stress are also on the increase.

Access to information

Multifunction displays are also more prevalent because it is impossible to simultaneously display all the information pertaining to the environment, aircraft, and systems. With the hierarchical organization of information, the displayed page may not correspond to the current functional needs of pilots. Moreover to access data on a different page, the pilot has to remember where the information is stored and have the time to perform the steps (usually button presses) to retrieve the desired information. These requirements are not always compatible with the task. To try to minimize workload, careful design of the dialogue is needed and the provision needs to be made for the pilot to pre-select desired functions, based on anticipated requirements in an upcoming complex flight phase. The display location in the cockpit is also important to relate to the current mission phase. Information needs to be displayed in the most convenient location for the pilot's current task. Any conflict between head-up and head-down displays for information retrieval could decrease pilot performance.

Feedbacks

Information feedback is a factor which Sarter and Woods (10) consider as essential for situation awareness. Feedback makes it possible to stay inside the control loop to make sure the desired goal is reached after the implementation of appropriate actions. It also makes it possible to detect errors made, and therefore to possibly remedy them. Another kind of feedback, just as important for the pilot, is the feedback provided by systems when they automatically change modes (e.g., when automatic pilot is engaged or during automatic changes of weapon system state during a delivery sequence). Feedback is also necessary on the state and potential possibilities of systems. There again, feedback allows the pilot to stay inside the monitoring loop, and to maintain adequate situation awareness. Feedback on the aircraft aerodynamics is especially important for agility management because many of the typical sensations are no longer available with integrated digital flight control systems.

4.3.1.2. Knowledge Required to Execute a Task

These factors involve the qualification of agile aircraft mission personnel. The qualification level is determined by psychomotor and cognitive abilities required of the pilot to successfully carry out missions. The identification and definition of these abilities is accomplished by analyzing tasks and pilot activity. Pilots can obtain the required abilities in two different ways:

- Through training, be it theoretical, by simulation, or in real life situations,
- Using existing pilot experience.

In terms of task complexity, this factor has little consequence for agile aircraft, because it is assumed from the start that the pilots are or will be adequately trained.

4.3.1.3. Difficulty Experienced by the Pilot

Task difficulty is subjective feeling, specific to each pilot. The more difficult the task is felt to be, the more the pilot will assess it as being complex. Difficulty can also be thought of as the outcome that reflects a person's experience, knowledge, and ability to manage situations and fulfill task goals (8). The pilot's performance results from the interaction between the situation, acquired expertise and stress level, "difficulty" being the way the pilot experiences this interaction. Performance is guided by the overwhelming concern to save cognitive resources, i.e. not to exceed their limits, and also the need to keep some in store to maintain a margin for adaptation (14).

In addition, stress generated by the mission stakes affects the way the pilot processes information. Cognitive effects of stress are well known and have to be taken into account to assess the pilot's performance. They include: reduced

thinking, "tunnel vision", excessive hurry, mental regression, "act at any cost" and mental block (15). Knowledge of these stress effects is important for training pilots and designing stress-resistant interfaces.

Fatigue is also an important factor to define the way the mission is difficult for the pilot. Mental and physical fatigue is closely linked in combat mission where physical and mental requirements are high. Fatigue has several effects on information processing mechanisms. Perception, memory, attention, understanding, decision making, risk making and action accuracy may be decreased (7)

In the framework of agile aircraft, it is difficult to know ahead of time how difficult things will be for the pilot. It will depend on aircraft ergonomics, pilot experience and, pilot's stress and fatigue states.

4.3.2. Human Agility

Human agility is a cognitive mechanism helping pilots answer questions on the status of the situation at hand. It also helps them make choices in order to reach the goals they set for themselves. In its interviews with pilots, the working group found pilots have to answer many questions during air-to-air combat. They can be summed up as follows:

- Where am I?
- Where am I going?
- Where are the enemies?
- Where are the enemies going?
- Where are friendly aircraft?
- Where are friendly aircraft going?
- What is the aircraft's energy status
- What is the status of on-board systems?
- What is my weapon delivery envelope?

The pilot will make the choices it feels are best adapted to meet the objectives, after integrating the answers to all these questions. It could seem that these questions contribute towards developing a solution that guarantees successful pilot performance. However, the reality is that in real world missions:

- The pilot has limited perception, memorization, information processing and action capacities,
- All the information is not available,
- Some information is uncertain,
- Other information is there, but difficult to perceive and understand,
- The situation changes rapidly, and unexpected or unknown events may occur, and
- The aircraft and its systems have their own limitations.

Despite all this, the pilot must face the situation, and develop cognitive strategies. Believing that the challenge of pilot performance lies within these strategies, the human factors community has decided to study them, and to address two specific aspects: situation awareness and decision making.

4.3.2.1. Situation Awareness

Situation awareness is a concept "intuitively" used by pilots when talking about understanding the tactical situation. Vogel (16) mentions that the term "situation awareness" was used in United State Air Force pilot manuals even before being defined. This notion being absolutely crucial to mission success, human factors specialists have looked into it, to offer a definition and to assess and describe what mechanisms come into play to build up and maintain situation awareness.

First distinction is necessary between situation awareness and spatial orientation. As Menu and Amalberti point out (17), spatial orientation is the capacity to position oneself in relation to a given fixed reference, represented by the horizontal and vertical directions in space. Situation awareness is the capacity to position oneself in relation to a relative reference system made up of the dynamic properties of the objects located in the geographical and tactical environment. Spatial orientation is a mechanism underlying situation awareness.

The literature provides two different approaches to research on situation awareness (18):

- One approach deals with the components of situation awareness. It is a “product” centered approach. One of the most comprehensive definition comes from Wickens (19): "situation awareness is a continuous extraction of environmental information about a system or environment, the integration with previous knowledge to form a coherent mental picture, and the use of that picture in directing further perception, anticipating and responding to future events". Through this definition, Wickens underlines that:

- a) situation awareness does not just involve perception, but also integrates understanding and anticipation (20),
- b) there is situation awareness of environment as well as of the aircraft and its systems,
- c) situation awareness not only helps to anticipate, but also to appropriately react to situations.

- The second approach studies the mechanisms by which cognitive resources are managed and adapted so the pilot can form a understandable and coherent mental picture representing the situation, continually updated with recurrent situation evaluations (10). This is a “process” centered approach, which stresses:

- a) the interdependence and non-linearity of memory, perception and action (18),
- b) the importance of time awareness and feedback (10), and
- c) the link between situation awareness, decision making and action (21).

The description of situation awareness properties and mechanisms helps to better understand the difficulties, which may be encountered in flying agile aircraft. Upon entry into a combat situation, the key challenge to pilots is how best to update their situation awareness:

- On the one hand, situation awareness needs to be sufficiently valid in time to avoid not being able to act and having to allocate all resources available into merely updating situation awareness,

- On the other hand, the pilot must be able to continuously integrate information, to update situation awareness and avoid working with mis-adapted situation awareness.

The answers to this conflict depend on the abilities of pilots to operate at various levels of understanding (22). For some situations, an abstract or "big picture" awareness is adequate, minimizing cognitive demands. The details to which situation awareness is updated can also vary, depending on the time and other resources available. Also, the pilot may decide to only attend to updating aspects that are critical to the situation. For example, in an air-to-air combat phase, having only a rough picture, or no picture at all, of the state of the inertial navigational system has no disabling effect on the ability of the pilot to engage in combat.

Ideally, human agility is such that pilots will be able to maintain adequate situation awareness, while optimizing resource allocation. However, in reality, one or more of the following are plausible for agile aircraft flight:

- Pilot has inadequate situation awareness due to the lack of information or because the knowledge required is not available,
- Pilot retains and outdated situation representation, because it does not have the resources necessary to change it,
- Pilot adopts too abstract of a representation leading to imprecise situation management,
- Pilot is not aware that its situation awareness is outdated. Captain Peeples (23) of United States Air Force talks about an “ultimate situation awareness” to describe a pilot’s capacity of being aware that he does not have an adequate situation awareness.

4.3.2.2. Decision-making

Decision-making has been extensively studied in aeronautics. At first, research work was carried out within normative approaches, trying to define an optimal decision making model. The work of Jensen (24) on Aeronautical Decision Making models must be mentioned. Extensively used to train pilots on decision-making, these models quickly proved their shortcomings, when trying to explain how pilots made decisions. Under Klein’s lead (21), a new approach to the modeling of the mechanisms involved in decision making, in real work situations, was developed: Naturalistic Decision Making. These studies, like recent studies on situation awareness, belong to the research movement focused on “situated” cognition.

Decision-making is not simply an algorithmic process analyzing all possible hypotheses to choose the best one. A decision is a cognitive mechanism constrained by the task at hand and the pilot’s expertise. Klein’s recognition-primed decision model (21) suggests the following:

- The more complex the constraints in a situation, the more decision strategies will be based on situation recognition, and not on analytical processes.
- Recognition of the situation generates an option, which then undergoes evaluation. If the option is deemed not valid or feasible, the pilot carries out a diagnosis to generate a new solution, and so forth. This is a serial process of option evaluation.
- If the situation is a familiar one, actions are carried out without further evaluation.
- The main difference between experienced pilots and more junior ones is not that the former have better reasoning, but that they have a better capacity at having a mental picture of the situation.
- The more expert the pilot, the quicker the situation will be recognized.
- The pilot is more likely to choose and execute an option that it is familiar with. In other words, the right decision is the decision the pilot knows how to implement.

It is expected that the demands of agile aircraft missions will further constrain decision making in numerous ways:

- There may be insufficient time to generate more than one or two options, making it more critical that these few options are appropriate for the situation
- The situation can change very rapidly, making the assessment of options more difficult,
- Consequently, there is increased likelihood that options, will be executed that have not undergone preliminary evaluation
- Given the agility of the airframe and weapons, it is more difficult to develop a three-dimensional picture of the situation and perform mental simulation of candidate options.

Having a better understanding of decision-making mechanisms makes it possible to envisage what could be done to enhance decision making. Beyond decision making aid or assistance systems, a very important aspect is to help pilots retain a greater number of previously evaluated tactics in their memory. This could help pilots react faster when there are insufficient resources to assess options in real time.

However, There is also a danger in allowing reasoning to be so rigid that it allows options to be executed without full evaluation as to whether they are appropriate. This mechanism is found in routine errors or "slips", as mentioned by Norman (25). Thus, additional techniques that can facilitate "agile decision making" are needed that enable pilots, while taking into account the ongoing dynamics of multiple aspects of a situation, are able to arrive and execute timely solutions which culminate in mission success.

4.4. CONCLUSION

The experience acquired on last generation combat aircraft and on "supermaneuverable" aircraft prototypes can be used to predict the consequences these concepts will possibly have on pilots' intellectual capacities and on information processing mechanisms.

Existing data show that the decrease in psychomotor capacities occurs mainly during changes in acceleration rates, and that there is an overall reduction in information processing capacities when the pilot passes through acceleration plateaus (perception, understanding, decision making). However, these results were obtained with experimental protocols having little in common with the acceleration profiles encountered in supermaneuverable aircraft. Thus, they must only be considered as a basis on which to conduct more specific research work. This research, in a first phase, should quantitatively and qualitatively assess the effects of accelerations on psychomotor and cognitive capacities, and in a second phase, assess these same capacities in the framework of supermaneuverability. The effects of acceleration on psychological capacities are not well known, but it is important to realize that pilots already experience these effects in traditional aircraft, and have probably learned to manage them, without any further formalization. There is no reason for the psychological consequences of supermaneuverability to be more serious than those already experienced in traditional aircraft. Of course, a better knowledge of this stress could help pilots develop better management techniques (training), and could help the design of adapted aids.

Superagility refers to the human/aircraft relationship, in view of reaching a goal. Beyond the mere agility of the airframe and its systems, human agility needs to be taken into account. Human agility results from information processing mechanisms, which lead to situation awareness and decision making. Analyzing the complexity linked to agility helps identify the various factors involved, and envisage the consequences they may have on information processing. The effects of these factors are analyzed through a "situated" approach of pilots at work, where pilot performance results from the interaction between the situation and pilot's expertise and within which the pilot manages cognitive compromises. Agility does not create new psychological constraints for the pilot, at least as such.

But it amplifies the constraints already existing in aeronautical situations. With agility, the pilot will find it increasingly difficult to manage cognitive compromises, and will tend to use information processing strategies, which increase the risk of mistakes or mis-adapted choices. The in-depth study of these mechanisms will help develop new training schemes for pilots, innovate systems and interface design, and provide assistance to pilots.

4.5. REFERENCES

1. Repperger D.W. A study of supermaneuverable flight trajectories through motion field simulation. *Journal of Dynamic Systems, Measurement and Control*. 1992; 114: 270-277.
2. Marotte H. Accélérations: Cours de Physiologie et d'Ergonomie Aérospatiale de l'Institut de Medecine Aérospatiale du Service de Sante des Armees. 1992; Brétigny-sur-Orge, FR.
3. Brown J.L. & Lechner M. Acceleration and human performance: a survey of research. *Journal of Aviation Medecine*. 1956; 27: 32-49.
4. Forster E.M. & Cammarota J.P. The effect of G-LOC on psychomotor performance and behavior. *Aviation, Space and Environmental Medicine*. 1993; 64: 132-8.
5. Albery W.B. The effect of sustained acceleration and noise on workload in human operators. *Aviation, Space and Environmental Medicine*. 1989; 60: 943-948.
6. Albery W.B. & Chelette, T.L. Effect of G-suit type on cognitive performance. *Aviation, Space and Environmental Medicine*. 1998; 69: 474-8.
7. Graber C. Aircrew fatigue and circadian rythmicity. In E.L. Wiener & D.C. Nagel, *Human Factors in Aviation*, Chpt 10. 1988; Academic Press, San-Diego, CA.
8. Amalberti R. *La conduite des systèmes à risques*. 1996; Presses Universitaires de France, collection le Travail Humain: Paris.
9. Orasanu J. The reinvention of decision making. In G.A. Klein, J. Orasanu, R. Calderwood & C. Zsombok (eds), *Decision making in action: models and methods* (pp 3-20). 1993; Norwood, NJ: Ablex Publishing Corporation.
10. Sarter N. & Woods D.D. Situation awareness: a critical but ill-defined phenomem. *International Journal of Aviation Psychology*. 1991; 1: 45-57.
11. Grau J.Y. & Amalberti R. La gestion du temps dans une tâche à forte contrainte temporelle : le pilotage de combat. *Médecine et Armées*. 1995; 23, 1.
12. Woods D.D., Johannesen L.J., Cook R.I. & Sarter N. *Behind human error: cognitive systems, computers, and hindsight*. CSERIAC, SOAR 94-01: Armstrong Laboratory, Wright Patterson AFB, OH. December 1994.
13. Wiener E.L. Cockpit automation. In E.L. Wiener. & D.C Nagel (eds), *Human Factors in Aviation*. 1988; Academic Press. San Diego, CA, 433-459.
14. Sarter N. & Woods D.D. Pilot interaction with cockpit automation II: an experimental study of pilot's models and awareness of the flight management system. *International Journal of Aviation Psychology*. 1994; 4: 1-28.
15. Dentan M.C. Stress and coping in the cockpit. In R. Amalberti (ed), *Briefings*. 1994; IFSA, Paris. 53-68.
16. Vogel E. SA: an operational point of view. In M. Vidulich, C. Dominguez, E. Vogel & G. McMillian (eds), *Situation awareness: papers and annotated bibliography*. 1994; Armstrong Laboratory, AL/CF-TR-1994-0085. June 1994. Dayton, OH.
17. Menu J.P. & Amalberti R. Les déterminants de l'appréciation de la situation tactique et le développement de systèmes d'aides ergonomiques. 1989; AGARD conference proceedings n° 478. AGARD, Neuilly-sur-seine, France.
18. Adams M.J., Tenney Y.J. & Pew R.W. Situation awareness and the cognitive management of complex systems. *Human Factors*. 1995; 37: 85-104.
19. Wickens C.D. Situation awareness: impact of automation and display technology. In Situation awareness: limitations and enhancement in the aviation environment. 1995; AGARD Conference proceedings CP-575. Neuilly-sur-Seine, France.
20. Endsley M. Design and evaluation for situation awareness enhancement. In Proceedings of the Human Factors Society 32nd Annual Meeting (pp. 97-101). 1988; Santa Monica, CA: Human Factors and Ergonomics Society.
21. Klein G.A. The recognition-primed decision (RDP) model: looking back, looking forward. In C.E. Zsombok & G.A. Klein (eds), *Naturalistic decision making*. 1997; Lawrence Erlbaum Associates: Mahwah, NJ.
22. Rasmussen, J. *Information processing and human-machine interaction*. 1986; Elsevier North Holland: Amsterdam.
23. Peeples D. The ultimate SA (situational awareness). *Flying Safety*. 1994; August 1994: 12-13.
24. Jensen R.S. *Pilot judgment and crew resource management*. 1995; Avebury Aviation, Ashgate Publishing Limited, Aldershot, UK.
25. Norman D.A. Categorization of action slips. *Psychological Review*. 1981; 88: 1-51.

5. PHYSIOLOGICAL CONSEQUENCES: CARDIOPULMONARY, VESTIBULAR, AND SENSORY ASPECTS

H. Welsch*, W. Albery**, and W. Bles***

*Flugmedizinisches Institut der Luftwaffe
Abteilung II – Flugphysiologie
Steinborner Strasse 43
D-01936 Koenigsbrueck, Germany

**Air Force Research Laboratory
AFRL/HEPA
2800 Q Street, Bldg #824
Wright-Patterson AFB OH 45433-7947, U.S.A.

***TNO Human Factors
PO Box 23
NL-3769 ZG Soesterberg, Netherlands

5.1 SUMMARY

Cardiovascular responses to agile flying will be affected primarily by the direction and magnitude of the accelerations. Maneuvers which first expose the pilot to less than 1 Gz, followed by an exposure to greater than 1 Gz (Push-Pull) can lead to problems. The aircraft's ability to reach high altitude within a very short time (due to a lift to weight ratio of more than 1) may produce new problems even during normal aircraft operation, e.g., decompression sickness (DCS). The incidence of vestibular problems may be increased by unconventional acceleration exposures. Sensory stimulations may be induced by high acceleration alterations in the roll, pitch, and yaw axes. Simultaneous combinations of aircraft accelerations in the x, y, and z axes can result in longitudinal, lateral, and vertical reaction forces on the pilot. Special restraints may be required for the agile aircraft pilot, especially in the lateral, Gy, direction. The support by an advanced G-protection garment may be needed. For "carefree" handling, the advanced G-protection device must work without any delay in time even during high acceleration transitions, must include high altitude protection, and must ensure pilot comfort. Furthermore special training devices are required such as the human centrifuge as a dynamic flight simulator (DFS) with a fully gimballed system, and a spatial (dis)orientation device with an effective motion system. Pilot selection and medical survey with highly sophisticated diagnostic tools will become more and more important. The need of special physical training will be required to enhance the aerobic endurance and the anaerobic power, to train the cardiovascular reflexes, and to increase psychomotoric stability and mental mobility.

5.2 INTRODUCTION

In respect of possible physiological consequences, superagility includes first of all the aircraft's capability to change its velocity vector in all directions and dimensions in a very short time. This does not only include new technologies to improve the post-stall capability of the aircraft by vectored thrust and fly-by-wire flight control systems, with fast alterations in the roll, pitch and yaw axes and low to medium altitude and low speed; it also concerns the ability of the aircraft to reach high-G loads, high altitude, and supersonic speed.

Physiological consequences may not only occur in the normal operation range of the agile aircraft, but also in extreme edges of the flight envelope and in emergencies. For safe operations with agile aircraft it will be necessary to consider special procedures in the process of pilot selection, survey, and training. Maneuvering in the post-stall regime may require new mental and physical abilities.

5.3 CARDIOPULMONARY ASPECTS

So far very few pilots have experienced high-agility flight with extreme acceleration stress. Therefore there are very little data in the literature that relate to the effects of G associated with agile flight. However, it is possible to

speculate about the acceleration stress experienced by pilots during enhanced fighter maneuverability (EFM) by looking at human centrifuge exposures in the dynamic flight simulation mode.

Cardiopulmonary effects during high-agility flight will be induced primarily by magnitude, direction, duration, frequency, and onset of acceleration exposure. During high agility, flight pilots will experience both impact acceleration with less than 1-second duration, and sustained acceleration during maneuvers that may be completed in several seconds.

To withstand acceleration forces, blood pressure has to be increased up to 300 mmHg by the left ventricle of the heart to reach a minimum diastolic blood pressure, at heart level, of more than 200 mmHg (Figure 5.1).

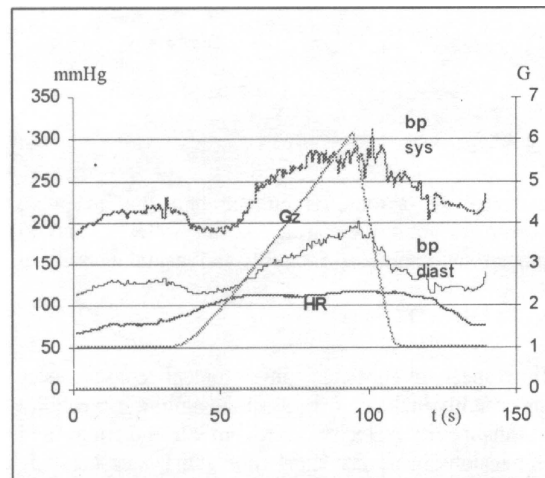

Figure 5.1 Blood Pressure (Systolic and Diastolic) Measured by Porta Pres® Method During a Linear Acceleration Profile with 0.1 G/s Onset up to +6 Gz

Positive pressure breathing assisted by a breathing regulator or induced by the pilot with active breathing techniques increase the intrapulmonary pressure up to 70-100 mmHg.

There is no doubt that this cardiopulmonary stress – even if the exposure time and frequency is short – demands a healthy cardiopulmonary system, confirmed by special medical selection procedures and continuous medical monitoring.

Despite lower peak Gz levels to be expected during EFM, G-induced loss of consciousness (G-LOC) as a result of cardiovascular decompensation during +Gz will become a greater threat. EFM will involve more frequent changes from -Gz to greater than +1 Gz. Transitions between zero or -Gz and +Gz are known to reduce human +Gz tolerance [1], termed the “push-pull effect” [2]. The decrease of blood pressure and heart rate by vasodilatation during any “push” phase less than +1 Gz will diminish human +Gz tolerance. The Canadian Forces reported that 17% of all G-LOC episodes have been related to the push-pull effect, several of them involving F-18 pilots who had been in control of the aircraft [3]. A review of United States Air Force (USAF) accident records determined that F-16s, F-15s, and even one A-10 and one T-37 were likely lost because of G-LOC due to the push-pull effect [10]. In a USAF Safety Center report on mishaps, attributed 21% of all class A mishaps (loss of pilot and/or \$1M damage to the aircraft) between 1991-1998 to spatial disorientation and 11% to G-LOC. Michaud et al [9] suggest as many as 7 of 24 class A mishaps attributed to USAF G-LOCs between 1982 - 1996 may have resulted from the push-pull maneuver. The safety agencies do not routinely specify the cause of the G-LOC, e.g. attributed to push-pull [10].

Increase of $\pm G_x$ or $\pm G_y$ during enhanced fighter maneuverability may not be followed by cardiovascular problems.

5.3.1 Threat of G-LOC

G-LOC will not only be caused by frequent transitions between -Gz and +Gz and the push-pull effect, but will also happen due to the capability of high agility aircraft to reach high +Gz levels within less than 1 second.

Normally there is no risk of G-LOC during accelerations lasting less than 1 second (impact) even with normal G-protection garments and even during push-pull maneuvers. The cardiovascular system is too slow to react. If the oxygen reserve of the brain is not exhausted by previous high +Gz maneuvers there will be enough capability to withstand high +Gz acceleration forces of short duration.

Figure 2 shows a push-pull maneuver in the interactive steering mode of the German human centrifuge, actively performed by a pilot with conventional anti-G trousers.

This push-pull maneuver is executed within 6 seconds. It starts at +1 Gz, reaches -0.5 Gz after 1 second, about another 2 seconds later the peak level of +9 Gz is reached. The duration of the G level above +8 Gz lasts about 1 second. Finally +1 Gz is reached 2 seconds later, again. No G-induced visual impairment, such as peripheral light loss, was reported.

But there is no doubt that G-LOC would have occurred if the G level of more than +8 Gz would have lasted for 1 second more.

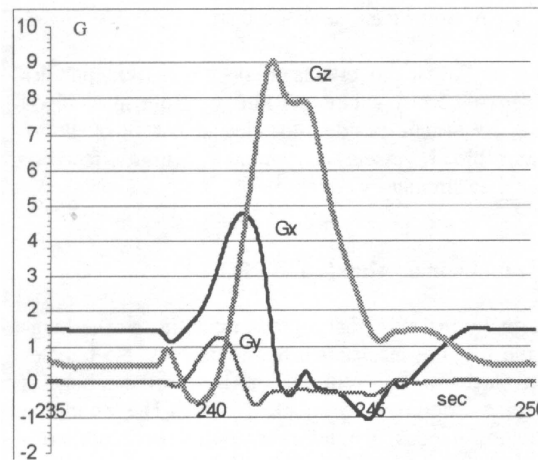

Figure 5.2 Active “Flown” Push-pull Maneuver on the Dynamic Flight Simulator (Human Centrifuge)

5.4 PROBLEMS WITH CURRENT ANTI-G SUITS

Pilots of current EFM-capable aircraft will wear anti-G suits designed for previous, non-agile aircraft. The original anti-G suit design is 60 years old, remains operational today, and with minor changes only. Even with an electronically controlled anti-G valve that regulates the flow of pressurized air into inflatable compartments in the G trousers, the pressure delivery to the trousers requires 1 to 3 seconds to achieve the demanded pressure for cardiovascular protection. The addition of positive-pressure breathing during +Gz (PBG) is a means to decrease fatigue and to enhance the effectiveness of the anti-G protection garment. However, currently there is no G-suit that is designed for EFM conditions. Even new anti-G valves that respond to rapid and continuous changes in the G suit pressure in order to adapt to frequent changes of G, will have some disadvantages.

5.4.1 Current Research in GZ Protection

For over the past three years a liquid activated anti-G suit (prototype “Libelle” of *Prospective Concepts AG*, Switzerland) has been evaluated in the dynamic flight simulator (human centrifuge) at Koenigsbrueck. With this prototype, pilots were able to perform any flight maneuver within the limits of -0.9 Gz and +10.4 Gz and with a maximum G-onset/offset of ± 5 G/s. They could use the head up display (HUD), head down display (HDD), throttle and stick in order to chase a target-A/C or perform clinical maneuvers (aerobatics) like a normal flight simulator or in the real aircraft. The evaluation of the suit was conducted under clinical and operational conditions, especially during profiles of a simulated A/C with high agility capability and frequent change of acceleration levels from base level up to a maximum +Gz without any arm pain and with remarkable less fatigue than expected. Simulated air combat maneuvers (SACM) were performed up to 10 minutes with G levels up to +10.4 Gz. There was no apparent decrease in situational awareness. Physiological parameters (e.g. ECG) showed no abnormalities.

Prototypes of the new hydrostatic suit “Libelle” demonstrated the ability to help the pilot to perform extreme agile maneuvers. Excellent anti-G protection was ensured without time delay during high G onset and offset rates. The avoidance of arm-pain was the most impressive result. Even as there is a wide individual spread in the maximum G levels during the passive acceleration profiles evaluation (due to “learning effects” and perhaps not exact custom fit), the operational benefit of the prototypes was convincing.

Since March 2000, the Libelle has been evaluated by USAF pilots and flight surgeons on centrifuges at Holloman AFB and Brooks AFB, and at the Test Pilot School, Edwards AFB. The evaluation did not exceed 9 G in both the centrifuge and flight tests. In general, the evaluation team had a favorable opinion of the Libelle, which offers certain advantages over the current F-15 and F-16 G protection ensemble, COMBAT EDGE [8].

5.5 NEED FOR RESEARCH AND TRAINING

Up to now there is only little information about physical demands imposed by high-agility flight. Understanding these complex translational, rotational, and gyroscopic phenomena requires reassessment of well-established concepts. While some speculation has occurred on the effects of G in high-agility flight, this is mostly based on gradual or rapid G-onset studies, which are not representative for high-agility accelerations. The human physiology may be the limiting factor in high-agility flight. G-LOC mishaps, visual problems, and vestibular illusions will limit pilot’s G tolerance in this environment.

The acquiring and understanding of human factors in EFM flight will be the central topic in the future. Validated laboratory tools are proven experimental methods and are needed as well as acceleration devices capable of producing $\pm G_z$, $\pm G_y$, and $\pm G_x$. These modern human centrifuges should be able to simulate EFM acceleration profiles. The capability of reliable transitions between $-G_z$ and $+G_z$, active powered gimbals to reach angular velocities of at least 10 rad/s², and acceleration onsets of more than 10 G/s will be technical requirements to understand the human physiology in the envelope of fourth generation aircraft and to optimize crew protection systems.

France, Sweden, and Great Britain are constructing new advanced human centrifuges. The German Air Force is planning to upgrade its human centrifuges to meet the specified requirements.

Furthermore, physical fitness training and education must have high priority for Eurofighter (EF) “Typhoon” aircrew. Training facilities should be collocated with EF squadron accommodations. Aerobic endurance, anaerobic strength, and the capability of coordination are a must for efficient anti-G protection.

5.6 CARDIOPULMONARY EFFECTS OF DECOMPRESSION BUBBLES

Raising the ceiling of current flight operations will lead to an increase in altitude exposure hazard and consequent incidence of decompression sickness (DCS) symptoms. Agile aircraft like the F-22 and the EF are capable of reaching a flight altitude of 60,000 ft with a climb rate of 50,000 ft/min. With the current cockpit pressurization schedule there is more than a theoretical chance for the pilot to experience DCS, when wearing the common aircrew equipment [4, 5].

A pressure altitude of 21,500 ft seems to be the critical threshold where the incidence of DCS increases rapidly and the chance to experience DCS symptoms is greater than 50%. With the normal cockpit pressurization schedule, the critical cockpit pressure altitude of 21,500 ft will be reached at 48,000 ft flight altitude.

One hundred percent oxygen is necessary to provide additional protection. It is highly recommended that the cabin pressure differential should be increased to at least 6 PSI instead of the current 5 PSI. For escape or in case of rapid decompression in a flight altitude above 50,000 ft the pilot has to be equipped with a (partial) pressure suit. There is no doubt that a partial or even a full pressure suit will decrease the pilot’s mobility and comfort. New concepts for protective garments have to be developed.

5.7 VENOUS GAS EMBOLI (VGE) AND DCS

Bubbles are routinely detected in the venous blood (venous gas emboli) after decompression at altitudes above 12,000 ft. As the more common occurrence of DCS relates to limb pain (bends), cardiovascular effects of decompression bubbles should be discussed. The scope of the magnitude of the problem is proportionally related to the gradient of decompression (pressure/time relationship) and the amount of gas bubble formations. Not only after rapid

decompression, but also during ascent in an altitude chamber with a climb rate of 4,000 ft/min, bubble formation can be detected. Knowing this, it is to be assumed that gas bubble formations will occur during high performance takeoff or rapid cabin pressure changes during maximum climb rate maneuvers in an air combat scenario.

The cardiovascular effects of decompression bubbles are presented by symptoms ranging from local blood flow abnormalities, due to mechanical blockage of minor blood vessels, to complex neural effects or complete circulatory collapse.

5.8 INTRAPULMONARY SHUNTS AND PATENT FORAMEN OVALE (PFO)

Normally the pulmonary microcirculation in the lungs is the filtering mechanism of the bubbles. No bubbles can reach the left ventricle of the heart and no bubbles become arterial gas emboli (AGE). The condition whereby venous bubbles cross into pulmonary capillaries may be pulmonary hypertension – induced by anti-G breathing techniques or positive pressure breathing during G load (PBG) or in high altitude (PBA). In addition to that, pulmonary hypertension might open extra-alveolar arteriovenous shunts, allowing VGE to spill over and to become AGE [4].

The prevalence for a patent foramen ovale (PFO) is 20-30% in the human population [4]. A PFO is essential for fetal life since it allows blood to pass from the right heart to the left heart in order to bypass the collapsed fetal lungs. Usually within the first year of life this foramen will be closed. Even if there is no anatomical closure by fibrous adhesions the foramen is usually functionally closed because the pressure in the left atrium of the heart is generally higher than in the right atrium.

Venous gas emboli induced by altitude decompression may pass the PFO even in normal pressure environments. The functionally atrial right-to-left shunt allows the gas emboli to cross over when rapid and substantial venous flow to the right heart occurs. Typical situations are:

- G offset
- Cessation of positive pressure breathing
- Cessation of the L-1 or M-1 anti-G straining maneuver
- Valsalva maneuver
- Coughing

With the new envelope of modern agile fighters the exposure of the pilot to extreme physiological stress is not only likely but probable. Exposure to extreme low pressure without the benefit of deitrogenisation or full protective coverage is likely to be capable of producing silent or overt DCS symptoms. Exposure to assisted positive pressure breathing (PPB) in excess of 60 mmHg in a population likely hiding a 25% incidence of PFO may produce right-to-left atrial shunting as a consequence.

One consequence is discussed and it is recommended that an extension of the echocardiographic examination will be introduced at pilot selection for fourth general aircraft. The German Air Force Institute of Aviation Medicine has already established the transoesophageal echocardiography for the medical examination of EF pilot candidates.

5.9 NEUROMUSCULAR ASPECTS

The macrogravity environment ($G > 1$) of conventional flight can be a difficult environment in which to work and fly. When this environment begins to introduce unconventional acceleration exposures, such as that experienced in the agile aircraft environment, the ability to control the aircraft and fly the aircraft can become more difficult.

The pilot becomes heavier in the seat as G increases. Arms, legs, torso, and head all become heavier, and with the same motor control and musculoskeletal systems used at normal 1 G, man initially has problems controlling movements of the head, arms, and legs at high G. Increased gravitational fields increase the weight of body parts. Body parts can become elongated or compressed under the G vector; this can affect the shape and function of the soft internal organs including the heart, lungs, kidneys, liver, etc. Higher muscle forces are required to keep the head, torso, and limbs in desired positions. At G forces of approximately +2 Gz, there is increased pressure on the buttocks, drooping of the face, and noticeably increased weight of all body parts; at this level of G force it is difficult to raise oneself, and at +3-4 Gz it is nearly impossible. Above +3-4 Gz, controlled motions require greater effort, accommodation, and learning to offset loss of fine motor control. While seated in a high performance aircraft, one typically cannot raise the arm at greater than 8 Gz, or legs at greater than 3 Gz. Head pitching is difficult at greater than 4 Gz and some individuals who get

their heads pitched forward at high Gz (>6 G) are unable to right themselves in the seat until the acceleration is unloaded. The hand can be raised slightly at 25 Gz. One can barely slide the feet on a floor above 5 Gz. Speech is severely affected, yet possible up to +9 Gz if the operator is utilizing protective techniques properly. When reaching for a switch on the instrument panel at high Gz the tendency of the pilot is to end up below the switch because the arm is now heavier due to increased +Gz. The pilot learns after several attempts to initiate the trajectory of the arm-hand at a location above the switch. In experiments conducted in the Dynamic Environment Simulator (DES) centrifuge at Wright-Patterson AFB, subjects' combined Gx + Gz or Gy + Gz tolerance was measured. The purpose of the study was to determine whether or not combined acceleration axes affected overall G tolerance. In thrust-vector aircraft, it is possible to generate multi-axis accelerations as various supermaneuvers are performed. Gx exposures ranged from -1 Gx to +4 Gx. Gy exposures ranged from $\pm 1 - \pm 2$ Gy. Helmet and shoulder restraints were required for the Gy exposures. One interesting observation from this research is that as subjects lose eye-level blood pressure with Gz +Gy exposure, they tend to lose vision in the eye opposite the direction of the sustained lateral acceleration (i.e., +Gy, linear motion to the left, the right eye loses vision first). None of the 10 subjects had problems tolerating the levels of combined accelerations.

One of the potential neuromuscular consequences of flight involving changing accelerations is biomechanical feedthrough (BFT). BFT is the additional force exerted by the arm on a controller (such as a throttle or control stick) as result of G forces acting on the arm. A good example of this can occur while one is driving a car. If one makes a sharp turn and the arm is on the top of the steering wheel, the lateral force on the arm tends to pull the arm in the direction opposite the turn. As the arm is pulled, the tendency for the arm to pull the steering wheel back in the opposite direction of the turn is due to the additional weight of the arm under lateral sustained acceleration. The biomechanics of the situation are fedthrough the arm to the steering column which can affect driving performance.

The same situation can occur in flight. If one accelerates the aircraft while holding onto the control stick, the translation (x) force against the arm has the tendency to pull the arm after which can lead to a pitching up of the aircraft. Likewise, lateral forces can be transmitted via the arms and legs and affect the throttle, control sticks, and rudder pedals.

5.10 VESTIBULAR AND SENSORY ASPECTS

Discussing the sensory consequences of enhanced fighter maneuverability, the ability to execute maneuvers in the post-stall regime, with controlled side slip (lateral acceleration) and with high angle of attack (AOA) far beyond the maximum lift and aerodynamic limits, is most relevant. This "supermaneuverability" is enabled by thrust vector control, aerodynamic design, fly-by-wire flight control system, and a thrust-to-weight ratio exceeding 1.

The human complex stress envelope in supermaneuverable flight discussed is controversial. In the post-stall regime it is expected that maximum +Gz will be less than in current aircraft, but 0 or -Gz will be much more frequent due to negative AOA in the energy recovery phase. However, agile flight includes also high speed turns, like defensive or avoidance maneuvers, even during supersonic speed. Positive acceleration peak levels up to +15 Gz and in the negative Gz regime up to -10 Gz have to be expected. Although of a very short duration, high G onset, G offset, and possible G transition between negative and positive G load (push-pull maneuvers) will have to be faced. In addition to the cardiovascular effects, sensory and vestibular symptoms will increase and may become the limiting factor during agile flight.

Albery [6] estimated that maximum Gx values are within the limits of ± 6.5 G with a maximum G onset and G offset of ± 5 G/s. The yaw authority may increase lateral accelerations during agile flight up to ± 4 Gy with maximum G onset and G offset of ± 2 G/s. X-31 test flight results, however, showed nearly no \pm Gy acceleration forces since zero side slip was programmed into the X-31 flight computer. Lateral Gs decrease the pilot's handling capability. To avoid this, these "yaw-looking" maneuvers were flown by high roll rates (up to 240°/s) with high AOA. Nevertheless when initiating the roll input, impact-like Gys, due to the high angular accelerations can't be avoided.

The linear acceleration transitions and the high angular accelerations (pitch: $\pm 180^\circ/s$, roll, $\pm 360^\circ/s$, yaw: $\pm 90^\circ/s$ with extremely high onsets and offsets may increase vestibular disturbance and possible spatial disorientation.

5.10.1 Consequences of Supermaneuvering for Semicircular Canals and Otoliths

The magnitudes of angular accelerations as provided by Albery [6] are not beyond the normal sensory function of the semicircular canals. One may even expect that the canal responses, as for instance, during the Cobra- or the Herbst-maneuver, will rather accurately reflect the actual angular motion because of the fast rotations over a limited angle.

Simply said, acceleration will deviate the cupula back in the original position. This happens faster than the 2nd-order canal characteristics are able to neutralize the response during the rotation. This implies that most of the time the nystagmic response will be adequate as well during post-stall maneuvering. However, linear accelerations in supermaneuvering aircraft are most probably different to those of conventional aircraft as they affect the pilot from all directions. Moreover, the magnitude of the acceleration vector will vary but will be most of the time, exceeding 1 G, perhaps up to 4 G during post-stall maneuvering. In that case, the gain of the canal response in terms of nystagmus or in terms of motion perception may be different from the optimum response at 1 G. Evidence for these interactions is available from parabolic flight experiments.

The G loads encountered will not destroy the otolith system, as the G loads in the post-stall regime will be smaller than pulled in conventional high-performance aircraft. On the other hand, G loads > 3 G will generate nystagmus which will be inadequate given the situation [7].

It is also of interest that the intersubjective variability in the magnitude of this nystagmus is considerable, as is the capability to suppress the nystagmus by visual fixation. There is not much known about the horizontal nystagmus following stimulation along the Gy axis because of unpleasant attitude for subjects in conditions of Gy >2. This would require further research.

For a more detailed analysis of the perceptual consequences of the sensory system involved, the combined recordings in linear- and angular- encountered acceleration should be available for model simulation.

5.10.2 Subjective Vertical and Spatial Orientation

The central vestibular system will have problems in accurately interpreting the otolith input if it concerns a sustained G load. Present motion perception concepts believe in low pass filtering of the otolith output to preserve gravity, while the canal response is also involved in the internal reconstruction process of the gravity vector, the subjective vertical. In view of increased G load and its changing directions – even without a detailed analysis – it is obvious that this will result in a subjective vertical that does not correspond to the gravity vector.

For current spatial orientation the system has to rely on the visual information. According to the present models on visual-vestibular interactions, post-stall maneuvering should not pose insolvable problems to the data processing of the sensory systems involved in maintaining spatial orientation. But this is only true as long as there is ample vision, position, and motion information available. This is in accordance to the verbal reports of the test pilots.

It is feasible that the movement of the aircraft as such is more provocative for the vestibular data handling when the head is fixed to the head rest compared to the pilots in air-to-air combat maneuvering trying to keep their gaze and consequently their head fixed on the adversary. In this case the angular motion of the head is much more natural than the motion of the aircraft, and therefore more easily and accurately to handle.

Although one would imagine that a high angle-of-attack (AOA) causes a difficult perception of the flight path, X-31 pilots consider it to be no problem in visual air combat, because the target is used as the reference.

5.10.3 Pilot Reports

No additional human factors or physiological limitations were encountered on the X-31, after flying the F-16, F-18, or F-4 aircraft. Disorientation was not encountered. But all X-31 missions were flown in daylight, in visual meteorological conditions (VMC), with excellent sight and good horizon. All the missions were flown after hours and hours in the flight simulator.

Flying in poor weather, poor visibility with no horizon, with intermittent instrumental meteorological conditions (IMC), few visual cues and alternating “head down” conditions could pose orientation problems. “Head inside” was not enjoyed. “Carefree” handling and maneuvering is important in all fighter aircraft. It allows full attention to be paid to the adversary and the tactical situation: full situational awareness without the distraction in the melee that one’s own aircraft may depart its own control envelope.

The X-31 flight control system (FCS) was set up to provide post-stall maneuvering with zero side slip. This gave little Gy and very comfortable maneuvering.

The reports of the pilots were encouraging in view of the predicted problems due to the complex sensory stimulation. However, it might be that clear visibility is a prerequisite for this achievement. Therefore, it was assumed that at least the adversary as a reference point – even as a virtual picture in the primary flight instrument – must be integrated into the leading sense, the vision, to avoid spatial disorientation in VMC.

5.10.4 Research Tools

Because of the G-loads applied to the pilot from different directions, a research tool with centrifuge capabilities and a fully gimballed system is required, as well as full visual displays. Dependent on the particular goal of the research, choices can be made between several systems available (Table 1). Another brand new system, located in the Netherlands, seems to be capable to do research in this area. It is fully three-axis gimballed system with visual displays, called “Desdemona”. It also allows heave over 2 meters, and may displace itself along an 8 meter track, which is placed on a rotator, allowing centrifugal forces up to 3G. (Figure 4).

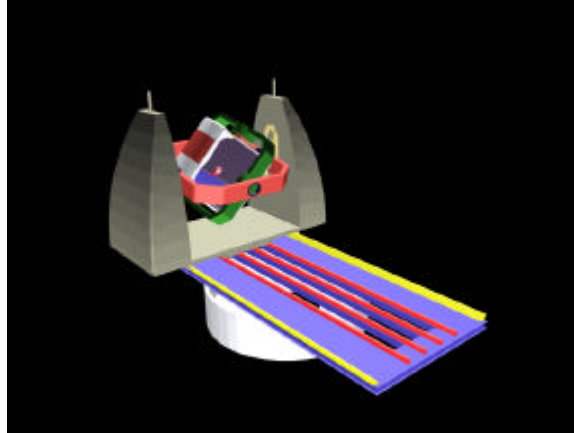

Figure 5.3 Desdemona Spatial Disorientation Research Device

5.10.5 Vision and Vestibular Illusions

Pilots rely on flight instruments as their primary defense against visual and vestibular illusions and loss of situational awareness. The various head up display (HUD) designs, attitude indicators (AI), and associated primary flight instruments allow the pilot to determine spatial orientation relative to the earth in degraded visibility. Translational and rotational accelerations are known to affect spatial orientation through induced vestibular and proprioceptive illusions. Loss of spatial orientation can lead to loss of situational awareness.

Current AI/HUDs display a two dimensional depiction of the aircraft attitude relative to the horizon. Neither instrument effectively displays the yaw or the velocity vector. Most airspeed indicators are pneumatically driven and become unreliable below the stall-speed. Thus, the pilot of an EFM-capable aircraft, flying at high-AOA during post stall maneuvering, employing current flight instrument displays, would receive inadequate orientation and velocity information. A HUD design in the X-31 depicting the velocity vector has proven confusing. Vestibular illusions, not yet identified, will lead to pilot misperceptions of flight orientation that may be difficult to counter with existing instrument displays. Improved instrumentation will be needed to counter the severe vestibular illusions that will certainly be associated with EFM especially in poor weather conditions.

Off-boresight targeting may pose problems in terms of a second visual frame reference, which will affect the situational awareness of the own aircraft. Since this depends also on the visual information, off-boresight targeting may easily lead to disorientation. Aircraft orientation specific symbology in the HUD or the helmet mounted displays (HMD) will enable the pilot to remain fully aware of his situation but may lead to disorientation.

Spatial orientation of pilots will be especially challenged by lateral (G_y) and longitudinal (G_x) accelerations that will be experienced during angular accelerations and high AOA. High agility fighter pilots will experience lateral G in combination with long radius angular acceleration. The effects of this combination are unknown and will likely be associated with currently unidentified vestibular illusions. While the natural tendency of any pilot might be to reposition the head in the direction of rotation, preoccupation with tactics may not allow orienting compensating movements. Thus, there will be a large combination of possible disorientating stimuli. The speed of rotation in EFM-capable fighter aircraft may be significantly greater than that seen previously, and may be combined with other acceleration stress. Head movements during yaw maneuvers may provoke disorientation and motion sickness.

Several important illusions in non-agile aircraft were identified only after loss of aircraft. A notable example, the somatogravic illusion, occurs during aircraft carrier take-off or rapid acceleration in fighter aircraft. Spatial orientation can be expected to be a serious limitation in EFM-capable fighter aircraft.

5.10.6 Motion Sickness

As discussed above, based on the vestibular information, the vertical will differ in magnitude and in direction from the gravity vector. Current motion sickness modeling is based on the concept that the main conflict causing motion sickness is the difference between the vertical as determined from the sensory inputs and the vertical as determined on the basis of previous motion information. Beside this sensory-caused mismatch situation the misperception from sensory cues and delayed visual cues, independent from the vertical, may cause motion sickness, like simulator sickness.

In view of the fast maneuvering it is unlikely that in a two-seater the internal model of the “passenger” can keep up with the sensory side, giving sufficient conflict to provoke motion sickness. Since expectancy plays a large roll in motion perception, and the pilot is in control of the maneuvers, this will enable the internal model of the pilot to keep up with the sensory side. Moreover, as indicated by the pilot reports, the sorties flown so far were in good visual conditions, allowing the visual system to correct for the vestibular insufficiencies in determining the vertical. These two factors should reduce the chance of motion sickness considerably.

In view of the above one should avoid conflicting frames of reference, for instance symbology on the HUD in the helmet (HMD) should be consistent during head movements. In general, dissociation between the reference frames of the head, helmet, display and airframe should be avoided. Although motion sickness may be encountered in conventional aircraft, supermaneuvering is thought to have an even more provocative character. Extensive training and gradual acquaintance with this type of maneuvering should be considered using (dis)orientation trainers, advanced centrifuges (Table 5), inverted time (ground: gyro-wheel, triplex, somersault-swing, and in the air) aerobatics in aerobatic aircraft.

5.10.7 Countermeasures

Spatial Disorientation (SD) in superagile aircraft is a threat, which is not different from the threat in conventional aircraft. Just as in normal aircraft, spatial disorientation in threat because it may occur unexpectedly. This applies also to the superagile aircraft when they are not engaged in supermaneuvering. During supermaneuvering a Type 1 (unrecognized) SD is highly unlikely to occur, but Type 2 (recognized) can occur easily in poor visual conditions. Although it will be recognized easily, it may be difficult to recover, because of the dissociation between the velocity vector of the aircraft and the aircraft attitude.

It is obvious that normal procedure training and training of additional skills (such as recovery from Type 2 SD) is required.

Several of the items discussed above are at present under investigation. A survey of the relevant items to be studied for supermaneuverable aircraft handling is useful, as is joined research since the research tools are expensive and therefore scarce.

Demonstration and training of supermaneuvers in ground based devices should give responses similar to what is encountered in the air. Otherwise an internal model will be built which does not correspond to the real situation. Since the real conditions may cause motion sickness as well, one should carefully differentiate between motion sickness and simulator sickness in the ground based devices. One should be aware that G-seats are of limited value in supermaneuvering aircraft simulators because of the G-load coming from directions other than the pilot’s z-direction (see chapter 8).

Tactile cueing and 3D-audio could be tools that are helpful in maintaining spatial orientation during supermaneuvering, and therefore help to prevent motion sickness. Whether this is true indeed, requires a considerable research effort.

FACILITY	TYPE DEVICE	NUMBER OF X,Y,Z AXES SIMULATED	MAX (ONSET)	VISUAL DISPLAY	RATING
DES (WPAFB)	Gimbaled Centrifuge	2	20 G (1 G/s)	120° X 60°	Good-7
DFS (VEDA)	Gimbaled Centrifuge	2	40 G (13 G/s)	90° X 30°	Excellent – 9
GAF IAM (Koenigsbrueck, Germany)	Gimbaled Centrifuge	2	12 G (5 G/s)	24° X 32°	Good-8
Singapore AF	Gimbaled Centrifuge	2	15 G (6 G/s)		Good-7
U.S. Navy (Lemoore NAS)	Gimbaled Centrifuge	2	15 G (6 G/s)		Good-7
LAMARS (WPAFB)	5 DOF Flight Simulator	3	(1.6 G/s)	266° X 108°	Good-5

Table 5.1 Supermaneuverable Simulator Matrix (Ground Based)

5.8 REFERENCES

1. Lehr, A.K., Prior A.R.J., et al., Previous Exposure to Negative Gz Reduces + Gz Tolerance. *Aviat. Space Environ. Med.* 1992; 63:405
2. Banks, R., et al., The Push-Pull Effect to Negative Gz Reduces Relaxed +Gz Tolerance. *Aviat. Space Environ. Med.* 1994; 65: 699-704.
3. Latchman, S. and Greenlaw, W., The Incidence of G-LOC in the Canadian Forces, 1996, Operational Research Division Air Command Headquarters; Winnipeg, Manitoba, Canada.
4. Pilmanis, A.A., 1990 Hypobaric Decompression Sickness Workshop: Summary and Conclusion. The Proceedings of the 1990 Hypobaric Decompression Sickness Workshop USAF/AL Special Report (1991).
5. Pilmanis, A.A., Raising the Operational Ceiling: A Workshop on the Life Support and Physiological Issue of Flight at 60,000 Feet and Above. AL/CF-SR-1995-0021 (December 1995).
6. Albery, W., Simulations in Final Report of Working Group 27 to RTO of NATO, Chapter 8, 2000.
7. Marcus, T., van Holten, C.R., Vestibulo-ocular Responses in Man to +Gz Hypergravity. *Aviat. Space Environ. Med.* 1990; 61: 631-635.
8. Demity, P., U.S. Air Force Evaluation of the Libelle Water Augmented Anti-G suit, panel to be presented at SAFE. Reno NV, 9-11 October 2000.
9. Michaud, V., Lyons, T., and Hansen, C., Frequency of the “Push-Pull Effect” in US Air Force Fighter Operations, *Aviat. Space Environ. Med.* 1998; 69, 11: 1083-1086.
10. Michaud, V. and Lyons, T., The “Push-Pull Effect” and G-Induced Loss of Consciousness Accidents in the US Air Force, *Aviat. Space Environ. Med.*, 1998; 69:11: 1104-1106.

6. PILOT-VEHICLE INTERFACE

G. Calhoun*, P. Le Blaye, and H. Welsch*****

*Air Force Research Laboratory (HECP)
2255 H Street, Building 33
Wright-Patterson Air Force Base OH 45433-7022 U.S

** ONERA
System Control and Flight Dynamics Department (DCSD)
Base Aérienne 701, 13 661 Salon Air FRANCE

*** Flugmedizinisches Institut der Luftwaffe
Abteilung II - Flugphysiologic
Steinborner Strasse 43
D-01936 Koenigsbrueck GERMANY

6.1. OVERVIEW

The steady development and integration of advances in aerodynamics, flight control, propulsion, materials, equipment, structures, and avionics promise to make agile aircraft a reality. Through these developments, exciting new capabilities in agile airframes, agile weapons, and agile systems will be available to pilots. However, the ergonomic design of the pilot-vehicle interface (PVI) for agile aircraft poses a more difficult challenge, compared to designing earlier high performance aircraft [1]. For instance, the high angular rates, accelerations, and onset rates of agile airframes place heavy demands on pilots and life support systems. If these fail, ejection from an unconstrained flight envelope makes additional demands on egress systems. With minimal constraints on angle-of-attack and expanded weapon launch envelopes, novel display formats will be required that enable pilots to fly with references well beyond conventional fields-of-view. Improvements in aircraft dynamics and weapons capabilities have also led to a dramatic increase in the tempo of the tactical situation. This, in turn, reduces the pilot's available processing and decision time. Decision aids and automated subsystems are required to help pilots cope with these increasing demands, while also maintaining situational awareness (SA). Recent advancements in sensor and off board information technology have resulted in an explosion in the complexity and sheer quantity of information that potentially can be displayed to the pilot. Efficient displays, utilizing these technologies, are needed to provide pilots with the "right data, in the right place, at the right time." Efficient controls are also needed to enable pilots to command and operate equipment quickly and accurately. In sum, agile aircraft, in terms of airframe, weapons, and systems, introduce new requirements and performance standards for crew station design.

Since the pilot-vehicle interface is closely tied to each of these agility elements, it is an important feature of agile aircraft. This pilot interface must make optimal use of pilots' abilities, while recognizing their human limitations. To accomplish this and realize the capabilities afforded by an agile airframe, agile weapons, and agile systems, the pilot must become the prime focus of design, which will in turn help determine the best interface for coupling the pilot tightly to the agile aircraft. As Licklider stated in 1960, in the very first issue of the *IEEE Transactions on Human Factors in Electronics* [2]:

"Man-computer symbiosis is an expected development in cooperative interaction between man and electronic computers. It will involve very close coupling between the human and the electronic members of the partnership. The main aims are 1) to let computers facilitate formulative thinking as they now facilitate the solution of formulated problems, and 2) to enable men and computers to cooperate in making decisions and controlling complex situations..."

After forty years of research and development, it is evident that technological revolutions do not necessarily promote "man-computer symbiosis." In many of today's aircraft, pilots are over worked, motivating them to turn off potentially helpful advanced systems that they simply do not have the resources to deal with. It is questionable in some designs whether the crew station serves the pilot or vice versa. With the additional capabilities afforded by agile aircraft, it is paramount that pilot-cockpit synergy be regarded a key design objective.

This Chapter will address this design objective as well as other ergonomic issues pertaining to agile aircraft. First, pilot protection and survival will be considered. Next, design issues relevant to controls and displays will be presented. The

concepts and technologies proposed as candidate solutions to afford pilots more protection and create pilot-cockpit synergy for agile aircraft applications are, for the most part, largely untested at present. It is hoped that this Chapter will provide the impetus for the basic and applied research required to realize ergonomic designs that will enhance the operation of agile aircraft.

6.2. PERSONNEL PROTECTION IMPLICATIONS OF AGILE AIRCRAFT

Personnel protection in agile aircraft will not only involve the aircrew equipment and life support system, which is the case in existing aircraft [3], but the summary and combination of anthropometric cockpit design, life support systems, crew escape systems, aircrew equipment, flight- and target information systems (displays, symbologies), and aircraft handling (controls). All these systems and items must work together properly in order to guarantee the safe handling of the agile aircraft within the whole envelope and for all flying conditions: normal, adverse, and extreme, including emergency situations. Personnel protection is the *summary* of active and passive devices in the cockpit.

6.2.1. CURRENT PERSONNEL PROTECTION

Personnel protection of the aircrew is both personnel aircrew equipment:

- helmet (impact protection and noise reduction)
- visors (ultraviolet, sun glare, laser, and wind blast-protection)
- helmet mounted devices for target and flight information
- oxygen mask (altitude protection, positive pressure breathing with high G and altitude, anti-drowning facility)
- advanced anti-G-protection garment, positive pressure breathing
- water immersion equipment
- thermal protection garments, cooling vest
- nuclear, biological, and chemical (NBC)-equipment

and

- pressurisation of the cockpit with safety against decompression sickness
- air-conditioning of the cockpit
- auto pilot flying modes
- warning systems (visual, aural (voice) and/or tactile) and attention alerts, and
- ejection seat.

6.2.2. AGILE AIRCRAFT IMPLICATIONS ON PERSONNEL PROTECTION

6.2.2.1. “ELECTRONIC CREWMEMBER”

Flying on the borderline or beyond the aerodynamic envelope – high AOA, extremely high G-onset, and high roll-rates – demands more than an anthropometric designed cockpit, personnel aircrew equipment, personnel life support systems, and improved crew escape systems. In addition to these basic personnel safety systems during normal operations, smart electronic systems (i.e., the software of the flight- and engine-management system) will be required to ensure the safe envelope of both the aircraft and the pilot in the cockpit. An “electronic crewmember” is needed to indicate the best solution for winning and/or surviving in combat situations. In turn, the pilot needs methods for interacting with the “electronic crewmember” (e.g., eye-based control, speech commands or by manual inputs with the hands-on-throttle-and-stick (see 6.4). Additionally, it is desirable that the “electronic crewmember” has the capability to take the lead in an advanced agile (inhabited) flying weapon system, upon pilot consent [4, 5].

Given that safe operation of uninhabited aircraft (UAV) [6, 7] has been demonstrated and current systems enable precise navigation, it is even possible for the “electronic crewmember” to assume sole command and safely land the aircraft, with the pilot. This might occur based on the pilot’s command (e.g., direct voice input or button selections that designate the automatic systems to be employed). Possibilities include selecting systems which automatically 1) initiate the full aircraft recovery/landing, 2) initiate flight manoeuvres as a defensive aid steering system, or 3) maintain the current flight profile established by the pilot. Activation of an automatic system by an “electronic crewmember” may also be based on inputs from a physiological surveillance system that detects when the pilot is incapacitated.

Having an “electronic crewmember” responsible for the last consequence should not be viewed as solely a scenario for the far future. There are many near term factors that can hinder pilots’ ability to control, fly, and land the aircraft. Examples include: G-LOC induced incapacitation, flash blindness, blindness by laser weapons, inadequate SA due to high angular inputs, or reduced motor or mental capability due to the effects of biological and/or chemical agents. With the near term availability of smart electronic systems, their application should significantly reduce the number of pilot and aircraft losses.

6.2.2.2. PERSONNEL HEAD EQUIPMENT

The flight helmet with visor(s) and oxygen mask is a multifunctional part of the personnel equipment. In former times, the flight helmet was mainly a part of the life support system. Today's flight helmets must enable interaction with the "electronic crewmember" (e.g., direct voice input), in addition to providing protection.

The flight helmet must provide oxygen support with effective and necessary positive pressure with acceleration and altitude. It must also protect the pilot from many hazards (sun glare, lasers, wind blast, NBC), not slip with acceleration and vibration and be shock absorbent and water immersion safe. Moreover, the helmet must be lightweight, especially to avoid neck injuries during the high accelerations and angular velocities anticipated during flight operations in the agile envelope. Compromise will undoubtedly be required between the demands for a lightweight helmet and the requirements for visor integrated electronic devices and ejection safety.

6.2.2.3. PERSONNEL GARMENT

The flight suit for the agile aircraft pilot needs to integrate G-protection, thermal protection, NBC-protection, and water immersion protection, as well as guarantee an individual selectable microclimate for pilot comfort. This last factor is a key challenge, as the latest generation anti-G equipment covers nearly 80% of the body surface with air and vapour impermeable material. The interim solution of providing a cooling vest might be psychologically helpful, but it is counter productive from a physiological perspective. When sweat cannot be transferred away from the body, the cooling of the body surface causes an increase in the body core temperature by vasoconstriction of the superficial blood vessels in the skin.

In addition to the poor microclimate, the anti-G equipment of current garment approaches can fail to provide timely effective pressurisation. Specifically, the anti-G valves and/or the amount of pressurised gas in the bladders might be inadequate for agile airframes that are capable of high G-onset and offset rates, in combination with high-sustained G. Further research is needed with advanced G-protection systems which do not impose a time delay in activation and guarantee protection up to +12 Gz (and perhaps +15 Gz). Moreover, the anti-G system must operate in a manner that provides the pilot full SA of changes in the environment. For superagile aircraft operations, pilots' physical health, as well as long term effects must be considered.

For rapid changes in the direction and amount of gravitation forces, a smart anti-G-valve component of an advanced G-protection system must protect the pilot, not disturb the pilot. In addition to this passive protection, there should be a warning system that informs the pilot on approaching conditions that will exceed the pilot's individual physical capacity limits. For carefree handling during close-in-fight scenarios or defensive missile avoidance manoeuvres, there should be a "learning" anti-G-valve. Such an adaptive valve remembers not only the last flying manoeuvres, but also the endurance of the manoeuvre and the pilot's physical responses. This might be especially important during repeated G-offset and onset (push-pull phenomenon) conditions. During normal flight operations, the pilot should be able to choose the maximum G-limits and G-onset limits of the flight control system, within the limits imposed by the weight and configuration of the aircraft. In addition to this capability to pre-set limits, there should also be a means for the pilot to override these selections, in the event there is a need to respond in a dangerous situation by pushing the limits of the pilot-aircraft system.

6.2.2.4. LIFE SUPPORT SYSTEMS

Advances in life support systems are required to meet the demands posed by agile aircraft which are capable of reaching very high altitudes, flying extremely low (terrain following), and flying with supersonic speed. Moreover, these airframes can fly in the post stall regime with vectored thrust, at high angles of attack and/or high roll rates. It is possible that the airframe will experience high sustained and/or rapidly changing G-loads, even in the supersonic area.

For cases in which an agile aircraft reaches altitudes in the range of 50,000-60,000 feet within 60 seconds, it is likely that the pilot will suffer from decompression sickness (DCS) with current common garments and cockpit pressurisation schedules [8, 9]. A pressure altitude of 21,500 ft is the critical threshold altitude at which point the incidence of DCS increases rapidly and the probability of DCS onset is greater than 50%. With the normal cockpit pressurisation schedule, the critical cockpit pressure altitude of 21,500 ft will be reached around 48,000 feet flying altitude.

Therefore the decision must be made whether to: 1) change the pressurisation schedule (7 PSI instead of 5 PSI differential pressure) or 2) equip the pilot with a (partial) pressure suit. Both alternative solutions have disadvantages and risks. Perhaps the highest risk is under conditions of rapid decompression, when the differential pressure is 7 PSI. A partial or even full pressure suit under these conditions would decrease the mobility and comfort of the pilot. This mobility degradation could have consequences in the ability of the pilot to accomplish the mission.

6.2.2.5. CREW ESCAPE SYSTEMS

With increases in airframe agility, it is possible that there will be situations where it is necessary for the pilot to complete a high velocity emergency egress (over 625 knots air speed) at an unusual attitude (high AOA). There are

devices that are designed to protect the pilot in Gy accelerations in flight, in addition to the movements and accelerations likely to be experienced after cockpit egress. These include restraint systems, ejection seats with special devices against wind blast (case, windshield), and anatomically designed seats. Egress systems are integrated into the aircraft's flight control system to use, upon initiation, the aircraft's actual attitude, altitude, flight-path, roll rate, AOA, G-load data for safe recovery. With agile airframes, high angular velocities may be especially problematic. Methods by which neck injuries can be avoided during escape, without requiring the head to be stabilised or fixed (or protected by a case or shield) are needed [10, 11, 12].

6.2.2.6. COCKPIT ERGONOMICS

Given the tremendous costs associated with each aircraft and the capabilities of modern technologies, it is incumbent to integrate systems such that the best protection for the aircraft and pilot can be achieved. First, methods for optimising information display and control are needed due to the complexity of cockpit systems. Second, systems which provide visual contact with a target, despite the presence of clouds, haze, or darkness (ground proximity warning systems, anti collision warning systems and artificial target imaging systems) are especially necessary for pilots of agile aircraft to maintain SA.

The flight control system can also provide "automatic recovery" of the aircraft. Such a system would take the lead, when it is detected that the pilot is not making necessary inputs for safe flying (e.g., when the pilot is wounded or suffering from G-LOC or LSA). "Recovery" may be simply "straight and level recovery" when the pilot selects the appropriate button. A more sophisticated recovery system directed at avoiding *all* dangerous situations could perform at several levels:

- auto-recovery and stabilisation of straight and level (flight control system) may be followed by
- automatic flight to the next suitable (or home) airbase with the use of GPS and other navigation systems and the use of special algorithms,
- automatic landing systems, and/or a
- smart ejection seat (with attitude stabilisation, even in unusual aircraft attitudes).

Certainly, the capability for the pilot to override the automatic system must be provided at all times, even if the "electronic crewmember" calculates that the aircraft is beyond the safe operational limits of the flying envelope.

6.3. CONTROL AND DISPLAY IMPLICATIONS OF AGILE AIRCRAFT

6.3.1. CURRENT AND ANTICIPATED CONTROLS/DISPLAYS

As can be seen in an overview of 21st Century fighters [13], the revolution in crew station design is evident in current high performance aircraft and primary post-2000 fighters. Typically, these crew station designs feature a head-up display to present data relative to aircraft handling, navigation, air and ground target acquisition and weapon release. In addition, multiple head down multifunction displays present data pertaining to flight systems, weapons, horizontal situation, tactical overview, and sensors. Fly-by-wire integrated flight control systems (IFCS) and a "hands-on-throttle-and-stick" (HOTAS) control concept (the latter for integrated control of radar and weapon aiming) are primarily utilized. Some cockpit designs plan to include even more advanced controls and displays, such as direct voice interfaces and helmet mounted displays. These changes in crew station design are proof that the laboratory technologies of the 1970s and 1980s are finally coming of age.

6.3.2. AGILE AIRCRAFT IMPLICATIONS ON CONTROLS AND DISPLAYS

Agile aircraft have the potential to provide enhanced speed, range, flexibility, and lethality. In order to exploit these benefits, the warfighter must be able to assess situations, decide tactics to be employed, and execute responses under rapid, highly uncertain and temporally demanding combat conditions. Unfortunately, improvements in airframe manoeuvrability, acceleration tolerance, wide area surveillance, positioning/locating devices, precision targeting, data processing and communications, and precision munitions have all tended to *complicate* cockpit design. For pilots to perform the same basic task – finding the opposition and destroying it – they now have even more "helpful" systems. Attending to all these information sources is impossible, given that pilot combat workload is already at maximum. At the very least, some of the investment expended on increasing agility will be wasted. Worst yet, the increased complexity of the crew station design may overload pilots' perceptual and cognitive processing capabilities, increase workload, and ultimately degrade mission effectiveness.

For pilots to realize the benefits afforded by agile aircraft, crew station designs must facilitate the potential synergy between SA, the manoeuvrability envelope, and systems [14]. For instance, enhanced manoeuvrability will not increase survival rates, if pilots do not realize that a change in flight path is recommended. Moreover, if pilots on a flight path ending with ground impact have real-time updates of their situation, they can choose when to alter their flight path – they can choose whether to change the path immediately, or wait until the final moment the envelop allows escape.

Likewise, if pilots are cognizant of a threat, but weapon selection is time consuming, they may not be able to exploit the advantages of increased manoeuvrability. On the other hand, simple and direct means of changing weapon settings may achieve a tactical advantage without arduous manoeuvring [14]. Thus, crew station design with the goal of pilot-cockpit synergy has the potential to provide the flexibility to maximum mission effectiveness.

These examples illustrate the potential flexibility provided by a crew station design that emphasizes synergism. In this manner, the design of a truly “agile” aircraft requires that all systems, including the pilot-cockpit interface, be agile. In turn, a “pilot-cockpit symbiosis” can be realized, whereby the pilot and the agile aircraft systems “cooperate in making decisions and controlling complex situations” [2]. The complex situations facing future warfighters involve achieving and maintaining tactical advantage for finding and destroying the opposition. To accomplish this, pilots must be aware and able to respond to the total situation. The controls and displays used in agile aircraft determine how fast and accurately the pilot can assimilate the required information and execute control procedures. In fact, it is this communication between the crew station and the pilot that is the limiting factor in the ability of pilots to exploit the advantages afforded by agile systems. Indeed, there are some specific design issues presented by new capabilities, and these will be mentioned in the remainder of this chapter. However, it is the *multitude* of systems that constitute agile aircraft that make the pilots’ information management task the primary challenge and key determinant of successful deployment. Therefore, the primary focus of the following discussion will be on how ergonomic design can help pilots give commands to agile aircraft and systems and obtain information from agile aircraft and systems. First “head up” and “head down” controls and displays will be explored. Then, other crew station design issues will be addressed.

6.4. HEAD UP CONTROLS AND DISPLAYS

The advantages of providing and controlling information “head up” have been recognized for a long time [15]. This approach maximizes the amount of time the pilot spends looking out the canopy for airborne and ground threats and minimizes time looking down in the cockpit. Head up capability can even be provided with devices located down in the cockpit, as long as their operation does not require redirection of the pilot’s gaze. To date, this advantage is primarily realized with a head up control concept and a head up display (HUD). Head up control is achieved with additional switches located on the flight controls; this HOTAS concept enables selection of many sensor, navigation, and weapon systems, as well as flight control inputs, without redirection of the pilot’s gaze point. A HUD presents symbology projected onto a transparent combiner. Some information, such as a pitch ladder that relates directly to the world, can be seen superimposed on the real scene to facilitate display interpretation. The display can also relay a sensor image, providing a view of the scene ahead at night or bad weather. Because the HUD combiner is fixed to the top of the instrument panel, the pilot must look forward along the aircraft longitudinal axis to see the symbology. Moreover, targets often lie outside the limited field-of-view (FOV) of a HUD during tactical manoeuvres.

Helmet mounted displays (HMDs) have been developed as one means of extending the advantages of the head up transparent display concept and overcoming limitations of current HUDs. An HMD can provide a wider area of visual information than can be viewed with a HUD. Moreover, with a HMD, displayed information is within the pilot’s FOV regardless of head movement and orientation. Because of their utility when the pilot looks both along and away from the fore-aft axis of the aircraft, HMDs are predicted to eventually eliminate the need for HUDs.

When implemented with a head/helmet position tracker, a HMD system can also provide target cueing and sensor guidance. In addition, these Helmet Mounted Display/Tracker (HMD/T) Systems have tremendous capability compared to earlier Helmet Mounted Sights (HMS) that combined a tracker with a sighting reticle to provide a simple aiming mark to pilots. HMD/T systems, along with other “head up” control and display devices (e.g., HOTAS, auditory cueing systems and speech-based control), enable pilots to focus attention out the window and minimize manual control and head down glances which can cause disorientation and/or vertigo, especially in extreme +/-G. This is even more critical for agile aircraft to support manoeuvring, weapons launch, and evasion/survival. Before describing some candidate head up controls and displays, some pertinent design issues will be presented.

As expected, the changes made in aircraft design to realize an agile airframe make a sophisticated and IFCS system a definite requirement. Moreover, the advantages of a carefree handling system can now be realized. The next section (6.4.1) will address in detail these *flight control* implications introduced by agile airframes. In regards to the actual cockpit, though, the Working Group’s interviews with pilots indicated that special devices are not required to exploit the advantages of agile airframes. However, the pilots did raise several control and display design issues for agile aircraft *systems*. These will be introduced in 6.4.2.

6.4.1. IMPLICATIONS OF AIRFRAME AGILITY ON FLIGHT CONTROLS

The aircraft controls consist of the pilot’s inceptors primarily used to handle the aircraft and can be operated with the head up. These controls are primarily related to the aircraft flying qualities.

The airframe agility is defined as *its ability to change, rapidly and precisely, its flight path vector or pointing axis and to its ease of completing that change.*

Even though relationships between handling and flying qualities are already well-known for conventional aircraft and can be evaluated with existing criteria (MIL-STD-1797 or ADS33, mainly based on the Cooper Harper scale), possible conflicts between flying qualities and performance have to be addressed when high levels of airframe agility are to be achieved and operationally used. Specific pilot-centered and mission-oriented metrics should first be developed to be able to address those conflicts at the aircraft design stage [16].

High airframe agility may be achieved by adequate aerodynamic design and by various devices, such as extra aerodynamic control surfaces, forebody vortex control, and pitch-only or pitch-yaw thrust vectoring. The number of elementary controls devices, the dynamics required to control the aircraft in the unconventional flight regime (high angles of attack), the non-linear behavior of the aircraft in those conditions, the necessary adjustments of the engine air intakes, together with the natural instability of the airframe necessary to achieve high manoeuvrability, are all numerous factors which require a sophisticated and IFCS system.

Now almost in operation, the thrust vectoring solution has two possible applications:

- improve the handling qualities and expand the flight envelope (high agility, post stall flight (PST), short take-off and landing), or
- exploit this new control device to reduce traditional control surfaces (canards, tailless).

Thrust vectoring may be available on most future aircraft as a baseline or as an option. Studies and flight tests are on the way for most programs currently under development (GRIPEN, F22, JSF, SU37 export), and one can suppose that a key concern is to determine the best possible trade-off between agility and stealth.

6.4.1.1. TOWARDS A CAREFREE HANDLING SYSTEM

Whatever the means used to obtain the airframe agility, the philosophy underlying the design of the flight control system may differ from one country or from one aircraft manufacturer to the other. Some aircraft provide good examples of an original control philosophy:

- Thrust vectoring independent control (HARRIER, SU37 TV). In aircraft such as the Harrier/AV8, the ability to independently vector thrust was designed primarily to achieve vertical or short take-off and landing performance (STOL). Subsequently, the ability to vector in forward flight was also demonstrated as a possible combat technique that provides rapid deceleration and extra lift [17]. However, the requirements for post stall manoeuvrability are quite different: pitch and yaw axis moments generation is then required, together with rapid response rates which make an integrated flight/propulsion system mandatory. The ability to engage and disengage thrust vectoring may be required in particular situations, such as degraded flight modes, but pilots are probably most likely to benefit from integrated, rather than independent, control when it is engaged. This is demonstrated for instance by the research programs conducted on the basis of the HARRIER aircraft experience, involving IFCS of thrust vectored aircraft [18].
- Departure-tolerant aerodynamic design (MiG 29, SU 35). The preferred philosophy among these particular designs is to allow the pilot to fly in the post stall region while being able to recover from the spin, rather than to build limiters into the flight control system [19]. The intent is to be able to use the entire envelope in combat and to teach the pilot how to recover from unstable situations (possibly with the help of an auto recovery system, as the panic button existing on the MiG 29 aircraft).

Having considered those particular designs, a general agreement is now that a system integrating flight and propulsion control is likely to bring substantial benefits in terms of safety and ease of use of the aircraft and also in terms of mission effectiveness.

Such a carefree handling system enables a limited number of controls (stick and throttle) to be used to manoeuvre the aircraft inside the whole flight envelope and automatically takes care of the aircraft limitations. For instance, once selected, operation of thrust vectoring is transparent with the flight control system dividing the required controls deflections between the thrust vectoring and conventional control surfaces, and the system possibly limiting the stick inputs so that the load factor never exceeds the aircraft's structural limits, given its current configuration. The carefree system may improve flight safety, as it makes it possible to avoid aircraft departure and loss of control in most flight conditions. Safety and flying accuracy can be further improved by implementation of advanced functions (see also 6.2 on Personnel Protection) such as:

- automatic recovery from unusual situations,
- ground proximity warning,
- obstacle and collision avoidance,
- exit gate and aided post stall termination, and
- optimized manoeuvres, e.g., for energy recovery.

Carefree handling makes it easier for the novice pilot to fly the aircraft. This is now a key advantage as the formation and training flight hours are reduced. Also, a side effect of the carefree control system is that the aircraft can be flown more aggressively, without any limitations on the control stick input.

On the other hand, expert pilots have a tendency to find it frustrating because their flying proficiency is not recognized as it used to be. Anyway, the pilot job in the future will obviously comprise more management/decision tasks than basic flying. As the basic flying workload is reduced, the pilot can better concentrate on the tactical decisions and actions. Carefree handling also supports spatial orientation and SA, as less attention is required to the primary flight information displays.

6.4.1.2. LESSONS LEARNED FROM THE X-31 EXPERIENCE

The X-31 program provides a good example of an integrated carefree flight control system: the design goal was to allow controlled flight and carefree manoeuvring at and beyond stall boundary, without any additional workload in the post stall region [20]. This is achieved by the use of three thrust-vector vanes, plus four trailing edges flaps and an all-moving canard. These control effectors were all integrated into an advanced flight control system.

The control law was designed to control the aircraft in the flight path axis system:

- load factor command up to 30° AOA and angle of attack command above 30° AOA
- velocity vector roll rate command (with zero side slip),
- side slip command (below 40° AOA).

The handling quality requirements consist of high pitch and velocity vector rates (pitch rate up to 25°/sec and velocity vector roll rate between 30 and 50°/sec in the PST - from 30° to 70° AOA) plus precise fine tracking for gun aiming.

These objectives can be quite conflicting because of the large angle of attack domain; they require a careful design of the control system and gains. For instance, the longitudinal stick sensitivity in the X-31 was so high that it was possible to command high AOA even when you really do not need it. This was corrected by the addition of a pilot selectable AOA limiter into the flight control software [21].

Also, a problem appear during the flight trials of the X-31, with the pilots hitting their legs with the stick when commanding high roll rates at high AOA. A scaled lateral stick command was implemented into the software to solve the problem.

Some possible alternatives to these problems may be to use special command devices or systems: long control stick used in the Russian aircraft, balanced force-feel system design [22], dedicated systems for specific tasks such as the GRIPEN automatic gun aiming system, and multi-mode control laws depending on the task/phase of flight, etc.

The X-31 control laws were designed to achieve zero side slip manoeuvres in PST. This design implies little Gy at the aircraft center of gravity and thus, small lateral accelerations are imposed to the pilot. Also, the normal load factor remains relatively low, because of the low airspeed in the post stall domain. High levels of +Gz may be attained only during the transient phase of increases in angle of attack and only for a short time duration. Some transition between Gz and Gx also exists when entering PST, but this was not perceived as painful or disorientating, as the aircraft quickly slowed down and the acceleration remained at moderate levels.

One possible problem of carefree handling may be the lack of sensory cues. Most of the conventional aircraft have some characteristics such as noise, buffet or wing rock, which inform the pilot where the aircraft's current status point is into the flight envelope. In the X-31, the sensory cues (buffet and stick force) are almost the same at 70° as they are at 12° AOA. This led most pilots to ask for a tone to provide them with AOA cueing. Some similar difficulties may exist with other key flight parameters (side slip angle, heading, flight path angle, speed and energy), especially under low visibility conditions. The problem may be more acute as airframe agility and PST relate to parameters which are not primarily monitored under conventional conditions; special displays and special training may be required for the pilot to monitor those parameters.

The various unpredicted obstacles discovered and eventually solved during the envelope expansion of the X-31 program suggest that the development of a totally carefree handling system is still questionable, because of the lack of theoretical methods to demonstrate the complete robustness of the handling system, especially under non conventional flight conditions. The only solution, currently applied when expanding the flight envelope of a new aircraft is to proceed with extensive flight tests, which are designed to be as exhaustive as possible given the program budget and time constraints.

6.4.1.3. OTHER CONCERNS ABOUT CAREFREE CONTROL SYSTEM

Another pilot concern about carefree control may appear when aircraft limits and aircraft coordination are handled automatically. The automation of the aircraft limits may have some drawbacks under emergency or combat circumstances which require the full use of the aircraft, but this problem is only the counterpart of the safety and mission effectiveness benefits, and the accurate design of the control laws makes it less and less sensitive.

More insidious may be the drawbacks of automation, also sometimes referred to as automation surprises; while developments in cockpit automation result in workload reduction and economical advantages, they also raise a special class of human-machine interaction problems [23] (see also 6.7.2).

These problems have been examined in research addressing the last generation glass-cockpit civilian transport aircraft. They involve confusion on the status of the automated control system and the subsequent behavior of the aircraft. The complexity of the control system is accompanied with a partial knowledge of the system; the pilot's knowledge is focused on the most frequently used automated modes, which may represent only a relatively small part of all the possible modes. A possible mismatch between the pilot's understanding of the system and the actual function performed by the system may occur under unusual conditions. Special training and pilot adaptation are the only compensation for an ill defined automated system and a poorly designed interface (see 7. Selection and Training).

Although a consensus exists that the pilot needs feedback on the complex aircraft system, special attention should be given to the level of feedback, i.e. the nature and the amount of information concerning the system functions that should be provided, displayed or made available to the pilot. The complexity of modern systems makes it obviously impossible and undesirable to display every item of information to the pilot, but a minimum level of information is certainly desirable to keep the pilot on line, so that decisions can be made when needed. For instance, information is probably required about the following points: which system functions are actually in control, what are the goals aimed by the system, what to do if a system function fails, and what to do once a goal is achieved.

Also, the level of information provided to the pilot may be context-dependent. For instance, the pilot doesn't always want feedback from the system when the feedback can be a distraction from the tactical situation. The precise determination of the level of information that is required and sufficient to achieve a mission is not possible today without practical experiments. The research studies about the processes underlying the building of SA could provide some guidelines for the design of future pilot/system interfaces and appropriate pilot aids. Alternative control technologies may also contribute to the enhancement of pilot-cockpit communication [24].

The recent approach and development of human-centered automation may help avoid these drawbacks. Nevertheless, the interaction of humans with complex systems is still a non-trivial problem, and the introduction of automation should be driven by actual operational needs rather than by marketing or economical considerations.

6.4.2. AGILE AIRCRAFT IMPLICATIONS ON HEAD UP CONTROLS AND DISPLAYS

6.4.2.1. HIGH ANGLE-OF-ATTACK

Before the advent of agile airframes, pilots could assume the aircraft was heading where it was pointed. Technological advancements, which now allow controlled flight above a 40 degree AOA, have changed all that. This is problematic in that conventional attitude displays can not simultaneously present both the nose position and vertical velocity during high AOA manoeuvring. Moreover, when a pilot is recovering from a high AOA manoeuvre (e.g., over 45 degrees), there is an initial feeling that the aircraft is not reducing its AOA in response to nose down pitch commands. This makes it even more difficult for the pilot to maintain awareness of the flight path vector [25]. HMDs will help keep the flight path vector within view, compared to conventional HUD presentations. However, for instances when the pilot is not looking in the direction of flight or when the aircraft is at an extreme angle (e.g., 60 degrees), a HMD is not the solution [14]. Pilots need a display format that provides a rapidly interpreted indication of the flight path response for agile aircraft.

6.4.2.2. NEW COMBAT MANOEUVRES

Agile airframes have enabled a new range of combat manoeuvres (e.g., yawed rotation about a vertical flight path down the "Fire pole" and climbing games such as the Herbst Manoeuvre or "J-Turn"), especially since pilots no longer have to point the nose of their aircraft in the direction of the target. The ability to rapidly change flight path has also allowed agile aircraft an advantage during flat scissors manoeuvres – two aircraft, usually close to one another and at a low

airspeed, running toward one another and reversing after overshooting their flight paths. This process is repeated until one aircraft can manoeuvre to achieve a firing solution. Agile aircraft, which can fly slower and roll at high rates have a definite advantage. These two exemplary manoeuvres present corresponding display challenges. First, the pilot must receive a clear indication of the approach of a “terminal exit time” – that point in flight when the pilot must leave the post stall domain to avoid reaching a hazardous altitude. Second, additional indication of yaw, in addition to flight path, is needed for the pilot to maintain spatial orientation. A visual reference that provides an accurate orientation cue is especially needed during automatic guns aiming or missile avoidance, to help avoid disorientation and sickness from the abrupt manoeuvre changes. Also, means of maintaining sight and SA of the target during a high AOA flight is required. For the scissors movement, for instance, it is easy to lose the target.

6.4.2.3. HIGH SPEED/EXPANDED WEAPON ENVELOPE

The anticipated speed that can be achieved by agile aircraft will mean that information in front of the pilot will unfold two to three times faster than in non-agile aircraft [25]. Thus, some conventional symbology (pitch ladder and digital readouts) may change too rapidly to be useful to the pilot. Alternative symbologies need to be explored. Also, electronic systems, which can sift through the torrent of incoming data and prioritize what information is displayed and what control actuations are available, are required. This is especially true, given the expanded weapon envelopes and the myriad of information requirements (e.g., launch volume boundaries, weapon firing status, and target priority, aspect, range, etc.). The pilot has to “think ahead” more, given there is less turning time involved in getting in position to launch weapons. These agile operations require decisions to be made in “microtime” or less time than one typically would want to spend weighing options, making decisions, and executing actions. The ability of the system to provide the right information at the right time, and assist the pilot in determining the right course of actions, is the crux of the cockpit designers’ challenge.

6.4.2.4. ENERGY MANAGEMENT

Given the complex manoeuvres possible with agile aircraft and anticipated use of carefree handling, the pilot needs to have precise timing and perception of any change in the aircraft’s energy state. Moreover, the pilot needs information pertinent to energy management to weigh the advantages of different manoeuvres that can be employed. For instance, the pilot needs information on the goodness of the launch condition to assess the tactical situation and determine whether to accept a low confidence launch or manoeuvre to a more favorable launch position. This is especially important since using the advantages of an agile airframe to point the nose at a target may leave the aircraft too slow to recover speed quickly for a missile defense manoeuvre. This is even more problematic if the velocity information displayed to the pilot is unreliable. Since most airspeed indicators currently employed are pneumatically driven and unreliable below the stall-speed, this is another critical concern.

6.4.2.5. HEAD UP INFORMATION REQUIREMENTS

Most of the information requirements for agile aircraft are the same as non-agile aircraft. For flight control, pilots need to know where the aircraft is actually going, rates of change, energy management, and how to recover to straight and level flight. Given the dynamic and expanded weapon envelopes realized by agile weapons, pilots will need enhanced estimations of the probability of detection and or launch as well as accurate information on the threat situation, ownship susceptibilities, and sensor ranges [26]. Information is also needed to assess avoidance manoeuvres and the use of decoys. The preceding paragraphs note some specific information requirements for agile flight. Additional information on candidate symbology is presented in 6.4.3.1.3.

6.4.2.6. HEAD UP CONTROL REQUIREMENTS

There are numerous control actions required in utilizing the weapons format presented head up. Likewise, there are controls which determine which formats are displayed, the level of detailed symbology (i.e., declutter functions), and a myriad of functions for sensors and data links (e.g., selecting radar range). The extent to which these control functions can be accomplished without looking down in the cockpit to select a specific switch, etc., the more the pilot can keep the head up. It is anticipated, though, that some control functions will remain assigned to head down manual controllers (e.g., weapons release). These will be discussed in 6.5.1.4.

6.4.2.7. HEAD UP TUNNELLING OF PILOTS’ ATTENTION

Presenting information on head up displays and providing controllers that can be employed with the head up, together with the demanding agile aircraft mission, can result in a tunneling or channeling of the pilot’s attention such that vital head down information is missed. Indeed, it is possible that the pilot’s attention can be focused on a particular head up display element, system, or task such that other critical head up data is missed. It cannot be assumed that pilots will scan all available information sources in a timely manner. Therefore, some cueing mechanism is required to inform pilots of critical information or a change in aircraft or mission state.

6.4.3. CANDIDATE HEAD UP CONTROLS AND DISPLAYS

Next some candidate head up controls and displays will be described. This presentation will focus on pilot usage of these devices for agile aircraft applications, rather than on the mechanics of each technology.

6.4.3.1. HELMET MOUNTED DISPLAY/TRACKER SYSTEMS (HMD/T)

Candidate HMD/T systems have three major components: 1) a head or helmet mounted visual display, visually directed, 2) a means of tracking head pointing direction (based on the assumption that the pilot is looking in the general direction that the head is pointing), and 3) a source of visual information which is dependent on the head viewing direction [27]. Information displayed on the HMD can be referenced to head axes, aircraft axes, earth axes, or any combination of these three. Advances in several display technologies (miniature cathode ray tubes, etc.), make HMDs a definite candidate for agile airframes [28]. With further research and development, other display hardware may provide additional advantages over conventional approaches. For instance, Saab Avionics in Sweden is exploring possible applications of the Virtual Retinal Display™ system developed by Microvision. This new display system scans a lower power beam of light to “paint” rows of pixels onto the retina of the eye, creating a high resolution, full motion image without the use of electronic screens [29].

The concept of HMD/T operation (Figure 1) is as follows: the pilot looks in a particular direction, the head tracker determines what the direction is, and the visual information source produces appropriate imagery to be viewed on the display by the pilot. The direction of the head can also be used as a control signal for a variety of aircraft systems, in addition to controlling what information is presented on the display. Thus, the HMD/T system serves as both a head up control *and* display, with an instantaneous FOV around 25-40 degrees subtended visual angle.

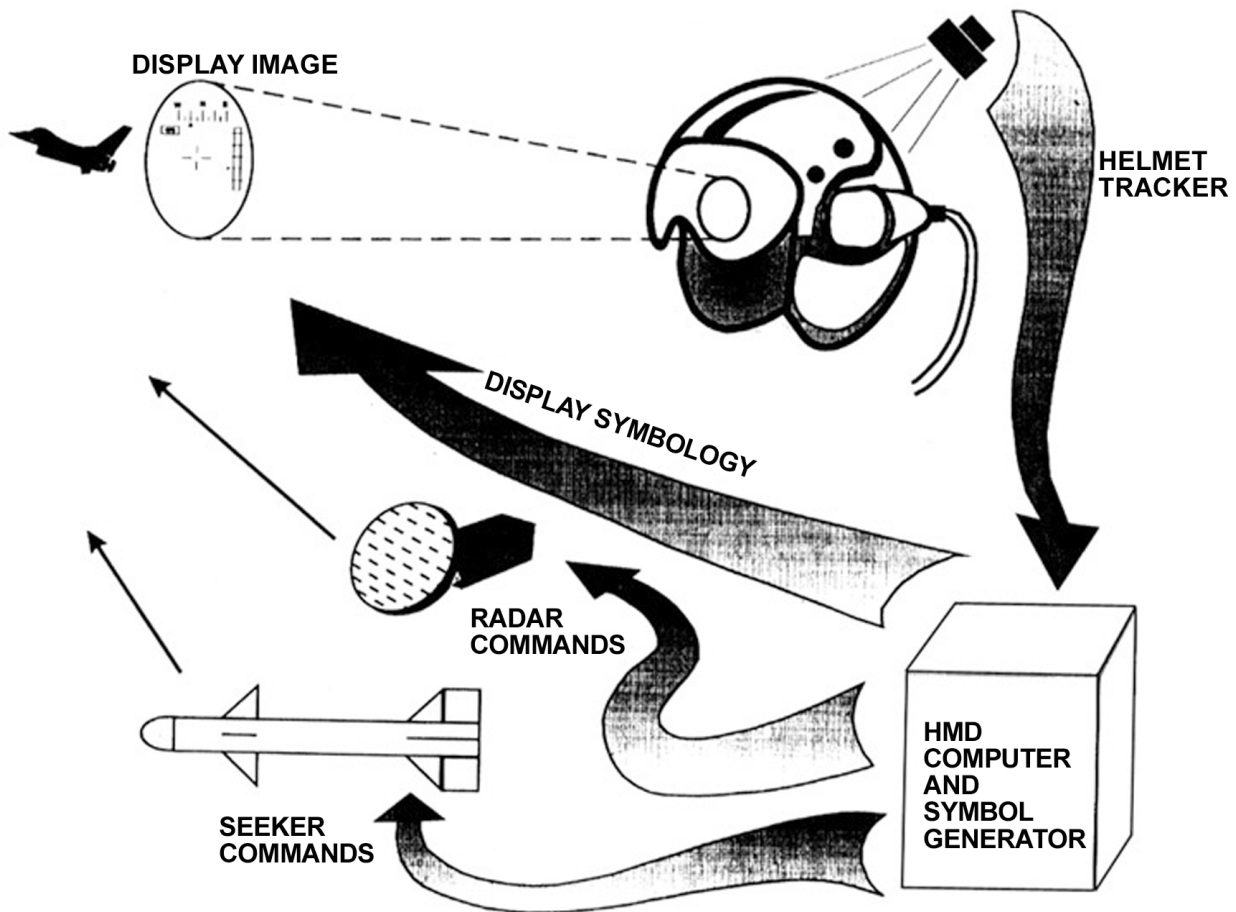

Figure 1. Schematic of Helmet Mounted Display/Tracker System Concept (Reprinted with permission from *Helmet-Mounted Displays and Sights*, by Mordekhai Velger. Artech House, Inc., Norwood, MA USA. www.artechhouse.com).

With a HMD, the pilot has a global view of information through the whole range of head positions [30]. Head up presentation of visually coupled information will assist agile aircraft pilots in looking out of the cockpit to maintain SA in a highly dynamic flight environment. For instance, research has shown that the off-boresight HMD enhances the pilot's search capability, tracking performance and survivability in a simulated low-level, high-speed airborne surveillance/reconnaissance mission [31] and facilitates high angle target search and intercept during a simulated A/A engagement [32]. With a HMD, both the duration of off-boresight visual scanning and the angle with which the pilot was able to scan the aerial environment were increased. The extent to which this advantage can be realized depends on the information presented on the HMD, as the symbology can occlude the outside world view to some extent. It is

important to present only the information required by the pilot for that flight segment. It is especially important to keep the central FOV unobstructed as much as possible during A/A combat.

For combat, the combination of agile aircraft and HMD/T systems may offer important tactical advantages when used in conjunction with guided missiles. A tracker determines the position of the pilot's head as the target is followed through the display on the helmet visor. The tracker relays critical information to the computer that, in turn, communicates the location of the target to the missile system. When the weapons lock on the target, the pilot receives feedback and then pulls the trigger located on the control stick to fire the missile. This scenario represents a total paradigm shift in the way within-visual range A/A combat is fought. The nose of the aircraft is no longer the sighting reference for cueing the weapon, but rather the pilot's helmet. As long as the target is within range and can be viewed by the pilot through the display in the helmet visor, the relative position of the aircraft to the enemy is not critical [33]. Since a hostile contact averages only 30 seconds to 2 minutes, any time saved by not needing to reposition the aircraft helps give a quicker first shot capability to pilots. This capability also facilitates engagement of multiple adversaries. Using a HMD/T system, a pilot can designate and launch a missile or lock the radar and immediately turn to the next target, designating sequentially several targets within seconds without having to reposition the aircraft [30].

Another advantage of a HMD/T system is the ability to designate targets and hand off their location to other sensors and the theater communications system, in general. For example, through the HMD/T, the pilot can steer a FLIR system mounted on a steerable gimbal in the nose of the aircraft. Likewise, a threat detected by a sensor can be used to cue the pilot by showing directional information to the threat location on the HMD. The pilot can also designate a ground position and then call up cues to reacquire the target, should the pilot lose sight of it during manoeuvring [30].

These potential tactical advantages were demonstrated in several simulated scenarios by operational F-15 pilots employing a HMD/T system in the McDonnell Douglas simulator domes [34]. The simulation pilots reported that the HMD/T: made it easier to accomplish within-visual range radar acquisition and get visual sighting of acquired targets, saved time in attacks, provided helpful weapon data while visually tracking a target, added tactics capability by easing simultaneous AIM-9 and AIM-7 attacks, and avoided sacrificing basic fighter manoeuvres to launch an AIM-9 or perform a full system gun attack. The ability to accomplish a visual missile attack without sacrificing positional advantage was viewed a key advantage of the HMD/T. The pilots commented that the HMD/T provided as many improvements to A/A operations as weapons computers have provided to A/G operations. These opinions were reflected in the quantitative data measured after the pilots became familiar with the prototype. There was also a marked exchange ratio advantage for the pilots with the HMD/T.

6.4.3.1.1. Visual Illusions with HMD/T Systems

Certain vision conditions (empty field myopia and accommodation convergence micropsia) can be problematic with HMD/T usage [35]. For example, even if symbology is presented on a HMD focused at infinity, overlaying the sky, some individuals' eyes will tend to focus two feet out from the display. Problems such as this can result in misjudgments of sizes and distances to external objects (e.g., other aircraft). The symbology needs to be designed to minimize such visual illusions.

6.4.3.1.2. HMD/T Symbology Size

The size of symbology presented needs to be optimized for the HUD FOV viewing and the goal of minimizing obstruction of the outside world view. Plus, the resolution of the HMD will impact the size and legibility of presented text and symbols. One study [36] has shown that recognition of symbolic aircraft presented on a collimated display deteriorated with increased eccentricity (5, 9, and 13 degrees). Aircraft in the periphery had to be displayed for a longer time than targets near the fixation axis, for viewers to classify them successfully. Response latencies were also longer in the lower and left visual fields.

6.4.3.1.3. HMD/T Symbology Format

Advances in display technologies make it possible to present pilots with formats that span from simple lines and symbols to high fidelity, geo-specific perspective scenes. Furthermore, visualization systems which fuse multiple sources of sensor inputs and other data can present predictions of ownship flight path and threat situation dynamics, allowing pilots to extend their understanding of the present situation [37].

Having the HMD format attempt to duplicate the organization and content of the real world is attractive in the sense that the pilot would have *everything* needed. Besides an electronic representation of the terrain (for use in limited visibility conditions), waypoints, targets, position and state of weapons, threats, and threat status can be depicted (Figure 2). The optical flow of objects could give natural cues as to altitude, attitude, and airspeed [38]. For conditions in which view of the outside scene is poor or absent, such a display can provide a "virtual cockpit." For this application, all the head down displays can also be projected whenever the pilot looks at the location where these display would have been [30].

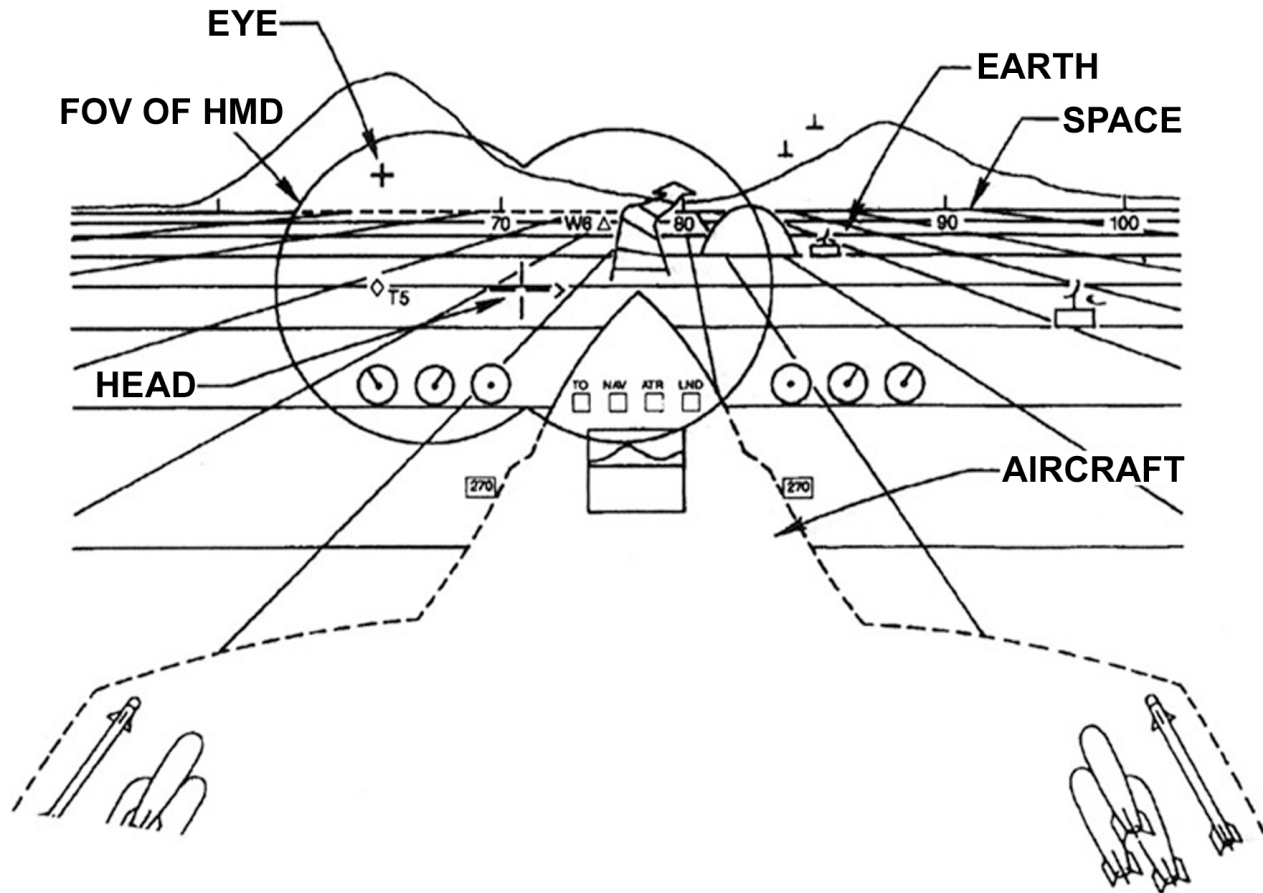

Figure 2. Example Candidate HMD Symbology [27].

For flights where the outside scene is visible, it remains to be determined whether providing this abundant amount of information is in the agile aircraft pilot's best interests. It is important to remember that any symbol used on the HMD overlies the outside scene, thus obscuring outside elements. Contrary to viewing a HUD, pilots viewing a HMD cannot shift their heads to look around the display to get a better view of the scene – the symbology remains constantly in front of the pilot's eye.

For any proposed format, systematic evaluations of candidate symbology sets are required. These evaluations should start by examining features of individual symbology elements. Indeed, experience has shown that the usefulness of elements depends on the pilot's current flight segment and information needs. For example, consider the use of digital, tape, and dial indicators of flight parameters. Some research has indicated that analogue displays are easier to process than digital displays since the analog information is extracted more intuitively, maps more directly on the response system (i.e., analog control inputs), and requires few mental transformations [39]. Moreover, if the digits (e.g., altitude, vertical velocity, sink rate, or heading) are changing very rapidly, the blurry readout is useless, especially for those instances where the pilot only needs to have a general indication of the rate and extent of change. It may be the case that a dial format (e.g., with arc scribing the outside of the altitude dial relative to changes in vertical velocity) is assimilated more easily than vertical formats [40]; however, initial results using a HMD presentation failed to support this notion [41]. With a perspective format, quantitative estimates are even more difficult to discern and adding scaled reference marks as a remedy tends to defeat the objective of providing the pilot the impression of flying into the perspective scene [42].

Besides the requirement to evaluate how flight parameter information should be presented for agile aircraft operation, the unique information needs for these missions also needs to be considered. For instance, pilots will need to monitor the more extreme angles-of-attack that can be achieved by agile aircraft. It remains to be determined whether conventional digital and/or tape readouts are sufficient or if new symbology would be useful. One candidate HMD symbology set evaluated for the X-31 utilized two triangles, superimposed and appearing as one triangle for 0-30 degrees of AOA (Figure 3). For 30-70 degrees AOA, one triangle stayed fixed and the second grew to match a point on a scale inside the attitude reference symbology. Subsequent evaluation indicated that the tic marks were difficult to read on the scale and that demarcations should only be made for 30, 50, and 70 degrees [43].

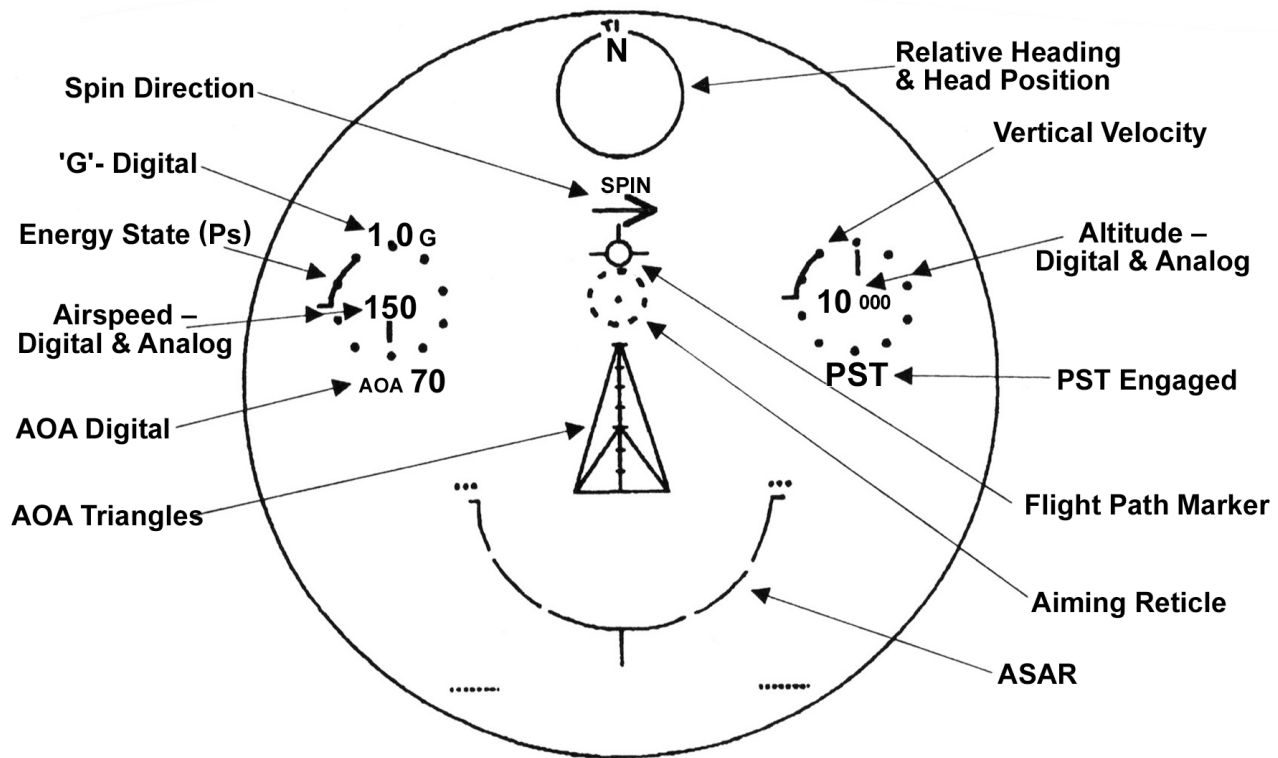

Figure 3. Example of Candidate Symbology for Angle-of-Attack [43].

There have also been several evaluations to determine what symbology helps exploit the advantages afforded by using a combination of HMD/T devices and precision weapons. One experiment investigated how the target location information should be related to the pilot [44]. Three symbology orientations were evaluated. In one, the symbology was relative to the nose of the aircraft (world coordinate system), indicating the most efficient pursuit vector between the ownship and an airborne target location. A second orientation referenced head movement (ownship coordinate system), indicating the most efficient line between the pilot's line-of-sight and a target. The third orientation evaluated included symbology that simultaneously presented ownship and head information. The results indicated that the ownship coordinate information may have more merit than traditionally believed and that pilots favored the combination (multiple coordinate reference frame) which presented both "look-to" and "fly-to" locator lines when the target was outside of the HMD FOV. A follow-on experiment examined how the angular distance between the pilot's line-of-sight and the target location should be depicted to provide look-to information [45].

Consideration of HMD symbology with respect to weapons needs to consider the exact flight mission anticipated, as information needs may differ depending on whether the pilot is engaged in A/A combat, A/G attacks, or missile evasion (in addition to navigation and approach to land piloting tasks). The designer's objective is to provide the information required for each flight segment, yet minimize the pilots' training burden by keeping symbology sets as similar as possible. For example, candidate symbology sets for A/A and A/G evaluated for the U.S. Navy both employed "caged symbols" to represent targets being tracked with the sensors, but beyond the display FOV [46]. For A/A missions, caged symbols were presented along the edge of the display FOV at the proper azimuth and elevation extrapolation and additional symbology features were employed to convey basic identification information and changes in target state (e.g., coding to indicate target affiliation and numbers to indicate target's order in shoot list). The display for A/G only differed from the A/A equivalents in the symbology used to represent the targets.

There may, however, be instances where information is not required in one segment, compared to another. For instance, there have been several studies addressing how and when ownship information should be presented. For example, one experiment [32] examined if ownship status information within the HMD symbology set is necessary for A/A applications. Several ownship status formats were evaluated, including the Standard Attitude Reference, the Arc Segmented Attitude Reference (ASAR) and the Theta Attitude/Direction Indicator (Theta). In the standard format developed by the U.S. Air Force, the attitude set includes a helmet fixed inverted "T" climb/dive symbol oriented as an inside-out flight path reference, as well as an artificial horizon line and pitch bars.

The German-developed ASAR (“orange peel”) includes a fixed climb-dive symbol (inverted “T”) that represents climb/dive angle by its relation to a half-circle arc surrounding the symbol [47]. The upper portion of the circle is invisible during straight and level flight. The visible portion of the circle represents the area below the horizon and the invisible portion represents the area above the horizon. The amount of visible orange peel translates to aircraft pitch (e.g., for positive pitch attitudes less than half the circle is visible, while for negative pitch attitudes more than half is visible). As the climb angle increases, the visible negative angle area of the arc begins to narrow in proportion to the climb angle. With an increase in dive angle, the arc closes to form a more complete circle (Figure 4). At a 90-degree dive angle, the arc forms nearly a complete circle, leaving a small gap to cue the pilot of the most efficient direction to recover from the dive. During a roll, the arc rotates about the climb-dive symbol.

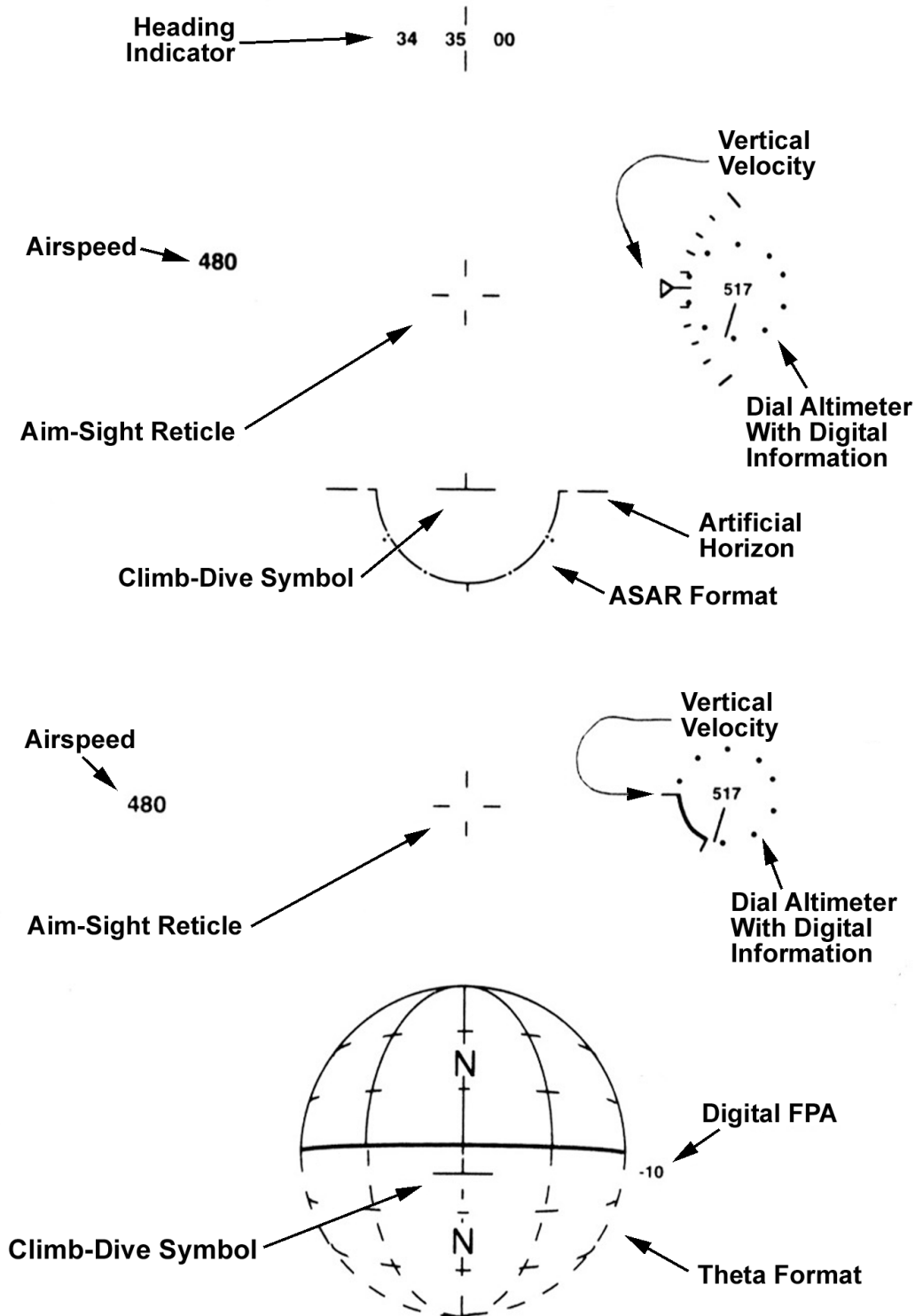

Figure 4. Example of ASAR (top) and Theta (bottom) Symbology [41].

Another format featured a Theta Attitude/Direction Indicator (Theta Ball) [47] developed at the AFRL (Figure 4). The symbology integrates heading information and attitude symbology with a simulated three-dimensional, transparent, wire-frame half-ball consisting of arced lines. The longitudinal lines serve as an azimuth (heading) position reference in 45-degree increments. The ball is free to rotate about all three of its axes to represent rotation of the aircraft in those axes. Continuous lines on the upper portion and segmented lines on the lower portion represent climb and dive areas, respectively. Within the ball there is a climb/dive symbol and the cardinal headings are marked by letters. The format is mechanized like a standard, three-axis attitude direction indicator ball.

The results of this experiment failed to show any interpretation or usability differences among the symbology formats used to present ownship information. However, the pilots definitely preferred that ownship status be included in the HMD symbology set [32].

Another study specifically examined an ASAR symbology suite versus a Theta symbology suite for a HMD used in the X-31 [37]. The pilots commented that for close-in-combat, attitude symbology was less critical, because the pilot flies relative to the opponent aircraft. Pilots found the ASAR useful as a large amplitude pitch reference for locating the horizon or recovering from an unusual attitude. This symbology is very compelling and effective for simple, instant instruction. However, they questioned its utility as a precision instrument. The Theta symbology was found easy to interpret and was the preferred attitude reference. The globe provided a good analysis of the situation. However, its utility in acute, complex, and difficult scenarios remains to be determined.

In a more recent effort at the AFRL, a “non-distributed flight reference symbology” was designed to supplement HMD target acquisition information with ownship status information, the latter particularly useful during high off-boresight targeting tasks [48]. The key challenge was to ensure the presented information is useful without any associated clutter or disorientation incurred by its presence. Following a set of design principles which were derived from empirical research and flight test feedback [49], this non-distributed flight reference symbol set presents ownship aircraft reference information close together and positioned within attitude symbology (see Figure 5). The primary flight information is spatially arranged so that the conventional basic “T” layout is maintained with airspeed to the left of altitude and heading between airspeed and altitude. The information is presented digitally inside an outline designed to mimic the shape of aircraft wings and tail. Collectively, this compact information montage can be located anywhere in the HMD FOV (e.g., near the bottom when it is desirable to declutter the upper area of the display so that target information is not occluded during A/A applications).

The aircraft symbol is fixed relative to the HMD FOV and the attitude symbology moves about it. The flight path angle and roll of the ownship montage is represented by its relation to a half circle arc (using the ASAR approach described earlier). During straight and level flight, the upper, or above-horizon half of the circle is not drawn. The visible lower half represents the area below the horizon. As the climb angle increases, the negative angle area of the arc begins to narrow in proportion to the climb/dive angle. Conversely, with an increase in dive angle, the arc closes to form a more complete circle and includes a marker to indicate the direction of the closest horizon. Heading tags appear at extreme climb and dive angle (e.g., 80 degrees or greater) to give additional indication of ownship roll. This functionality was found useful in previous evaluations of the Theta attitude reference symbology and helps provide orientation information throughout the full aircraft-manoeuvring envelope. During rolling manoeuvres, the arc and artificial horizon rotate about the ownship symbol. The display is mechanized so the attitude information is flight path-based, compressed, and forward referenced.

Evaluations are needed to evaluate this and other candidate HMD symbology formats to determine if a new design produces performance benefits that justify the cost of its implementation. In regards to ownship information, specifically the following need to be examined [50]:

- Symbol Compression Ratio (SCR; ratio of the angle represented by the symbol to the symbol’s subtended visual angle; relates to sensitivity or dynamics of the symbology),
- frame of reference (line-of-sight versus forward),
- pilot’s perspective, and
- axis separation (consistent and inconsistent; extent the first three features are applied to the various axes of the ownship attitude display).

“Pilot perspective” refers to the reference frame used to present attitude information to the pilot. Two major display concepts are commonly referred to as inside-out or “pilot’s view” versus outside-in or “God’s view.” Typically, inside-out displays are viewed more appropriate for precise flight control and outside-in displays more appropriate for navigation and landing tasks. However, some research has demonstrated that an outside-in format is superior for unusual-attitude recovery in novices or pilots trained on both formats [51]. In fact, pilots have noted that traditional

aircraft-referenced inside-out attitude displays are more difficult to interpret when the head is moved off-axis [52]. Even a small (7.5 degree) cockpit display that presents a periscopic image of the outside world can minimize roll-reversals [53].

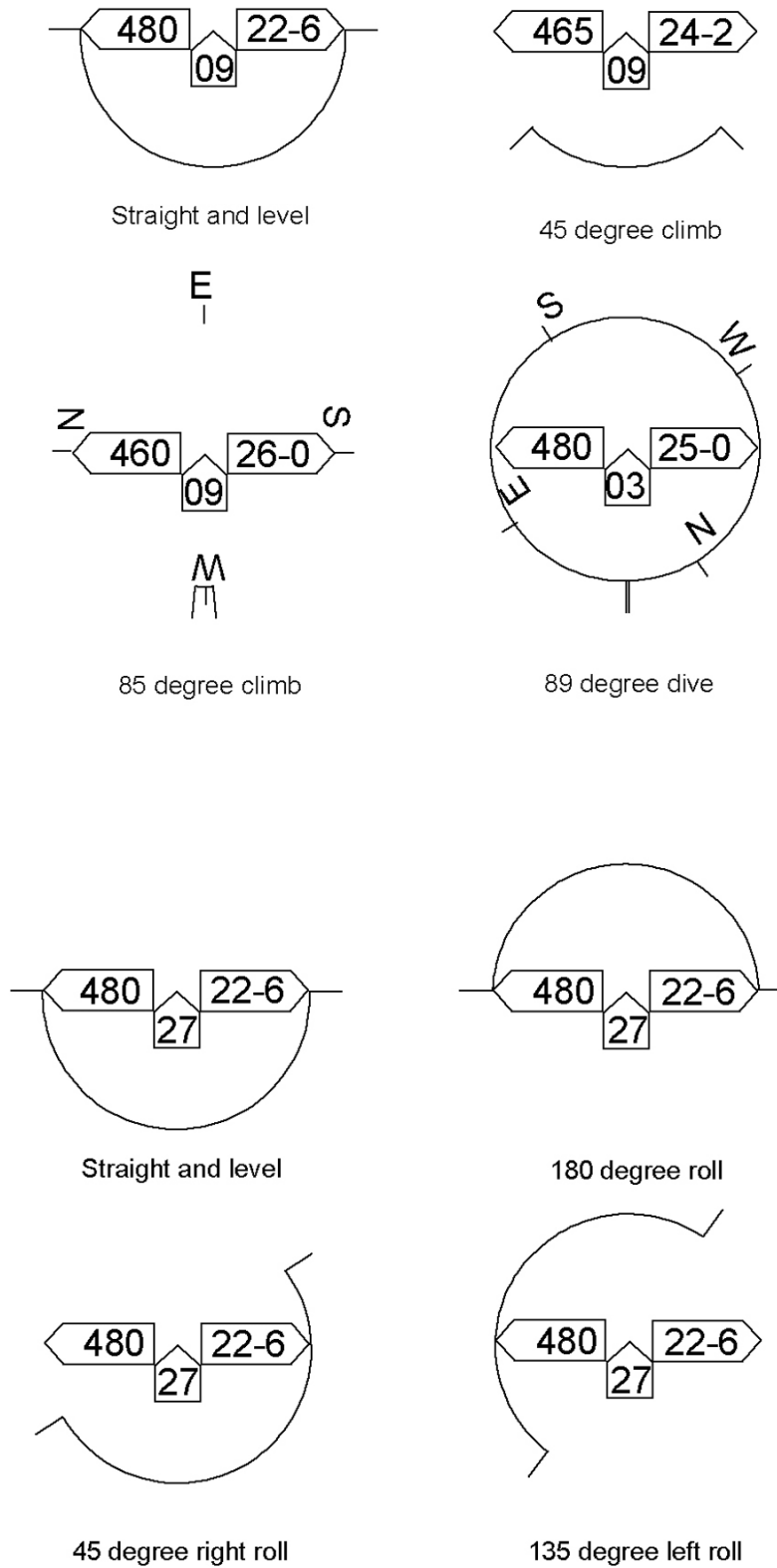

Figure 5. Non-Distributed Flight Reference Candidate Symbol Set with modified ASAR attitude symbology during: various climb and dive angles and roll manoeuvring [48].

These evaluations will help provide an understanding of the role of each of these aspects in designing a useful HMD format. For example, one complex format envisioned for a HMD that has a large instantaneous FOV, would have multiple cueing symbols. One aiming symbol would be in the upper portion of the HMD for designating aiming points outside the aircraft and another aiming symbol would be in the lower portion of the display to designate space stabilized electronic cockpit switches and functions [27]. The position of the cockpit switches imaged on the HMD stays fixed with respect to the cockpit, while the lower reticle moves with the changing head position. When the lower reticle is placed over the electronic cockpit switch, its visual form changes to indicate it is active and is being designated by head position. The pilot must then give a consent response by activating a single standard switch located on one of the primary manual controllers (e.g., joystick) or by issuing a standardized verbal command. Meanwhile, the upper aiming reticle remains active for designating outside world targets through other electronic control loops. Although it appears that this envisioned format would provide pilots with enormous display and control capabilities, there are numerous ergonomics issues that need to be examined before these anticipated advantages can be realized.

It is only through systematic evaluation of candidate symbology sets for specific flight tasks that optimal HMD symbology and formats can be identified. Unfortunately, a format found to quickly provide pilots with an overall SA and orientation perspective, may not provide the information required to precisely control the aircraft through a commanded mission. Also, the ideal format may depend on environmental factors, ground detail, and the availability of an outside reference. Although, current display hardware facilitates reconfiguring displays and formats, there is a limit to the degree to which switching between formats is beneficial. In sum, the cockpit designer has a large tool kit of display technologies to utilize. The challenge is choosing the best display format, such that the pilot is presented the right data, in the right place, at the right time. It is anticipated that near term HMD/T symbology sets will be based on the formats used in current jet fighters, with minor revisions. In this manner, less pilot training will be required and the more novel control and display approaches (described below) can benefit from additional development and evaluation.

6.4.3.1.4. Pictorial Portrayal of Information in HMD/T Systems

Symbols and alphanumerics presented in display formats depicting status of the aircraft or aircraft systems can be viewed as individual chunks of information that must be perceived and cognitively integrated by the pilot. Humans are limited as to the number of information chunks that can be managed at a time (e.g., the “five, plus or minus two” rule of thumb [54]). Advances in the generation of display graphics enable pictorial portrayal of information that groups individual pieces of information into fewer chunks. Theoretically, the pilot’s workload can be reduced with this approach because the processing required to chunk the information has already been accomplished [55]. Rather than spending time integrating the information into a status message, the pilot can more rapidly acquire the message (assuming the pictorial is easy to interpret) and then can devote time executing the appropriate response to the message.

For HMD formats, the most popular pictorial presentation entertained is a three-dimensional perspective path to assist the pilot in flight control. This format is discussed in 6.4.3.1.5 below. Pictorial formats occupy more display area than conventional formats. Given the limited FOV of the HMD and a desire to minimize the extent to which symbology interferes with the pilot’s outside view, the added value of pictorial formats for HMDs needs to be verified.

6.4.3.1.5. Use of Stereopsis Cues in HMD/T Systems

Stereopsis or stereoscopic vision results from the fusion of two slightly different views of the external world that our laterally displaced eyes receive. To present stereoscopic head up images, binocular HMDs are utilized so that a slightly different image is presented to the right eye from that presented to the left eye. Although retinal disparity allows the pilots to perceive depth stereoscopically, sometimes distortion in binocular HMDs can lead to misperceptions or perceptual problems (e.g., binocular rivalry and monocular suppression). The HMD system must be carefully designed to minimize magnification differences between the right and left images, rotation of the left and right optics relative to each other and misalignment of the left and right optic axis with respect to each other [56].

The introduction of true depth cues via stereopsis techniques in HMDs offers a means of further enhancing pictorial displays, particularly in improving the perception of pictorial layouts. For example, in one candidate format a range marker element (waterline symbol) provides a non-stereo cue in that when the lead aircraft is at the desired range, the wingspan of the aircraft symbol is the same width as the ownship symbol (the desired range marker). Inclusion of stereo depth cues with this symbology was found to improve performance by 18% in a simulation evaluation [57].

Probably the most entertained cockpit application of this technology, is to provide the pilot with a three-dimensional “pathway-in-the-sky” which integrates all relevant information into a single display and the pilot’s task is reduced to simply following the path (Figure 6). With the current accuracy afforded by Global Positioning and vast digital terrain data bases, the pathway-in-the-sky visualization concept is even more obtainable. In all three example flight path display formats depicted in Figure 6, the pilot’s task requires guiding the aircraft through the center of the channel to accurately stay on course. Each of the channels extends into the distance so the upcoming changes in the path can be anticipated. In the channel depicted at the bottom of Figure 6, the aircraft is a stationary symbol and the channel moves about it with changes in lateral and vertical direction. The aircraft symbol can be augmented with a dashed line path

predictor – each dash representing a time period of 10 seconds, indicating future aircraft position 10, 20, 30 and 40 seconds later if the aircraft were to maintain present flight conditions. This channel configuration depicts the aircraft to be slightly to the right of command path, but flying the command altitude. The aircraft is heading slightly to the left, as indicated by the path predictor. An option exists for various elements of information (threat symbols, numerical

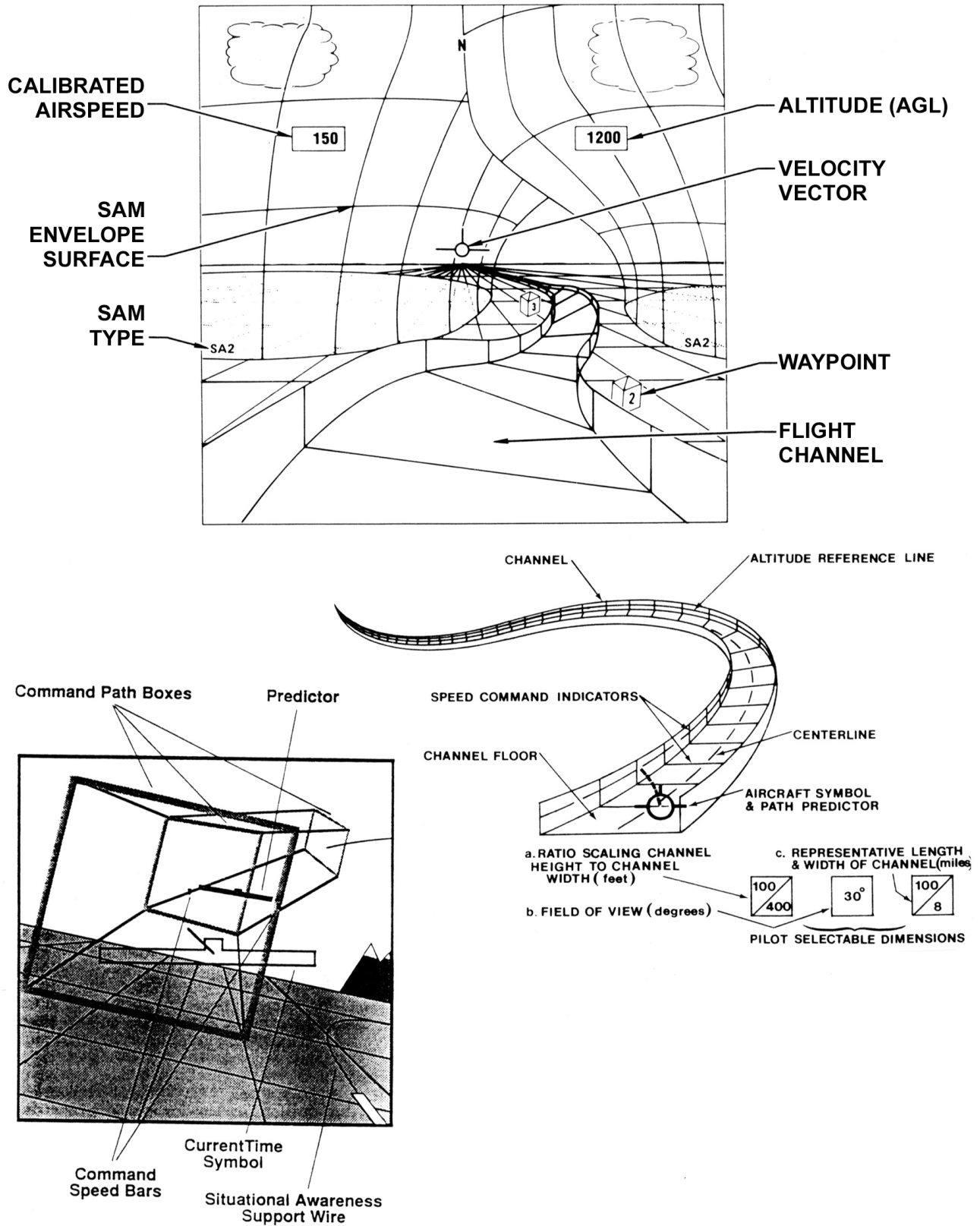

Figure 6. Examples of Pictorial Pathway-in-the-Sky Flight Display Formats [58,59,60].

readout, scales, etc.) to be selectively displayed or eliminated from the format. Of course during combat, the dynamics of the manoeuvres make using a path-type format as a command display less appropriate. However, such a display could be very useful for: 1) providing predictive information to the pilot – illustrating the endpoint if the aircraft continues in its current flight path, and 2) providing short term command information to execute a pilot-selected stereotypical manoeuvre (e.g., scissors manoeuvre). In considering these channel displays for agile aircraft, there is a body of relevant research. Researchers have found that three-dimensional tunnels where the viewpoint of the display corresponds to the position of the pilot (i.e., fully egocentric) are superior for flight path control, particularly for flying curved paths [42, 60]. Subjects found the channel display intuitive and to provide quick and simple orientation. Integrating information pertaining to the aircraft's vertical situation, horizontal situation and profile situation also relieves the pilot from scanning multiple displays to acquire the same information. However, such a display reduces SA due to its narrow FOV, making it difficult for the pilot to be aware of hazards in the surrounding airspace. If the FOV is increased, however, valuable display real estate is consumed or a distortion occurs as real space is compressed. This, in turn, also disrupts SA, increasing the ambiguity of where things are in space. The resolution of predictor information in the display is already less, since the perspective presentation means a reduction of size for objects far away. Moreover, it is difficult to get sufficient quantitative information, unless additional scaled reference markers and readouts are added. These items, though, lessen the natural impression of flying through the channel [42]. In an experiment evaluating a three-dimensional perspective flight display compared to multiple two-dimensional planar displays, measures for flight performance and SA were worse for the perspective display. The subjects commented that the key problem with the three-dimensional format was the ambiguity in depth judgement along the line-of-sight that the perspective display caused when the aircraft was approaching landmarks [61]. These ambiguities introduced by perspective views are the main drawback to their utility in agile aircraft – it is difficult to determine the absolute distance of an object because the pilot's viewing angle of the scene also changes the relative compression and expansion of the y (elevation) and z (distance) axes.

A more near term application of stereopsis cueing for agile aircraft is to present different categories or classes of information at different levels in depth [62]. With this application, only a few levels in depth are needed and there is no requirement that they accurately represent a certain dimension in depth. Use of three-dimensional presentations on HMDs helps declutter information and enables the pilot to more efficiently switch attention between different information classes. For instance, the altitude, heading and airspeed indicators could appear on a different plane from the aircraft symbol [62]. As one pilot interviewed commented, if information can be positioned at different depth levels, much more information can be presented on the HMD. Of course, research would be required to determine the optimal assignment of information to depth levels – whether it would be assigned by information class (flight, weapon status, threat status, etc.), priority, flight segment, or some other combination. Another possibility is to have the coding pilot selectable, the pilot preprogramming a default assignment before take-off.

6.4.3.1.6. Use of Color in HMD/T Systems

Assuming that the image source for a HMD can provide sufficient brightness, chromaticity and contrast to make colors visible under high ambient illumination conditions, use of color in display formats with discrete elements (symbols or alphanumerics) can make information uptake easier and faster [63]. For instance, color coding can be used to facilitate discrimination of information categories: indicate static versus dynamic, qualitative versus quantitative, incorrect versus correct, or designate information about to change or in the process of changing [64]. Another example pertains to pathway-in-the-sky formats; color could be used to differentiate a commanded path versus the aircraft's current path or the inside versus outside of the channel. A more traditional application of color in flight displays is using blue (denoting upward, sky direction) and brown (denoting downward, ground direction) appropriately so that it is obvious when the aircraft is flying upright versus inverted.

A more near term application of color is more likely in the pitch ladder symbology. Monochrome coding has already been applied in conventional formats to help reduce ambiguity between the positive and negative pitch bars and facilitate recovery from unusual attitudes. This has included changing the asymmetry between the bottom and top halves of the pitch ladder, and using different shape coding for negative (bendy) and positive (tapered) bars. Color coding the pitch ladder (positive bars blue, negative bars brown) has been found to be beneficial in simulations, especially when used in conjunction with shape coding [65].

Application of color (red and green) to help code target location, tracking, and weapons deployment was examined in a simulation of off-boresight weapon aiming [66]. Overall, the pilots preferred the color-coded symbology to the monochrome baseline. Furthermore, a “red means shoot” color-coding strategy (involving a progression from green to red as an indication of shoot-criteria satisfaction) was preferred over a “green means go” strategy (progression from red to green). In a subsequent study, the “red means shoot” coding was systematically compared to a monochrome baseline HMD symbology in an A/A simulated weapon delivery scenario. Results showed the “red means shoot” symbology produced significantly faster shots without degrading the probability of kill [67].

Any application of color in agile aircraft should be aware of the results of an initial evaluation showing sequential changes in color perception during relaxed, gradual onset of Gz acceleration [68]. The effects occurred at 4 Gz and the first hue shift was a disappearance of light blue into white, indicating that use of light blue on a light background may be problematic during a high Gz turn. The second shift was green to yellow. Thus, use of green and yellow to code classes of threats on a display may be confusing. Such findings support formats that employ redundant (e.g., color and shape) coding.

6.4.3.2. EYE-BASED CONTROL

The next plausible extension of the capabilities of HMD/T systems is the integration of eye tracking to enable control of crew station functions using the pilot's eye line-of-sight [69]. In that the visual system is the primary channel for acquiring information and eye muscles are extremely fast and respond more quickly than most other muscles, it is advantageous to have the direction of eye gaze serve as a control input. In other words, if the pilot is looking at a target, it is more efficient to use the pilot's gaze to aim a weapon, rather than align the head or manually slew a displayed cursor over the target. In this manner, eye-based control can increase the envelope and speed of target acquisition with a HMD/T system. Line-of-sight cueing between pilots can also be facilitated by eye designation of points of interests. The pilots briefing the Working Group were very positive as to the increased capability that could be realized by pointing the eye, rather than the head, to execute control functions. Moreover, eye motion is more feasible under high acceleration conditions, compared to head or hand movement [70].

For eye-based control to be useful, however, it is important that the pilot's eye movements remain natural and not involve any unusual blinking or lengthy fixations. Eye-based control is similar to operating a computer mouse in the sense that gaze position indicates the position or response option on a display, and some method analogous to a mouse button press is used to trigger the response [71]. Without the additional consent response, a "Midas touch" problem could occur, with commands activating wherever the pilot looks [72]. Different types of consent responses have been evaluated [73] and it is recommended that a dedicated, conveniently located button (e.g., on the joystick) be employed as a universal consent response. If the pilot's gaze is only being utilized to call up additional data for eye designated icons, then perhaps only a short fixation is sufficient, without a consent response [72]. In this manner, the pilot's sequential review of a series of targets can be made more rapidly, with detailed information popping up, as the gaze briefly pauses on each target.

The more accurate eye trackers calculate gaze direction through image processing of one or more features that can be optically detected on the eye. Typically, these features are reflections from an infrared source directed at the eye. Although current eye tracking systems are not flight worthy for agile aircraft applications, numerous efforts are underway to explore how eye tracking optics might be integrated into HMD systems and methods for easing tracker calibration and maintaining eye track under varying illumination conditions. It is anticipated that eye-based control will eventually be feasible for agile aircraft and be used to designate display areas subtending approximately 1 degree of visual angle (by fixating 50-100 milliseconds) [74]. Designation of very small targets may be problematic; however, there are several techniques the designer can employ to aid in the gaze-based selection of densely packed targets [44,71]. Improvement in eye tracking technology will also be required to enable eye-based control at more extreme "look angles" (e.g., +40 degrees azimuth and elevation).

6.4.3.3. ELECTROMYOGRAPHIC (EMG)-BASED CONTROL

It is feasible to modify the hardware or helmet housing a HMD/T system, or the pilot's oxygen mask, to position electrodes on the surface of the skin which detect the asynchronous firing of hundreds of groups of muscle fibers. These electrical signals that accompany muscle contractions, rather than the movement produced by these contractions, can be used to provide EMG-based control. Most commonly, these electrical signals are compared to some threshold value to derive a binary control input – above threshold initiates one control action, below threshold initiates another [75]. Considerable development is still required to optimize the signals employed, assess the stability of electrode contact over time, and minimize the effect of operator movement and external electrical activity on signal recordings. However, EMG-based control is a far-term candidate head up controller that enables the pilot to make discrete responses without using the hands. To implement EMG-based control, it is important to choose a body movement that does not interfere with the pilot's normal functions, is not likely to be made during normal task activity or in response to acceleration loading, and can be implemented in such a fashion that the system can discriminate a purposeful EMG input from an inadvertent one. To date, subtle/slight eyebrow lifts and jaw clenches have been successfully used in concept demonstrations as enter and tab functions on a computer task. However, these simulations targeted ground-based tasks and the results may not be applicable to agile aircraft cockpit controls.

6.4.3.4. ELECTROENCEPHALOGRAPHIC (EEG)-BASED CONTROL

Electrodes integrated into the pilot's headgear positioned over specific areas of the scalp can provide the necessary signals to implement EEG-based control. This type of control translates the electrical activity of the brain into a control signal. In one approach, EEG patterns are brought under conscious voluntary control with training and biofeedback [76]. This approach is not appropriate at this time for the agile aircraft pilot because of the significant training

investment. A more applicable approach harnesses naturally occurring brain rhythms, patterns, and responses that correspond to human sensory processing, cognitive activity or motor control. The most plausible method to date uses brain responses to modulated stimuli [77]. These brain responses include components that modulate at the same frequency as the evoking stimuli. Thus, if selectable items of a display are modulated at different frequencies, the pilot's choice between selectable items can be identified by detecting which frequency pattern is dominant in the visual evoked brain activity. The pilot gazes on the desired selection and the controller registers the corresponding frequency of the displayed item. In effect, through EEG-based control, the advantages of eye gaze-based control can be realized without expensive and obtrusive hardware components.

Optimization of this head up control requires minimizing the time required for signal processing, developing easily donned electrodes, and minimizing the distraction produced by modulating (flashing) display items. It is this last factor which is key to agile aircraft operation. One potential solution is to modulate display items at a sufficiently high frequency such that the pilot does not perceive the flashing. Research is underway to investigate whether the brain responses produced by high-frequency modulated stimuli are adequate for implementing EEG-based control [78].

6.4.3.5. SPEECH-BASED CONTROL

Speech recognition technology allows the pilot's speech signals to be used to carry out preset activities. Upon detection and recognition of a sound or string of sounds, the recognizer can be programmed to execute a predetermined action (e.g., allocate missiles to targets, change navigation route and radio frequency, alter displays, control radar, etc.). Until recently, the key obstacle for using speech-based control in cockpits, was the impact of several environmental factors on the performance of speech recognizers. One factor is high ambient noise levels, under which the speech input changes in amplitude, duration and vocal pitch. Vibration leads to warbling in speech sound and breathing irregularities. When the speaker is in excess of 6 G, there are variations in the speech signal (increased energy, pitch, and format frequency locations) due to displacement of the vocal tract and changes in the breathing rate; "intelligible" speech, although, can be produced up to 9 G. The stress level of the pilot can also influence the speech signal. To compensate for these shifts in speech due to changes in the environment, adaptation algorithms are required in the speech processing, as well as noise canceling techniques [79]. Recent technological advancements, however, have produced robust commercial speech recognition systems that are capable of operating in high noise/mid G operational cockpit environments that also require oxygen masks. For example, in an OV-10 flight test conducted by the AFRL, speech recognition accuracy was above 97% for all conditions, including continuous 3-G turns. The results also indicated that accuracy as high as 99% is attainable with commercial speech systems at noise levels as high as 120 dBA [80].

Thus, the question is not whether or not agile aircraft will have speech-based control, but rather *how* will it be employed in the pilot-vehicle interface. Design factors that influence the utility of speech recognizers include: acoustic similarity of commands, length of words (longer are better), microphone placement, consistency of the speaker's speech, vocabulary size, and the extent to which the order of commands is restricted [14]. A key challenge to the application of speech-based control for agile aircraft is efficient dialogue design [81]. The vocabulary and syntax must be manageable, without imposing a great memory load on the operator or interfering with the pilot's communications. Voice commands should also be simple and consistent across different functions. If the pilot has to look down into the cockpit to read command names off a menu, then the head up control advantage of speech-based control is compromised. Use of speech input also has the potential of rapidly accessing functions several levels down the hierarchical structure of a multifunction control. For example, a speech command may enable more rapid switching of the various systems involved in changing from a defensive to offensive posture. On the other hand, selection of a dedicated, frequently selected switch (e.g., HOTAS concept) may be more rapid than issuing a voice command. Such an automated manual response can be faster than the mental processing involved in issuing a verbal command and the time required by the voice recognizer to process the signal. The latter was the basis of comments by pilots interviewed by the Working Group who stated that they preferred using speech-based control only for secondary housekeeping tasks. Another option is to integrate speech recognition in cockpits as a redundant control, such that pilots can choose the most compatible input method, given the current task load and presence of ongoing radio communications.

6.4.3.6. GESTURE-BASED CONTROL

Besides using the electrical activity produced by slight facial gestures (see EMG-based control in 6.4.3.3), other small sensors mounted in the oxygen mask can be used to track fine movements of the pilot's face or lips. Optical and ultrasonic sensing technologies, for instance, have been used to monitor an operator's mouth movement. In one implementation, a headset boom located in front of the speaker's lips contains an ultrasonic signal transmitter and receiver. A piezoelectric material and a 40 KHz oscillator are used to create a continuous wave ultrasonic signal [82]. The transmitted signal is reflected off the speaker's mouth, creating a standing wave that changes with movements in the speaker's lips. The magnitude of the received signal is processed to produce a low frequency output signal that can be analyzed to produce lip motion templates.

There are two candidate applications of lip motion measurement. In one, the pilot's lip movements are processed during speech inputs to provide "lip reading." An experiment using an ultrasonic lip motion detector in a speaker dependent, isolated word recognition task demonstrated that the combination of ultrasonic and acoustic recognizers enhances speech recognition in noisy environments [82]. Alternatively, symbolic lip gestures can be translated into communication tokens that are used as control inputs. Lip gestures do not have high resolution and cannot be used for tasks requiring precise control. They need to be concise and quickly delivered, in order to minimize fatigue and interference with speech communication.

There are other facial signals that can be detected, although much of this technology is still immature. An infrared source and associated detector that illuminates the underside of the chin can be used to detect tongue position. By employing special mouthpieces, tongue-operated pointing [83] and tongue-operated keypads have been demonstrated [84]. It is also possible that unique acoustic signatures can be created by different teeth clicks that, in turn, can be harnessed for control.

6.4.3.7. DISPLAYS IN THE PERIPHERAL VISUAL FIELD

Given the increased likelihood of spatial disorientation in agile aircraft, the "light-bar" attitude display or "Malcolm Horizon" was reviewed [85]. This concept involves projecting an artificial bar of light across the instrument panel and having it move in a manner corresponding to the horizon outside the aircraft. Such a display enables attitude information to be acquired in the pilot's periphery in addition to what attitude information is provided in the primary flight display. Although pilot response to early demonstrations of this concept was positive in general, problems with upright-inverted ambiguity were noted. Also, pilots requested a means of slewing the beam vertically to position it on the desired location on the instrument panel or canopy bow.

The display of information in the pilot's periphery also takes advantage of the human's increased ability to detect movement in the periphery, compared to central vision. Thus changes in attitude may be more readily detected with a peripheral display. On the other hand, this phenomenon may make the frequent detections of attitude changes a source of distraction. Or the peripheral display may not be perceived at all, if the pilot is attending to the central field. To date, efforts to develop large-scale peripheral attitude displays have met with only mixed success [52] and their value for agile aircraft can only be determined with additional evaluation. These evaluations should examine both the utility of a peripheral "bar" display, but also a more textured format that provides a "flow field" (e.g., emanating from the vertical velocity point) in the periphery. The likelihood of operational HMD/T systems also needs to be considered when implementing peripheral visual displays. Other modalities (tactile and auditory, see 6.4.3.8 and 6.4.3.9) may also be useful for increasing attitude awareness.

6.4.3.8. TACTILE DISPLAYS

Since the surface of the skin is accessible, extensive in area, richly innervated, and capable of precise discrimination, tactile displays are another candidate device for agile aircraft applications. ("Tactile displays", herein, refer to devices that convey distributed sensations, rather than devices that provide vector force haptic feedback.) Tactile displays located on the human trunk have the potential of providing information without interfering with motor or any other sensory function. Also, the perception does not require the pilot to glance into the cockpit; hence, tactile displays are classified herein as a head up device. The human skin responds to several distributed physical quantities: vibrations, small-scale shape or pressure distributions, and thermal properties [86]. Vibration-based displays use frequencies ranging from a few Hertz (Hz) to a few hundred Hz. For aircraft applications, the distribution of skin stimulation is mapped to the state of some aircraft parameter or system. For instance, one university group [87] is examining microelectronic mechanical systems which, when integrated with a fabric suit, can provide a thumping or gentle pressure on a certain part of the pilot's abdomen. The envisioned application is to notify the pilot when the aircraft is listing to one side or the other.

One tactile display has already been demonstrated for a helicopter application. The Tactile Situation Awareness System (TASS) is designed to provide an indication of velocity direction and velocity vector magnitude [88, 89]. Specifically, 22 pneumatically driven tactors (1.25 in diameter) were integrated into an YF-22 cooling vest worn on a pilot's torso (Figure 7). By activating (vibrating the membrane at +/-2 PSI amplitude at 50 Hz) different tactor locations on the torso, the direction of helicopter drift (in 45 degree increments) was indicated and the tactor activation pulse pattern (rate of turning tactor on and off) was used to indicate the magnitude of drift (tactor activated at 1 pulse per second = .3-.7 m/sec; 4 pulses per second = .7-2.0 m/sec; 10 Hz = 2.0 m/sec or greater). The preliminary results from four pilots completing hover manoeuvres suggest that such a tactile display may improve pilot awareness of helicopter movement and reduce workload, especially under reduced visibility conditions. As one pilot commented: "I could feel the tactors before I could detect visual cues of movement." These results should be viewed as a preliminary indication that the tactile situational awareness system may have the potential to reduce the agile aircraft pilot's workload and enhance situational awareness. This promising technology may also have additional applications for altitude awareness (e.g., using a tactile display on the left arm), position maintenance around a reference point, directional indication of threats, and non-verbal communication. The utility of tactile displays is determined in part by their limited resolution (discrete

number of factors), the limitations in the rate at which pilots' can effectively use incoming tactile data, and their utility under acceleration. In particular, evaluation is required to determine how pilots resolve any conflicts between visual and tactile information.

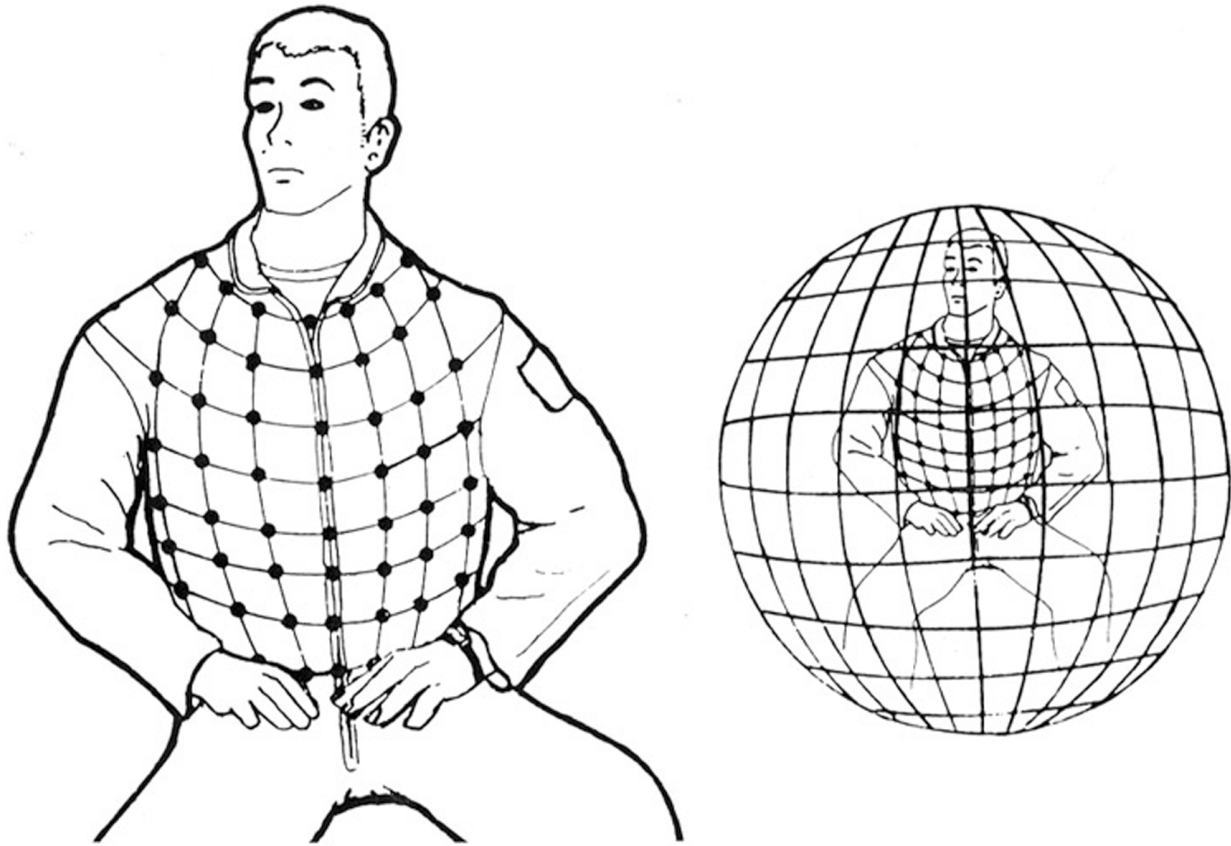

Figure 7. Schematic of Tactile Display Concept [89].

6.4.3.9. AUDITORY DISPLAYS

Like tactile displays, auditory displays are a “head up” source of information for pilots. Although auditory signals have been used in crew station design for some time, to date they have been limited to single frequencies or voice communications, primarily presented monaurally. In one application, navigation deviations were indicated with a Morse code type auditory signal: a Morse code “A” for one direction and an “N” for the other. The two frequencies fused into a steady tone of 1,020 Hz when the aircraft was on course. Changes in both frequency and pulse rate of an auditory signal have been used to indicate key points or detents in AOA (30, 40, and 70 degrees). Another approach “aurally” presents several flight parameters with an acoustic orientation instrument. The instrument displays airspeed as a sound frequency (repetition rate), vertical velocity by amplitude modulation rate (increase shown by increased pitch), and bank angle by right/left lateralization (louder signal in side that is same as direction of bank). This display was presented to pilots over earphones, after processing the auditory signal to map with the actual aircraft flight data. The results showed that acoustic signals can be useful indicators of the orientation of an aircraft, and interaural intensity differences, representing bank angle, are particularly effective in this regard [90].

Additional improvement in the acoustic orientation instrument might be realized by using three-dimensional localized signals, rather than lateralized signals. This is now possible due to recent advancements that have enabled the faithful reproduction of omnidirectional, complex auditory signals. This includes duplicating the interaural intensity difference (mainly high frequency components), interaural time difference (primarily used for low frequencies) and the direction dependent spectral information that occurs when incoming sound impinges the head and outer ear (pinnae). The latter are especially important to externalize the sound to appear “outside of the head.” The major determinants of the apparent direction of a sound involve digital filtering that is based on the free field to eardrum head related transfer function. To reproduce the dynamic cue changes that occur with the pilot’s head movement, some type of head tracker needs to be integrated with the audio display. Head tracking enables the headphone presented stimuli to be corrected in real-time so that they are perceived by the pilot to be at fixed positions in physical space [91].

For agile aircraft operation, the combination of three-dimensional auditory displays with a HMD/T may be especially useful (see Figure 8). When an auditory event is outside the visual FOV, the natural reaction is for the human motor system to perform whatever motor actuations are necessary to focus the visual system on the location of interest. Thus, for agile aircraft operation, the auditory cues could improve SA by informing the pilot that critical visual information lies outside of the current visual field. The spatial auditory cues may even indicate exactly where the information is located relative to the current position of the pilot's head. In a study which compared different methods of directing attention to peripheral targets, target acquisition time with three-dimensional tones was less than other auditory signals (coded aural tone, speech cue, and three-dimensional speech cue) [92]. In another study, use of spatial information from the auditory channel reduced search latencies on the order of 100-200 milliseconds. This advantage increased as the eccentricity of the target increased beyond the limits of the central visual field [93]. The results of an evaluation on the effects of using localized auditory information to perform a target detection task using a HMD in a simulation study were similar. Subjects were able to detect targets with less overall head motion and reduced head velocity [94]. Under high acceleration environments, this may help reduce the risk of neck and shoulder fatigue and injury. In actual Harrier flight tests, a three-dimensional audio system was particularly effective for azimuth cueing. Aviators were able to discern targets separated by 12-20 degrees [95]. Three-dimensional elevation cues, however, did not provide similar precision, but were adequate in discriminating two spatial levels (low versus high).

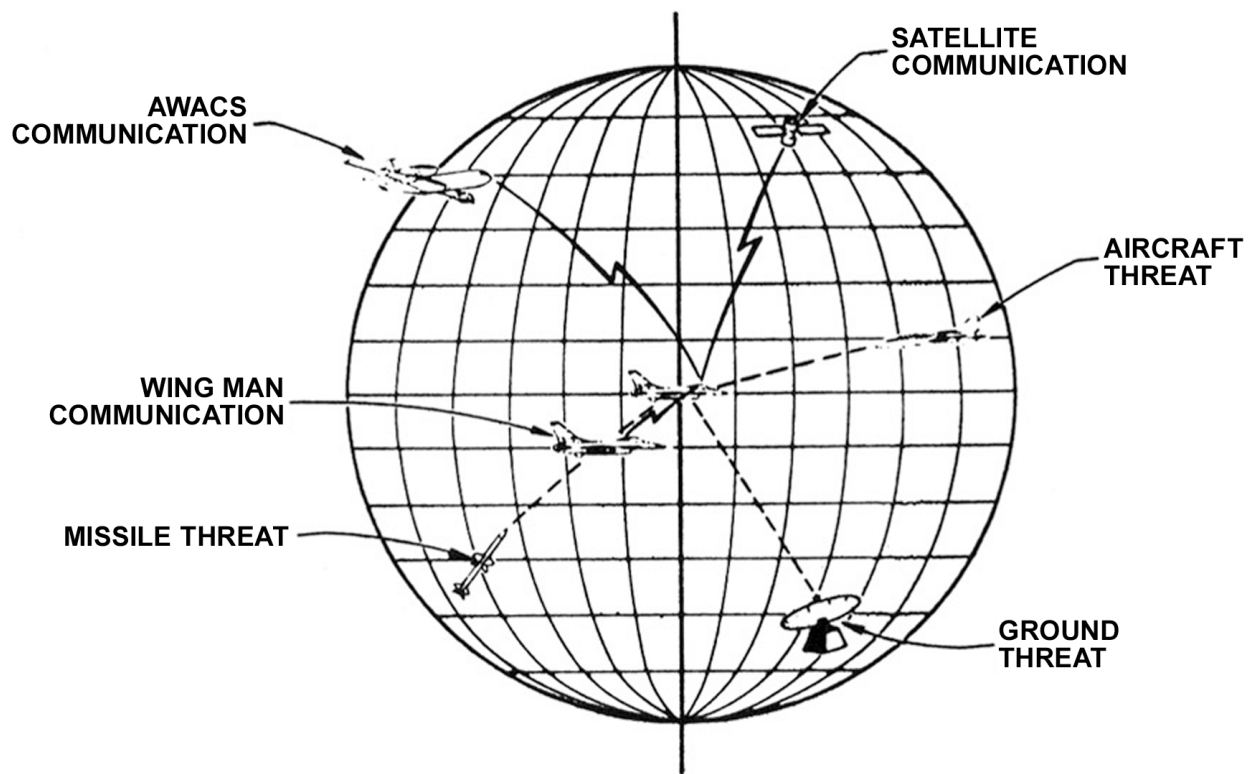

Figure 8. Schematic Illustrating Application of Three-dimensional Auditory Display for Three-dimensional Awareness of Threats and Communications.

Speech intelligibility and discrimination can also be improved by localizing speech inputs. Small angular separation of messages (45 degrees) has been found to greatly improve speech intelligibility. At 90 degrees of separation, the speech intelligibility levels were maximized and further separation did not yield higher intelligibility levels [96]. A three-dimensional communication-separation system also worked well in Harrier flight tests, aiding the copy of dual message traffic [95].

Information from spatialized auditory cues can also help code system status information. For example, to aid the pilot in understanding a critical situation and add redundancy to the message system, a left engine auditory fire alert message could be displayed such that it appears to emanate from the left. By accessing two modalities simultaneously with similar information, the pilot is less likely to miss the critical event. In another candidate application of binaural sound, the auditory space is used to indicate the level of urgency of an auditory warning. The most urgent warnings would be presented so they are perceived inside the head, while less urgent warning are perceived to the sides [97].

In sum, three-dimensional auditory signals have the potential of being detected more quickly than visual signals, and, at the very least, relieving the pilot's already overburdened visual workload. Some candidate agile aircraft applications of three-dimensional auditory displays include: 1) alert pilots of ground or aerial threat location and facilitate target acquisition, 2) enhance SA during A/A combat by localizing voice communications (e.g., wingman location), 3) segregate multiple channels of communication so as to improve intelligibility, discrimination, and selective attention among audio sources, and 4) provide an additional cue for location and/or urgency of an aircraft system malfunction. Before these candidate applications can be implemented in agile aircraft, further research is required to determine how best to exploit the capability to present spatial auditory signals and the best format for the information to be presented. For instance, the speech cue "bandit at 090" presented monaurally might be difficult for the pilot to rapidly interpret. It is not clear, though, what the optimal format is: this same speech cue, but have it appear to emanate from a spatial location, or a three-dimensional tone.

Given the demanding flight manoeuvres anticipated for agile aircraft, auditory localization accuracy under varying levels of sustained +Gz acceleration is of interest. The results from one centrifuge evaluation [98] showed that localization error did not significantly increase between 1 and 5.6 +Gz. Error did significantly increase at the 7.0 +Gz level, although this performance decline can also be related to the difficulty making the manual response required in the experimental task. Localization performance in agile aircraft will more likely be influenced by factors already known to have an effect in ground-based simulations. First, auditory cues will need to be presented over headphones, as opposed to free-field localization, the latter providing more accurate localization. This is not foreseen as an insurmountable problem, since localization errors using headphone presentation has been reported as low as 4.4 to 5.9 degrees, depending on the type of stimulus [99]. Also, given the large FOV, a general indication of a target's position (e.g., within 25 degrees) will greatly benefit the pilot. Second, errors in elevation are larger than for azimuth [100]. This is because cues to azimuthal locations involve interaural level and time differences, while elevation is cued by spectral differences. Once again, the pilot will benefit from any veridical directional information, whether it be solely azimuth or also include a coarse indication of elevation (e.g., high versus low). Third, and most important, it is likely that auditory localization will be accomplished with minimal movement of the head, since the pilot will most likely be attending to the forward FOV [101]. This impacts performance because movement of the head helps disambiguate front/back reversals by tracking changes in the magnitude of the interaural cues over time influenced by the apparent source position. The most common type of reversals in auditory localization is when sounds simulated in the front hemisphere are heard at the mirror image position in the rear. The percentage of front/back reversals can be as high as 50% of the classifications [101]. Until this confusion is controlled, application of three-dimensional auditory displays might best be limited to serving as a redundant cue. Also, further research is required to evaluate dynamic auditory resolution for stimuli varying in location, velocity, motion direction, and frequency.

6.5. HEAD DOWN CONTROLS AND DISPLAYS

As shown in the preceding sections detailing head up controls and displays, a great deal of information can be provided to pilots of agile aircraft with head up or helmet mounted displays and other display and control devices which can be employed without requiring pilots to look down into the cockpit. However, the control panels inside the cockpit offer valuable area for providing pilots supplemental information and control options. The following will address head down controls and displays in more detailed.

6.5.1. AGILE AIRCRAFT IMPLICATIONS ON HEAD DOWN CONTROLS AND DISPLAYS

For within-visual range scenarios, it is advantageous for the agile aircraft pilot to keep the head up and out of the cockpit as much as possible. Therefore, in order for pilots to realize the advantages of head down controls and displays, the information needs to be easily acquired and the control operations quick to complete. In other words, the head down devices need to provide more capability without impacting the advantages afforded by keeping the pilot's head up. This presents a difficult challenge to designers – *maximizing* the information conveyed or inputted by head down devices while *minimizing* the time required for head down viewing. Moreover, the cockpit design needs to achieve this without increasing the pilot's memory and processing requirements and overall workload. The following address this and other implications.

6.5.1.1. NEED FOR TAILORING

With increasing onboard processing capabilities, agile aircraft will have a concomitant increase in the number of systems and possible data views. These additional capabilities translate into an increase in the number of control and display options for each system. The pilot's time can be consumed just programming the numerous options available. Multiple options also incur excessive training costs. For agile aircraft operation, cockpit design and standard operating procedures should focus solely on those options essential to mission requirements. For these critical options, the requisite control and display functions need to be clustered together, rather than requiring the pilot to navigate through a complex menu structure to call up an option. The pilot should also not be required to set a series of switches in a particular position and sequence to perform a desired function. One mechanism is to have one command or input automatically activate the systems and set up the tasks relevant to the current flight segment (e.g., A/A versus landing).

Only those options required for that flight segment would be readily accessible [14]. This change of formats, etc. with mission or flight mode is facilitated by the availability of software driven programmable (multifunction) displays.

6.5.1.2. HEAD DOWN TUNNELING OF PILOT'S ATTENTION

Even with careful design of head down controls and displays, it is possible for a situation to occur (e.g., changing threat scenario) that attracts the pilot's attention and delays the pilot from returning to a head up posture. Some cueing mechanism is required to inform pilots of critical information or a change in aircraft or mission state that needs attention.

6.5.1.3. HEAD DOWN DISPLAY REQUIREMENTS

Information critical to the pilot maintaining control of the aircraft and managing the weapons systems when engaging the enemy will be presented on a helmet mounted display. In the event the head up devices become damaged or inoperable, the formats should be presented on a head down display instead. There may also be a need to have some flight control information redundantly displayed head down as well. However, the primary function of head down displays is to increase the SA of pilots and provide additional systems information. If this information continues to be presented on numerous dials, indicators, multiple small displays, and with different range scales, it will be very difficult for pilots of agile aircraft to rapidly fuse the information together to access the situation.

One solution is to present this information on a single large flat panel or high resolution TV display. With this approach, all the individual devices are replaced with one presentation [28]. Merely moving all the information onto one surface would not facilitate pilot performance. Rather careful format design is required to identify an integrated format that will assist the pilot in identifying and prioritizing actions to be performed in microtime. The display should be it easy for the pilot to determine what actions are possible at any moment and evaluate the current state of aircraft systems [102]. In other words, the "right information" in a useful format needs to be presented at the "right time." Indicators should employ labels that immediately convey their meaning to the pilot. Moreover the information needs to be presented in the "right location" – any critical information should appear at the same location all the time.

With software driven programmable displays, there is virtually no limit as to how information can be presented. This is a mixed blessing because there is a natural tendency to provide the pilot with several options, not knowing the optimal approach in advance. This is counter-productive, adding to the pilot's visual workload and cognitive demands to filter out the required information. Indeed, the optimal format is likely to be a function of the current flight segment/task or the pilot's preference. Display formats for head down displays (as well as head up displays) represents a research topic requiring significant attention. Specific design guidelines and useful metrics for managing the presentation of information in multipage displays are available in [103]. One key finding is that the structure of a multifunction device must be responsive to the operator's cognitive model of information relatedness, rather than that of the system designer.

To illustrate the complexities in designing display formats, consider the challenge of presenting pilots with the information required to attain multiple views of the world. In one view, the "ego" view, the world is represented as how it would be seen through the pilot's eyes. In this "inside looking out" perspective, pilots perceive themselves to be located inside the displayed world looking out at it. To achieve a total "immersion" sensation, a large FOV is required. For pilots to understand where they are located in the world and what geographical locations are in relationship to current aircraft position, another "outside looking in" view is required. Instead, outside-in portrayal is typically achieved on head down displays and includes a map or horizontal situation view. With this information, pilots can easily make changes in navigation routes, etc. Information from one or more sensors such as radar or forward-looking infrared (FLIR) presented on a display with a "sensor view" may also be beneficial [14]. This specific example illustrates the need to not only evaluate the formats that depict particular viewpoints, but also how the pilot should switch from one view to another and how the SA garnered from each one is kept consistent with the others.

6.5.1.4. HEAD DOWN CONTROL REQUIREMENTS

Similar to head down display requirements, head down controls need to be organized by function and support decision making or execution in a timely manner. With a function-based organization, all the information and control devices needed for a particular set of activities should be in close proximity and available with less than two key presses. This is a much more difficult design challenge than organizing controls by aircraft systems and subsystems. Extensive human factors engineering, task analysis, design iteration, and evaluation are required to identify the systems and functions required for each flight segment. Proper and consistent formats, abbreviations, symbol meanings, control assignments, procedures and rapid (less than 0.2 seconds) feedback need to be employed so the action required and status of each control operation is intuitive to the pilot [35].

Many secondary systems are controlled by the pilot selecting pages on a cockpit display using buttons on the periphery of the display or a touch sensitive screen. While a large number of systems can be controlled via one control device (single display and surrounding buttons), there is a danger in the pilot spending excessive time with the head down in order to progress through multiple interface layers or windows. This can lead to disorientation and a distraction from

the primary tasks of maintaining SA and flight control. Head down controls need to be easily located, grasped, and manipulated. Moreover, the design needs to allow flexibility in control usage such that the pilot can tailor the display content, change the sequence of control operations, take shortcuts (e.g., circumvent menu with verbal command), and easily reverse actions and correct errors.

6.5.2. CANDIDATE HEAD DOWN CONTROLS AND DISPLAYS

6.5.2.1. HEAD DOWN SYSTEMS CONTROLS

As mentioned above, many control functions are activated by selecting a switch associated with a function presented on a display. With a multifunction control, the functions associated with each switch change depending on the flight segment or task to be performed. Human-engineered design of the required interactive sequences is key to the utility of a multifunction control [104]. In some implementations, functions can be selected “more directly” by pressing the display surface over the appropriate label. Function selection using touch-activated displays has proven to be fast and accurate, as well as easy to learn in ground-based applications [105]. However, operators must be more attentive to visual and audio feedback due to the lack of the kinesthetic feel associated with manipulating real switches and knobs [106]. This is even more problematic for pilots under heavy workload. Selection of small targets or closely spaced functions is also difficult, especially with flight gloves (one pilot described as “Fist on Glass”). An even more limiting factor is that manual selection is less desirable during the rapid flight path changes anticipated in agile aircraft flight.

The application issues discussed earlier (6.4.2) for head up control are also pertinent to head down control operations. Hands free controls described in 6.4.3, along with the HOTAS concept, would enable pilots to select these head down functions while retaining their hands on the stick and throttle. Eye and speech-based control are the nearer-term hands free controllers. Certainly both are likely to provide faster activation than manual selection of front panel switches and functions. For example, the eye fixates a desired function before the hand is moved to the fixated position, making eye-based control an attractive option [107]. There are also methods by which eye-based control may be useful for a variety of graphic-user-interface dialogues: menu pull down/selection, text scrolling, and moving an object [72]. These interactions, however, are more time-consuming and may be more appropriate for applications other than agile aircraft. However, for function selection, especially in a multi-modal control context (see 6.6), eye-based control may be very useful to the agile aircraft pilot.

In addition to the systems controlled by pushbuttons, multifunction controllers, dedicated switches (e.g., weapon jettison), etc., the primary controllers located in the cockpit are the stick and throttle. With the HOTAS control concept, many functions are controlled with switches resident on these primary controllers.

6.5.2.2. HEAD DOWN DISPLAYS

The flight control stick can also serve as an avenue to convey information to the pilot. In the past, stall warning systems employed stick shakers or stick pushers to warn pilots of impending stall conditions. The pilot’s attention can be easily acquired by altering the control stick’s force gradient [108]. More recently, the utility of the pilot’s sense of touch was examined in a landing experiment that fed information concerning lateral deviations from a runway centerline into a force reflecting control stick. The results indicated a consistent advantage in performance and perceived workload for the force feedback system, particularly for landings conducted under heavy turbulence [109].

The majority of head down information, however, will be presented on software-driven displays. The actual hardware used will depend upon ongoing advancements in cathode tubes and flat panel display technologies; operational displays need to be flightworthy, sunlight readable and compatible with night vision devices [14]. At the very least, several smaller display surfaces will be used. However, advanced designs are now focusing on the use of a panoramic display (e.g., via projection or arrays or seamless tiling of flat panel displays) which would present one integrated format or several groupings of formats on one display surface [28]. The choice of the information to be presented and the format of this information will determine the extent to which the head down display(s) is an asset to the agile aircraft pilot.

The head down imagery is the pilot’s key source of SA information. In contrast to the head up information pertaining to flight control and near term weapon and threat information, the head down display(s) provides the pilot with the big picture – including the nonvisual spherical world around the pilot ranging from 0-200 miles. To provide this SA, a plan view is beneficial, with ownship position decentered, because of the higher interest and lethality in the forward hemisphere [110]. Ideally, information from the various sensors can be fused together on a single display. If the sensor information cannot be fused, then the data should be integrated and coded such that the pilot knows the source of each datum rather than present sensor data on numerous different displays, each with different range scales and ownship locations [110].

For map displays, the scale and frame of reference (track up or north up) should be pilot selectable. As a default, a track up view in which the map display rotates to match the momentary heading of the aircraft is better in that it eliminates the need for the pilot to do mental rotation [60]. A three-dimensional presentation may help provide information about

the relative distances of objects from the ownship. To date, though, there has not been a consistent advantage of a two-dimensional approach versus a three-dimensional approach (see also 6.4.3.1.5) [60]. Use of color coding for map displays has been found to be useful for distinguishing boundaries and differentiating symbology sets. For airborne environments, however, the technical limits on brightness, chromaticity, and contrast in high ambient illumination need to be considered.

Besides information pertaining to the outside world, the head down display(s) is the primarily source of information for weapon management and monitoring aircraft systems status. Considering the number of onboard systems, presentation of comprehensive information on each system would place an unnecessary burden on the pilot. Rather, the information needs to be limited to that which is meaningful or more easily used by the pilot. Examples include fuel in available range format and threats as potential killers or not [1]. For some systems, a pictorial presentation of the information may be more intuitive to the pilot and more quickly assimilated. Figure 9 shows some examples that were generated in a study to examine use of pictorial formats for military cockpits [58]. Pictorial symbols can be used to describe the

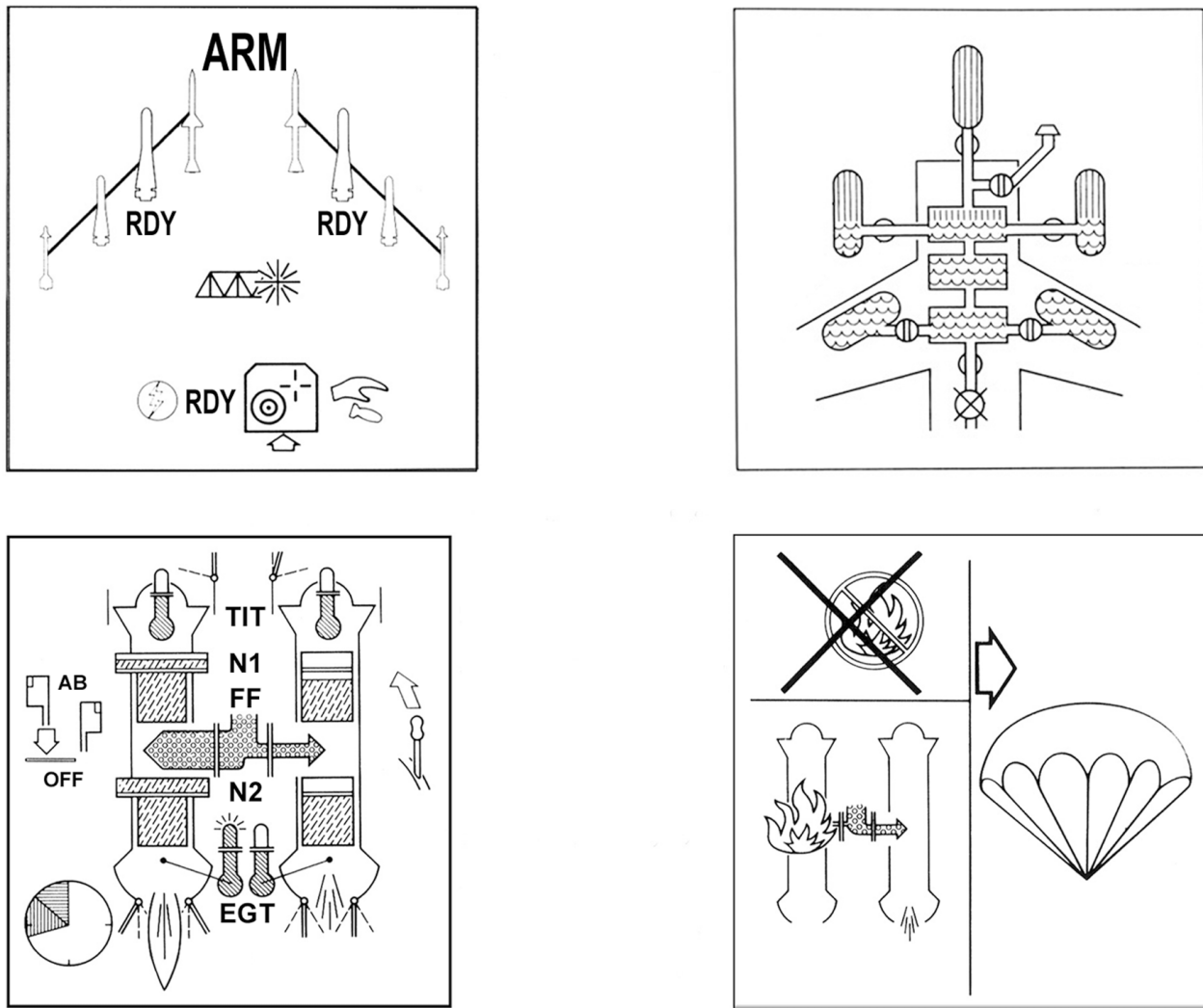

Figure 9. Example Pictorial Display Formats Showing Systems Status [58]. Weapons format (upper left): selected weapons are displayed both oversized and with the annotation “RDY” (redundant coding). The weapon delivery program selected (a bridge attack) is also indicated pictorially rather than numerically. Fuel format (upper right) shows distribution of fuel across main, wing, and external tanks as well as status of fuel flow valves and boost pumps. Engine format (bottom left) shows turbine inlet temperature, fan and compressor speeds, and exhaust gas temperature parameters. Fuel flow and flow rates are shown by the relative size of the arrow pointed towards the engine and the movement of bubbles. A disparity in fuel flow is shown. The extra plume on the left engine indicates that it is in afterburner. Engine format (bottom right) shows presence of fire and that the fire extinguisher has failed. The recommended action for the pilot is pictorially indicated – eject!

status of subsystems as well. For example, a pictorial representation of the four mechanical fuzing options (nose, tail, both or none) provides a more realistic impression of what is actually happening with the fuzing, compared to an alphanumeric readout. Color coding can also be very useful to note operating ranges of a system parameter, with different colors denoting normal, slightly out of tolerance and dangerous conditions. For specific applications, evaluations are required to determine whether additional costs to provide pictorial and color formats are merited in terms of aircrews' performance and preference. In one simulation study, there were no significant differences in aircrews' opinion and performance with color pictorial formats compared to monochrome pictorial formats [111]. This study also documented extensive comments on specific pictorial symbology used on head up display and status formats (perspective situation, horizontal situation, engine, fuel, electrical, hydraulic, passive sensor system, and advisories). In another study [112], the potential value of a three-dimensional portrayal of pictorial formats was evaluated for crew station applications. The results showed that adding stereo enhances performance by augmenting monocular depth cues, but that it is not an effective replacement for differential color as an attention-getting dimension. This study also provides extensive pilot comments on three-dimensional pictorial formats for specific flight segments and illustrates the role of display resolution and the amount of disparity on performance.

6.6. MULTI-MODAL CONTROLS AND DISPLAYS

As illustrated by the earlier description of visual, auditory, and tactile controls and displays, the crew station designer has a variety of modalities to select from for use in cockpit interfaces. The designer also has an opportunity to use a *combination* of modalities for the information exchange between the agile aircraft cockpit and pilot. For instance, multi-modal control can benefit pilots by providing multiple means of inputting information into aircraft systems. Also, a combination of two or more input devices can perform some control functions better than either one operating alone. One disadvantage is the additional load on the pilot to remember the steps used to employ the different control modalities.

Similarly, a multi-modal display in which the pilot receives information through more than one modality would be very beneficial in those instances when one information processing channel is overloaded. Moreover, the multi-modal display may also be more salient or attention getting than a single-modal display. Conversely, multi-modal displays have the potential of burdening the pilot with superfluous stimulation. It is only through research that the optimal multi-modal control and display configurations can be identified for specific tasks/applications.

6.6.1. CANDIDATE MULTI-MODAL CONTROLS

Just as operators with desktop computers can navigate with a variety of controls (mouse movement, arrow keys, tab key), it is possible to implement aircraft systems such that several control modalities can be used for a single control action. This mapping approach provides the pilot with increased flexibility: a) the pilot may have individual preferences for specific controls, b) a temporary task or environmental condition may deem one control device more efficient than another (e.g., eye-based control when manual selection is difficult under high acceleration or positive pressure breathing interferes with speech-based commands), and c) should one control device malfunction, the pilot can use a different control.

A multi-modal approach is also useful when two or more controls are integrated such that they are used together to perform a task. In one integration approach, a control technology that cannot perform a particular function alone can be used to improve the performance of another control. For instance, eye line-of-sight data might be used to enhance speech processing by restricting the vocabulary search to the most probable verbal commands associated with the current gaze point. In another type of integration, two or more control devices operate in parallel to increase the accuracy or reliability of a control action (lip movement data when used together with acoustic signals can improve speech recognition compared to either one alone). In a third integration, controls are mapped to different subcomponents of a task. For example, the pilot can use eye gaze to designate a waypoint on a map display and a voice command can serve as a consent response, commanding the navigation system to update the mission plan for the last waypoint designated by the eye gaze. It would be difficult to use the individual control devices for the two steps. The use of both control devices capitalizes on the ability of eye gaze to rapidly designate a position on a two-dimensional surface and voice commands to quickly initiate an action. In fact, eye and voice systems can replace or augment conventional controls for many interactions with aviation displays (e.g., configure displays, tailor displayed information, retrieve information, and input information) [113].

6.6.2. CANDIDATE MULTI-MODAL DISPLAYS

Multi-modal displays may be more effective in warning the pilot of an aircraft system malfunction or an impending threat. In one experiment, a multi-modal display was found to be beneficial in alerting subjects to a dangerous situation. Visual icons and verbal warning messages were used singly and in combination and the results showed a significant decrease in response latencies when correlated bimodal information was provided, as compared to either unimodal alert [114]. In another experiment in which the subject had to acquire target aircraft which appeared in unknown positions,

both a three-dimensional tactical (visual) radar display and a three-dimensional auditory display were presented to provide the pilot with information about the target aircraft. The radar display showed the target's relative speed and whether it was above or below ownship. The auditory display showed the direction of the target to ownship. The displays also differed with respect to frame of reference. The radar display was outside-in, indicating the relative position of the target as seen from above and the auditory display was inside-out, indicating position relative to the subject's head. The results showed that both displays, when used individually, reduced search time [115]. However, when the two modalities, visual and auditory, were used simultaneously, search time was reduced even more. In this example, the displays provided complementary information that resulted in a benefit to performance.

Multi-modal displays can also help overcome the inherent limitations of display technologies when used individually. For instance, target detection performance has been found to be poorer with a HMD compared to a full FOV visual condition [116]. The results of follow-on research suggest that a three-dimensional auditory display can be effective in mitigating the negative effects associated with performing a visual target detection task with a HMD [92]. Another example where two modalities could complement each other is three-dimensional auditory displays and tactile displays. Together, they might provide a more accurate nonvisual indication of threat locations to pilots.

6.7. INTELLIGENT INTERFACES

6.7.1. ADAPTIVE INTERFACES

The use of computer-driven controls and displays in agile aircraft cockpits offers the opportunity to include intelligent interfaces that help the pilot acquire information and execute decisions. This would provide more time for the pilot to control the aircraft and think about decisions that must be made. To meet this objective, the displays must be configured to provide information salient to the specific situation being addressed by the pilot and the controls must facilitate the pilot's response. The use of tailoring has already been introduced (6.5.1.1) — only information previously determined appropriate for the current flight phase is presented. This tailoring is a result of an explicit control input by the pilot (e.g., selection of a flight mode switch). However, it is likely that the pilot would benefit from variations in the control/display configuration for specific tasks within a single flight segment. Rather than have the pilot continually commanding the system to make such changes (and in cases where the pilot is over loaded or incapacitated), it is desirable to have dynamically adaptive interfaces that change the display or control characteristics (perhaps both) in real time [108, 117] (see Figure 10). These changes are initiated by predetermined triggers:

- external (changes in mission, tactical constraints, number and location of threats, and aircraft system (hydraulic failure)),
- internal (physiological) indices (measurable aspects of the neurophysiology that index changes in the pilot's physical and cognitive states), and
- behavioral indices (overt behaviors executed by the pilot (eye gaze point, control activity, etc.).

Besides choosing and validating the triggers and decision rules that initiate the adaptations, the specific modifications to be made to displays and controls in each instance must be identified. Implementation of adaptive interfaces is also a challenge due to the real-time timing constraints and the need to analyze continuous parallel input streams from numerous sources [72]. To ensure that the candidate adaptive interfaces are indeed a benefit to the pilot, realistic simulation evaluations are required. Ideally adaptive interfaces will provide information in a form that is more easily accessed by the pilot, optimize pilot workload, and improve SA and spatial orientation. The goal is to provide the agile aircraft pilot with the right information, at the right time, and in the right location for optimal pilot performance and mission success. On the other hand, there are potential problems with impeding the cognitive momentum of the pilot and causing confusion by changing information. The lack of consistency could also interfere with the pilot's skilled-based behavior. However, the results of one pilot study suggest that dynamic changes in displays or controls will not interfere with the development or execution of skilled behavior [118]. This experiment utilized three interface conditions: conventional, advanced (flight director display and force reflecting stick), and adaptive (which switched between the conventional and advanced, depending on pilot performance on a simulated precision low-level navigation task). The need for further evaluation was indicated, though, that utilizes a richer experimental environment, additional task requirements, and more complex mechanisms to trigger adaptive changes.

Adaptive interfaces can also capitalize on the human's capability for parallel processing across sensory modalities. If a workload assessor determines that the pilot's visual channel is saturated, then a high-urgency display element that would nominally be presented on a visual display (e.g., approach of a G-limit) could be presented via the auditory system or via force feedback in the control stick. If it is determined that the pilot is heavily engaged in some activity (evading an enemy) and does not have the resources to attend to another task (activate the ECM), intelligent systems could automatically perform the task and inform the pilot of its completion [108]. In this case, the intelligent system is

not only changing the interfaces but also accomplishing a task for the pilot. This role of automation in crew system design raises additional issues, which are discussed below.

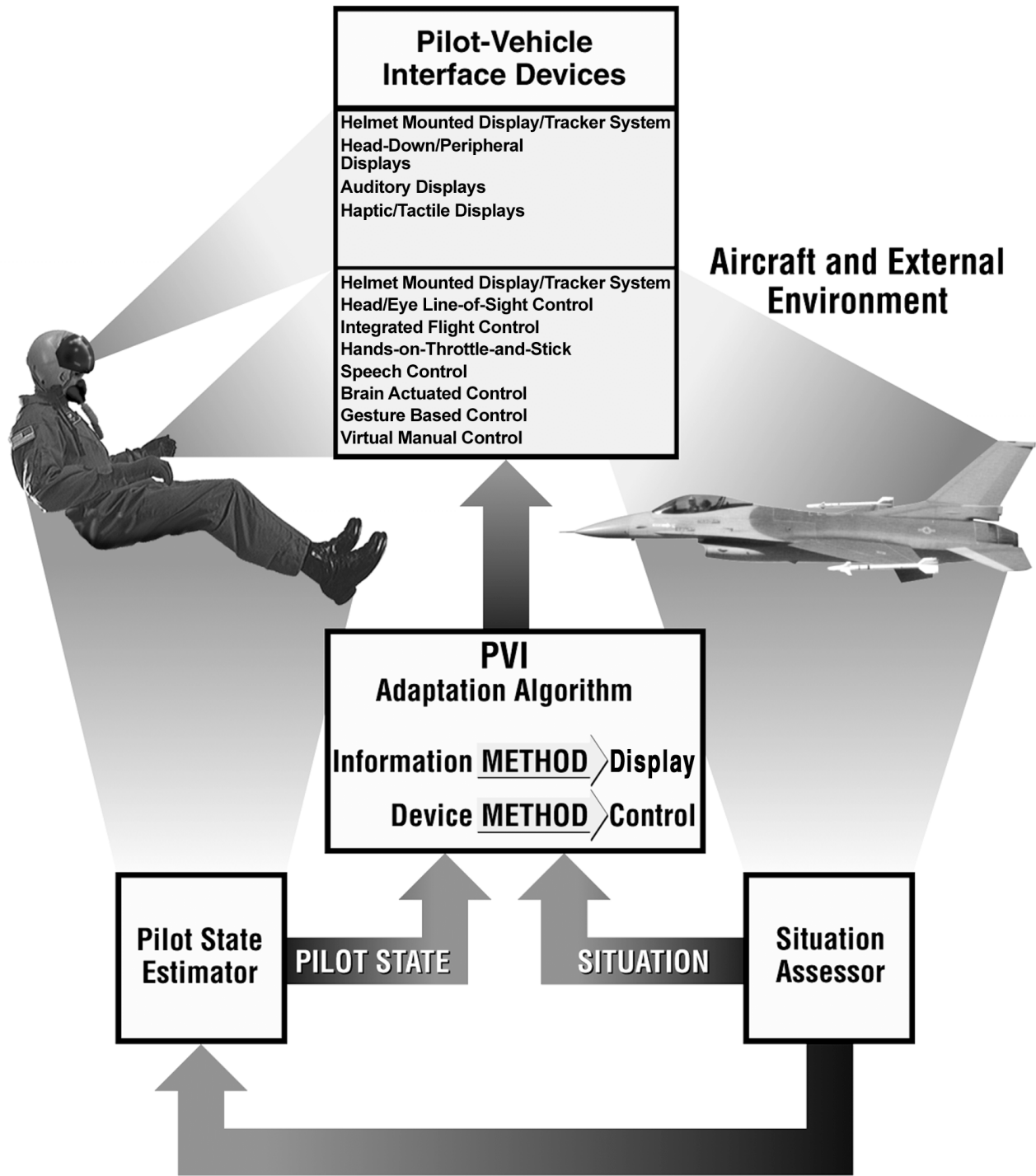

Figure 10. Illustration of the Role of Adaptive Interfaces in Crew Station Design.

6.7.2. AUTOMATION

Automation of some crew station tasks can certainly help reduce the heavy workload facing the agile aircraft pilot. However, problems with automation can arise due to “clumsy” use of this technology [119]. If the entire pilot/system operation is not considered, there is a likelihood of automation being activated at a time when it is least needed and hindering performance in situations where it is greatly needed. Even more common is the failure to provide the pilot with adequate feedback on the status and behavior of the automated system or task, which affects the pilot’s ability to maintain SA. The pilot needs to be able to maintain a mental model of both the monitored process and the status of the intelligent system, especially when multiple dynamic systems are in operation as is the case in aviation. Lastly, there are instances where automating a task is not in the best interests of the pilot. For example, having the pilot as a passive occupant during automatic guns aiming or automated missile avoidance can increase the pilot’s disorientation and sickness when the aircraft makes abrupt manoeuvre changes.

Some of these problems arise because the environment and workload characteristics of the cockpit are so complex and dynamic. What may be an optimal automation scheme for one flight segment/task may be totally inappropriate for another. Therefore, automation also needs to be dynamic or adaptive, with the goal of maintaining an optimal division of labor between the pilot and the aircraft [120]. In other words, the automation needs to be flexible and responsive to pilot and task demands and the same triggers used in adaptive interfaces are also useful for adaptive automation. With this pilot centered approach, there should be fewer difficulties with automation induced difficulties in monitoring and maintaining SA because the pilot is kept more involved. Tasks requiring judgement, multi-sensory information gathering, hypothetical reasoning, and contingency reaction are best suited with the pilot in the loop [121]. There are, however, some ongoing “housekeeping” tasks that can be automated; tasks that require accurate responses, fastidious and repetitive actions, and exhaustive calculations are good candidates for automation. The following are example candidate applications of automation:

- if an engine failure is detected, perform correction and concurrently notify the pilot
- manage fuel and hydraulic systems, but give high level information to pilot (range, malfunctions, etc.)
- perform appropriate actions for battle damages and inform pilot if operational capabilities or flight performance affected
- manage navigation systems, but store data for call up by the pilot
- assess situation, manage sensors, and attach confidence indicators to fused and correlated outputs
- analyze target to provide identification, performance capabilities and optimum engagement parameters
- deploy aircraft defensive measures when pilot is busy accomplishing a popup weapon delivery sequence [121, 122].

Besides adapting automation to the pilot and task demands, a human centered approach calls for obtaining the consent of the pilot (or requiring a command from the pilot) before initiating an automated action. This pilot preferred approach is referred to as “management by consent” — automation cannot take action unless and until explicit pilot consent has been received [123]. Since there are numerous instances where automation could play a role, requiring a consent response for *every* automated action is also unreasonable. It is recommended that the pilot input a nominal set of rules to be used by the automation system for the majority of tasks. For each task, the pilot should indicate preferences on whether the automation system should always perform the task, sometimes perform the task, perform the task and notify the pilot, or ask for permission to perform the task [122]. Having the pilot tailor the automation system before the mission helps minimize the chance of interfering with the pilot’s workload on other simultaneous tasks [1].

The term “management by exception” refers to instances where the system takes over *sometimes*. For instance, automation systems can be designed to perform less critical tasks on its own when it is detected that the pilot is suffering from demanding time pressures and workload. Of course, the pilot maintains an option to override this automation. There are also instance where pilot consent may not be practical (e.g., pilot injured) and function changes may need to be implemented directly by the adaptive system.

Given the number of aircraft systems and corresponding procedures and tasks involved, research is needed to decide how tasks should be shared between the pilot and aircraft, how much autonomy and authority should be given to each, and how agreements and commitments to actions can be negotiated between the two. Certainly, the degree to which automation is successful in agile aircraft is a function of the degree to which there is coordination between the pilot and the automation system. If this communication is adequately achieved, automation can assist the pilot by diagnosing deviations, identifying corrective actions to task, and executing actions to correct the state [121].

6.8. SUMMARY

The issues raised in this chapter pertaining to pilot protection/survival, controls/displays, and intelligent interfaces illustrate opportunities for enhancing the cooperative interaction between the pilot and the vehicle, with the ultimate

goal of achieving pilot-cockpit symbiosis. Moreover, the importance of the pilot-vehicle interface to the successful exploitation of agile airframes, agile weapons, and agile systems has been demonstrated. It is clear that considering ergonomics in crew station design is key to the success of agile aircraft.

6.8.1. THE GOOD NEWS

The results of the pilot interviews and the reviews of this Working Group show that *drastic changes in the crew station design hardware are not needed for agile aircraft*. For the most part, near term control and display suites (Figure 11), existing systems along with the advances that are nearing transition (e.g., HMD/T), are adequate for the pilot's tasks. Even though modifications in formatting and configuration are required to address specific agile aircraft issues (e.g., to present flight path information when at a high-angle-of attack), most are easy to implement since so much of the cockpit hardware is computer driven. A recent simulated air combat evaluation demonstrated: 1) the feasibility of implementing many of these advanced concepts, and 2) these advanced concepts can result in statistically significant advantages, despite the fact that the subjects (pilots from three NATO countries) were more experienced with conventional crew stations [124]. This evaluation assessed both a conventional cockpit (F-16/F-15 type cockpit displays) and a virtually-augmented cockpit (HMD/T system, pictorial formats, color coding, three-dimensional audio cueing for the radar warning receiver, and a ground collision avoidance system) using objective and subjective measures. The findings indicated that the new design not only resulted in superior mission performance, but also did so with less workload and enhanced SA. In general, those aspects of the mission that relied on target identification and maintenance of tactical position relative to the target appeared to be the most positively affected by the advanced crew station design.

Therefore, there is good news that significant investments in additional control and display hardware development are not required to meet the ergonomic requirements of agile aircraft. Far term developments that provide the pilot with *new* capabilities are, though, certainly welcomed candidates for agile aircraft application (see Figure 11).

NEAR TERM
Head Mounted Display/Tracker System Integrated Flight Control System Hands-on-Throttle-and-Stick System Speech-based Control for Secondary Tasks Improved Display Formats: color, pictorial, and sensor fusion
FAR TERM
Peripheral Visual Displays Three-dimensional Visual Displays Tactile Displays Three-dimensional Auditory Displays Eye-based Controls Gesture-based Controls Bio-potential-based Controls Multi-modal Displays/Controls Adaptive Displays/Controls

Figure 11. Candidate Near and Far Term Displays and Controls for Agile Aircraft

6.8.2. THE BAD NEWS

The results of this effort showed that the mental workload involved with information management in crew station operation is a limiting factor for agile aircraft operation. In order to achieve full operational performance in agile aircraft, the pilot must be able to perform several simultaneous functions: fly the aircraft, maintain SA of the total air battle scenario, communicate with friendly forces, plan attacks, fly complex attack manoeuvres, control aiming and release of multiple weapons, manage onboard systems, organize self defense against arriving threats, and perform high acceleration escape manoeuvre for threat avoidance [1]. Given the increasing number of systems involved in completing these tasks and the myriad of control options available, it is not difficult to understand how the pilot can be overwhelmed. Rather than helping the pilot with these added capabilities, the design may in fact be hindering the pilot's ability to execute and survive the mission.

The bad news is that the *current approaches for pilot-vehicle interfaces do not support fast assimilation of information and control actuation*. Simply, the right information is not being provided at the right time in the right location. It is this inadequate information flow between the pilot and the aircraft that is the limiting factor in the performance of agile

aircraft. Therefore, a significant investment is needed to conduct the human factors engineering, task analysis, design iteration, and evaluation needed to identify how controls, displays, and personnel protection systems should be implemented to support the pilot/airframe/weapons/systems information exchange [35]. Compared to past aviation ergonomic studies, this needed research will be much more difficult to conduct. As the complexity and dynamics of the systems increase, so do the ergonomic challenges to consider new styles of interaction. New requirements are levied on user interface software and user communication dialogues in order to handle and describe complex and substantial input/output processing, simultaneous/parallel operations, continuous inputs and outputs, and imprecise inputs and timing constraints. Thus, designers are faced with both a great challenge and opportunity to realize crew station designs that will truly enhance the operation of agile aircraft. Hopefully, the concepts and technologies introduced in this chapter will assist in this creation of a pilot-cockpit symbiosis for agile aircraft applications.

6.9. REFERENCES

1. Borowski, R.A., and Bava, R., Pilot/Vehicle Integration, in *Operation Agility*, AGARD-AR-314, April 1994; Chapter 4:164-178.
2. Licklider, J.C.R., Man Computer Symbiosis, *IEEE Transactions on Human Factors in Electronics*, vol. HFE-1, March 1960; 4-10.
3. Gierke, H.E., and van Patten R.E., Fighter Design for Human Load Limits, in *Workshop on Design Loads for Advanced Fighters*, AGARD-R-746, 1988.
4. Walsdorf, A., and Onken, R., The Crew Assistant Military Aircraft (CAMA) Workshop, in *The Human-Electronic Crew: The Right Stuff?* Information Brochure, September 1997.
5. Dudek, H.L., and Wittig T., The Electronic Crewmember for Future Commercial Air Transport Operations: Fantasy or Reality? *Workshop in The Human-Electronic Crew: The Right Stuff?* Information Brochure, September 1997.
6. van Blyenburgh, P., Europeans UAV's/Programmes, Development Projects and Awarded Contracts, *Military Technology*, August 1997.
7. van Blyenburgh, P., Europeans UAV's/Programmes, Development Projects and Awarded Contracts, *Military Technology*, September 1997.
8. Pilmanis, A.A. (Ed.), 1990 Hypobaric Decompression Sickness Workshop: Summary and Conclusion, in *The Proceedings of the 1990 Hypobaric Decompression Sickness Workshop*, USAF/AL Report AL-SR-1992-0005, 1992.
9. Pilmanis, A.A., *Raising the Operational Ceiling: A Workshop on the Life Support and Physiological Issue of Flight at 60,000 feet and Above*, AL/CF-SR-1995-0021, December 1995.
10. Wheeler, C., and Morris, J., Evolution of Ejection Seat Pintle Technology in *Proceedings of the 36th Annual Symposium SAFE Association*, 1998; 142-149.
11. Lingard, J.S., Naces P³I Phase II – An Overview, in *Proceedings of the 36th Annual Symposium SAFE Association*, 1998; 319-328.
12. Hall, J.B., The Vibrational Environment of an Ejection: Lessons Learned from the Fourth Generation Escape Systems Advanced Technology Demonstration Program, in *Proceedings of the 36th Annual Symposium SAFE Association*, 1998; 104-114.
13. Scott, W.B., 21st Century Fighters, *Aviation Week and Space Technology*, August 3, 1998; 38-74.
14. Hamilton, B.E., Expanding the Pilot's Envelope, in *Technologies for Highly Manoeuvrable Aircraft*, AGARD-CP-548, 1994; Chapter 22-1-22-6.
15. Ineson, J., The DRA Virtual Cockpit Research Programme, in *Virtual Interfaces: Research and Applications*, AGARD-CP-541, May 1994; Chapter 8-1-8-12.
16. Padfield, G.D., and Hodgkinson J., The Influence of Flying Qualities on Operational Agility, in *Technologies for Highly Manoeuvrable Aircraft*, AGARD-CP-548 FMP, March 1994.
17. Round, P., and Tape, R.F., *Propulsion System Technologies for Thrust Vectoring*, AGARD-CP-409 FMP, April 1986.
18. Fielding, C., Design of Integrated Flight and Powerplant Control Systems, in *Technologies for Highly Manoeuvrable Aircraft*, AGARD-CP-548 FMP, March 1994.
19. Sweetman, B., Fighter agility: The « Bruce Lee » Factor, *International Defense Review*, April 1990.
20. Stoliker, P.C., and Bosworth, J.T., *Evaluation of High-Angle-of-attack Handling Qualities for the X-31A using Standard Evaluation Maneuvers*, NASA TM 104322, September 1996.
21. Canter, D.E., and Groves, A.W., NAS Patuxent River, X-31 Tactical Utility - Initial Results, in *Technologies for Highly Manoeuvrable Aircraft t*, AGARD-CP-548 FMP, March 1994.

22. Gibson, J.C., and Hess, R.A., *Stick and Feel System Design*, AGARD-332 FVP, March 1997.
23. Sarter, N.B., and Woods, D.D., Pilot Interaction with Cockpit Automation II: An Experimental Study of Pilots' Model and Awareness of the Flight Management and Guidance system, *International Journal of Aviation Psychology*, 1994; 4.
24. *Alternative Control Technologies: Human Factors Issues*, NATO-RTO-EN-3, HFM, October 1998.
25. McKay, K., Operational Agility: An Overview of AGARD working Group 19, in *Technologies for Highly Maneuvrable Aircraft*, AGARD-CP-548, 1994; Chapter 20-1 – 20-11.
26. Lutter, R.N., Information Transfer for Improved Pilot Performance, in *Operational Roles, Aircrew Systems and Human Factors in Future High Performance Aircraft*, AGARD-CP-266, October 1979; 6-1-6-6.
27. Kocian, D.F., and Task, H.L., Visually Coupled Systems Hardware and the Human Interface, in W. Barfield and T.A. Furness, *Virtual Environments and Advanced Interface Design*. New York: Oxford Univ Press, 1995; Chapter 6:175-257.
28. Hopper, D.G., Panoramic Cockpit Displays, in *Advanced Aircraft Interfaces: The Machine Side of the Man-Machine Interfaces*, AGARD-CP-521, 1992; Chapter 9-1 – 9-24.
29. Virtual Retinal Display, see website: www.mvis.com.
30. Velger, M., *Helmet-Mounted Displays and Sights*, Boston: Artech House, 1998.
31. Osgood, R.K., Geiselman, E.E., and Calhoun, C.S., Attitude Maintenance Using an Off-Boresight Helmet-Mounted Virtual Display, in *Helmet Mounted Displays & Night Vision Goggles*, AGARD-CP-517, May 1991; Paper No. 14.
32. Geiselman, E.E., and Osgood, R.K., Utility of Off-Boresight Helmet Mounted Symbolology During a High Angle Airborne Target Acquisition Task, in *Proceeding of the SPIE Conference Helmet & Head-Mounted Displays & Symbolology Design Requirements*, April 1994; Vol. 2218:328-338.
33. Rastikis, L., Human-Centered Design Project Revolutionizes Air Combat, *CSERIAC GATEWAY*, Volume IX (1), 1998; 1-6.
34. Arbak, C., King, P., Jauer, R., Adam, E., *Helmet-mounted Display/sight Tactical Utility Study*, Armstrong Aerospace Medical Research Laboratory Technical Report AAMRL-TR-088-022, June 1988.
35. Lind, J.H., and Burge, C.G., Human Factors Problems for Aircrew-aircraft Interfaces: Where should we Focus our efforts? in *Advanced Aircraft Interfaces: The Machine Side of the Man-Machine Interface*, AGARD-CP-521, October 1992; 3-1 – 3-12.
36. Beer, J.M.A., Gallaway, R.A., and Previc, F.H., Near-Threshold Visual Perception and Manual Attitude Tracking: Dual-Task Performance and Implications for Situational Awareness, in *Situation Awareness: Limitations and Enhancement in the Aviation Environment*, AGARD-CP-575, 1996; Chapter 4-1 – 4-11.
37. Adagio, F., Babiak, N., Bollinger, K., and Caposell, C., Virtual Environments: Visualization Throughout the Combat Mission, in *Future Aerospace Technology in Service of the Alliance, Vol 2: Mission Systems Technologies*, AGARD-CP-600, 1997; Chapter B22-1 – B22-6.
38. Martin, W.L., Developing Virtual Cockpits, in *Advanced Aircraft Interface: The Machine Side of the Man-Machine Interface*, AGARD-CP-521, October 1992; 8-1 – 8-8.
39. McCann, R.S., and Foyle, D.C., Scene-linked Symbolology to Improve Situation Awareness, in *Situation Awareness: Limitations and Enhancement in the Aviation Environment*, AGARD-CP-575, 1996; Chapter 16-1 – 16-11.
40. Ercoline, W.R., and Gillingham, K.K., Effects of Variations in Head-up Airspeed and Altitude Representations on Basic Flight Performance, *Proceedings of the Human Factors Society 34th Annual Meeting*, 1990; 1547-1551.
41. Geiselman, E.E., and Osgood, R.K., Helmet-mounted Display Attitude Symbolology: An evaluation of compression ratio, *International Journal of Industrial Ergonomics*, 15, 1995; 111-121.
42. Kraiss, K.-F., and Schubert, E., Comparative Experimental Evaluation of Two Dimensional and Pseudo-perspective Displays for Guidance and Control, in *Visual Presentation of Cockpit Information including Special Devices used for particular Conditions of Flying*, AGARD-CP-201, 1976; Chapter A3-1 – A3-15.
43. Boehmer, S.C., X-31 Helmet Mounted Visual and Audio Display (HMVAD) System, *Proceedings of SPIE Conference on Helmet- and Head-Mounted Display III*, April 1998; Volume 3362:15-24.
44. Geiselman, E.E., and Osgood, R.K., Head vs. Aircraft Oriented Air-to-Air Target Location Symbolology Using a Helmet-Mounted Display, *Proceedings of SPIE Conference on Helmet- and Head-Mounted Display & Symbolology Design Requirements II*, April 1995; Volume 2465:214-225.
45. Geiselman, E. E., and Tsou, B.H., Helmet-display Resident Target Locator Line Symbolology: An Evaluation of Vector Length Depiction, *Proceedings of SPIE Conference on Helmet- and Head-Mounted Display & Symbolology Design Requirements*, April 1996; Volume 2735:233-244.

46. Fechtig, S.D., Boucek, G.S., and Geiselman, E.E., Preliminary Results of the Effective Information Fusion for the Helmet Mounted Display Technologies Program, in *Proceedings for the Third Annual Symposium and Exhibition on Situational Awareness in the Tactical Air Environment*, June 1998; 51-68.
47. Meador, D.P., Geiselman, E.E., and Osgood, R.K., Helmet Display Symbology Development for the JAST/IHAVS Flight Demonstration, *Proceedings of SPIE Conference on Head-Mounted Displays*, April 1996; Volume 2735:39-49.
48. Geiselman, E.E., Development of a Non-distributed Flight Reference Symbology for Helmet-mounted Display use during Off-boresight Viewing, in *Proceedings for the Fourth Annual Symposium and Exhibition on Situational Awareness in the Tactical Air Environment*. Naval Air Warfare Center – Aircraft Division, Patuxent River, MD, 1999; 118-126.
49. Geiselman, E.E., Practical Considerations for Fixed Wing Helmet-mounted Display Symbology Design, in *Proceedings of the Human Factors and Ergonomics Society 43rd Annual Meeting*, 1999; 1187-1191.
50. Geiselman, E.E., Brickman, B.J., Hettinger, L.J. Hughes, T., DeVilbiss, C., and Haas, M.W., Methodology for Evaluating Off-Axis Helmet-Mounted Display Ownship Information, in *Proceedings for the Third Annual Symposium and Exhibition on Situational Awareness in the Tactical Air Environment*, June 1998; 175-182.
51. Previc, F.H., and Ercoline, W.R., The "Outside-in" Attitude Display Concept Revisited, *International Journal of Aviation Psychology*, 1999; 9:377-401.
52. Previc, F.H., Neuropsychological Guidelines for Aircraft Control Stations, in M. Carmody-Bubb (Ed.), in *Proceedings for the Third Annual Symposium and Exhibition on Situational Awareness in the Tactical Air Environment*, Piney Point, MD, June 1998.
53. Johnson, S.L., and Roscoe, S.N., What Moves, the Airplane or the World? *Human Factors*, 1972; 14:107-129.
54. Miller, G.A., The Magical Number Seven, Plus or Minus Two: Some limits on our Capacity for Processing information, *Psychological Review*, 1956; 63:81-97.
55. Reising, J.M., and Aretz, A.J., Color Computer Graphics in Military Cockpits, in H. J. Durrett [Ed.] *Color and the Computer*, CA: Academic Press, Inc., 1987; Chapter 8:151-169.
56. Davis, E.T., Visual Requirements in HMDs: What Can We See and What Do We Need to See?, in J.E. Melzer and K. Moffitt, *Head-Mounted Displays: Designing for the User*, New York: McGraw-Hill, 1997; Chapter 8:207-251.
57. Harris, T.J., Schoole, R.S., Sincerbox, G.T., Hanna, D.W., and Delay, D.G., Holographic Head-Up Display – Phase II, Final Report, JANDIR Report 680709, IBM Corp.:Poughkeepsie, New York, March 1970.
58. Jauer, R.A., and Quinn, T.J., *Pictorial Formats, Volume I. Format Development*, Air Force Wright Aeronautical Laboratories AFWAL-TR-81-3156, February 1982.
59. Warner, D.A., *Flight Path Displays*, Air Force Flight Dynamics Laboratory AFFDL-TR-79-3075, June 1979.
60. Wickens, C.D., Situation Awareness: Impact of Automation and Display Technology, in *Situation Awareness: Limitations and Enhancement in the Aviation Environment*, AGARD-CP-575, 1996; Chapter K2-1 - K2-13.
61. Andre, A.D., Wickens, C.D., Moorman, L., and Boschelli, M.M., Display Formatting Techniques for Improving Situation Awareness in the Aircraft Cockpit, *The International Journal of Aviation Psychology*, 1(3), 1991; 205-218.
62. Parrish, R.V., Williams, S.P., and Nold, D.E., *Effective Declutter of Complex Flight Displays using Stereoptic 3-D Cueing*, NASA Technical Paper 3426, CECOM Technical Report 93-B-E-3. April 1994.
63. Schmit, V.P., Changing System/display Concepts and their Impact on Aircrew Performance, in *Human Factors Considerations in High Performance Aircraft*, AGARD-CP-371, 1984; Chapter 13-1 – 13-11.
64. Hopkin, V.D., Issues in Color Application, in H. Widdel and D.L. Post, *Color in Electronic Displays*, New York, Plenum Press, 1992; Chapter 3.1:191-207.
65. Hardiman, T.D., Dudfield, H. J., Selcon, S.J., and Smith, F.J., Designing Novel Head-Up Displays to Promote Situational Awareness, in *Situation Awareness: Limitations and Enhancement in the Aviation*, AGARD-CP-575, 1996; Chapter 15-1 -15-7.
66. Geiselman, E.E., Post, D.L., Brickman, B.J., Rogers-Adams, B., Hettinger, L.J., and Haas, M.W., Helmet-mounted Display Targeting Symbology Color Coding: Context vs. Population Bias, *SPIE*, Volume 3362, 15-24.
67. Geiselman, E.E., and Post, D.L., Helmet-mounted Display Targeting Symbology Color Coding: An Air-to-air Scenario Evaluation, Helmet- and Head-Mounted Displays IV, *SPIE*, 1999, pp 66-75.
68. Allnutt, R.A., and Tripp, L.D., Color Hue shift during Gradual Onset Gz Acceleration, in *Proceedings of the 36th Annual Symposium SAFE Association*, 1998; 446-453.
69. Calhoun, G.L., Arbak, C.J., and Boff, K.R., Eye-controlled Switching for Crew Station Design, in *Proceedings of the Human Factors and Ergonomics Society 28th Annual Meeting*, 1984; 258-262.

70. Zon, G.D.R., Mooij, H.A., and Bouwens, J., A Non-intrusive Way to Measure Point of Gaze, in *Virtual Interfaces: Research and Applications*, AGARD-CP-541, May 1994; Chapter 11-1-11-8.
71. Stampe, D.M. Reingold, E.M., and Grodski, J.J., Operator Gaze Position Control Interfaces: Investigation of Psychophysical and Operational Parameters, in *Virtual Interfaces: Research and Applications*, AGARD-CP-541, May 1994; Chapter 12-1-12-9.
72. Jacob, R.J.K., Eye Tracking in Advanced Interface Design, in W. Barfield and T.A. Furness, *Virtual Environments and Advanced Interface Design*. New York: Oxford Univ. Press, 1995; Chapter 7:258-288.
73. Calhoun, G.L., Janson, W.P., and Arbak, C.J., Use of eye control to select switches, in *Proceedings of the Human Factors and Ergonomics Society Annual Meeting*, 1986; 154-158.
74. Borah, J., *Helmet Mounted Eye Tracking for Virtual Panoramic Display Systems. Vol. II: Eye Tracker Specification and Design Approach*, Air Force Aeromedical Research Laboratory AAMRL-TR-89-019, August 1989.
75. Nelson, W.T., Hettinger, L.J., Cunningham, J.A., Roe, M.M., Lu, L.G., Haas, M.W., Dennis, L.B., Pick, H.L., Junker, A., and Berg, C.B., Brain-body-actuated Control: Assessment of an Alternative Control Technology for Virtual Environments, *Proceedings of the 1996 IMAGE Conference*, Scottsdale, Arizona, June 1996; 225-232.
76. Nasman, V.T., Calhoun, G.L., and McMillan, G.R. Brain-actuated Control and HMDs, in J. Melzer and K. Moffitt (Eds), *Head-Mounted Displays: Designing for the User*, McGraw-Hill, New York, 1997; 285-310.
77. Jones, K.S., Middendorf, M.S., Calhoun, G.L., and McMillan, G.R., Evaluation of an Electroencephalographic-based Control Device, in *Proceedings of the 42nd Annual Meeting of the Human Factors and Ergonomics Society*, 1998; 491-495.
78. Communication with Ms. Helen Stone, British Aerospace, Sowerby Research Center.
79. Baber, C., Automatic Speech Recognition in Adverse Environments, *Human Factors*, 1996; 38(1):142-155.
80. Williamson, D.R., Barry, T.P., and Liggett, K.K., Flight Test Results of ITT VRS-1290 in NASA OV-10, in *Proceedings of the 15th Annual International Voice Technologies Applications Conference AVIOS '96*, American Voice Input/Output Society, San Jose, CA, 1996; 335-345.
81. Barbato, G., Integrating Voice Recognition and Automatic Target Cueing to Improve Aircrew-System Collaboration for Air-to-Ground Attack, *Proceedings of the NATO Research and Technology Organization System Concepts and Integration Symposium*, Sensor Data Fusion and Integration of the Human Element, Ottawa, Canada, September 1998; 24-1 – 24-11.
82. Jennings, D.L., and Ruck, D.W., Enhancing Automatic Speech Recognition with an Ultrasonic Lip Motion Detector, in *Proceedings of the IEEE International Conf. on Acoustics, Speech and Signal Processing*, Detroit, MI, 1995; 868-871.
83. Salem, C., and Zhai, S., An Isometric Tongue Pointing Device, in *Proceedings of CHI '97*, Atlanta, GA, ACM Press. March 1997; 538-539.
84. newAbilities UCS 1000. See <http://server.seaside.org/9501.html>.
85. Money, K.E., Malcolm, R.E., and Anderson, P.J., The Malcolm Horizon, in *Visual Presentation of Cockpit Information including Special Devices used for Particular Conditions of Flying*, AGARD-CP-201, 1976; Chapter A4-1 – A4-3.
86. Kaczmarek, K.A. and Bach-Y-Rita, P., Tactile Displays, in W. Barfield and T.A. Furness, *Virtual Environments and Advanced Interface Design*. New York: Oxford Univ. Press, 1995; Chapter 9.
87. Beebe, D., Beckman Institute for Advanced Science and Technology, [www/newnewsletter/bn2beebe.html](http://www.newnewsletter/bn2beebe.html).
88. Rupert, A.H., Guedry, F.E., Reschke, M.F., The Use of a Tactile Interface to Convey Position and Motion Perceptions, in *Virtual Interfaces: Research and Applications*, AGARD-CP-541, May 1994; Chapter 20-1-20-7.
89. McGrath, Braden, Tactile Situation Awareness System: Flight Demonstration Final Report, January 1998, unpublished Joint Strike Fighter report. See also: www.tsas.namrl.navy.mil/.
90. Lyons, T.J., Gillingham, K.K., Teas, D.C. Ercoline, W.R., and Oakley, C., The Effects of Acoustic Orientation Cues on Instrument Flight Performance in a Flight Simulator, *Aviation Space, and Environmental Medicine*, August 1990; 699-706.
91. Sorkin, R.D., Wightman, F.L., Kistler, D.S., and Elvers, G.C., An Exploratory Study of the Use of Movement-Related Cues in an Auditory Head-Up Display, *Human Factors*, April 1989; 31(2):161-166.
92. Calhoun, G.L., Janson, W.P., and Valencia, G., Effectiveness of Three-Dimensional Auditory Directional Cues, in *Proceedings of the 32nd Annual Meeting of the Human Factors and Ergonomics Society*, 1988; 68-72.
93. Perrott, D.R., Cisneros, J., McKinley, R.L., and D'Angelo, W.R., Aurally Aided Visual Search under Virtual and Free-Field Listening Conditions, *Human Factors*, December 1996; 38(4):702-715.

94. Nelson, W.T., Hettinger, L.J., Cunningham, J.A., Brickman, B.J., Haas, M.W., and McKinley, R.L., Effects of Localized Auditory Information on Visual Target Detection Performance using a Helmet-mounted Display, *Human Factors*, Sept 1998; 40(3):452-460.
95. McKinley, R.L., and Ericson, M., Flight Demonstration of a 3-D Auditory Display, in R.H. Gilkey and T.R. Anderson, (Eds), *Binaural and Spatial Hearing in Real and Virtual Environments*, Lawrence Erlbaum Associates, Publishers, Mahwah, New Jersey, 1997; Chapter 31:683-699.
96. Ericson, M.A., and McKinley, R.L., The Intelligibility of Multiple Talkers Separated Spatially in Noise, in R.H. Gilkey and T.R. Anderson, (Eds), *Binaural and Spatial Hearing in Real and Virtual Environments*, Lawrence Erlbaum Associates, Publishers, Mahwah, New Jersey, 1997; Chapter 32:701-724.
97. Begault, D.R., and Wenzel, E.M., Techniques and Applications for Binaural Sound Manipulation in Human-Machine Interfaces, *The International Journal of Aviation Psychology*, 2(1):1-22.
98. Nelson, W.T., Bolia, R.S. McKinley, R.L., Chelette, T.L., Tripp, L.D., and Esken, R.L., Localization of Virtual Auditory Cues in a High +Gz Environment, in *Proceedings of the Human Factors and Ergonomics Society 42nd Annual Meeting*, 1998; 97-101
99. McKinley, R.L., Erickson, M.A., and D'Angelo, W.R., 3-Dimensional Auditory Displays: Development, Applications, and Performance, *Aviation, Space, and Environmental Medicine*, May 1994; A31-A38.
100. Cohen, M., and Wenzel, E.M., The Design of Multidimensional Sound Interfaces, in W. Barfield and T.A. Furness, *Virtual Environments and Advanced Interface Design*. New York: Oxford Univ Press, 1995; Chapter 8: 291-346.
101. Ricard, G.L., and Meirs, S.L., Intelligibility and Localization of Speech from Virtual Directions, *Human Factors*, 36, 1994; 120-128.
102. Norman, D., *Readings in Human-Computer Interaction: Toward the Year 2000*, CA: Morgan Kaufman Publishers, Inc., 1995.
103. Seidler, K.S., and Wickens, C.D., Distance and Organization in Multifunction Displays, *Human Factors*, 1992; 34(5):555-569.
104. Calhoun, G.L., and Herron, E.L., Pilot-machine Interface Considerations for Advanced Aircraft Avionics Systems, in *Advanced Avionics and the Military Aircraft Man/Machine Interface*, AGARD-CP-329, 1982; Chapter 24:1-7.
105. Sears, A., and Shneiderman, B., High Precision Touch screens: Design Strategies and Comparisons with a Mouse, *International Journal of Man-Machine Studies*, 1991; 34:593-613.
106. Buxton, W., Hill, R., and Rowley, P., Issues and Techniques in Touch-sensitive Tablet Input, *Computer Graphics*, 1987; 19(3):215-224.
107. Ware, C., and Mikaelian, H.T., An Evaluation of an Eye Tracker as a Device for Computer Input, *Proceedings ACM CHI+GI'87 Human Factors in Computing Systems Conference*, 1987; 183-188.
108. Mulgund, S.S., and Zacharias, G. L., A Situation-driven Adaptive Pilot/vehicle Interface, in *HICS 3rd Annual Symposium on Human Interaction with Complex Systems*, August 1996; 193-198.
109. Repperger, D., Haas, M., Brickman, B., Hettinger, L., Lu, L., and Roe, M., Design of a Haptic Stick Interface as a Pilot's Assistant in a High Turbulence Task Environment, *Psychological Reports: Perceptual and Motor Skills*, 1997; 85:1139-1154.
110. Adams, E.C., Tactical Cockpit – Flat Panel Imperatives, in *Situation Awareness: Limitations and Enhancement in the Aviation Environment*, AGARD-CP-575, 1996; Chapter 9-1 – 9-7.
111. Way, T.C., Martin, R.L., Gilmour, J.D., Hornsby, M.E., and Edwards, R.E., *Multi-crew Pictorial Format Display Evaluation*, Air Force Wright Aeronautical Laboratories AFWAL-TR-87-3047, February 1987.
112. Way, T.C., Hobbs, R.E., Qualy-White, J., and Gilmour, J.D., *3-D Imagery Cockpit Display Development*, Wright Research and Development Center WRDC-TR-90-7003, August 1990.
113. Hatfield, F., Jenkins, E.A., Jennings, M.W., and Calhoun, G.L., Principles and Guidelines for the Design of Eye/voice Interaction Dialogs, in *HICS Third Annual Symposium on Human Interaction with Complex Systems*, August 1996; 10-19.
114. Selcon, S.J., Taylor, R.M. and Shadrake, R.A., Multi-modal Cockpit Warnings: Pictures, Words, or Both? in *Proceedings of the Human Factors Society 36th Annual Meeting*, Atlanta, 1992; 57-61.
115. Bronkhorst, A.W., Veltman, J.A., and van Breda, L., Application of a Three-dimensional Auditory Display in a Flight Task, *Human Factors*, 1996; 38(1):23-33.
116. Hettinger, L.J., Nelson, W.T., and Haas, M.W., Target Detection Performance in Helmet-mounted and Conventional Dome Displays, *International Journal of Aviation Psychology*, 1996; 6:321-334.
117. Hettinger, L.J., Cress, J.D., Brickman, B.J., and Haas, M.W., Adaptive Interfaces for Advanced Airborne Crew Stations, in *HICS 3rd Annual Symposium on Human Interaction with Complex Systems*, 1995; 188-192.

118. Bennett, K.B., *Dynamically Adaptive Interfaces: A preliminary investigation*, USAF Armstrong Laboratory AL/CF-SR-1997-0007, August 1997.
119. Woods, D.D. and Sarter, N. B., Human Interaction with Intelligent Systems in Complex Dynamic Environments, in D.J. Garland and J.A. (Ed.), *Wise Human Factors and Advanced Aviation Technologies*, Dayton Beach, Florida, Embry-Riddle Aeronautical Univ. Press, 1992; 107-110.
120. Parasuraman, R., Mouloua, M., and Molloy, R., Effects of Adaptive Task Allocation on Monitoring of Automated Systems, *Human Factors*, December 1996; 38(4):665-679.
121. Winter, H., Champigneux, G., Reising, J., and Strohal, M., Intelligent Decision Aids for Human Operators, in *Future Aerospace Technology in Service of the Alliance, Vol 2: Mission Systems Technologies* AGARD-CP-600, 1997; B31 – B3-20.
122. Hicks, M., and Ross, I., Aircrew Acceptance of Automation in the Cockpit, in *Advanced Aircraft Interfaces: the Machine Side of the Man-machine Interface*, AGARD-CP-521, October 1992; Chapter 5-1-5.5.
123. Olson, W.A., and Sarter, N.B., As Long as I'm in Control... Pilot Preferences for and Experiences with Different Approaches to Automation Management, in *HICS 4th Annual Symposium on Human Interaction with Complex Systems*, March 1998; 63-72.
124. Haas, M.W., Beyer, S.L., Dennis, L.B., Brickman, B.J., Hettinger, L.J., Roe, M.M., Nelson, W.T., Snyder, D.B., Dixon, A.L., and Shaw, R.L., *An Evaluation of Advanced Multisensory Display Concepts for use in Future Tactical Aircraft*, Armstrong Laboratory Technical Report AL/CF-TR-1997-0049, 1997.

This page has been deliberately left blank



Page intentionnellement blanche

7. SELECTION AND TRAINING

J. Linder* and W Tielemans**

*Aeromedical Center
Swedish Armed Forces
107 85 Stockholm, Sweden

** RNLAf/SGO
Postbus 20703, Binckhorstlaan 135
2500 ES DEN HAAG
Netherlands

7.1 SUMMARY

A "superagility training structure" is discussed and presented. The agile pilot will in the new superagility arena be clearly dependent on both old training principles but also on training where some new interacting factors might come into play:

- *Selection* plays a major role with physiological, intellectual and stress management resources.
- Certain *human constraints* like musculoskeletal, cardiovascular, respiratory, sensory and mental are discussed.
- *Normal life and regular training* do also have a definite implication also on flying.
- *Specific single task training* where a pilot trains crucial abilities like G-tolerance, back/neck-tolerance and hypobarics. Today there is a lack in this area of specific training. Training devices for pilots regarding the sensory system and the cognitive performance are discussed.
- *Specific combined tasks training* where the pilot have to train in a more complex way, e.g. survival training or mission scenarios in a Multi Mission Trainer (MMT).
- *Full ground mission task* where the pilot uses a Full Mission Simulator (FMS) or a Dynamic Flight Simulator (DFS).

Some parts of the Superagility Training Structure have not been a scope in this chapter. They are therefore briefly mentioned here.

Basic flying consists in this context of platform training and tactical training and are the formal parts of flying. Due to the ever-increasing costs of flying, the real portion of a pilot's life in the air most probably will decrease. A different solution could be to get *cheap time* in the air e.g. with a modern propeller-AC.

Tactical/operational flying where *flag-like* exercises are as close to a real war-scenario pilots in general wish to come. As stated above actual flying will be even more expensive and therefore we most probably have to try to find measures to give more and more realistic training concepts. This together with increasing complexity of all systems might in a superagile AC stress the need for air collision avoidance systems (ACAS), ground collision avoidance systems (GCAS), auto recovery or other *fix-it* procedures.

7.2 GENERAL BACKGROUND

Superagile aircraft systems are a new challenging era in aviation history. These aircraft systems will be able to operate within new limits. Some of the areas of the super agile concept have already been explored in flight. Vectored thrust flying has been practised in aircraft such as the X-31, SU 37 and F-18 HARV. New aircraft sensors, sensor-fusion and data-link techniques have made the battlefield much larger than before. The introduction of the night vision aids has also opened a whole new area. Agile weapon systems make the scenario even more intriguing.

The human challenge. How much of a limiting factor will the human become in super agile flight? Will he still have a place in this arena. And if he will operate on board super agile systems will he be able to do so without compromising his health?

Flying these new generation fighter aircraft will be a new experience in a new threat environment. Improved engines will make it possible to fly at high altitude. To avoid adverse weapons from beyond visual range high linear and angular velocities and accelerations will be needed. In close combat situations vectored thrust gives high manoeuvrability at low speed and the super agile pilot will thereby have better possibilities to win and survive.

The flight environment will also hold new threats and players as super agile adversary aircraft with super agile weapons, unmanned aerial vehicles (UAV's) and powerful data links. This will certainly make the battlefield even larger. Although artificial intelligence and remote team members will help to diminish workload, the pilot on board will be a crucial part of the superagility complex.

In this highly complex flight environment the pilot will be submitted to different hazards. He has to be able to perform well under the given conditions. He will have to accomplish his mission and survive to allow him to fly a next one. All this has also to be done without compromising flight safety or the long-term effects on the pilot's health.

Human characteristics. Limitations. In flying, man's limitations become quite visible. Man has his information limits. He works cognitively more in a serial way, i.e. not too many bits of information at a time [1]. Compared to most machines man is structurally fragile. And man is easy to fatigue. In the context of a very multipotent aircraft system it is quite visible that man implies a restriction for the superagile system in some aspects. Yet technological systems without direct human participation have so far proved to be inferior compared to systems where man has his given role.

Strength factors. Adaptability when situations change. This means adaptation of both the cognition and of physiology. Adaptation usually takes some time and involves training. Development of knowledge. Man is a self-educating system where training again is an important factor. The ability to communicate. With intuition and creativity man normally also will outperform technical systems in pattern-recognition.

Flight safety and health risks. In order to find the criteria for selection and retention of super agile pilots one also has to identify and assess the risks of the super agile arena as well as the positive qualities that these pilots will have to have. In an occupational medical approach if these risks cannot be eliminated they have to be isolated. The next step is to give personal protection to those individuals who can meet the criteria of doing the job without compromising health and safety. Briefly some of the main concerns can be mentioned.

High altitude and radiation will stress the issue of oxygenation of human tissues, protective clothing for both body and eyes and survivability in case of ejection.

Acceleration will mean sustained high Gz, other G-vectors, push-pull effects and all these acceleration stresses will be combined with a lot of vestibular peculiarities. And beside the acceleration-effects on the cardio-vascular system, the spine, assisting muscles and joints will be heavily stressed.

Night-vision aids and helmet-mounted displays will both create a focus on flight safety issues and physiological factors. The visual system will also be at danger due to new laser and microwave weapons.

One issue that not by itself is related to the superagile flight is noise. But since there still are a lot of problems in today's flying, this issue must be remembered also in coming superagile systems.

Last but not least the whole spectrum of pilot workload must be remembered. This area can be predicted to be the issue of greatest concern.

Human agility. Superagility with its different aspects and reciprocal relationships is dealt with in detail in other parts of this work. Human agility is a key-factor, which in this context can be seen as an ability to interact with Aircraft agility, Systems agility and Weapons agility. This can be done if a well-developed Pilot-Vehicle-Interface (PVI) gives the right prerequisites. Real Human agility can be reached if selection has been performed optimally and training has been designed after expected scenarios (Figure 7.1).

When man is accepted as part of the Superagility system this can only lead to a revolutionary attitude in how to develop new aircraft systems. These new systems have to be built for and adapted to man. The old attitude to build an aircraft and try to adapt man and make him fit into a technological experiment, is obsolete.

7.3 SELECTION

Selection should stand for the *best possible matching* between physiological and psychological resources versus the given operational requirements.

Introduction. With a classical definition selection refers to any process, whether natural or artificial by which certain organisms or characteristics are permitted or favoured to survive and reproduce in preference to others. It intends to pick out a number of individuals chosen from a group, by fitness or preference. In pilot selection the system tries to identify those individuals who will do best as a pilot in an operational setting.

The topic selection always starts a vivid discussion. Not only is it difficult to identify those individuals. It can also be debated if medical doctors or psychologists are best suited for such a task. In some countries experienced pilots take part in the selection by making interviews. This might be a wise move since these experienced pilots are the criteria themselves.

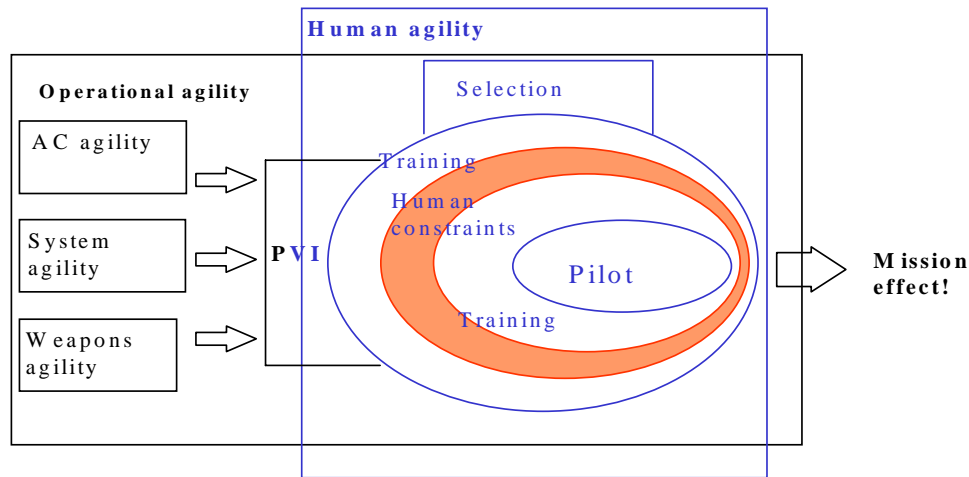

Figure 7.1 Human agility in the Superagility context

Selection has in this time frame a negative connotation for many individuals and groups. The intention, some state, cannot be to exclude candidate pilots in order to create a whole new brand of super pilots. But, others reply, is a fighter pilot performing less than a top athlete?

For some of the arguments consensus can easily be reached. We do need to identify those individuals who are able to fly, and accomplish their mission, without compromising flight safety. Therefore no foreseeable medical conditions should exist that creates a chance of sudden incapacitation. Also agreement can be reached on simple issues. The candidate should have two eyes, two hands and he should be able to hear. But it becomes more difficult if a specific quantity or quality of cognitive intelligence, sensory function or muscle strength, aerobic capacity etc., is asked for.

Part of the reluctance may lay in the fact that it is difficult to identify all these traits and abilities. And prediction becomes more difficult because most air forces select future pilots out of young adolescents who are high school or college students or graduates. At that stage it is difficult to predict future physical and psychological status and performance. Not only the body is not full grown yet, but also personality and character will mature. Moreover in adolescence motivation can still change easily. Fortunately these young men and women can still be trained and shaped well. If well organised, this training is in our own hands.

But even if everybody willingly agrees that selection of pilots is a dedicated task, there seem not to be any profound reevaluation of the selection issues.

Essentially all the criteria, which have been used for decades, still are in use. The prediction of success according to these criteria does not hold for more than completion of the basic flying training [2]. Furthermore most interest seem to focus on the development of automated tests and how to get sufficient numbers of applicants for the flying training [3].

Current selection. In all air forces psychological techniques are used to predict if applicants are the right stuff to become a pilot. Usually the success rate of pilot training is used as a criterion. It would be better to predict the success as a future fighter pilot. Not all people that do well in training end up as the aces at the squadrons. This apparently is difficult to do.

Much at this age has to do with motivation. But some abilities can fairly well be predicted. In the different air forces different selection procedures are used that for a part are due to the different recruiting strategies. Mostly a selection battery is based on a strategy to waste out those individuals with low performance early with low budget techniques. These tests are still more or less paper and pencil tests. They are sensitive. Therefore the possibility is high that also usable candidates are rejected, but as long as the number of applicants is high enough, this is not a major concern.

Than sooner or later more specific and more expensive tests are introduced. Ranging from computer tests to simulators and actual flying. Some of the different test batteries are briefly discussed below.

Current methods. In Canada the "Canadian Automated Pilot Selection System (CAPSS)" is being used after the paper and pencil tests. It is a stand-alone selection device, which provides a measure of complex cognitive abilities and psychomotor co-ordination. The underlying constructs CAPSS is measuring are psychomotor co-ordination, learning rate, multi-task integration and performance under overload. It uses flight simulation technology and is comprised basically of two main elements, an aviation trainer and an analysis centre.

The United States Air Force uses a pre-screening before submitting candidate pilots to a selection board. They first have to pass the selection for officer commissioning. The selection decisions are based on leadership potential, educational achievement, physical fitness and ability based on paper and pencil or computer-based tests. There are no job sampling tests. Carretta and co-workers pointed out that general cognitive ability was the most important factor [4]. Than there is a flight screening consisting of 23 hours of flight. The Air Force Academy policy is slightly different. They accept students not before they passed the flight screening. Since 1993 some experiments have been done with computer based aptitude tests. The selection research is focussed on learning ability. The goal is to develop a multiple test battery that predicts the different specific learning abilities. Analysis of the tests now used show that in predicting success in pilot training verbal abilities relate less than quantitative or spatial abilities.

The French Air Force use aptitude tests, group tests, sports tests, pilot-officer interview and also a link-trainer test.

The German Air Force in addition to similar tests also uses a human centrifuge for evaluation of the G-tolerance of the applicants.

The Swedish Air Force uses pre-screening before applicants are subjected to the pilot selection. The conscript-time has to be finished with a rating as suitable for an officer's career. Applicants also undergo two interviews, one with a flight psychologist and one with a current operational pilot.

The Royal Air Force uses the Pilot Aptitude Test Battery, consisting of five executives tests: Control Velocity Test (CVT, eye-hand co-ordination), Sensory Motor Apparatus (SMA, hand-food co-ordination), Instrument Comprehension (INSB, interpretation of instrument dials), Vigilance (memory needing visual attention) and Digit Recall (short term memory).

Most countries have similar batteries for aeromedical selection. There are always scientific advances in the field of expertise and what are the extra demands of new technologies. For those reasons Nato's Aerospace Medical Panel (AMP), now Human Factors and Medicine Panel (HFM), held a conference in 1996 on Selection and Training Advances in Aviation [5]. Some of the presentations already addressed the challenges of the super agile arena.

Superagile selection. Introduction of super agile flight will not change the validity of old abilities and capacities. All principles that already are valid for current selection processes will also apply for that of super agile fighter pilots. One can also speculate that most of the selection criteria and variables of today might increase in importance. Yet there might be a need for something more or a different focus.

A thorough analysis has to be done of the qualifications and resources a pilot need for the superagility arena. Since these new requirements have not been confirmed and agreed upon this section will bring up some ideas of possible new selection-criteria or suggest stronger emphasis on some old criteria.

The visual system. The visual system plays a most important role in flying. This is very natural since the eyes are the best correcting means. In the agile arena this will be even more important. Some of the new tests will certainly involve the way the visual system works. How to select those capable of much more *cognitive work* while at the same time being able to react properly on *orientation cues*? How to select those with a *true spatial ability*, bearing in mind that most tests of today could not differ between a high intellectual or spatial capacity [6].

The vestibular system and hearing. Rapidly changing G-vectors might have physiological implications speaking for an even more perfectly balanced vestibulo-visual system. New dimensions in testing of the hearing since a good 3D-audio discrimination might be crucial.

Respiratory system. Additional respiratory stress might be the result by positive pressure breathing under high-sustained G [7]. New selection-tests for inspiratory muscle capacity, tests to stage the effects eventual tobacco smoking has had on applicants. And also tests for excluding latent bronchial hyperresponsiveness [8].

Cardiovascular system. It is also an important task to more in detail establish what exact factors constitute a good G-tolerance. Cardiac function during G-stress and pain-provoking factors in high-sustained G might also influence selection.

Musculoskeletal system. A more balanced view on the muscular strength where not only explosiveness and fast-twitch muscle fibres are rewarded. After all when long sorties have to be performed the endurance parameters of the muscular and cardio-vascular system have to be screened and evaluated more.

Specific factors of the back and neck have to be considered in the selection [9]. Among these factors we can predict bone-mineralization, range of motion in relation to strength factors. Condition of vertebral discs and spinal canal.

Cognitive and nervous system. The cognitive ability is truly a question of selection for the superagile pilot. Especially the challenging task to select those with both capacity to work within the *higher* cognitive domain but also extremely *present* in the situation at hand.

Stress resistance will be even more important than in earlier systems. Ways to measure the status and reactivity of the autonomic nervous system will therefore be important. Selection tests where flight stress can be simulated will be appreciated tools. Try to establish a common opinion whether *intuition and creativity* are desirable traits in the superagile world [10]. One could argue for such an opinion since fights including BVR, rapidly changing scenarios, uncertainties of threats etc. indicate the value of these traits.

Situational awareness in the superagile world is essential. Weeks et al [11] pointed out that in F-15 pilots, experience (flight hours) was the best predictor. And taken that in account general cognitive ability, divided attention, spatial reasoning and working memory were most important.

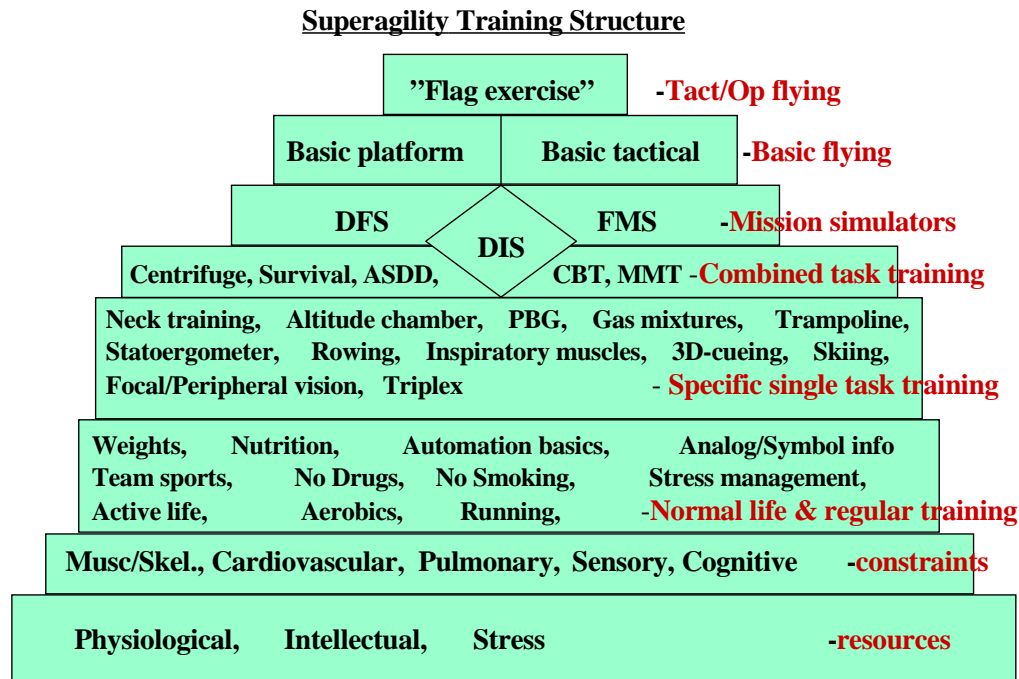

Fig 7.2 The Superagile Training Structure

7.4 TRAINING

Training has to be both basic and specific to give the best prerequisites for the pilot to handle the superagile situation.

Human resources and constraints. These are their contrasts. In *selection* we focus on *human resources* while in *training* we often try to overcome or *reduce effects of human constraints* and reach or move human limits, which might be possible to reach.

Superagility training structure. Training for this superagile environment has to be performed for different reasons. Firstly man will more clearly than ever be the restricting factor. Secondly flying time will be so expensive that ordinary training sorties will have to be supplemented with a variety of other training regiments. Thirdly the rivalry between spatial orientation and tactical awareness will make it necessary to train both specified single tasks and also combined mission-like tasks.

Training could be divided in training to reduce the human constraints (physiological and mental training) and training which in some respect goes with the right PVI-format. This latter training will give familiarity with cockpit instruments and facilitate "pattern-recognition" when it comes to real flying. The training will aim at strengthening the human capability to withstand mental and physiological threat in a superagility environment.

The superagility training could also be seen as a "training structure" which has to be worked through (Figure 7.2). In this superagility training structure we have earlier discussed the human resources which are truly valid factors in the selection. In the following the human constraints and different parts of training are discussed.

Human limitations (Internal constraints). The human limitations in this scenario force us to focus on many training issues. Some of the factors, which could be considered to be human constraints in the superagile world, are mentioned below.

Cognitive function. The cognitive function of the pilot might not be a constraint in itself. But a lot of sensory information has to be processed in higher cognitive areas. And then we have an easy set-up for a conflict between the need not to lose the orientation in airspace and the need for effective use of higher cognitive functions according to the demands of the sortie. In addition physiological stress on the human system and perceived mental stress will reduce effectiveness. In conclusion one can state that there will be even more emphasis put on situational awareness (SA).

Sensory function. Signals to our 5 senses are crucial to orient ourselves in the agile world. Since flying is something so different from permanent residing on ground, which we are built for, man has to watchfully observe a lot of rather simple information. This information serves only the purpose of body orientation in the airspace.

The vestibular system is sensible to different G-vectors, rotations, and translations. This system will be more stressed than ever before and it has to be adapted and if possible made less prone to react on unusual vestibular stimuli.

The visual system receives orientation cues but is also used for cognitive information. We need better and more intuitive information for spatial orientation, because the visual system is by far the most important sensory system and will also be the most important in flying. In years to come we will have a definite risk for overloading the visuals with *important* information on e.g. HMS/HMD: s, and VR-systems. The greater part of this information has to be perceived, interpreted, compared with elements in the long memory storage before any decisive action can be with taken. The conflict is given!

The hearing system gives orientation cues, better for horizontal than vertical information. An increasing importance is foreseen for the hearing system since e.g. 3D-audio cueing is to come thereby hopefully shortening the OODA-loop (observe, orient, decide, act) for this sensory system.

The somatosensory system has up till now been a simple sensory system in the context of flying. It gives orientation cues. There are possibilities to artificially reinforce some of these cues, like tactile suits. But one has to remember that the system is one of fast adaptation (reduced sensitivity) while stimulated.

Musculoskeletal function. High acceleration forces especially for back and neck, more if X-tra head worn equipment is used put a lot of stress to this system. In addition stress will be caused by static postures due to harness restraints and certain demanding mission profiles like low-level flying [9]. Superagile flying will be demanding on both gross-muscular strength and fine-tuned motor function. It will also stress the need for a superb ergonomic cockpit.

Cardiovascular function. Cardiovascular function is sensitive to acceleration forces, mainly head to foot (+Gz). The heart itself is a pressure generator and integrated electromechanical device sensitive to acceleration as well as is the vascular bed of the central nervous system. Peripheral vascular beds seem also to be heavily affected by acceleration forces and thereby prone to pain reactions, e.g. arm pain [12].

Respiratory function. Respiratory function is sensitive to atmospheric pressure changes and different gas mixtures. Additional oxygen supply at times with overpressure will be needed to match the superagile envelop. To secure CNS function and facilitate inspiration pressure breathing during G (PBG) will be used. This will reveal the deficiencies in the human respiratory function.

Normal life and regular training. As individuals in a modern high technological society we need to broaden ourselves in relation to e.g. the information technology revolution. Yet this increasing competence has to be matched with a physically active life to stay healthy. This may contain an inherited contradiction since many youngsters who are good at computers do not like physical activity too much.

Cognitive training. It will be important to have an increased knowledge of and possibility to handle mental stress. Since automation will become part of every man's day understanding of automation-principles will be important. One specific area of concern for most high-tech professionals and especially for the superagile pilot will be to find the right way to work with symbolic information at the same time analogue information is presented to the person or pilot. The saying *right information in the right format* will be more and more important. Presentation principles have to be looked carefully upon.

Life style aspects. Every pilot has to consider his personal eating- habits, sleeping-patterns, drugs and so on. And he must be physically active with the right balance between endurance and strength training.

Cardiovascular training. Pilot selection criteria like body-type, heart-cerebral distance, vagal and sympathetic nerve tone will be more important. It has been emphasised that it is not acceptable to perform extreme marathon training when flying high performance fighters [13]. Yet it must be pointed out that distances up to 5-7 miles x 2-3 per week will be of no harm if the training contains high intensity peaks.

A well-conditioned cardiovascular system has a great importance when considering multiple sorties and limited possibilities for rest as in a war situation. A variety of different sports can be performed to achieve needed goals.

Musculoskeletal training. In recent years it has been a focus on strength training. A sufficient muscular capacity will still be an important factor in superagile flying but one has also to focus on the supporting tissues like back and neck with its bony structures, ligaments and discs. The way of modern living including working conditions where one often sits in front of a desk or a laptop is fundamentally wrong considering the heavy work, static or dynamic, which a high performance pilot sometimes has to exert.

A young pilot of tomorrow might as well have a suboptimal bone mineralization [14]. To adapt to physical requirements he or she will have to train the musculoskeletal system over months or even years to correct deficiencies.

Superagile fighters might also add systems for the pilot which will increase the load on the neck/back. Device integrated to the helmet will stress these structures. Already today there is evidence that the ageing process of the neck of high performance pilots is accelerated compared to age matched controls [15]. The clinical significance of this is unclear.

Specific single task training. This type of training will strengthen some specific abilities the pilot have to show in the superagile cockpit. Still this training will be performed outside the cockpit.

Cardiovascular and muscular training. To withstand high acceleration forces (normally +Gz) is a primary goal. This will also include the area of negative Gz or the *push-pull* phenomenon [16]. Factors important are actual G-experience, conditioned cardiovascular reflexes including both central adaptive mechanisms and local training effects on certain vascular areas such as the arms, to prevent arm pain. There are known device, which can be used for improvement in these areas like the statoergometer of Russian origin, rowing machines, downhill skiing, trampoline and for arm pain a protective arm-sleeve[17].

Sensory training. Of the 5 senses the human have for information, the visual system is by far the most important in flying. To be able to move in 3 dimensions unlike the situation on ground, the pilot in his AC has to overcome a lot of erroneous signals given from e.g. the vestibular and the somato-motor systems. A great deal of work has therefore to be focused on training for the visual apparatus. Orientation information simultaneously presented with a high flow of tactical information will or rather must be given in two different formats so the pilot can work in parallel with the information. This is very important since information overload of the pilot is an immediate threat in superagile flying.

Night vision capacity will be crucial in superagile flying. NV devices will certainly improve when sensor-technology becomes even better. Acuity and wide field of view (WFOV) for these devices have to approach day-light conditions until synthetic images have become a reality.

The vestibular system has to be adapted to a variety of new movements in flying like yaw, side slipping, translations and unusual velocity-vector movements compared to regular flying.

In addition to the visual system there are now efforts to also include the hearing system into the informational inflow. Then we must have in mind that pilots in earlier stressed situations (e.g. Vietnam war) have had the tendency to shut off information they have considered to be annoying and distracting rather than helping.

With 3-D hearing information there will be a possibility to keep track of much more auditory information compared of today's situation. Yet the risk for informational overload of the pilot will always be critical.

The sensory training can contain formal sensory training outside the cockpit like the Triplex and Trampoline used in e.g. Germany and Sweden.

Body rotation is known to create a deterioration of both postural and manual task control [18].

It has also been shown that fighter pilots have better postural control than do helicopter pilots have [19]. Vision seems to play a major role in this respect since vision improves the precision in control of landings for trampolinists [20,21].

This has led to an introduction of trampoline-training for student pilots. One claims also that there are other skills that can be learnt except spatial orientation awareness, e.g. a natural way to learn how to perform an anti-G straining maneuver.

Training of the spatial ability like 3D-cueing and also exercise aimed for training focal and peripheral vision might be of specific value.

Respiratory training. Training has to include hypobaric exposition with possibilities to experience hypoxia and preferably also rapid decompression training.

With high performance AC in the inventory it has been shown that positive pressure breathing during G (PBG) gives a definitive advantage. Intrathoracic over pressurisation of up to 70 mmHg has been tested. The overall consensus today seem to be around 50-60 mmHg at 9G [22]. The ideal pressure schedule in relation to G is still under debate. The advantage of PBG seems to be an increase in G-endurance. One important factor for this might be the decreased load with PBG for the inspiratory muscles. These muscles are weak considering the normal physiology at 1 G. In this situation the lungs are almost passively filled with air as a function of the flattening diaphragm following the abdominal volume displacement acting in the same direction as the +Gz-vector.

In the high-G situation there is an urgent need for the auxiliary respiratory muscles above the lungs to try to counteract the Gz-vector in the inspiratory phase and *lift* the lungs to get air. Activated G-suit will tend to counteract the filling process of the lungs by abdominal upward displacement during G. PBG seems to give a substantial help in this respect.

Device needed for the respiratory system will be altitude chamber, PBG-systems where especially the inspiratory phase of the cycle can be trained.

Combined task training. The type of training is much more functional and has a clear aim to be more directly useful for flying. This will also mean that there will be specific devices developed to be means to prepare the pilot for e.g. the cognitive work or to be able to withstand specific physiological stresses.

Cognitive training. Computer Based Training (CBT) and Multi Mission Trainers (MMT) are needed tools to give fundamentals of AC systems and of the superagile arena. Cockpit outlay, display arrangement and content as well as familiarisation with buttons and switches make a good start for actual flying. Instructors can guide and interact with the trainee.

A broad knowledge of the AC, systems, weapons and the tactical and operational facts of the situation are crucial. One of the biggest problems is the informational load on the pilot. Therefore information systems, which are more *intuitive*, have to be developed. With increasing information to the pilot, decision support systems will come. Many of these systems will be automated to some extent. Still there will always be a need for the pilot to know the *actual state* of the automated process.

Sensory training. The visual and vestibular systems can be regarded as the most stressed sensory systems in the superagile world. Both adaptation to unusual stimuli and also suppression of unwanted side effects will be crucial. Both simple gyro-simulators and advanced disorientation trainers are useful tools. There might also be a possibility to use a modern dynamic flight simulator (DFS) for spatial disorientation training.

Cardiovascular and muscular training. High-sustained G and G-peaks of 9 or more are inevitable effects of the superagile world. The absolute need for an adapted cardiovascular system and muscular strength to be able to fight in this arena is already known with today's AC systems. High-speed BVR-scenarios stress this even more. The human centrifuge with sufficient G-onset rate is a basic tool for this. Different types of centrifuges from free-swinging single-gimballed centrifuges to modern dynamic flight simulators with both roll- and pitch-control will be used. With the more modern devices even push-pull training can be performed.

Survival. Pilots must also be prepared to leave their AC in case of a malfunction or an unwanted outcome of an engagement. Summer- and winter-survival training are ultimate combined training regimes where most everything from the Superagility Training structure can be applied.

7.5 INTEGRATED TRAINING AND SIMULATION

Integrated training, where most factors that have an implication in flight are used, is an intriguing task. And this is when *simulation* comes into play. Evidence is building up that simulation is a more and more valuable complement to actual flying. Though most evidence is based primarily on data from experienced pilots [23].

There is a justified need for *realism* and complexity in this form of training. The more realistic the simulation is the more will it bring forward actual stressors from real flying. In simulation both cognitive and physiological stressors are used.

In addition simulation can also be focused on decision-making and performance under all kinds of stress. In a recent issue of Aviation Week [24] one can find the trends in simulation. Less costly, optimisation of education tools (CBT, WTT, FMT), realistic *flying* (advanced imagery, VR, photo-realistic visual scenes, interaction) and last but not least an individualised pilot-training.

Coming to this part of the training, more complex device almost up to real flying have to be used. The best possible right format will then be given to produce all different factors including stress.

Due to the ever-increasing costs of flying-time simulators, though they often are very expensive, have to be used. And knowledge and experience might have to emanate more from simulator-experience in the superagility environment even though it is of utmost importance to fly.

Therefore also distributive interactive simulation (DIS) will be used more, where ACs *powered* and data-linked with each other and different simulator systems in a network will *play* together.

Flight simulation. Since the visual system by far is the most important in flying, much emphasis has been put on making visual realism in flight simulation. But in the superagile arena there is also a need for expressing the information loads and the physiological stress.

Visual simulation. The best visual simulators of today are domes or full- mission- simulators (FMS). They are static but they provide almost unlimited field-of-view (FOV). Domes usually are very big 20-40 ft in diameter and the image can be projected at an infinite distance. With head- and eye- trackers it is also possible to have an area of interest where the image-resolution is very good. The drawback can be motion sickness in inexperienced and individuals prone to this "visual overflow" of information [25]. We now also see the rapidly oncoming head-worn VR systems, which might replace the dome-solutions.

The visual systems can be used in combination with so called *G-seats* where the tactile as well as the proprioceptive systems can be stimulated by e.g. shaker system, retractable harness and inflatable seat-cushion [26].

Motion based system. Though many civilian airlines have a need for a 6 degree-of-freedom (6DOF) device there is not so much need for that in the military applications. G-forces are not possible to create to a necessary degree. In addition most military simulators where motion bases were linked to each other have been disconnected since there were a lot of problems with visual and other sensory mismatching, causing a frequent tendency to motion-sickness.

Dynamic flight simulators. These gimballed centrifuges are a clear development from the centrifuges with a free-swinging gondola. Most of them have controllable pitch- and roll- axis. Together with a G-onset capability of 6-10 G/sec the devices should be capable to give the superagile pilot most of the experienced G-vectors in a superagile AC. In addition there is hope that a very good visual system and a closed-loop control system could give the dynamic flight simulators more realistic *flying characteristics*.

Yet there are some precautions to that. For vestibular reasons the pilot could not move his head too much since he then will have heavy vertigo due to coriolis-effects. To minimise these problems most dynamic flight simulators have an arm-length of 25 ft or more.

Existing or oncoming facilities are situated in: US, Singapore, Germany, France, Japan, Sweden and UK [27].

The Combined Acceleration Flight Simulator (CAFS). This is a concept from the early '90s (USAF Armstrong Lab [28]). The concept involved a multi-gimballed cab suspended by electromagnets in a large circular loop with a radius of over 200 ft. Together with a wide-FOV visual system and man-in-the-loop control this simulator would have minimised Coriolis' effects and given an outstanding possibility to simulate almost everything in the superagility arena.

7.6 HUMAN CENTERED PILOT-VEHICLE-INTERFACE (PVI)

For optimum training transfer, integrated training is conducted on a specific weapons system/PVI. There are obvious interactions between the PVI and training requirements. With a well designed PVI some basic tasks should require less training and training effort can be focused on the more complicated tasks and on optimising information management strategies. The pilot vehicle interface (PVI) must in the future be a lot more adapted to the human. That means the PVI has to be built according to a human centered design protocol. Some of these factors should be:

- Ergonomic cockpit
- Simple platform to fly (carefree maneuvering)
- Clear distinction between displays for orientation purpose and displays for tactical awareness.
- The right information in the right format at the right time (no information-overload).
- Logic decision support.
- Pilot-monitoring systems with situation feedback on the information-, decision- and control systems (pilot-state adaptive systems).
- The *right* degree of automation.
- Very good escape system and protective equipment.
- *Ideal* pilot-warning system.

Ideally, the PVI has also to be as operational as possible in advanced simulators like FMS and DFS. These two very "much-alike" AC simulators should also ideally give a lot more physiological and mental stress compared to the more cognitive trainers like CBT and MMT, and will facilitate training.

7.7 REFERENCES

1. Wickens CD. *Engineering Psychology and Human Performance* (2nd ed) New York: Harper-Collins, 1992
2. Cox RH. *Psychomotor Screening for USAF Pilot Candidates: Selecting a Valid Criterion*. Aviat Space Environ Med 1989 Dec; 60(12):1153-56
3. Turnball GJ. *A Review of Military Pilot Selection*. Aviat Space Environ Med 1992 Sep;63(9):825-30
4. Carretta TR. et al. *A Comparison of Two USAF Pilot Aptitude Tests*. Aviat Space Environ Med 1998 Oct;69(10):931-35
5. AGARD-CP-588, *Selection and Training- Advances in Aviation*. May 1996
6. Carretta TR. and Ree MJ. *USAF Pilot Selection Tests: What is Measured and What is Predictive?* Aviat Space Environ Med 1996 Mar; 67(3):279-83
7. Bain B. et al. *Respiratory Muscle Fatiguing during SACM*. Aviat Space Environ Med 1997 Feb; 68(2):118-25
8. Hartmann CM. et al. *Lung Function Requirements in Flying Duty, the Problem of Bronchial Hyperresponsiveness in Military Aircrew*. Eur J Med Res 1999 Sep 9;4(9):375-8
9. RTO Technical Report 4, *Cervical Spine Injury from Repeated Exposures to Sustained Acceleration*. Feb 1999
10. Ben Nun A. Former CIC, IAF (pers comm)
11. Weeks JL. et al. *Advances in USAF Pilot Selection*. AGARD-CP-588, May 1996
12. Green ND. *Arm Arterial Occlusion Cuffs as a Means of Alleviating High +Gz-associated Armpain*. Aviat Space Environ Med 1997 Aug; 68(8):715-21
13. Epperson WL., Burton, R.R. and Bernauer EM. *The Influence of Differential Physical Conditioning Regimens on SACM Tolerance*. Aviat Space Environ Med 1982 Nov; 52 (11): 1091-97
14. Heaney RP. *Pathophysiology of Osteoporosis*. Am J Med Sci 1996 Dec; 312(6): 251-6
15. Petré-Mallmin M. and Linder J. *Cervical Spine Findings on MRI in Asymptomatic Experienced Fighter Pilots and Controls and in Young Fighter Pilots*. Aviat Space Environ Med, 1999 Dec 70 (12):1183-88
16. Banks RD. et al. *The Push-pull Effect*. Aviat Space Environ Med 1994 Aug; 65(8): 699-704
17. Linder J and Hörding G. *Arm Pain in a 9G Aircraft*. Proc ASMA Conf 1999,p86
18. Previc FH. et al. *The Effects of Background Visual Roll Stimulation on Postural and Manual Control and Self-Motion Perception*. Percept Psychophys 1993 Jul;54(1):93-107
19. Kohen-Raz R. et al. *Postural Control in pilots and Candidates for Flight Training*. Aviat Space Environ Med 1994 Apr;65(4):323-6
20. Lee DN. et al. *How do Somersaulters Land on their Feet?* J Exp Psychol Hum Percept Perform 1992 Nov;18(4):1195-1202
21. Bardy BG. and Laurent M. *How is Body Orientation Controlled during Somersaulting?* J Exp Psychol Hum Percept Perform 1998 Jun;24(3):963-77

22. Pecaric M. and Buick F. *Determination of a Pressure Breathing Schedule for Improving +Gz-tolerance*. Aviat Space Environ Med 1992 July; 63(7):572-8
23. Bell HH. and Waag WL. *Evaluating the Effectiveness of Flight Simulators for Training Combat Skills*. Int J of Aviat Psychol 1998;8(3):223-42
24. *Simulation and Training*. Av Week and Space Tech 1999, Nov 29
25. Kennedy R. and Lillenthal M. *Simulator Sickness: Incidence of Simulator After-effects in Navy Flight Trainers*. In the Proc of The SAFE Assoc., 1984
26. Kron G. *Advanced Simulation in Undergraduate Pilot Training: G-Seat Development*. AFHRL-TR-75-59(III), 1975b
27. Albery W. *Human Centrifuges: The Old and New*. In the Proc of the 36th Ann Symp of the SAFE Assoc. Phoenix AZ, 14-16 Sept 1998
28. Raddin J. *Concept Feasibility Analysis for a Large Radius Track-Centrifuge*. Brooks AFB TX, USAFSAM-TP-90-3, June 1990

8. SIMULATION

W. Albery

Air Force Research Laboratory
AFRL/HEPA
2800 Q Street, Bldg #824
Wright-Patterson AFB OH 45433-7947, USA

8.1 CHARACTERISTICS OF THE SUPERMANEUVERABLE ENVIRONMENT

Supermaneuverable flight is characterized by high angle-of-attack flight and motion in the longitudinal, or x (chest-to-back), lateral y (side-to-side), and vertical, or z (head-to-toe) axes. These three aircraft axes are shown in Figure 1. The high agility flight environment is also characterized by slightly lower +Gz levels, shorter +Gz durations, very high G onset rates, high angular rates, and multiple axis G stress as compared to the conventional fighter environment. Only a few jet aircraft are currently capable of this type of flight. Those aircraft that are equipped with thrust-vectoring jet engines (Su-27, Su-37, Harrier, X-31, F-22) are capable of directing thrust in a direction other than along the longitudinal axis of the aircraft. By directing the thrust up and down, the aircraft becomes “agile” in the pitch axis. The F-22 has pitch axis thrust-vectoring. When the thrust is directed laterally, an aircraft has the capability to yaw while traversing along a longitudinal velocity vector. The X-31 has both pitch and yaw axis thrust vectoring. Maximum G levels, angular velocities, and angular accelerations of supermaneuverable aircraft are shown in Table 1.

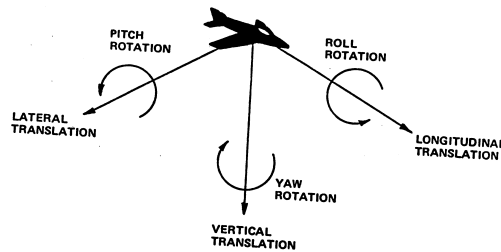

Figure 1. Three Aircraft Axes Plus Rotations about Those Axes

Flight Parameter	F-16 Class Fighter	Supermaneuverable Aircraft
Maximum G	9	7.5
Angle of Attack in Flight	<30°	>60°
Maximum Angular Velocity	<60°/sec	>120°/sec (complex axes)
Ability to Point	-Gz (bunting), -1 Gz	±Gx, ±Gy, ±Gz

Table 1. Agile Flight vs. Conventional Flight Parameters

8.2 SENSING MOTION AND FORCES FOR SIMULATION

The visual system is the most important sensory system for supermaneuverability simulation. The foveal (central) and ambient (peripheral) visual systems are used, but the peripheral visual system gives the brain the strongest motion cues. This is simply illustrated in demonstrations ofvection. Linearvection is the sensation of motion in a linear fashion. The sensation is stimulated by motion of the visual scene in the peripheral field even in the absence of motion. The typical example is the sensation of linearvection one gets while stopped in a car at a red light. The car next to yours begins to creep forward but your vehicle is stationary. You sense movement of the car in your peripheral vision as the adjacent car moves forward. Your sensation is that your neighbor is stationary and that you are beginning to creep backwards, possibly bumping into the car behind you. You immediately hit the brake only to discover it is your neighbor, and not you, who is moving. This example illustrates the power of the peripheral visual system to elicit motion cues. Circularvection is the same as linearvection but in the circular direction. One can view a revolving visual

scene (computer-generated imagery, vertical bars, etc.) and become convinced they are turning, although we are stationary and the scene is moving [15].

Flight simulator manufacturers have taken advantage of this phenomenon and put as wide a field-of-view (FOV) visual display in flight simulators as they can. The other motion sensors that are important in simulating motion and force also include the vestibular and somesthetic systems. The vestibular system includes the semicircular canals and otoliths; the human has a set on each side of his head known as the inner ear. The canals include three orthogonal rings filled with endolymph and are exquisitely small (canal radius = 1.5mm). The canals sense angular accelerations. The otoliths are the linear acceleration transducers of the brain. They sense linear acceleration in the horizontal (utricle) and vertical (sacculle) planes [15]. The vestibular system is stimulated by motion platform systems including the 6-post system and the centrifuge. The G seat can provide some stimulation of the vestibular system, but its forte is stimulating the somesthetic system, which includes the tactile (touch) system as well as proprioception (muscle spindle receptors, joint angle feedback). By virtue of moving the seat pan, backrest, and lap belt, the G seat can stimulate the tactile and proprioceptive receptors. It is believed these receptors have the highest bandwidth and, thus, react the quickest to stimulation. Even the vestibular system reacts to a motion stimulus faster than ambient vision [6].

An important consideration in the use of motion platforms and G seats for motion and force simulation is the coordination of cues. If significant delays exist between the visual and motion cues, the trainee will not have a positive training experience, can possibly get motion sick, or have negative transfer of training to the aircraft [7].

8.3 CURRENT TECHNIQUES/DEVICES AVAILABLE FOR SIMULATION

8.3.1 Visual Simulations

Perhaps the best static visual simulators for agile flight are the domes. These spheres provide almost unlimited FOV. The stationary cockpit sits near the center of the sphere and computer-generated imagery is projected onto the surface of the sphere, or dome. In order to give the illusion of motion, the real image that is projected on the dome is at a distance where the eyes accommodate to infinity; the domes are usually 20-40 feet in diameter so that the image is at least 10 feet away from the observer. Many smaller, static, visual systems use virtual images that are developed by observing a TV or screen through optics that collimate the image and present it at infinity (greater than 20 feet away). Many pilots throughout the world have been trained in these devices. The main drawback is that trainees can develop simulator sickness, which is characterized by nausea and sometimes flashbacks [2]. This may occur because visual cues are not reinforced with motion cues in static simulators according to some theorists.

8.4 MOTION BASED SYSTEMS

Whereas static flight simulators (domes, virtual displays) can create the dynamic environment of the agile aircraft very adequately, earth-bound motion simulators can only emulate the multi-axis environment of the supermaneuverable aircraft. These motion simulators include 6-post motion platforms, G seats, 5 degrees of freedom systems, and human centrifuges. The degrees of freedom of motion and the associated terms for the direction of the force are shown in Table 2.

Actuator	Position	Velocity	Acceleration
Heave	+39", -30"	+24"/sec	+0.8 G
Sway (lateral)	+48"	+24"/sec	+0.6 G
Surge (longitudinal)	+48"	+24/sec	+0.6 G
Pitch	+30°, -20°	+15°/sec	+50°/sec ²
Roll	+22°	+15°/sec	+50°/sec ²
Yaw	+32°	+15°/sec	+50°/sec ²

Table 2. Typical Motion System Characteristics (Nonsimultaneous) (Ref Figure 2)

8.4.1 Six-Post Systems

The motion and force of flight has been simulated for over 30 years by the 6-post motion platform [2]. A typical 6-post motion platform is shown in Figure 2. This type of system provides the onset acceleration cues along and about the three aircraft axes. Since one attribute of this type of motion platform is that it is synergistic, the platform is supported by six active hydraulic actuators. The 6-post is essentially a hydraulic position servo driven by commanded leg or actuator lengths computed by a motion system mathematical model. A typical system has 60-inch stroke of the posts and can carry a cockpit and visual system on top of the platform weighing up to 12-15 tons. Typical 6-post motion capabilities are shown in Table 2. Six-post systems can deliver motion cues in all 6 degrees of freedom; however, they have several drawbacks. First, they have limited capability because of their physical constraints and cannot replicate a velocity or acceleration for more than a few seconds, at most. Second, they must “washout” a movement when the legs approach their maximum stroke; that is, they must stop moving towards the limit of a leg or legs and subliminally return the platform to a neutral or nominal position to react to the next motion cue. Herein lies the Achilles Heel of the 6-post system. Many of the early platforms were evaluated with cockpits and visual systems and decommissioned after complaints of visual-motion mismatch and poor motion washout algorithms. Very few training flight simulators in the Air Force and Navy now have motion platforms.

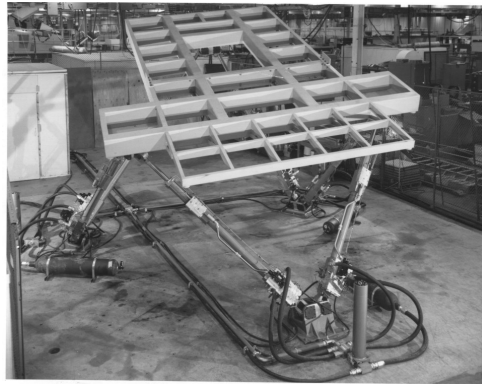

Figure 2. Six Degrees of Freedom Motion System

8.5 G SEAT

If the 6-post motion system has motion limitations based on the physical constraints of the legs (60-inch stroke), the idea of sustaining a motion or force led to the development of the “G seat.” The G seat is an ejection seat facsimile that, by all outward appearances, looks like an aircraft ejection seat [3]. The seat, however, generally has an active (movable) seat pan, backrest, lap belt, harness, and seat shaker system. A typical G seat is shown in Figure 3. The original idea of the G seat was to use the device to sustain the onset motion cues developed by the motion platforms. Since the 6-post system can deliver a motion cue for only a few seconds, it was believed the G seat could sustain the original onset cue by movement of the backrest, seat pan, lap belt, or combinations of these components. A few of these simulation devices still exist. The typical motion characteristics of a G seat are shown in Table 3.

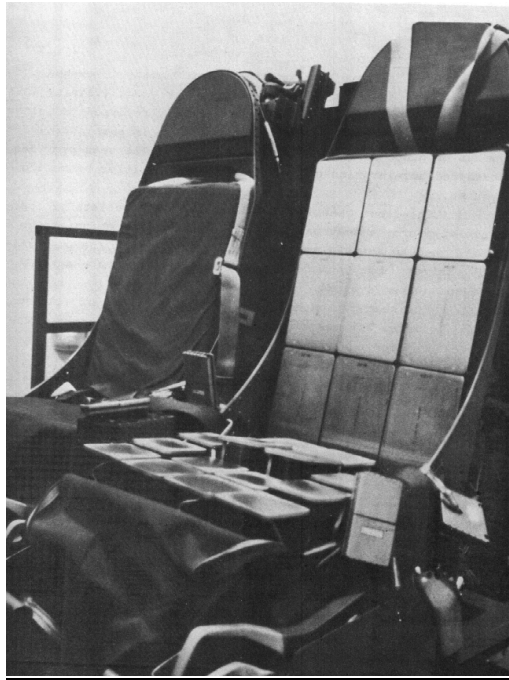

Figure 3. G Seat (seat cover removed)

Seat	Active seat pan and backrest, 10 Hz bandwidth response
Anti-G Suit	5 psi max with vacuum exhaust to enhance cues
Seat Shaker	0-40 Hz, $\pm 0.25''$ amplitude (0.5 G)
Lap Belt	Active, loosens under +Gz, tightens (-Gz)

Table 3. G Seat Component Characteristics

8.5.1 Five Degrees of Freedom Systems

Another motion simulator capable of producing cues, in at least 5 degrees of freedom systems is the Large Amplitude Multi-mode Aerospace Research Simulator (LAMARS) at the Air Force Research Laboratory. The gondola is capable of motion in all degrees of freedom systems except longitudinal ($\pm x$) translation [9]. The motion and G characteristics of the LAMARS are shown in Table 4.

Axis/ Degree of Freedom	Displacement	Velocity	Acceleration
Vertical	± 10 ft.	± 13 ft./sec	± 3 G
Lateral	± 10 ft.	± 10 ft./sec	± 1.6 G
Pitch	$\pm 25^\circ$	$\pm 60^\circ/\text{sec}$	$\pm 400^\circ/\text{sec}^2$
Yaw	$\pm 25^\circ$	$\pm 50^\circ/\text{sec}$	$\pm 200^\circ/\text{sec}^2$
Roll	$\pm 25^\circ$	$\pm 60^\circ/\text{sec}$	$\pm 460^\circ/\text{sec}^2$

Table 4. LAMARS Motion Characteristics

8.5.2 Human Centrifuges

The human centrifuge offers the most promise for ground-based supermaneuverable aircraft simulation. Gimballed centrifuges, those with an active cab and fork (Figure 4), can produce accelerations in several axes while turning. The clever centrifuge programmer can reproduce most agile aircraft maneuvers in terms of angular velocities, transient accelerations, and sustained accelerations. When coupled with a wide FOV visual system, the simulation can be very compelling. Some of the centrifuges include:

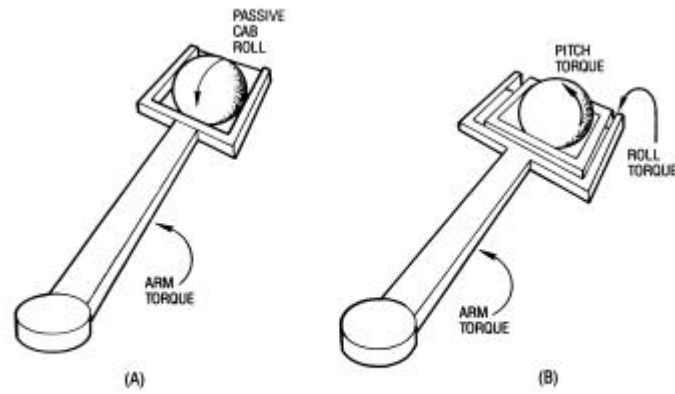

Figure 4. Gimbaled Centrifuge

- a) The Dynamic Environment Simulator (DES): The DES is a three-axis, man-rated centrifuge located at Wright-Patterson AFB OH (Figure 5). The DES has a dual gimbal at the end of a 19-foot arm. The cab is 10 feet in diameter and is capable of full 360° rotation, as is the fork, which contains the cab. The performance characteristics of the DES are shown in Table 5. The DES has been used to produce multi-axis accelerations. Because of its gimbal configuration, the DES can develop sustained acceleration in two axes only. If the subject is seated in the tangential direction of rotation, by rotating the cab on its axis as the main arm turns, the subject can experience $\pm G_z$ and $\pm G_y$. Only small levels of G_x can be reproduced in this configuration because of the slow onset/offset capability of the DES (1.0 G/sec). If the fork is also rotated (pitched) in this seat configuration, the subject can get a sense of x-axis acceleration by virtue of moving the resultant acceleration vector from the y and z axes of the shoulders and spine, respectively, to the back and chest (offset) by rotating the fork. This results in multi-axis accelerations (x, y, z) and may lead to confusion on the part of the centrifuge subject. We have not attempted to produce G_x in the tangential direction of rotation by rotating the fork along with the cab.



Figure 5. Dynamic Environment Simulator (DES) Centrifuge

Gimbals	3 controllable (arm, fork, cab)
Arm (5.8m radius)	56 rpm (20 Gs max); 1 G/sec onset rate
Cab (3m diameter)	180°/sec, 50 rpm max
Fork	180°/sec, 30 rpm max
Weight	170 tons (rotating structure)
Closed-loop control	
Visual system	120° horizontal x 60° vertical
Intersection of roll (cab) and pitch (fork) axes is in the head of the test subject	
Maximum payload	1000kg @ 12 G

Table 5. DES Centrifuge Performance Characteristics

With the seat facing in-board (Figure 6), the subject experiences sustained acceleration in the $\pm x$ and $\pm z$ axes. By rotating the fork in this configuration, the direction of the resultant G vector can be moved from the chest-to-back and spine axes towards the shoulders (offset), which could give a partial G_y acceleration. The in-board facing configuration of the DES is perhaps the most desirable for future supermaneuverable flight simulators since it supports push-pull research (negative-to-positive G_z profiles).

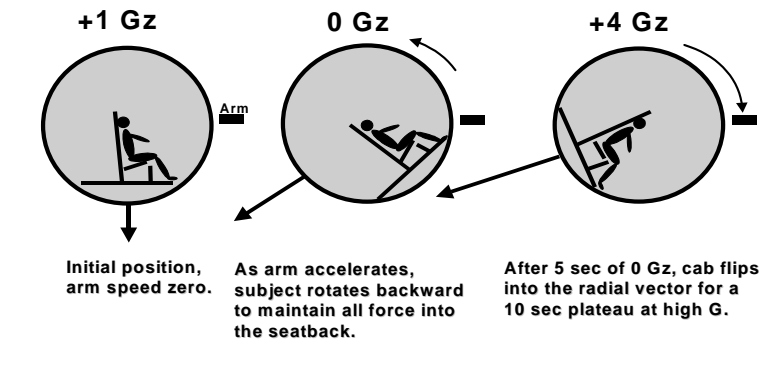

Figure 6. G_x and G_z Exposures in the DES

b) Other Gimballed Centrifuges: Other gimballed human centrifuges include the German Air Force's device at Konigsbruck, Germany, the Singapore Air Force centrifuge, and the Navy's training centrifuge at the LeMoore Naval Air Station (NAS) CA. None of these devices are being used for agile flight simulation research. New centrifuges for Sweden, England, and France will be gimballed and will make multi-axis accelerations possible [1, 8].

Other Simulation Devices

Supermaneuverable flight is also being simulated on or by other devices. These devices included scale model aircraft as well as configurable full size aircraft.

a) Technion University Research: Dr. Ben Gal-Or, Professor of Aeronautics at the Technion University, Israel, has been flying and evaluating 1/7th scale models of high performance aircraft for many years. Dr. Gal-Or and his associates helped define the aerodynamics of high alpha, post-stall flight maneuvering using radio-controlled scale models of the F-16 and F-22. For example, Dr. Gal-Or has evaluated thrust-vectoring and other agile flight parameters on high performance aircraft. Several of his papers discuss thrust-vectoring and high-alpha flight [10-13]. Dr. Gal-Or has been able to define flight control problems on his models and has even collected scaled G_x , G_y , and G_z data in the cockpit of a 1/7th scale F-15 for the Air Force.

b) VISTA: The VISTA (Variable Stability In-Flight Simulator Test Aircraft) aircraft is a modified F-16 aircraft that is an in-flight simulator for flight control. The VISTA is equipped with thrust vectoring and can perform supermaneuvers. A fact sheet is shown with the figures.

What is still needed to simulate supermaneuverability? Table 6 shows a matrix of current simulation devices and their ability to simulate visual and motion cues of supermaneuverable flight. They are the judgment of the author. An overall rating of the device for supermaneuverability simulation is also given (1 is poor, 5 average, 10 best).

Facility	Type Device	# of X,Y,Z Axes Simulated	Max G Onset	Visual Display	Rating
DES (WPAFB)	Gimbaled Centrifuge	Two	20 G (1 G/sec)	120° x 60°	Good-7
DFS (Veda)*	Gimbaled Centrifuge	Two	40 G (13 G/sec)	90° x 30°	Excellent-9
GAF IAM (Konigsbruck, Germany)	Gimbaled Centrifuge	Two	12 G (5 G/sec)	24° x 32°	Good-8
Singapore AF	Gimbaled Centrifuge	Two	15 G (6 G/sec)		Good-7
US Navy (Lemoore NAS)	Gimbaled Centrifuge	Two	15 G (6 G/sec)		Good-7
LAMARS (WPAFB)	5 Degrees of Freedom Flight Simulator	Three	1.6 G/sec	266° x 108°	Good-5
*Decommissioned February 1999					

Table 6. Supermaneuverability Simulator Matrix (Ground-based)

c) **CAFS**: The Combined Acceleration Flight Simulator (CAFS) was a dream of the Air Force Armstrong Laboratory in the early 90s. The program went no further than concept development. The idea behind CAFS was to develop a ground-based flight simulation facility that would allow researchers to study supermaneuverable flight and the continuum between impact forces (occurring in less than .2 sec) and sustained acceleration (existing greater than 1 sec) [4, 5]. Currently, impact and escape (ejection seat) facilities exist (G duration less than .2 sec) as do centrifuges (sustained acceleration duration >1.0 sec). The period from .25 < G duration < 1.0 sec has not been well-documented in terms of biodynamic effects because the research facilities do not exist. The CAFS concept involved a gimbaled cab suspended by electromagnets in a large circular loop with a radius of over 200 ft (Figure 7) [4]. The centrifuge would have a wide FOV visual display system and be capable of combined angular and linear accelerations with man-in-the-loop control. The large radius track centrifuge would reduce the effects of Coriolis, where dizziness accompanies stimulation of the vestibular system as a result of angular accelerations as well as other untoward biodynamic effects.

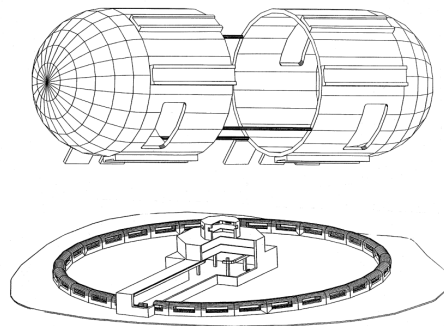

Figure 7. CAFS Gondola and Track (Bottom)

How to Perform Supermaneuvers on a Centrifuge

Several supermaneuvers are described and the technique to simulate them on the DES centrifuge is explained. The DES cab is nested inside the fork (Figure 5). The gimbals are opposite those shown in Figure 4 (view B). The cab and fork can rotate, independently, the full 360°. In the DES, the fork rotates about its axis and the cab rotates about an axis orthogonal to the fork axis. Below are several supermaneuvers and a description of how they are performed in the air and simulated in the DES.

a) **The Cobra**: Perhaps the easiest supermaneuver in a gimbaled centrifuge like the DES is the Cobra. The Cobra is characterized by flight in the longitudinal axis of the aircraft with a small loss of altitude and a pitching up of the aircraft about its pitch axis greater than 90° while maintaining approximately the same altitude and its velocity vector (Figure 8).

Other than being an air show stunt, the Cobra can be used to slow the aircraft abruptly or to gain a lock on an adversary flying above the aircraft. To simulate this maneuver which involves the x and z axes only, the subject is faced inboard on the DES. Since the maneuver typically generates only 4 Gx and some negative Gz, the simulation is accomplished by pitching the cab up 120° and then back down to the normal vector for 1.4 G (12 revolutions per minute). The F-22 should be capable of performing the Cobra.

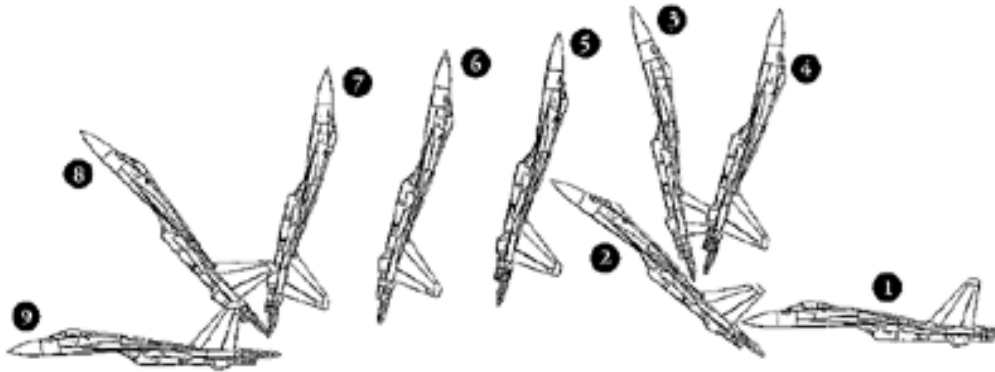

Figure 8. Cobra Maneuver

b) The Kulbit: The Kulbit (which means “circle” in Russian) is a high angle-of-attack (AOA) Cobra, followed by a low airspeed, looplike, vertical rotation (Figure 9). This “somersault” combines rapid deceleration with a full 360° , tight diameter loop. It is an awesome maneuver to observe. From a horizontal attitude, a pilot rapidly pitches the nose up, using the integrated fly-by-wire flight control and Thrust Vectored Control (TVC) system to command high pitch rates (positions 1-5). Altitude gain is minimal and airspeed drops quickly as AOA reaches 90° ; the aircraft is still moving horizontally. With airspeed below 50 kt., the aircraft goes inverted and the nose falls through the horizontal (positions 6-8). As airspeed increases, the pilot pulls through the nose-down vertical position and back to horizontal, accelerating in the same direction as he started the maneuver (positions 9-12). This modified Cobra could force an adversary to overshoot, positioning the Su-37 for a missile [16]. To simulate the Kulbit in the gimballed centrifuge the Cobra simulation (described above) is initiated. The pilot continues to pull the stick aft and the centrifuge cab rotates a full 360° . At the end of the maneuver the pilot is facing inboard, again.

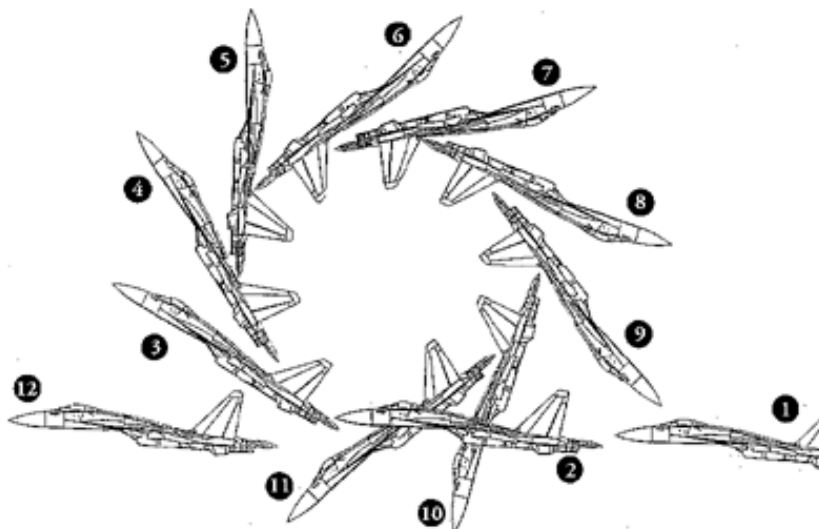

Figure 9. Kulbit Maneuver

c) The Bell: This tail slide of the Bell maneuver (Figure 10) begins as a vertical climb (positions 1-2), but with airspeed rapidly decreasing to about 0 kt. at the top (3). Using TVC, the pilot holds this position for 2-4 seconds, then pitches the aircraft onto its back (4-6), lets the nose fall toward the vertical and rolls out in another plane while accelerating. “This Bell maneuver could be good for a close-in (less than a 5-mi. separation) fight with a stealth

aircraft,” Skip Holm, a former USAF fighter and test pilot, suggested. Holm also tested aircraft for Lockheed and has flown the Su-27. He suggested that if a conventional fighter spotted a stealth aircraft at fairly close range and crossing at a 45° or greater angle, a Bell maneuver could enable a rapid direction or plane change without losing sight of the stealthy adversary [16].

The Bell is simulated by performing the Kulbit maneuver (above), but after being rotated -250° , the pilot “rolls out” (the DES fork rotates) and as the pilot levels off, the cab is inverted and the fork is rotated 180° and the pilot is facing “outboard” of the DES.

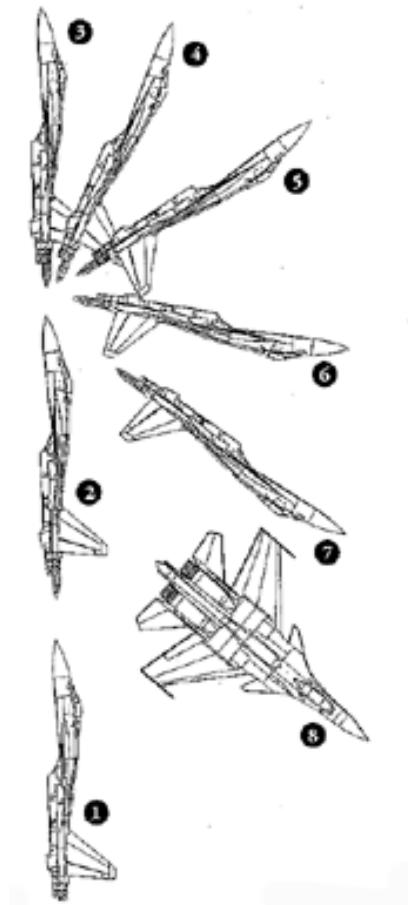

Figure 10. Bell Maneuver

d) The Herbst: The Herbst maneuver is a post-stall maneuver, similar to the Bell, but one which requires lateral thrust vectoring. The aircraft is pitched up into a stall; the thrust is vectored to the left (or right) as the aircraft slows at the top of the stall. The lateral force turns or rotates the aircraft about its yaw axis approximately 180° and the aircraft is then directed back along its original flight path but in the opposite direction. The Herbst will eliminate the need for a long-turning maneuver of a conventional fighter attempting to reverse directions. The Herbst involves x, y, and z exposures so the way it is done on the DES is to face the subject in the tangential direction, pitch the fork up to simulate the stall, and then roll the cab upright to generate a lateral force to the left (for example) and to the right to simulate a Herbst to the right. Both the cab and the fork would then return to neutral positions.

e) The Hook: The hook is a Cobra maneuver, but performed in the horizontal axis.

8.6 REFERENCES

1. Albery, W., Human Centrifuges: The Old and the New, In the Proceedings of the 36th Annual Symposium of the SAFE Association, Phoenix AZ, 14-16 September 1998.
2. Kron, G., Advanced Simulation in Undergraduate Pilot Training: Motion Systems Development, AFHRL-TR-75-59(II), 1975a.
3. Kron, G., Advanced Simulation in Undergraduate Pilot Training: G-Seat Development, AFHRL-TR-75-59(III), 1975b.
4. Raddin, J., Concept Feasibility Analysis for a Large Radius Track-Centrifuge, Brooks AFB TX, USAFSAM-TP-90-3, June 1990.
5. Tedor, J., Ground Simulation of High Agility Flight, In Proceedings of the 1992 SAE Aerospace Atlantic Meeting, Dayton OH, 1992.
6. Young, L., Curry, R., and Albery, W., Motion Sensing Model of the Human for Simulation Planning, In the Proceedings of the 1976 NTEC/Industry Conference, Orlando FL, NAVTRAEQUIPCEN IH-276, 1976.
7. Gum, D., and Albery, W., Time Delay Problems Encountered in Integrating the Advanced Simulator for Undergraduate Pilot Training, J. Aircraft, AIAA, 14, 4, 1977, pp327-332.
8. Albery, W., Current and Future Trends in Human Centrifuge Development, SAFE Journal, 29, 2, September 1999.
9. Schwing, R., The Man-rating Associated with the AFFDL LAMARS System, In the Proceedings of the AIAA Visual and Motion Simulation Conference, Dayton OH, 26-28 April 1976.
10. Gal-Or, B., An Old-New European Debate on Thrust Vectoring, International J. of Turbo and Jet Engines, 14, 4, 1997.
11. Gal-Or, B., Vectored Propulsion, Supermaneuverability and Robot Aircraft, Recent Advances in Military Aviation, 1, 1990, Haifa: The Jet Propulsion Laboratory, pp275.
12. Gal-Or, B., Safe Jet Aircraft, International J. of Turbo and Jet Engines, 11, 1994, pp1-9.
13. Gal-Or, B., Thrust Vectoring: Theory, Laboratory, and Flight Tests, J. of Propulsion and Power, 9, 1, 1993, pp51-8.
14. Kennedy, R., Lillenthal, M., Simulator Sickness: Incidence of Simulator Aftereffects in Navy Flight Trainers, In the Proceedings of the SAFE Association, 1984.
15. Howard, I., The Perception of Posture, Self Motion, and the Visual Vertical, Chapter 18 in Handbook of Perception & Human Performance, Vol II, John Wiley & Son.
16. Scott, W., Su-37 to Display High-AOA Capabilities, www.canopus.spi.imsk.su/~watson/su37/su37display.htm

9. EJECTION SEAT CAPABILITIES TO MEET AGILE AIRCRAFT REQUIREMENTS

Larry Specker
John Plaga

Air Force Research Laboratory
AFRL/HEPA
2800 Q Street, Bldg #824
Wright-Patterson AFB, OH 45433-7947, U.S.A.

Vic Santi

Aeronautical Systems Center
ASC/ENFC
2530 Loop Road West
Wright-Patterson AFB, OH 45433-5797, U.S.A.

9.1 BACKGROUND

Current USAF seats provide safe aircrew escape up to about 425 Knots Equivalent AirSpeed (KEAS). The performance limit of US ejection seats is cited as 600 KEAS, but very few successful ejections have occurred over 500 KEAS. Windblast is a cause of major injuries and fatalities at airspeeds above 425 KEAS. Adverse aircraft altitude, attitude, and roll rates are also known to degrade survival probability.

Advanced, highly-maneuverable aircraft are expected to make increasing demands on initial off-axis conditions with which ejection systems must contend. A notional representation of current aircraft sideslip capabilities is shown in Figure 9.1.

As aircraft become more agile using advanced flight control systems and thrust vectoring features, the area above this curve will become more of a concern. Experience with aircraft such as the F-16 and F-22 that have a relatively large canopy profile and axial length has already highlighted a number of structural concerns. In these aircraft, the lateral moment on the canopy during jettison in sideslip conditions can cause extremely high loads in the aft hinge areas. In a typical design, failures in this area can result in an

unguided canopy jettison and potential for impacts with the pilot. Escape system designs with a canopy-attached seat initiation lanyard must also contend with adverse lanyard pull angles and the possibility of the lanyard itself failing. Further, most of the current ejection seats were not designed or tested to any off-axis requirements. The US Air Force has only recently added off-axis testing capabilities with the introduction of the Multi Axis Sled for Ejections (MASE) in the late 1980's. This asset can be utilized in sled tests for vehicle yaw angles up to 20 degrees.

9.2 CURRENT US ESCAPE SYSTEM CAPABILITY

The primary ejection seat currently in USAF service is the Advanced Concept Ejection Seat (ACES II) designed by the Douglas Aircraft Company (Figure 9.2). Based on pre-1970 technology, the ACES II has been in use since 1978, with over 8000 units installed in fixed-wing tactical and strategic aircraft. The ACES II represents third-generation ejection seat technology. It represents technology that supersedes first generation, or catapult only, as a propulsive force and

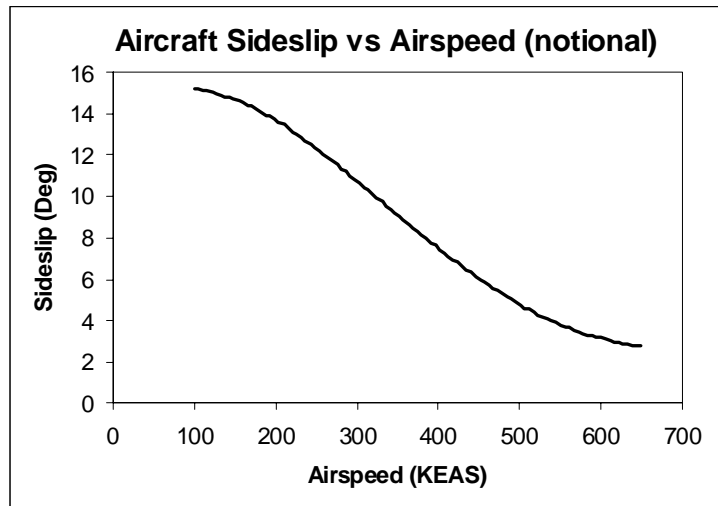

Figure 9.1 Airspeed vs Sideslip Angle for Notional Aircraft

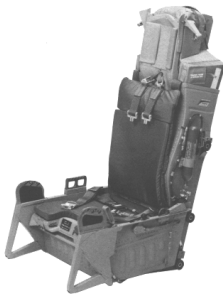

Figure 9.2 ACES II Ejection Seat

second generation, which includes rocket motors to improve low-altitude and low-speed performance. Third-generation seats are characterized by the ability to sense speed and altitude and adjust timing for parachute opening. While the ACES II performance limit is cited as 600 KEAS, few successful ejections (i.e. ejections without major injury or fatality) have occurred over 500 KEAS, and none over 600 KEAS. It is suspected that the actual safe ejection envelope has a much lower top-end speed. The envelopes of ejection seats with poor directional stability and little or no windblast protection are limited by their ability to prevent ejection-related injuries rather than their ability to withstand the aerodynamic and inertial loads imposed during emergency escape. Ejection seat statistics clearly show an increased potential for major injury and fatality at speeds over 425 KEAS.

Navy experience with the Martin-Baker Mk-7 seat is similar. During the Vietnam War, many US aircrew ejected near the upper limits of their aircraft flight envelope and incurred severe or fatal injuries due to high aerodynamic forces. Nevertheless, the US has, in recent years, concentrated in improving aircraft escape in the adverse attitude regime at 100 knots and below. Without newer technology for high-speed stabilization and crew protection, it appears likely that the life saving inadequacy of current US ejection seats will become more evident with future tactical aircraft whose operational envelope could involve sustained flight above 600 KEAS.



Figure 9.3 ACES II Ejection at 30 deg Pitch Angle

Recent USAF ejection seat development and production in the United States have primarily consisted of variants of the ACES II. Development of the ACES II seat was initiated in 1968, and it first entered operational service in 1978. Variants of this seat are now currently installed in the A-10, F-15, F-16, B-1, B-2, F-117, and F-22 aircraft. As aircraft become more agile, it could be expected that initial conditions for ejection attempts could become more demanding. With over 500 ejections to date, the ACES II seat has demonstrated a number of adverse ejections in out-of-control aircraft following events such as mid-air collisions and combat damage. Although the seat has a good record overall, some of these events, along with system testing, have shown areas that may be of concern. Attributes of the ACES II seat that would need to be considered for application in highly agile aircraft include:

Stability: One of the significant advancements of the ACES II seat versus comparable seats of the era was the improvement in ejection stability. Pitch stability is greatly assisted by a seat-bottom vernier rocket coupled with a simple pitch rate gyro (Figure 9.3). The primary stabilization device is a drogue chute system with a dual bridle attachment arrangement. There is no active system on the seat to provide roll stability. Although the ACES II drogue is effective in providing yaw stability, the system cannot be initiated until near tip-off from the ejection guide rails and requires a finite time to deploy and inflate. As a result, once the drogue is fully inflated, it must overcome any initial yaw rates that have developed.

Since there is a high probability of lateral cg offset, coupled with a negative aerodynamic stability, high initial yaw rates can typically be expected. This is further exacerbated by lack of an active limb restraint system on the seat. Initial asymmetric arm flail is also very likely to contribute to development of high initial yaw rates. Figure 9.4 shows typical ACES II lateral forces that result from this yaw rate correction and damping as the drogue chute becomes effective.

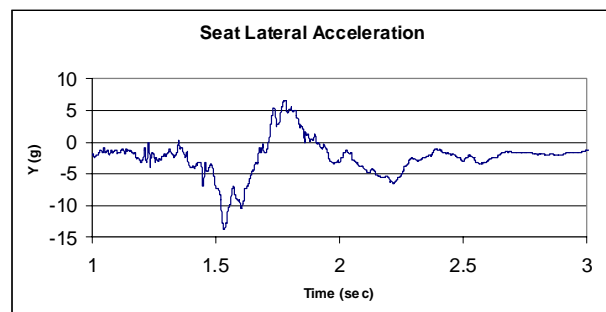

Figure 9.4 Lateral Acceleration

Since lateral accelerations are a frequent cause of failure to meet injury index criteria, improved yaw stability would be an important factor to consider for agile aircraft escape. In recognizing this deficiency, some improvement has been sought through a faster-deployment drogue system now incorporated on the F-22 seat and in development for retrofit on other ACES II variants.

Limb Flail: Assuming an increased probability of unstable ejection conditions from highly agile aircraft, limb flail is another factor that would need to be considered. Although the ACES II seat does incorporate some passive features to prevent leg flail, these have proved ineffective at high speed. These passive features could be expected to be even more ineffective for ejections initiated at unstable conditions. With the exception of the B-1B and F-22 ACES II seats, there is also no active arm restraint system on the seat. The ACES II seat primarily relies on the crewmember to assume a good ejection position and retain a grip on the ejection controls as a means to minimize flail potential. For a highly agile aircraft, initially applied forces and human inertial responses will make it very difficult to maintain a good ejection position. Both test and operational data have shown that an unprepared pilot, who cannot assume and maintain a good ejection position, is much more likely to experience severe flail injury. Figure 9.5 shows a test simulating ejection from an aircraft in a rolling condition. Poor body position, with initial limb flail of the test manikin, is apparent.



Figure 9.5 Dynamic Roll

Restraint System: The ACES II restraint system consists of a lap belt and dual inertial reel shoulder straps. The inertial reel straps converge at a center location on the seat and allow shoulder movement for pilot mobility. The system is effective for axial restraint, but provides limited lateral restraint. Increasing numbers of small pilots, including females, who are now entering flight operations further compound this problem. Figure 9.6 shows the expanded pilot population outside the original design range of the ACES II seat. In some cases the torso harness itself and the available adjustment is a limiting factor. In addition to torso restraint problems, the lack of a negative g restraint has been a source of complaints from a number of pilots, and a negative g strap has been investigated as a potential ACES II improvement. Since agile aircraft could expose pilots to higher levels of negative and lateral g forces, improvements in the ACES II restraint system would need to be a consideration.

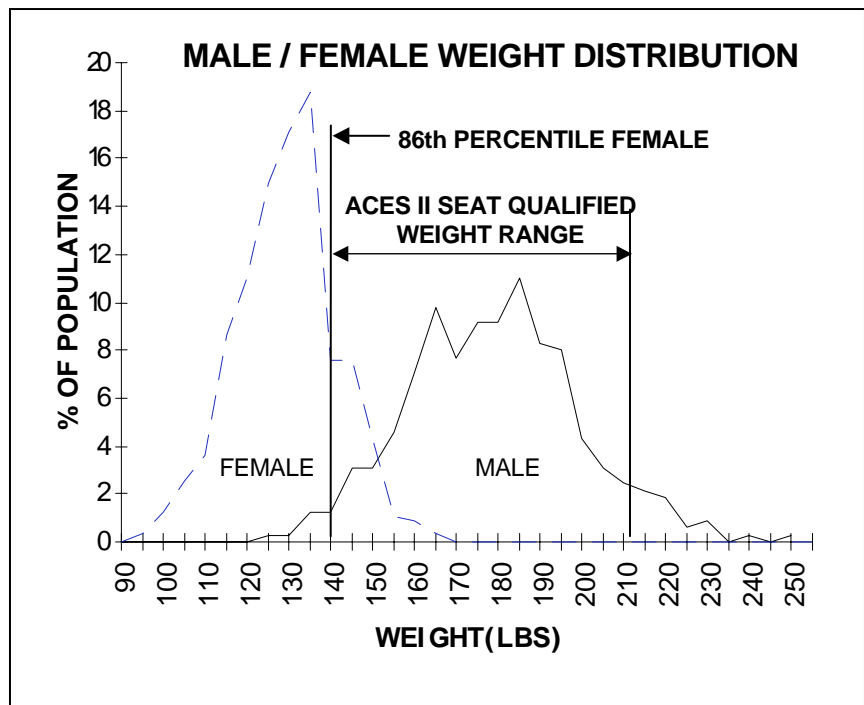

Figure 9.6 Male and Female Weight Distribution

Ejection Acceleration: Another area that may be significant in agile aircraft is the likelihood of ejection from an aircraft experiencing higher positive accelerations. In an Air Force Research Laboratory study of ACES II catapult performance under impressed accelerations, a number of tests were conducted at 3.5 and 7 Gs. These tests indicate that a much higher spinal injury rate can be expected as impressed accelerations increase. Injury probability from a 7 G impressed acceleration was approximately 99%. This performance demonstrated that the ACES II seat is not well-suited to aircraft where high positive G loads might be experienced at ejection initiation.

Adverse Attitude: Very limited data exist for ACES II performance at adverse attitudes. Some modeling has been conducted for recent aircraft with high angle-of-attack capabilities. Several tests have also been conducted with conditions identified in Table 9.1 below. These tests demonstrated relatively poor performance, with data showing higher injury probabilities and reduced recovery altitudes. Figure 9.3 shows the results of a 30° pitch attitude test, with drogue chute inflation adversely affected by the seat attitude and rocket plume effects.

Table 9.1 Initial Conditions for Test

Aircraft Forebody	Speed (KEAS)	Pitch (Degrees)	Roll (Degrees)	Yaw (Degrees)
F-16	475	0°	0°	20°
F-16	303	30°	0°	0°
F-16	436		Dynamic	
F-16	314	30°	0°	20°

9.3 FOREIGN CAPABILITY

At the 1989 Paris Air Show, a Russian-made K-36D seat gained wide public attention when the pilot successfully ejected from a MiG-29 after engine failure at an altitude of 300 ft with the aircraft in an 80 degree pitch-down attitude (Figure 9.7). The airspeed at ejection was approximately 100 knots. Although the parachute deployment occurred when the pilot was only 10 to 20 ft above ground, he survived with little more than bruises on his back, abdomen, and a small cut on his right eyelid.



Figure 9.7 K-36D Ejection at 1989 Paris Air Show

The K-36D ejection seat is standard equipment in the Former Soviet Union high-performance combat aircraft, and is rated for survivable ejections at speeds of 0-755 KEAS

(0-1400 km/hr) and altitudes of zero to 80,000 ft. This is in contrast to US ejection seats which are designed for ejection speeds of 0-600 KEAS (0-1110 km/hr) and altitudes of zero to 50,000 ft.

The K-36D ejection seat was designed by the Zvezda Design Bureau in Tomilino, Russia. The Zvezda ejection seat technology is strong in the integration of ejection seat subsystems such as windblast protection, leg and arm restraints, leg lifters, and a vented helmet which is designed to interface with the seat headrest. The K-36D and flight equipment such as the pressure suit and helmet were designed to be flown together as a single system. Incorporated into the seat are ballistically-deployed telescoping stabilization booms with drogue parachutes. The telescoping booms are mounted near the top of the seat for rapid deployment insuring aerodynamic stability. Other subsystems that have been integrated into the seat design include the windblast deflector, the rocket propulsion system, crew recovery parachutes, restraint tensioning devices, and sequencing systems.

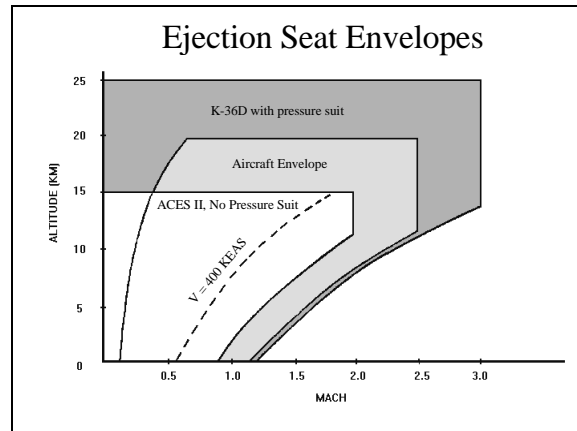

Figure 9.8 K-36D Seat Performance Envelope

Performance Envelope

The Russian K-36D ejection seat is advertised as an advanced ejection seat, providing survival of the crewmember up to Mach 3.0 and altitudes of 80,000 feet (Figure 9.8). The K-36D ejection seat is designed to ensure survival of the crewmember within a wide range of aircraft speeds and altitudes (Figure 9.9). The basic operating limitations of the seat depend on the flight gear used, the aircraft type, and flight conditions at the time of ejection.

General Operation

The ejection is initiated when the crewmember pulls the ejection handles located on the front of the ejection seat bucket. After ejection is initiated, canopy jettison and seat operation are automatic. The K-36D ejection seat has an inter-seat sequencing system that allows one crewmember to eject the other. Crewmember separation from the seat occurs as the shoulder, waist, leg and arm restraint systems are severed by restraint cutters as the parachute headbox is ballistically deployed from the main seat structure. The parachute inflates automatically after seat separation from the crewmember. The survival kit remains attached to the crewmember during descent.



Figure 9.9 K-36D Ejection Seat

K-36D-3.5A Ejection Seat

A newer version of the Russian seat, the K-36D-3.5A, is focused on crew accommodation, cockpit accommodation, and reliability, maintainability and supportability. The ejection seat was designed as a joint program to meet Russian as well as selected US requirements.

The K-36D-3.5A meets many of the technical challenges not met by Western-made ejection seats. All systems on the K-36D-3.5A are designed to work together. The stability subsystems of the ejection seat are an excellent illustration. To provide stability, the seat is equipped with telescoping booms which are stowed on the seat sides during normal aircraft operation. During emergency escape, the booms are deployed and fully functional immediately when the ejection seat enters the windstream. Complementing the boom performance, a windblast deflector is deployed at higher airspeeds to provide windblast protection to the ejecting crewmember. As the windblast deflector sends the airflow around the aircrew and seat combination, it ensures correct airflow conditions for the booms that improve the overall seat performance.

The seat has been demonstrated to work well from adverse initial aircraft attitudes during emergency escape. A positive stabilizing moment is provided, and the newest version of the seat has been equipped with roll rockets to provide trajectory modification during low-altitude ejection or during sequenced ejection with a second ejection seat.

The K-36D-3.5A was also designed to accommodate the full US pilot population, incorporating features such as an adjustable seat back and seat pan. The restraint system provides passive limb capture capability and positive retention. Leg lifters are deployed during emergency escape to pull the legs up and out of the airflow while an aircraft integrated garter is snugged against the lower leg. The leg garters are incorporated within the cockpit leg wells and do not require the crewmember to don the system upon entering the aircraft. The arms are protected by arm paddles that are deployed as the seat moves up the rails. The paddles move outward, followed by a downward rotation and subsequent movement towards the centerline to provide limited capture and snugging retention. A twin-grip ejection handle is located behind a wind-breaking netting attached to the windblast deflector. The aircrew helmet is also designed to provide protection when used with the K-36D family of ejection seats. During emergency escape, the visor of the helmet is automatically lowered, serving to protect the eyes and helping to reduce lift loads on the head. The headrest is contoured to accept the shape of the helmet which provides some retention capability. Both of these features are complemented with the modified airflow over the windblast deflector to provide control of the aerodynamic and inertial forces acting on the crewmember's head during escape.

9.4 ADVANCED US ESCAPE SYSTEM CAPABILITY

Advanced escape technologies have been demonstrated that will provide safe escape throughout the aircraft envelope and at adverse conditions. The joint USAF and Navy Fourth Generation Escape Systems Technology Advanced Demonstration Program was conducted under USAF contract to develop and demonstrate technologies which will enable the expansion of the aircrew escape envelope beyond that of current US escape systems. The areas of the escape envelope in which expansion was demonstrated were for escape at extremely high speed and under low-altitude, adverse attitude conditions. The primary technologies that were developed for demonstration were controllable propulsion, digital flight controls, and advanced life protection.

The goal of the program was to demonstrate a *measurable* advance in crew protection by combining controllable propulsion with advanced life protection concepts to provide safe escape at speeds up to 700 KEAS and at low altitude, adverse attitude conditions. The Fourth Generation Escape Systems Technology Demonstration Program (commonly referred to as the 4th Gen program) was initiated in February 1992 as a two-phase program. Phase I involved the demonstration of two competing controllable propulsion systems. Phase II involved the integration of the selected propulsion system with a digital flight control system, the installation of high-speed life protection devices, and ejection testing of the demonstration seats under a variety of test conditions.

Phase I—Controllable Propulsion

The propulsion system demonstrated was an H-shaped rocket motor with solid propellant in each of the five segments of the housing and with pintle-controlled nozzles at the four ends of the H. Actuators were used to drive the pintles located within the nozzles. Two controllers were mounted with each controller responsible for two of the four actuators. The motor was designed so that it could be installed on an existing ejection seat (ACES II) for the system demonstration phase of the program. The H configuration was selected because this arrangement places the four nozzles at the farthest aft corners of the seat where they can generate large moment arms for attitude control. The ACES II catapult was retained, but the ACES II propulsion rocket and stabilization rocket were not used.

The motor was manufactured by Aerojet and had a thrust profile starting at approximately 5,000 lbs thrust and decreasing to approximately 3,000 lbs. The motor was able to maintain constant pressure over a burn time of approximately one second with thrust tail-off occurring within an additional half second. Each of the pintle nozzles was angled inboard so that modulation of the thrust of each of the four nozzles could be used to generate moments in pitch, roll, and yaw (see Figure 9.10). Modulation of each nozzle was controlled to maintain constant motor pressure and total thrust. The maximum thrust for one nozzle is 2,500 lbs and the minimum thrust for one nozzle was designed to be 150 lbs (later demonstrated to be as low as 0 lbs (closed pintle)).

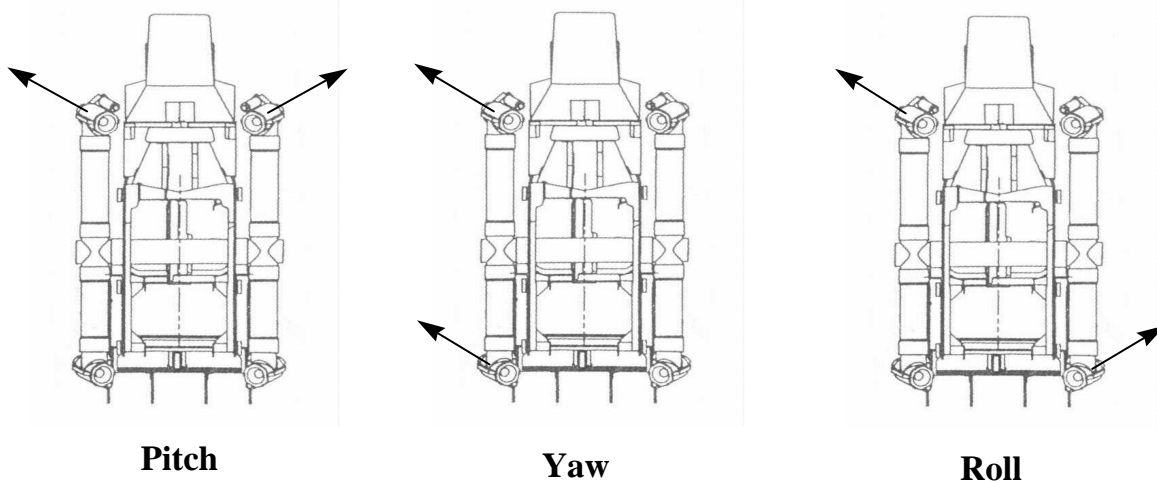

Figure 9.10 Diagram of Pitch, Yaw, and Roll Moments

Phase II—Flight Controls And Life Protection Demonstration

Guidance & Control

Ejection seat stability provides the key that simplifies and enables all life protection devices. Control of seat attitude during flight and at very high speeds was achieved by the flight control system which integrates the propulsion system, inertial measurement unit (IMU), and guidance and control unit (GCU). The GCU for the 4th Gen program was a modified version of the Joint Direct Attack Munition (JDAM) GCU. Modifications consisted of providing additional interfaces and application-specific software algorithms. The top-level block diagram of the control system is shown in Figure 9.11.

The stability margin of the system was designed to accommodate variations from nominal physical conditions, including the following parameters: mass, center of gravity and moments of inertia, aerodynamic forces and moments, center of pressure, aerodynamic damping coefficient, maximum system thrust, maximum thrust per nozzle, propulsion time lag, and propulsion frequency response. The adverse attitude test conditions of 450 KEAS at 20 deg yaw and the highest speed test condition of 700 KEAS were the most demanding on the control system.

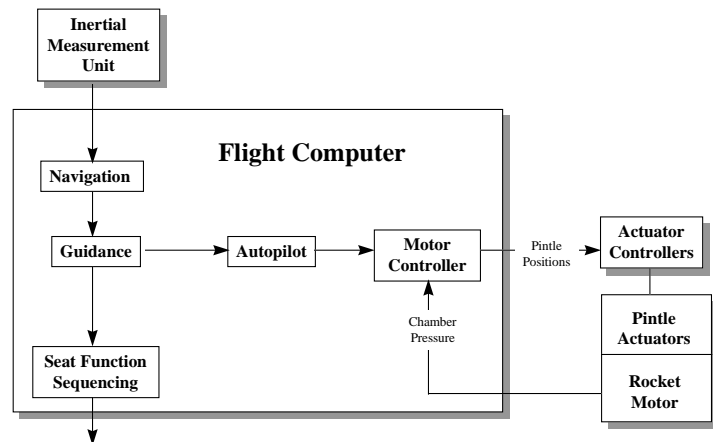

Figure 9.11 Flight Control Block Diagram

Life Protection Devices

The 4th Gen demonstration seat was a modified ACES II. Selecting the ACES II seat as the basic platform enabled demonstration of key technologies without developing a completely new seat structure or redesigning basic functions, such as seat/occupant separation and main parachute deployment. The demonstration seat configuration is shown in Figure 9.12. High-speed protection features included a torso restraint harness, an arm restraint system, a leg protection system, and a head protection system. The seat was modified with anti-foot-rotation panels, extended leg guards, a leg-lifting seat pan, and leg restraints. Arm restraints were used as well as a single-point harness. Head protection was provided by a flow stagnation concept involving a retractable brim. The brim concept (see Figures 9.12 and 9.13) consists of a fence that is positioned above the head to reduce the lift force on the helmet by altering the airflow.

The seat was successfully tested at several adverse initial attitudes including one at 450 KEAS, 20 deg yaw. Under this adverse yaw condition, the seat aligned with the relative wind so that the accelerations and lateral loads remained within human tolerance. Just prior to rocket burn-out, the seat re-oriented itself for alignment with the drogue parachute which eliminated excessive body motions usually associated with misalignment with parachute risers.

In terms of injury tolerance, the high-speed performance (600 and 700 KEAS) of the 4th Gen technology demonstrator was better than any other experimental or operational seat. The controlled propulsion system and avionics were able to provide stability immediately upon separation from the rails, thereby minimizing lateral acceleration and asymmetric loads.

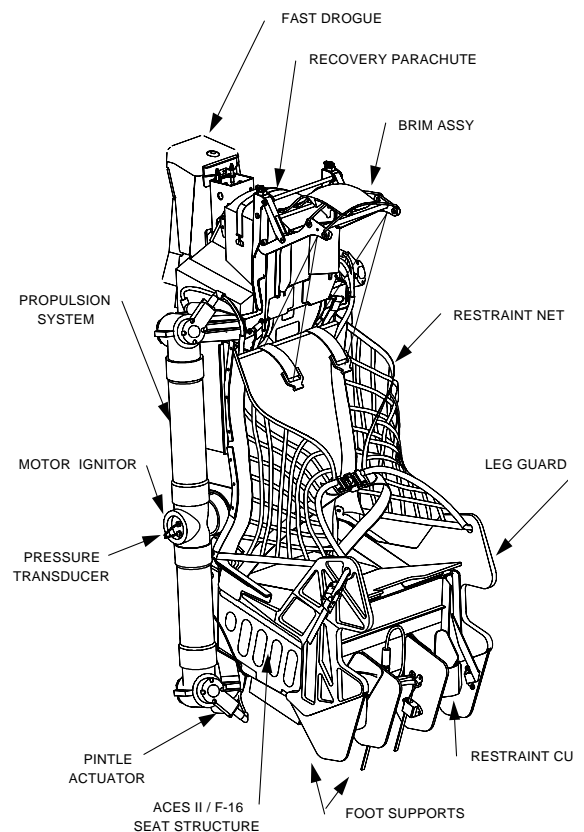

Figure 9.12 Demonstration Seat

Simultaneously, the forward component of thrust minimized the deceleration by countering the initial induced drag.

In all tests, the helmet was retained, which is a substantial improvement over current operational systems. The stability of the seat and effectiveness of the brim are considered as the contributing factors to the level of success attained. The neck axial force during the ejection sequence indicated a peak value just over 400 lbs (300 lbs criterion) when filtered at 100 Hz.

9.5 CONCLUSION

Tests of foreign and advanced ejection seats have demonstrated the technical capability to provide occupant protection during ejections from disabled aircraft with adverse initial attitudes and high ejection airspeeds, which are similar to those conditions encountered during escape from agile aircraft. The K-36 ejection seat has inherent passive high-speed stability, windblast protection, and reduced occupant accelerations at airspeeds beyond those formerly thought to be feasible with US open ejection seat technology. Current versions of the K-36 include trajectory-shaping rocket motors that modify the trajectory when the seat is fired during adverse initial attitudes. The windblast deflector, the vented helmet, the arm retention paddles, and the leg lifters, acting in combination with the restraint systems of the K-36, provided reduced occupant loads throughout the free-flight portion of the escape sequence.

The 4th Gen program successfully demonstrated controllable propulsion integrated with a flight control system and high-speed life protection devices. Significant contributors to the level of success attained in the program included the following: robustness of design of the rocket motor, margin within the design of the flight controls, and application and integration of propulsion and life protection technologies. These accomplishments provided an ejection seat demonstrator capable of stable flight and trajectory-shaping under a range of flight conditions to include low-speed, adverse attitude and ejections at very high speed. The Fourth Generation Escape Systems Technology Demonstration Program demonstrated *unprecedented* performance and established the *benchmark* against which future ejection seat performance will be judged.

Recent ejection seat programs have addressed some of the challenges that agile aircraft pose for advanced ejection seat technologies. Demonstration and foreign comparative test programs have illustrated advanced ejection seat technologies that are available for performance improvements from unstable and disabled aircraft. However, the agile flight environment poses additional threats to ejecting aircrew. These include ejection seat stability and aircrew windblast restraint. Any instability of the aircraft at the time of emergency escape will overburden the marginal stability devices that are provided on the current seat, which will lead to increased limb flail injuries unless advanced windblast restraints are incorporated.

9.6 REFERENCES

“ACES II, Advanced Concept Ejection Seat,” McDonnell Douglas Information Brochure, McDonnell Douglas Aerospace, St Louis, Missouri, 1993.

Hall, Justin, The Vibration Environment of an Ejection: Lessons Learned from the Fourth Generation Escape Systems Advanced Technology Demonstration Program, Paper presented at SAFE Symposium, 1998.

McDonald, A. Blair, Fourth Generation Escape System Technologies Demonstration—Phase II Final Report, Boeing Report Number MDC 97K0154, 27 Jul 1998.

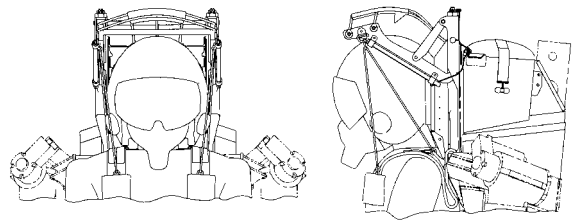

Figure 9.13 Head Protection System



Figure 9.14 Multiple Exposure of Ejection Test from 60 deg Roll

Mertz, H.J., Irwin, A.L., Stanaker, R.L., and Beebe, M.S. "Size, Weight, and Biomechanical Impact Response Requirements for Adult Size Small Female and Large Male Dummies." Proceedings of the International Congress and Exposition., SAE Technical Paper Number 890756, 1989.

"MAINTENANCE MANUAL, K-36DM, Series 2, Ejection Seat," ZAB-9200-0 DM Series 2 PE, Zvezda Design Bureau, Tomilio, Russia, Sep 1985

Moy, H.R., "Advanced Concept Ejection Seat (ACES) Development and Qualification," ASD-TR-73-2, Life Support System Program Office, Wright-Patterson AFB, OH, Jan 1973.

Rabinovitch, B.A., Livshits, A.N., Naumov, V.A., Belovintsev, V.S. and Davidov, R.D., "Test and Evaluation of the K-36D Ejection Seat Analysis and Results," RD & PE Zvezda Design Bureau, Russia, Mar 1994.

Schoen, James, Fourth Generation Escape System Technologies Demonstration—Phase I Final Report, McDonnell-Douglas Report Number MDC 97K7016, Feb 1997.

Severin, G. I., J. W., Rabinovitch, B. A., Specker, L. J., et al, "Foreign Comparative Testing, Test and Evaluation of the K-36D Ejection Seat, Test Reports: Volumes I-IV," RD & PE Zvezda Design Bureau, Tomilio, Russia, 1993.

Specker, L.J., and Plaga, J.P., "The K-36D Ejection Seat Foreign Comparative Testing (FCT) Program," Armstrong Laboratory, AL/CF-TR-1996-0099, May 1996.

Wheeler, Craig M.; Niedzielski, Paul; Barnette, Bill; McDonald, A. Blair; Fourth Generation Escape System Technology Demonstration Pintle Nozzle Controllable Propulsion System, Paper presented at SAFE Symposium, 1998.

This page has been deliberately left blank



Page intentionnellement blanche

10. CONCLUSIONS

T.J. Lyons

*Asian Office of Aerospace Research and Development
7-23-17 Roppongi
Minato-ku, Tokyo 106-0032, Japan

10.1 DEFINITION OF AGILITY

While historically the issue of agile flight was first seen as an issue of airframe agility with a consequent emphasis on acceleration issues, there has been an evolution in the understanding of agility. WG 27 adopted the recommendations from WG 19, that aircraft agility is only one aspect of agility which when combined with weapons agility and systems agility results in "operational agility." Increases in agility of each of these components will result in increased Global Agility which will result in an increased information flow being made available to the pilot. This increased information flow will need to be efficiently utilised in order to maximise operational agility and mission effectiveness.

10.2 THE FUTURE OF AGILE FLIGHT

The issue of agile aircraft is controversial. The controversy over the need for agile aircraft is partly the result of uncertainty over the nature of future air-to-air combat. Will close-in-combat still occur or will air-to-air combat be decided in the beyond visual range arena? Will future missile developments make the offensive and defensive contributions of aircraft agility not essential? The quite different opinions regarding the tactical advantages of agile flight reflect underlying assumptions regarding the nature of any future air war and missile technology. The role of UAVs in the area of air-to-air combat is also debated, especially in light of current limitations in machine vision capabilities.

High AOA flight allows for very low speed manoeuvring. However, there is a trade-off between high agility/high AOA manoeuvres and maintaining energy. Many possible advantages of agile flight have been discussed in the Introduction, including increased manoeuvrability for close-in-combat, increased survivability, improved efficiency/cruise performance, enhanced capability for ground attack, enhanced high altitude operations, capability for extremely short take-off and landings, automatic maneuvers such as automatic guns aiming, adaptation to multiple roles, improved stealth characteristics, and improved mid-air collision avoidance. Proponents of agile flight point out that with the advent of all aspect missile technology, survivability depends on a "point-first" capability if combat occurs within visual range.

Future rapid improvements in both systems (for example, missile approach warnings, missile countermeasures including laser) and weapons agility (missile agility and efficiency) are also expected. While the exact scenarios of future air combat are perhaps unpredictable, all of these technologies will increase both the quantity and the rate of information being presented to the human decision-maker (pilot or otherwise)

10.3 PILOTS' VIEW OF AGILITY

The experienced pilots that we interviewed saw a real operational need for aircraft agility. They consistently rated both high AOA manoeuvres and off-boresight missiles/helmet-mounted display/sight systems as very important capabilities. Most agreed that agile/high AOA flight would not be routinely employed, except as a last ditch manoeuvre when all other options are exhausted. But most believed that having such a capability could prove life-saving in certain scenarios.

Higher G-capability (+Gz) was also thought to be almost as important as high AOA capability. Increased capability to utilize negative G's (-Gz) was not, on the average, highly valued by the pilots interviewed, although there were several test pilots did place value on this capability. Improved thrust was not specifically addressed on our questionnaire, but pilots consistently emphasized the importance of thrust as enabling the use of agile flight/high AOA flight.

10.4 PAST PILOT EXPERIENCE WITH AGILITY

Although the interviewed pilots denied physiologic problems related to acceleration or spatial disorientation, the following needs to be taken into account:

- All sorties to date were with a clear sky. Even under such ideal conditions some loss of situational awareness is evident. For example, one pilot related he was “startled” by his rate of descent when he was descending into a scattered cloud bank at 11,000 feet.
- Pilots not in active control of the aircraft also related some adverse physiologic sensations. For example, pilots related some motion sickness symptoms related to automatic guns aiming.

10.5 PSYCHOLOGICAL CONSTRAINTS

Psychological challenges will include faster information flow and an increase in the possible options available to the agile aircraft pilot (increased task dimensionality). Herbst estimated that events will occur perhaps 2-3 times faster in the agile flight environment. Interestingly, however, on our survey most pilots did not see time pressure per se as a constraint, perhaps because they felt that their responses had to be reflexive in most cases – i.e., no time to think, and thinking considered a waste of time. The combination of increased complexity and increased time constraints may lead to less time for analysis and predispose pilots to consider fewer options and to simplify by using familiar routines. This may lead to more reactive rather than anticipative responses, more superficial evaluation of options, and more opportunistic behavior, increasing the risk of mistakes or mis-adapted choices. Psychophysiological problems of future aviation include increase in rapid shifts between targets and “redundant information saturation”. These factors will lead to an increase in pilot cognitive workload.

Specifically, a better understanding is needed on how humans make decisions under extreme time constraints. An in-depth study of these mechanisms will help develop new training schemes for pilots, innovate systems and interface design, and provide assistance to pilots. Some specific issues in display design include conflict between “symbolic” and “natural” indications; display of flight control parameters on narrow HUD; and changes from “egocentric” to geocentric” frame of reference.

Increasing use of flight management systems, electronic displays, and automatic flight control systems will increase intellectual demands on the pilot while decreasing sensory-motor demands. In some cases automated flight control may actually result in more generalised pilot arousal as an overcompensation.

Existing data suggest a decrease in psychomotor capacities and an overall reduction in information processing capacities during changes in acceleration rates. However, these results were obtained with experimental protocols having little in common with the acceleration profiles encountered in super-maneuverable aircraft. Thus, they must only be considered as a basis on which to conduct more specific research work. The effects of acceleration on psychological capacities are also not well known.

10.6 ANTICIPATED ACCELERATION EXPOSURES

Agility includes the aircraft’s capability to change its velocity vector in multiple directions within a very short time. Future aircraft equipped with thrust vectoring, such as the F-22, will expose pilots to combinations of translational and rotational accelerations not previously experienced in fighter aircraft. Future fighter aircraft will be characterized by high AOA capability (over 60 degrees AOA), and the ability to nose point in all three axes (Gx, Gy, and Gz). While +Gz will probably be less than current aircraft, and of shorter duration, it may be more frequent. Negative Gz exposure will be much more frequent than currently experienced. Zero Gz will be frequently experienced, both as an energy recovery tactic and during maneuver transitions. Gy exposure, now rarely experienced, will become frequent during pointing and escape maneuvers. Gx exposures will increase in magnitude as propulsion systems and air braking systems improve. Because of the unprecedented degree of controllability afforded by thrust vectoring, rapid changes in magnitude and direction involving these accelerations will occur. Furthermore, angular accelerations of over 120 degrees per second will be superimposed on translational accelerations.

10.7 PHYSIOLOGICAL CONSTRAINTS

Only limited research has addressed specifically the issues related to physiological consequences of agile flight and most of what has been published is found in the non-peer reviewed literature. Additionally, most past aeromedical research on the effects of acceleration on humans has focused on the +Gz vector. Relatively little research (about 30 studies, most conducted in World War II timeframe) has been conducted on the effects of -Gz. More recently, a previously unidentified problem, persistent vertigo following Gz (termed the “wobblies”), was described. The direct effects of +/- Gy remain poorly understood. Limited research by Van Patten at the US Air Force indicated the Gy acceleration generates problems of head support and limb mobility. In addition to the limited research examining vectors other than +Gz, until recently almost no research has been conducted on transitions between acceleration vectors. Although the “push-pull effect” from -Gz to +Gz exposures was demonstrated in 1959 and accidents were documented in civil aviation by Mohler in 1972, no further work was undertaken until 1992. Recently, researchers in Canada, Israel, and the United States have implicated the “push-pull” phenomenon in causing military aircraft accidents. Effects of rotational acceleration on performance have also not been studied in depth. Concerns include decreased psychomotor performance and sensory illusion/disorientation.

Potential neuromuscular consequences of flight involving changing accelerations include biomechanical feed-through (BFT); with consequent difficulties in aircraft control. Little work has been done on the effects on psychomotor and cognitive activities at acceleration rates below loss of consciousness thresholds.

Some experts hypothesise an increase in G-LOC accidents. Possible altered states of awareness are likely, too. The long term health consequences of increased agility, especially on the cervical spine, also need to be considered. Consideration should be given to creating a database of agile aircraft pilots in order to facilitate medical surveillance of pilots exposed to this novel environment.

A time series of linear and angular accelerations on current and future aircraft is also needed to guide future research. This research needs to address acceleration vectors other than +Gz, as well as multi-axis exposures, G-transitions, and rotational acceleration. Other priorities include G-suit inflation schedules and evaluation of new protective system designs such as the Libelle anti-G suit. Additionally, the effect of acceleration on cognitive and sensory function needs to be better understood.

10.8 SPATIAL DISORIENTATION (SD)

There are also significant gaps in our knowledge of the vestibular environment in agile aircraft. Translational and rotational accelerations are known to affect spatial orientation and the incidence of vestibular problems may be increased by unconventional acceleration exposures.

Lateral accelerations (Gy) that will be experienced during angular acceleration in voll reversal manoeuvres such as the Herbst manoeuver are known to be problematic. Similar forces are experienced by civilian light aircraft acrobatic pilots, with an important difference - high agility fighter pilots will experience lateral Gy in combination with long radius angular acceleration. The effects of this combination are unknown and will likely be associated with currently unidentified vestibular illusions. While the natural tendency of any pilot might be to reposition the head in the direction of rotation (thus converting lateral angular motion to pitch motion), preoccupation with tactics may not allow orienting compensatory movements. Thus, there could be multiple disorienting stimuli.

Several important illusions in non-agile aircraft were identified only after the loss of aircraft, a notable example being the somatogravic illusion. Vestibular illusions, not yet identified, could lead to pilot misperceptions of flight orientations that are difficult to counter with existing instrument displays. On the other hand, the short duration of manoeuvres predicted by Herbst (less than 5 seconds) may mean that pilots will not be exposed to second order vestibular effects. So some manoeuvres may not, in fact, be as provocative as they might first appear.

Current attitude indicator/HUDs display a two dimensional depiction of the aircraft attitude relative to the horizon. Neither instrument effectively displays the yaw or the velocity vector.

Aircraft crashes attributed to loss of spatial orientation are expected to continue to occur in agile aircraft and probably at an increased rate. Since so little is understood about spatial disorientation, this serious aviation problem needs to be addressed with a multi-disciplinary approach including accident epidemiology, basic research on underlying mechanisms, applied research including the development of validated laboratory models, in-flight validation research, countermeasure research, and SD training research.

In the high-*AOA* environment awareness of aircraft attitude alone is insufficient to prevent controlled flight into terrain (CFIT). Pilots also need awareness of their velocity vector and energy state. So proposed solutions which provide only attitude information such as peripheral displays (Malcolm Horizon) or tactile displays are insufficient. Auto GCAS Systems are technologically mature and will prevent aircraft accidents due to CFIT and accidents due to pilot incapacitation (including G-LOC).

There is an increasing realization that there is a largely unexplored interface between acceleration (e.g., G-LOC) research and spatial orientation (SD) research. Aircraft accidents scenarios reveal spatial disorientation resulting in sudden unintended G exposure and acceleration (G-LOC or near G-LOC) resulting in a disoriented pilot in an otherwise recoverable aircraft. There is also recent evidence of a vestibular influence on cardiovascular responses to acceleration. In agile aircraft, rapid changes in the magnitude and direction of acceleration experienced by pilots will further blur the distinction between acceleration research and spatial orientation research.

10.9 AIRCRAFT DESIGN CONSIDERATIONS

Experienced pilots are quite comfortable with current HOTAS systems. But pilots are unanimous in advocating a simple platform to fly; an integrated flight control system (“carefree manoeuvring”) is essential in future agile aircraft. PIO is a flight control system shortfall that is best prevented at the design stage.

Increased physiological and psychological demands on the pilot combined with faster information flow and increased task dimensionality make a strong argument for some type of electronic crewmember. Basic technologies which will prevent aircraft and pilot losses (including G-CAS, air collision avoidance systems, and auto-recovery systems) have already been demonstrated. UAVs have demonstrated that auto-navigation and auto-land systems are also feasible. But in addition to such safety-enhancing systems, the development of intelligent interfaces including tailored displays/controls, adaptive interfaces (including pilot monitoring systems), and the right degree of automation should be expected to enhance pilot performance – the right information in the right format at the right time. Enhancing the synergy between pilot and vehicle will facilitate the realization of the full potential of agile aircraft.

The seat inclination and its position relative to the aircraft’s center of gravity (CG) will significantly impact the acceleration effects experienced by pilots. The distance of the pilot seat forward of the CG will determine the extent of +/- Gy experienced by the pilot during yaw maneuvers and the amount of +/-Gz during pitch maneuvers. The distance of the pilot’s head above the fuselage datum line will also determine pilot Gy exposure on roll acceleration. For example, on the Eurofighter EAP demonstrator aircraft the pilot’s head was 1.4 meters above the fuselage datum and high roll acceleration rates produced significant lateral acceleration at the pilot’s head, causing both head movement and visual effects. Another possible solution is to design the flight control system to control aircraft movement around the cockpit, rather than around the CG. These parameters and effects should be carefully addressed in the design of future agile aircraft.

Designers should also carefully consider the potential problems introduced by adding a second seat in agile aircraft. Aircrew believe that, depending on the mission, a second crewmember may not be needed; on our “Situational Awareness” Survey, 50% of the pilots believed that a second crewmember would not improve performance. In addition, experience with automated manoeuvres indicates that passive occupants of agile aircraft may suffer from motion sickness.

10.10 PILOT-VEHICLE INTERFACE

The results of the pilot interviews suggest that drastic changes in the crew station hardware are not needed for agile aircraft. Current systems and technologies that are nearing transition are adequate, given they are implemented in a manner designed to support fast assimilation of information and control actuation. The pilots also raised several interface design issues specific for agile aircraft operation:

- 1) Formats for current flight displays are not optimally designed given that agile aircraft have minimal *AOA* constraints and expanded weapon launch envelopes. Current attitude indicators and HUDs present a two dimensional depiction of the aircraft attitude relative to the horizon and neither instrument effectively displays the yaw and velocity vector when flying at high *AOAs*. Simultaneous display of nose position and velocity vector can be problematic. Pilots need a display format that provides a rapidly interpreted indication of the flight path response and yaw.

2) Pilots will need more precise timing and perception of changes in the aircraft's energy state. Energy management is also crucial for weighing candidate manoeuvres or tactics. For instance, pilots will need information as to when to leave the post stall regime to avoid a hazardous attitude. Salient cueing (e.g., tactile) of high AOA/post stall is also needed since it is "easy to command high AOA when you really do not want it."

3) A Helmet Mounted Display/Tracker system is essential to provide needed information through a range of head positions and enable the pilot's helmet position to cue targets and guide sensors. However, extensive research is still needed to determine the optimal symbology format and the reference frame (head, aircraft, earth axes) for symbology elements. The goal is to timely provide needed information with minimal clutter.

4) Formats of head down displays need to maximise the information conveyed while minimising the time required for head down viewing. Use of sensor fusion, pictorial formats, and color coding can help facilitate information retrieval.

5) "Carefree Manoeuvring" or a flight control system that integrates flight and propulsion control is a definite requirement. The stick and throttle can then be used to manoeuvre the aircraft inside the entire flight envelope, automatically taking into account aircraft limitations.

6) Pilots still prefer controlling aircraft functions via HOTAS (hands-on-throttle-and-stick) although alternative or complementary controllers (e.g., voice and gaze-based control) may be worthwhile in the future, especially for "housekeeping" tasks. With possible violent multi-axis motion, the issue of grip/grasp retention also needs to be addressed.

7) Information management, with the increasing number of on-board and off-board sources of data, is a limiting factor. Moreover, pilots will have less time to make critical decisions with the increased tempo of the tactical situation. Decision aids, intelligent interfaces, and automated subsystems can ease workload and help pilots maintain situational awareness. However, there are also problems that can arise with "clumsy" application of these aids. Analyses are needed to determine how these systems should be integrated and identify the optimum role of airborne pilots, ground support personnel, and unmanned tactical aircraft in candidate organisation schemes.

8) Display technology being considered for operational implementation includes tactile displays and 3-D audio displays.

9) Some far term display and control technologies may, after further research and development, provide agile aircraft pilots with *new* capabilities. These include peripheral displays and bio-potential controls. However, these technologies are not viewed as essential for successful agile aircraft missions.

In sum, extensive applications oriented research is still required to optimise the pilot/vehicle interface and make information easier to acquire and control operations quicker to complete. This requires a significant investment for human factors engineering, as well as iterative design and evaluation.

10.11 SELECTION AND TRAINING

Selection (even for non-agile flight) is controversial. Success in pilot training is the outcome metric most often used in previous studies and the selection criteria for agile aircraft pilots is unknown. The value of cognitive factors for selection is not completely understood and validation of motivational factors, stress resistance, intuition, and creativity for selection has yet to be accomplished. Besides the dearth of knowledge of key selection factors, research is also needed on the ideal procedures for conducting the selection process (e.g., the role of unstructured interviews and the role of interviews by experienced pilots).

As with selection, our knowledge of training in both non-agile and agile environments is incomplete. For instance, procedures for conducting combined task training have not been fully evaluated, especially in regards to how well training protocols transfer to the real operational environment. Validation research is needed on "Sensory Training". The utility of devices such as the statoergometer, triplex, and Trampoline needs to be documented. Also problematic is training pilots to function optimally in an extremely time constrained environment and how best to train pilots to make automatic responses.

10.12 SIMULATION

Motion based simulators cannot accurately reproduce the range and onset rates of motion stimuli in agile aircraft. In addition delays or lack of coordination between the visual and motion cues may interfere with training and may cause motion sickness. In visual simulators, simulator sickness is also a problem and may be caused because visual cues are not reinforced with motion cues.

Centrifuges other than gimbaled centrifuges with wide FOV visuals and pilot-in-the-loop capabilities may be obsolete. Even gimbaled centrifuges cannot realistically reproduce agile flight conditions without artifacts. Consideration needs to be given to the increased need for in-flight research. There is, however, potential value in using the flexible capabilities of virtual reality and distributed simulation for assessing tactical concepts and training agile systems operation.

10.13 CREW PROTECTION/EJECTION

The ergonomic design of the pilot-cockpit interface for the agile aircraft poses difficult problems including demands on pilots and life-support systems. Current pilot protection systems will be inadequate in an unconstrained flight envelope and during ejection. Special restraints may be required for the agile aircraft pilot, especially in the lateral, Gy, direction. Seat-occupant displacement due to inadequate -Gz restraint could lead to ejection injuries. Current ejection seats may be inadequate in the initial off-axis ejection conditions which may result from ejection from agile aircraft. Initially high yaw rates and lack of limb restraint systems will increase the potential for flail injuries. Ejection seat performance may be inadequate at adverse attitudes which may be encountered in agile aircraft operations.

The pilot's interface with the cockpit, seat, protective equipment, and personal equipment including HMDs/NVDs also needs to be addressed. The use of HMDs may be limited under Gz, Gy, and rotational accelerations by its weight. The support by an advanced G-protection garment will be needed. For "carefree" handling the advanced G-protection device must work without any delay in time even during high acceleration transitions, must secondly include high altitude protection, and thirdly must ensure pilot comfort.

Agility also includes the aircraft's capability to fly at high altitude and at supersonic speed. Very high altitude capability combined with fast climb rates may result in decompression sickness problems especially if there is not sufficient opportunity for pre-breathing oxygen. However, at levels of 60,000 feet ambient (with an intact cockpit 23,000 feet cabin pressure) catastrophic DCS is unlikely.

10.14 OVERALL CONCLUSION

There are significant human factors issues to be addressed in response to increases in airframe, systems, and weapons agility for future fighter aircraft. These aircraft will be thrust vectored and capable of high AOA maneuvering; G-LOC and spatial disorientation mishaps that continue to occur even in non-agile aircraft, will be an even greater risk as airframe agility increases. Increased systems agility will challenge aircrew cognitive capabilities with increased information flow and task dimensionality and will require improved selection and training strategies. Issues such as automation surprises and new concepts in task sharing will also need to be addressed. There is an historical trend toward decreasing sensory-motor demands and increasing cognitive-intellectual demands on pilots. Research is needed both on cognitive performance and team performance issues and on the interaction between cognitive performance and physiologic stresses. As current simulation of the agile flight environment is inadequate, new simulation capabilities and in flight research will be required. Both basic and applied research will be needed to ensure that the potential benefits of increased agility are realized. Overall operational agility will require an effective pilot-vehicle-interface to ensure mission effectiveness.

APPENDIX A

Glossary

Mr. Patrick LE BLAYE

ONERA

BA-701

13661 Salon-Air

France

A/A	Air to Air
A/C	Aircraft
A/G	Air to Ground
A3A	Aircraft, Armament, Avionics Agility
ACAS	Air Collision Avoidance System
ADS	Aeronautical Design Standard
AFRL	Air Force Research Laboratory
AFTI	Advanced Fighter Technology Integration
AGARD	Advisory Group for Aerospace Research and Development
AGE	Arterial Gas Emboli
AI	Attitude Indicator
AIAA	American Institute of Aeronautics and Astronautics
A-LOC	Almost Loss Of Consciousness
AMAS	Automatic Maneuver and Attack System
AMP	Aerospace Medical Panel
AOA	Angle Of Attack
ASA	Altered States of Awareness
ASAR	Arc Segmented Attitude Reference
AsMA	Aerospace Medical Association
ATAGS	Advanced Technology Anti-G Suit
BFT	Biomechanical Feed-Through
BVR	Beyond Visual Range
C3	Command, Control and Communication
CAFS	Combined Acceleration Flight Simulator
CAPSS	Canadian Automated Pilot Selection System
CBT	Computer Based Training
CG	Center of Gravity
CVT	Control Velocity Test
DCS	Decompression Sickness
DES	Dynamic Environment Simulator
DFS	Dynamic Flight Simulator
DIS	Distributive Interactive Simulation
DOF	Degree Of Freedom
EAP	Experimental Aircraft Programme
ECG	Electrocardiogram

EEG	Electroencephalogram
EF	Eurofighter aircraft
EFM	Enhanced Fighter Maneuverability
EMG	Electromyogram
ESTOL	Extremely Short Take Off and Landing
FEA	Full Envelope Agility
FLIR	Forward Looking Infra Red system
FMP	Flight Mechanics Panel
FMS	Full Mission Simulator
FOV	Field Of View
FVP	Flight Vehicle Integration Panel
G	Load Factor
GAF	German Air Force
GCAS	Ground Collision Avoidance System
G-LOC	G-induced Loss Of Consciousness
GN&C	Guidance, Navigation and Control
GPS	Global Positioning System
Gx, Gy, Gz	Components of the acceleration vector in the body axis
HARV	High Angle of Attack Research Vehicle
HDD	Head-Down Display
HFM	Human Factors and Medicine Panel
HMD	Helmet Mounted Display
HMS	Helmet Mounted Sight
HOTAS	Hands On Throttle And Stick
HUD	Head-Up Display
IAM	Institute of Aviation Medicine
ID	Identification
IFCS	Integrated Flight Control System
IMC	Instrumental Meteorological Conditions
IR	Infra Red
IRST	Infra Red Search and Track
JSF	Joint Strike Fighter
LAMARS	Large Amplitude Multi-mode Aerospace Research Simulator
LSA	Loss of Situational Awareness
M	Mach number
MATV	Multi-Axis Thrust Vectoring
MBB	Messerschmitt-Boelkow-Blohm
MFD	Main Flight Display
MIL-STD	Military Standard
MMT	Multi Mission Trainers
NASA	National Aeronautics and Space Administration
NATO	North Atlantic Treaty Organization
NVD	Night Vision Displays
NVG	Night Vision Goggles
ONERA	Office National d'Etudes et de Recherches Aéropatiales

OODA	Observe, Orient, Decide, Act (Boyd's model)
PBA	Positive pressure Breathing in high Altitude
PBG	Positive pressure Breathing during G-load
PFO	Patent Foramen Ovale
PIO	Pilot Induced Oscillation
PPB	Positive Pressure Breathing
PPE	Push-Pull Effect
PSI	Pounds per Square Inch
PST	Post Stall flight
PVI	Pilot Vehicle Interface
RF	Radio Frequency
RTO	Research and Technology Organization
SA	Situational Awareness
SACM	Simulated Air Combat Maneuvers
SD	Spatial Disorientation
SM	Super Maneuverability
SMA	Sensory Motor Apparatus
SNR	Senior National Representatives
STING	Sustained Tolerance and Increased G (CF-18)
STOL	Short Take Off and Landing
T/W	Thrust to Weight ratio
TG	Technical Group
TV	Thrust Vectoring
TVC	Thrust Vectored Control
TVP	Thrust Vectored Propulsion
UAV	Unmanned Aerial Vehicles
USAF	United States Air Force
VGE	Venous Gas Emboli
VID	Visual Identification
VISTA	Variable Stability
VMC	Visual Meteorological Conditions
VR	Virtual Reality
VTOL	Vertical Take Off and Landing
WG	Working Group
WPAFB	Wright-Patterson Air Force Base
WSA	Weapon System Agility

Aircraft Naming

F-15
 F-16
 F-18
 Harrier
 Rafale
 Eurofighter
 Mirage 2000

JAS 39 Gripen

MiG-29

Su-27

Su-35

Su-37

X-31

YF-22

APPENDIX B

High-Speed Flight as a System of Medical-Psychological Support of Domination in the Air

V. Ponomarenko

Office 12A

Petrovsko-Razumovskaya Alleya, A-83

Moscow 125083

Russia

I am grateful to general Alexis, to colonel J.Linder for the opportunity to take part in the AGARD Congress of persons having identical ideas but different ways of thinking. The debatable character of the Congress makes it possible to speak openly of our experience in apprehending man's adapting to the environment unusual to him. It is pilot's activity under unnatural environmental conditions which serves as an impetus for understanding the sources of man's essential strength, regularities of the ultimate sense of a pilot's needs in mastering the universe. Is this a source of spiritual strength?

Here is a question for airspace medicine.

Airspace medicine, as its name implies, deals with what takes place far beyond the horizon, as its object is not only the functioning of an organism under extreme biophysical conditions but the subject as "a sky inhabitant" as well. A pilot as a "sky inhabitant" exists in a different world of values. In particular, he perceives a high-speed flight, above all, as an instrument for achieving the main result, namely, superiority in dual situations. Speed is a maneuver, tactics which is transformed by intellect into a successful achievement of the final result. The speed of a flight is always experienced as passion. These seemingly irrelevant speculations are directly related to the safety of a high-speed flight. The point is that in a maneuvering air battle a pilot is not so much afraid of losing consciousness, as his prestige, his professional "ego". It is this purposefulness and not fear that draws him to a zone of a realized extended risk.

In 1953 test-pilot Charles Yeager on X-1 aircraft, ignoring implicit signs of threat, achieved the speed of 2.500 km/hr. At this speed the pilot lost control of the plane, and the plane was falling in disorder to the altitude of 9 km. The overload reached 14 G. But the pilot did not lose consciousness, regained control of the plane and landed safely. I guess that the ardent wish to know the unknown played not the least role in the safe outcome of the flight.

In 1955 test-pilot Frank Everest on X-2 rocket-engined aircraft reached the speed of 3000 km/hr. His thoughts and feelings were far from assessing his organism. I am citing: "I felt as a pioneer like Columbus, and experienced a mixed feeling of fear and pride. I was in some remote world located above the Earth and people. I was alone in time and space, far from everything living. I thought I had been useful to Mankind, made somewhat closer the time when Man can make a flight to outer space".

As we can see, a pilot is a different person, capable of transforming individuality into a common social interest of altruistic character and capable of receiving the energy of information-energy fields of the universe. It is a secret which has not been revealed yet.

My personal experience in studying man in test flights, in emergency situations, in studying the moral and spiritual aspect of a pilot's professionalism has led to the conclusion that a person flying gives rise to intellectual-spiritual incentives to changing civilizations, to perceiving Truth given to us in knowledge, spirit and faith.

Airspace physicians, due to their world outlook and open-heartedness, understand human life better and more deeply, orient science to ensuring life safety for a pilot of any country. Let me confirm the above stated by the facts which have gone down in history.

In the late 70-ies US specialists faces the problems of high-maneuvering flights where not only pilot's health but their death as well braked the battle possibilities of aviation. And despite the cold political climate of the opposing social systems, the results of medical research relating to crucial problems of high-speed and low-ceiling flights were openly published in some of US and European journals. Physiological, psychophysiological studies of Man's being ready for such flights, the principles of technical protection aids construction, methods of training, were shared by airspace physicians the world over. The work of airspace physicians from airbases of Brooks, Wright-Patterson,

Pensacola (R.R.Burton, W.B.Albery, J.E.Whinnery, et all.), the works by scientists from Scandinavian countries, England, France, Canada, China influenced productively Russian scientific school as well.

It goes without saying that we had experience of our own in ensuring high-speed flights. In 1959 all the conditions were created for a safe flight on a turbojet when pilot G.K.Mosolov developed speed of 2.504 km/hr. On early supersonic plane MiG-19 in early 60-ies pilots successfully performed battle maneuvers with peak overload of 7 to 9 G_z . Their safety was provided by Russian scientists D.Ivanov, V.Babushkin, M.Vacar, I.Chernyakov and others.

At the same time as one of the medical supervisors in setting up a system of military scientific provision and mastering high-maneuvering aircraft of the fourth generation in the Soviet Union, I can say definitely that the scientific experience of foreign colleagues was taken into consideration in establishing our own system of ensuring high-speed maneuvering flights. This system provided the conditions under which we covered the way of mastering such planes for a period of 1982-1992 practically without a single air crash by loss of consciousness.

We paid the credit by informing US and European researchers of the results of the unique study of Man in long-term outer space flights. Hereby I would like to stress the high level of aerospace physician's responsibility for the future life of Man on the Earth and in the process of mastering flights to other planets.

Based on the above mentioned, I consider it necessary to inform you of our scientists' experience, methodology, the results of research in the field of medical-psychological problems of high-speed flights. By the way, most of the Ph.D. degree papers dealt with this particular problem. I hope all of you know the names of such Russian scientists as P.Isakov, G.Stupakov, S.Gozulov, P.Vasilyev, G.Glod, I.Chernyakov, P.Suvorov, A.Kotovskaya, M.Khomenko, R.Vartbaronov, A.Barer and others.

Some words on the methodology of research. Russian scientific school of aerospace medicine is based on the following principles:

the principle of systematic approach, i.e. interaction of all elements of the "pilot-aircraft-environment" system, taking into consideration the achieving of a social purpose result;

the principle of activity, i.e. providing such conditions and means for activity where the crew members' optimum activities could be achieved. It means that scientific research is aimed not only at the organism survival, health protection, not only at organism medical protection.

The main goal for us is to ensure a fighting efficiency due to professional health, e.i. due to the level of psychophysiological reserves needed for actions reliability under any environmental conditions and at any level of psychological complexity of flight assignment.

In other words, there is a basic level, i.e. a study of biologic-psychological regularities in the functioning of organs and systems in the interest of developing technical protection aids and psychophysiological training. And there is a top level, i.e. research of a professional's reliability and work capacity, his activity as a subject, the laws of his consciousness, self-consciousness as the reserves of Spirit and passion.

Thus the essence of our research methodology is: Man in flight is a bearer of consciousness achieving the final result.

For aerospace medicine, a pilot is an object for studying for the purpose of obtaining data for protection of professional health, development of aerospace equipment, setting up of psychophysiological training in mastering said equipment. That is why such scientific subjects as labor psychology, ergonomics, engineering psychology, aviation systematic engineering are incorporated in aerospace medicine. Without using the knowledge of Man provided by these sciences it is difficult to challenge the technocrat principles of aircraft designing. The analysis of flight crew members' health in Russia and in other countries shows that a pilot's poor health, and sometimes even his life is the payment for ergonomic defects of aircraft, technical inadequacy of protection means, insufficient psychophysiological organization of labor. You will agree that aircraft is designed to meet some mission requirements first and only then the person to carry out the mission is thought about. And at the end of the 10th century man is made "to fit" the plane. This audacious conclusion can be illustrated by the experience of mastering a high-speed flight at extremely low altitudes.

High speeds at low altitudes made the problem of space orientation in a visual flight priority No. 1. At speed over 800 km/hr at altitudes below 80 m a pilot is not able to determine correctly the speed, direction, recognize a small-

size object, to determine the distance to this object, the size and essential distinctive features in choosing a battle maneuver (P.Isakov, V.Ponomarenko, A.Vorona, O.Baluyev and others, 1967).

Psychophysicists stated the phenomenon of "consciousness divarication" between visual and instrument data accompanied by tension of neurophysiological mechanisms, visual and instrument orientation. As a result there appeared the states of navigation disorientation, psychic tension, illusory perception of the horizon and underlying surface.

This was promoted by: small angles of observation, for these flights a low quality of lamp glazing, poor indication of flight parameters, lack of sign-variable overloads damping means. As a result, initially the probability for achieving the required efficiency did not exceed 0.5-0.6. The psychophysiological training for recognizing objects, the methods of developing capabilities to overcome the "consciousness divarication" developed by us afterwards, creation of altitude stabilizers, automatic safety machines, damping devices, new types of inaction, new shapes of lamp, sound signaling of maintaining altitude at battle heading, suit ventilation system and some other innovations enabled a pilot to carry out his mission with a probability of 0.6-0.9.

The psychophysiological adaptation of an aircraft to a pilot's abilities at speeds lower than 1000 km/hr was reached at a price too high - reduction of device and control surfaces are concerned. Organic defects of control using electronic indication were discovered due to its lack of inertia against the background of large overloads.

The problem of fields of vision, coordination of governing movements, spacegeometrical arrangement of visual-motor fields, the problem of color encoding, location of pilots seats, control surface, inclination of instrument panels posed to scientists and engineers a problem of developing new ways for their solution.

A special layer of research dealt with creation and justification of antioverload suits operation mode, automatic pressure machine, oxygen systems, seats inclination choice, profiles of centrifuge exercises, development of forecasting criteria to facilitate medical flight expert examination and some other problems of no less importance. Of course, the loss of consciousness problem and remote consequences of influence of overloads high levels and intensity on man's health.

Big orientation support for the data on classification and periodization of loss of consciousness, systematization of clinical signs characterizing different levels of consciousness disorder, the role of subconsciousness in the activity of the transition process to the beginning of governing activity was provided by the data obtained in the laboratory (Whinnery G.E., 1989, 1991).

Of great value for us were scientific reviews by R.R.Burton (1974), data by M.Caines, R.Landry (1984, 1985) regarding the number of pilots, students who experiences loss of consciousness (over 20 per sent) due to inability or misuse of respiratory and muscle maneuvers (B.McNaughton, R.Gillinghom, 1983). The data obtained on a centrifuge by W.B.Albery, Tr.A.Gordon, J.R.Cooper, 1987) which have determined quantitatively the time of relative and absolute incapability during the loss of consciousness depending on the value and overload increase rate and some other, no less important, protection mechanisms of organism and higher nervous activity.

In the process of developing the justification of the physiological fundamentals of technical and psychophysiological protection means our scientists faces the same facts as those stated by G.T.White and L.M.Morin (1988).

A radical change in strategy of respiration and muscle tension in the process of high-maneuvering flight, especially in using respiration in the conditions of excessive pressure, was implied. Our cooperation with firms developing protection equipment and oxygen systems resulted in creating original protection systems, new profiles of centrifuge trainings, on-ground simulators predicting overloads tolerance (statoergometer), mastering by practice the method of physical training on simulators developed for the purpose, methods of maintaining the habits of control over protection maneuvers in the conditions of overloads on specialized sport planes (R.Vartbaronov, M.Khomenko, S.Migachev, R.Bondarenko, L.Plikhotniuk, 1978, 1980).

The final result: using all protection means and ways made it possible to increase by 3-4 G_z overloads tolerance as compared to the initial level, without deterioration of professional health.

I am not going to dwell upon the contents of these papers, as they were published and presented more than once at congresses similar to this one by our leading scientists in this field Prof. G.P.Stupakov, M.N.Khomenko, A.S.Barer and others.

I will speak briefly only on two points which are not known enough to many airspace physicians.

I mean the methods of training those starting to fly high-maneuvering planes. In studying a pilot's activity in battle conditions it was found, that a pilot absorbed in sighting task decreases control over muscle tension, breast-type respiration, forced exhale. In the event of realized fulfillment of respiratory and muscle maneuvers he decreases his attention to errors in sighting. By a special technique in the process of pilot's activity, with the aid of light marking out, the importance of this or that flight parameter on the sighting indicator, conditioned reaction to timelines of maneuver L-1 or M-1 was consolidated. Any deviation of the flight parameter from the assigned value reflexively increased the required anti-overload maneuver, especially in the conditions of a narrower peripheral vision and/or starting disorientation.

The quantitative dependencies obtained were transformed into programmed control over light-technical marking out of deviating parameters which stimulates timely switching on the required muscle protection.

As a result it was possible to increase by 5 to 10 seconds a period of high efficiency of piloting with overloads of 8-9 unites (V.Ponomarenko, A.Oboznov, D.Arkhangel'sky, V.Vasilyets, 1982). Later these results we used in developing an on-board automated system of maintaining consciousness in highly maneuverable flight (R.Vartbaronov, A.Varasanov, V.Ponomarenko, 1982). At present the system is undergoing a cycle of final tests.

The principle of this system operation is creating conditions for highly efficient work, loss of consciousness being insured. In other words, the principle of safety is aimed not at excluding Man from the control circuit, but at creating safety conditions where extreme physiological tension is involved.

The second direction. To help design working places, indication and control system, a full-scale simulating stand completely simulating flight missions of MiG29 was developed under my supervision (V.Smorchkov, Gu.Tsigin, V.Aivazyan, M.Silvestrov). I can say that for the last 30 years airspace physicians have managed to increase innovation rate of our proposals from 15-20 per cent to 60-70 per cent in the field directly relating to the reliability and efficiency of using aircraft by a pilot.

More over, by using this compax all ergonomic programs of flight tests, equipment and battle sights were mastered by practice, outstripping programs of training, with psychophysiology taken into consideration, were developed.

The final result: it was possible, based on the results of the research, to introduce over 200 changes in the design, mathematical programs, means of control, the quantitative and qualitative characteristics of a decrease in psychophysiological abilities of man in the conditions of high growth-rate overloads taken into account (N.Zavalova, V.Lapa, A.Razumov, I.Nikitin, V.Polyakov, Gu.Kukushking and others, 1978, 1980).

The third direction was concerned with psychophysiological training of airspace physicians and pilots directly in battle subdivisions. These were seminars, lectures, training films, retraining, centrifuge trainings, trainings in the air, special medical control over the state of health and psychological selection and selection of contingent for training and retraining.

Mastering by practice and introducing rates of flight load, kinds of professional rehabilitation, specialized kinds of unaerobic and aerobic physical training, operative voices analysis of causes for loss of health as well as flight accidents.

Such is the system of medical-psychological support of health, work capacity, efficiency of tactic aviation pilots in a high-speed flight (G.Stupakov, M.Khomenko, R.Vartbaronov, S.Migachev, R.Bondarenko and others, 1978, 1985). These are our competitive assets.

In conclusion let me spell our some partial statements regarding the problem under consideration-pilot' health and life protection.

This is my personal viewpoint because it is not completely in conformity with the official stand. My opinion is justified by my thirty-year experience in medical-psychological study of pilots personality and organism, my participation in developing a system of ergonomic support of the third and fourth generation aircraft; experience in direct participation in flight tests, my knowledge in pilot's working and retired life.

In this case I will arrange my conclusions according to the results of military-scientific support for development and operation of 1. First of all, one should state a striking discrepancy between the data obtained by scientists of all countries and the extent of their introduction in the design of aircraft, into technical protection means, into psychophysiological training, arrangement of training, into professional-psychological selection, medical-flight expert examination.

I believe that all those present realize this situation, to a greater or lesser extent. The initial reason is an excessive corporativeness of aerospace medicine as a science, which has taken the responsibility for health safety and national security as a whole. This resulted in weakening control at the level of state policy level of financing, efficiency and reliability of human factor in operating military equipment. This led to the situation where by the time high-maneuver aircraft were put into operation in the Air Force the following things were not developed adequately:

- manufacturing composite materials for high-altitude-overload equipment, including oxygen track;
- software for adjusting automatic pressure machines for oxygen supply and chamber pressurization based on the principle of outstripping and control over maneuver overloads;
- dynamic control over inclination of catapult seat back;
- serial manufacture of centrifuges-simulators;
- serial means of control and warning of a loss of consciousness and automatics transition to a horizontal flight.

These facts, in a sense, are of universal character.

2. Lack of distinctly formulated orientation of fundamental research to innovation result, inertia of administrative branch of medical science with respect to "long-range" results, rigidity of military medicine to change in thinking stereotype, inefficiency of clinic specialists in long-term results of future pilots' activity led to:

- an increase in the coefficient of correlation between the spread of diagnoses and the length of work from 0.75 to 0.87;
- an earlier (3-4 years) exposures to diseases and a shorter professional life expectancy (34-36 years);
- an increase in probability of giving up the profession due to health factors because of a longer recovery period of pilots who have suffered diseases of psychosomatic profile, of metabolism genesis, of malfunctioning of vegetative regulation, of immune and metabolic pathogenesis (medical disqualification increased by 5-7 percent);
- a higher rate of decrease in reliability and increase in probability of flight accidents directly connected with professional health;
- an increase in probability of piloting errors per 1.000 hours for maneuvering flight by 15-20 percent as compared to non-maneuver modes;
- loss of motivation in pilot's job with an element of health aggravation discovered by medical expert examination.

It is a common knowledge now that at the initial stage of mastering new aircraft more than 30 percent of pilots wearing standard protective equipment in experiencing overloads of 8-9 units were capable of flying safely for no longer than 5-7 seconds which resulted in a substantial reduction of professional staff having long life and flight experience.

It took four years to put into practice the results of the scientific research at the expense of a remorary decrease in tactic-technical possibilities of aircraft, i.e. decrease in the level of national security and social protection of pilots when they are forced to give up their profession due to objective reasons.

3. A high level of introducing the results of scientific research of military science is achieved when the following conditions are met:

- state financing of fundamental research in development of means for increasing man's psychophysiological reserves in flight in advance;
- control and participation of the Air Force scientists in developing and testing aircraft;
- joint participation of aerospace medicine and industry in developing ergonomic conditions of work, life insurance and survival means;
- using the test-flight data for training pilots and medical staff;
- timely development of physiological labor instrumental methods of assessing a decreasing professional health;
- constructing a system of restoring man's health based on the principle of long term consequences of a high-speed flight.

4. In the XXIst century the health of pilots flying high-flight performance planes with a valuable velocity vector will be subject to multi-profile effects of maneuvering overloads. In addition to a hydrostatic component there will exist a factor of tissues and vessels deformation, a psychological factor of disorientation in space, orthostatic instability. I guess the time has come to do a deeper research consequences with participation of retired specialists and analysis of diseases which led to death of pilots of high-maneuvering aircraft.

Strange as it might seem, but the means of protection developed by us not only protect health but also provide operational capability within the framework of professional detriment, the latter having been extended by us. "Shagreen leather" phenomenon makes us think of drawing up a declaration on a permissible level of subjecting man to exposure ruining his health and reducing his professional life expectancy.

I believe that in XXIst century the main objective of aerospace medicine will be changing of orientation from nosological principles of health protection to the principle of health of a healthy human being carried out by state strategy of health protection and reproduction of a healthy nation. We, scientists, won the right to select pilots and astronauts on the principle of their health. What we need to do is to provide a pilot with a right to preserve health until he retires.

We are capable to solve this moral problem.
Thank you very much.

1. Vasilyev P.V., Kotovskaya A.R. Prolonged Linear and Radial Accelerations // Foundations of Space Biology and Medicine / Edited by M.Calvin and O.G.Gazenko. - Moscow: Nauka, 1975. - Vol. II, book 1. - P. 177-213.
2. Vasilyev P.V., Kotovskaya A.R. Prolonged Accelerations (Overloads) // Kosmicheskaya Biologiya I Aviakosmicheskaya Meditsina. - 1966. - Vol. 1 - P. 105-107.
3. Kotovskaya A.R. Physiological Effects of Altered Gravitation. Gravity and Organism: Problemy Kosmicheskoi Biologii / Edited by N.P.Dubinin. - 1976. Vol. 33. - P. 115-146.
4. Babushkin V.I. Effect on Man of Extremely Prolonged Radial Accelerations // Voenno-Meditsinskiy Zhurnal. - 1959. - Vol. 8. - P. 50-54.
5. Arkhangel'skiy D.Yu., Plakhotn'uk L.S. Hemodynamic Indicators During Continually Increasing Overloads // Kosmicheskaya Biologiya I Aviakosmicheskaya Meditsina. - 1983. - Vol. 17, No 1. - P. 71-74.
6. Barer A.S. Problems of Acceleration in Space Physiology // Kosmicheskaya Biologiya I Aviakosmicheskaya Meditsina. - 1967. - Vol. 1, No 1. - P. 57-64.
7. Vasilyev P.K., Glod G.D. Flight Acceleration: A Handbook of Aviation Medicine / Edited by N.M.Rudniy, P.V.Vasilyev, S.A.Gozulov. - Moscow: Nauka, 1986. - P. 75-100.
8. Suvorov P.V. Physiological Studies on a Centrifuge in the Practice of Flight Medical Examinations. Doctoral Dissertation. - Moscow, 1969. - 593 p.
9. Stupakov G.P., Vartbaronov R.A., Khomenko M.N. Effects of Chronic Exposure of High-Sustained +G_z-Accelerations on Pulmonary Function // Russian Federation Air Force Institute of Aerospace Medicine. - Moscow, 1993. - 11 P.
10. Vartbaronov R.A., Glod G.D., Uglova N.N. Adaptive and Cumulative Effects in Dogs Exposed to Regulatory Applied +G_z-Acceleration // Kosmicheskaya Biologiya I Aviakosmicheskaya Meditsina. - 1987. - No 2. - P. 37-40.
11. Kotovskaya A.R., Vartbaronov R.A., Khrolenko V.M. Human Tolerance of +G_z-Acceleration during Body Heating // Kosmicheskaya Biologiya I Aviakosmicheskaya Meditsina. - 1975. - Vol 9, No 5. - P. 41-45.
12. Barer A.S., Golov G.A., Zubavin V.B., Tikhomirov Ye.D. Human Tolerance to Accelerations at Reduced Barometric Pressure // Kosmicheskaya Biologiya I Aviakosmicheskaya Meditsina. - 1968. - Vol. 2, No 6. - P. 71-76.
13. Ponomarenko V.A., Oboznov A.A., Arkhangel'skiy D.Yu. On Mental Regulation of the State of the Body during Sustained Longitudinal Acceleration // Kosmicheskaya Biologiya I Aviakosmicheskaya Meditsina. - 1987. - Vol. 21, No 2. - P. 24-27.
14. Vartbaronov R.A., Glod G.D., Uglova N.N., Rolik I.S. Hypovolemic Reactions of Man and Animals to +G_z Overloads of Increasing Intensity // Kosmicheskaya Biologiya I Aviakosmicheskaya Meditsina. - 1987. - Vol. 21, No 3. - P. 35-39.
15. Vartbaronov R.A., Ivanov Ye.A., Kotovskaya A.R., Anisimov G.V. Visual Fitness during Acceleration and Increased Temperature // Characteristics of Cosmonaut Performance in Flight. - Moscow: Mashinostroyeniye, 1976. - P. 145-147.
16. Babushkin V.K., Usachev V.V. Human Fitness for Work during Radial Acceleration while Breathing Oxygen at Excess Pressure // Aviation Sciences. - Moscow, 1974. - P. 36-38.
17. Vartbaronov R.A., Kotovskaya A.R., Nikolskiy L.N. Information Content of Pulsed Blood Engorgement of the Ear Lobe to Evaluate Human Resistance to +G_z Overload // Kosmicheskaya Biologiya I Aviakosmicheskaya Meditsina. - 1975. - Vol. 9, No 1, - P. 59-66.

18. Barer A.S., Yeliseyev A.S., Panfilov V.Ye., Rodin S.A. The Human Operator Exposed to Accelerations // *Kosmicheskaya Biologiya i Aviakosmicheskaya Meditsina*. - 1968. - Vol. 2, No 1. - P. 54-58.
19. Stupakov G.P. Problems of Flight Safety and Efficiency of Aviation Specialists Activities // *Meditsina Truda i Promyshlennaya Ecologia*. - 1995. No 5. - P. 2-7.
20. Palets B.L., Tikhonov M.A., Popov A.A., Arkhangel'sky D.Yu., Palets L.D., Bondarenko R.A. Theoretical Analysis of the Efficacy of Anti-G Suits during Exposure of Continually Increasing Acceleration // *Kosmicheskaya Biologiya i Aviakosmicheskaya Meditsina*. 1987. - Vol. 21, No 2. - P. 27-34.
21. Asyamolov B.F., Voronin L.I., Panchenko V.S., Ulyatovsky N.V., Bondarenko R.A. et al. Study of Acceleration Tolerance and Work Capacity of Operators after 7-days Anti-Orthostatic Hypokinesia // *Kosmicheskaya Biologiya i Aviakosmicheskaya Meditsina*. -1988. - Vol. 22, No 2. - P. 37-40.
22. Vasilyev P.V., Gozulov S.A. The Problem of Accelerations in Aviation Medicine // *Kosmicheskaya Biologiya i Aviakosmicheskaya Meditsina*. - 1982. Vol. 16, No 3. - P. 4-8.
23. Chernyakov I.N. Effectiveness of Oxygen Equipment as Part of a Life Support System for Stratospheric Flights // *Kosmicheskaya Biologiya i Aviakosmicheskaya Meditsina*. - 1989. - Vol. 23, No 1. - P. 11-16.
24. Suvorov P.V., Doroshev V.G., Ivanchikov A.P., Sidorova K.A. Hemodynamic Types in the Flying Personnel: Their Clinical and Expertise Relevance // *Kosmicheskaya Biologiya i Aviakosmicheskaya Meditsina*. - 1990. - Vol. 24, No 4. - P. 44-48.
25. Suvorov P.V., Sidorova K.A. Long +G_z Loads and Prediction of Their Tolerance // *Aerospace and Environmental Medicine*. - 1995. - Vol. 29, No 2. - P. 13-16.
26. Suvorov P.V., Artamonov N.N., Tarnovsky B.N., Bykova Yu.I. Lower Body Negative Pressure Tolerance of Pilots with Hypertensive Neurocirculatory Dystonia // *Kosmicheskaya Biologiya i Aviakosmicheskaya Meditsina*. - 1981. - Vol. 15, No 3. - P. 70-72.
27. Vasilyev P.V., Belay V.Ye., Glod G.D., Razumeyev A.N. *Patofiziologicheskiye Osnovy Aviatsionnoy i Kosmicheskoy Farmakologii // Pathophysiological Basis for Aviation and Space Pharmacology*. - Moscow: Nauka, 1971. - 356 p.
28. Chernyakov I.N. Protection of Crews of Spacecraft and Space Stations // *Foundations of Space Biology and Medicine*. - 1975. - Vol. III. - P. 395-416.
29. Chernyakov I.N., Maksimov I.V. Gas Composition of Alveolar Air at Different Altitudes // *Voyenno-Meditsinskiy Zhurnal*. - 1971. - No 3. - P. 67-73.
30. Chernyakov I.N., Maksimov I.V. Dehydration of the Human Organism at High Altitudes // *Voyenno-Meditsinskiy Zhurnal*. - 1967. - No 3. - P. 62-69.
31. Gozulov S.A., Golovkin L.G. Safety Support of Space Flights: In Yazdovsky V.I. *Kosmicheskaya Biologiya i Meditsina*. - Moscow: Nauka, 1966. - P. 363-391.
32. Ivanov D.I., Khromushkin A.I. *Sistemy Zhizneobespecheniya Cheloveka pri Vysotnykh i Kosmicheskikh Poletakh*. - Moscow: Mashinostroyeniye, 1968.
33. Maksimov I.V., Chernyakov I.N., Glazkova V.A. Decompression Disorders at High Altitudes // *Voyenno-Meditsinskiy Zhurnal*. - 1971. - No 8. - P. 69-70.
34. Isakov P.K., Popov V.A., Silvestrov M.M. The Problem of Human Reliability in Control Systems for Spacecraft: In Chernigovsky V.N. *Problemy Kosmicheskoy Biologii*. - Moscow: Nauka, 1967. - Vol. 7. - P. 6-11.
35. Bondarenko R.A., Malashchuk L.S., Kalinkin S.V. Enhancement of Antigravitational Tolerance in Aircrews of Shuttle Space Systems with Aid of Garment Made of High Module Elastomeric Tissue // *Actual Problems of Man in Airspace Systems. The Main Points of Reports of the First Scientific-practical conference (Moscow, 17-19 March, 1997)*. - P. 31-32.
36. Kukushkin Yu.A., Marasanov A.V., Zhernavkov O.V. et al. Soft- and Hardware Support of Flyer's Performance Estimation in Human Engineering Experimentation // *Problems of Cybernetics Simulation of Operator's Activity in Aviation and Cosmonautics*. - Moscow, 1990. - P. 118-126.
37. Isakov P.K., Ivanov D.I., Popov I.G. et al. *Theoriya i Praktika Aviatsionnoy Meditsiny*. - Moscow: Meditsina, 1971.
38. Bukhtiyarov I.V., Vasilets V.M., Sergeev A.I. et al. Features of Combined +G_z and ±G_y Stresses Influence on Pilot's Activity Performances // *Ergonomics. Ergonomic Problems of Aerospace Engineering Systems Design and Work*. - Moscow, 1993. - Issue 1-2. - P. 51-66.
39. Vartbaronov R.A., Khomenko M.N., Malashchuk L.S., Baranova E.V. Applicability of the Statoergometric Functional Test in Clinical Practice // *Aerospace and Environmental Medicine*. - 1996. - Vol. 30, No 2. - P. 44-48.
40. Stupakov G.P., Mazurin Yu.V., Kazeikin V.S. et al. Destructive and Adaptive Processes in Human Vertebral Column under Altered Gravitational Potential // *The Physiologist*. - 1990. - Vol. 33, No 1. - Supple.
41. Kalyakin V.V., Bukhtiyarov I.V., Vasiliev A.Yu. Study of Mineral Saturation of Lumbar Vertebral Bones in the Course of Systematic Exposure of +G_z Accelerations // *Aerospace and Environmental Medicine*. - 1996. - Vol. 30, No 5. - P. 9-13.

42. Bubeev Yu.A., Khomenko M.N., Polyukhovich V.V., Remizov Yu.I. Comparative Studies of External Breathing Gas Exchange and Circulation during Static and Dynamic Muscular Loads // *Aerospace and Environmental Medicine*. - 1995. - Vol. 29, No 4. - P. 32-37.
43. Stupakov G.P., Volozhin A.I., Korzhenyants V.A. et al. Changes in the Properties of Femurs of Rats due to Calf Exarticulation and Hypokinesia // *Kosmicheskaya Biologiya i Aviakosmicheskaya Meditsina*. - 1979. - Vol. 13, No 1. - P. 35-41.
44. Stupakov G.P., Moiseev Yu.B. Effects of Time Longitudinal Mechanical Load on Biomechanical Reactions of the Human Spinal Column // *Aerospace and Environmental Medicine*. - 1993. - Vol. 27, No 5-6. - P. 66-71.
45. Bayevsky R.M., Kukushkin Yu.A., Marasanov A.V., Romanov E.A. Method Evaluating Functional State of Human // *Meditsina Truda i Promishlennaya Ecologia*. - 1995. - No 3. - P. 30-34.
46. Chernyakov I.N., Shishov A.A. Maintenance of Vitality and Performance in Pilots by Means of Oxygen Complex in Emergency Depressurization of the Cabin // *Meditsina Truda i Promishlennaya Ecologia*. - 1995. - No 3. - P. 30-34.
47. Chernyakov I.N., Shishov A.A., Vorobyov O.A. et al. The Effectiveness of Hyperbaric Oxygenation as a Method of Increasing Human Body Resistance to Flight Factors // *Kosmicheskaya Biologiya i Aviakosmicheskaya Meditsina*. - 1990. - Vol. 24, No 6. - P. 21-23.
48. Barer A.S., Breslav I.S., Isayev G.G., Sokol E.A. Physical Performance and Cardiorespiratory Function in Response to Additional Respiratory Resistance // *Kosmicheskaya Biologiya i Aviakosmicheskaya Meditsina*. - 1990. - Vol. 24, No 5. - P. 20-22.

APPENDIX C

Psychophysiological Problems of Modern and Future Aviation

V. Ponomarenko

Office 12A

Petrovsko-Razumovskaya Alleya, A-83

Moscow 125083

Russia

1. Aviation medicine as no one other science and practice keeps under observation, explores, studies human being on the verge of his capabilities in hostile environment, where are displayed not only spiritual greatness and corporal strength, but disintegration of whole somatic systems. Psychophysiology in this case solves unique tasks to shape and to change the qualities of organism and personality, their physical, psychic, ethic and moral sources, which make the flyer to be fitted to flying activity in 20-25 years and to reach it's top during 20-25 years of life. Naturally the aviation medicine is involved in the course of aviation technologies research and development, technical learning devices, means and methods of psychophysiological training, formation of methods for health protection, maintenance of high performance and effectivity and prolongation of flying longevity. From this follows, that aviation medicine in contrast to technical disciplines appears to be an integral one, because this branch ensures human factor in all diversity of interaction with machines, control, communication, training, learning. The quintessence of practical side of this science comes to flying safety problems solution.

This task may be solved at two levels: subject-functional and system-purposeful. The subject-functional level is limited by traditional medico-hygienic problems of human life support system in aircraft cockpit. The system-purposeful level presupposes the investigations, based on human performance principle with consideration of pilot-aircraft system interaction in the process of professional tasks fulfillment.

The methodological foundation of similar psychophysiological studies is a system analysis. It signifies, that every element of professional environment, be it special flying suit, ejection and parachute systems, cabin filed of vision or signal devices and so on, must be considered not by itself, per se, by his natural qualities, but by systemic qualities, that is, every element must be evaluated on criterion of designated task solution and human performance assistance. The meaning of such approach consists in, that we, doing flying safety support measures, put forward not so much performance, as system "pilot-aircraft-medium" reliability. In such case a reliability is defined as probability to reach the demanded level of performance without detriment to health status and life of aircrew provided the full and perfectly safe aircraft control and preservation.

It rises the question: why I have distinguished and selected from aviation medicine the psychophysiological problems as having prominent and most important role?

First of all because, that we, aviation physicians, have to deal with healthy people and our sacral task --to protect and to preserve the professional health, which guarantees the high level of human factor reliability in conditions of extremely unfavorable to health. It follows, that the fundamental psychophysiological problem is the system analysis of all risk factors, which may cause damage to aircrewmember's health, still on the initial stages of aviation technologies research and development. The practice must know, what extremal factors will sensitize pilot's organism, provoke the changes of his immuno-reactive reserves, lead to weakening of his natural adaptive capabilities. What are the most probable stressors and what role they play in a pathogenesis?

Anticipation – is the only reliable method to organize the multi-component system of prophylactic measures, in particular, the development of human psychophysiological readiness to mastering of a new level existence, arising on the base of technological innovations and inventions. The depth of our foreseeing and anticipation characterizes the effectivity of scientific achievements on the following criteria: the duration of professional longevity, the specific weight of professional illnesses and traumatic lesion, the quantity of flying accidents due to health deconditioning or decreased psychophysiological reliability, per cent of individuals among flying personnel, repeatedly admitted to flying activity, the grade of ergonomic comfort of a new aircraft cabin design for aircrewmembers, who fly in it.

2. Ever – changing regular rearmament of aviation weapon must be provided with change of flying safety tactical medical support. The point is, that the new highly advanced technology, the new methods of it's employment do change not only the psychophysiological content of professional operations and activity, but may alter one's mode of living, modify the needs and the motivations: So I would like to attract your attention, that among psychophysiological

problems we in any case might not neglect, ignore or omit from our focus of view the personality of flyer, it's individuality.

The new generation flight management systems, electronic flight indication displays, automatic control radically change the structure of flying professional skills, forcing out the simple sensory-motor actions, ousting them by intellectual and rational operations. It is significant, that in manual regimen of flying, when pilot himself plans and prognosticates the change of controlled aircraft's motion, his organism strictly reacts depending on influence of gravity factor, where as in automated regimen of flight control in similar situation he reacts by generalized arousal, that is by excessive overcompensation. The said above means, that automation of flight control expands flying maneuverability and aircraft performance as before at the expense of human factor.

Progressively improving flight performance characteristics of modern highly maneuverable aircrafts, prolongation of their flight duration time favour to appearance of new, early not known combination of detrimental factors, and it is true in the course of one and the same flight. Here they are: hypokinesia and prolonged accelerations, monotony and operational readiness, shifts of temperatures, light and shadows contrast regimen (leap of brightness), circadian rhythms alteration in transmeridian long-haul flight, electromagnetic radiation effects and so on. All these features redistribute in a new way the hierarchy of risk factors of fatigue, cardio-vascular, nervous and locomotor diseases, that in turns demands a new approach to flight duty limitation, to the organization of active recreation and rational nutrition. One of the prominent traits of modern technique lies precisely in what against background of increasing ergonomic optimization there is a powerful intensification of psychic loads, there are put in an appearance the new nosological forms and disorders, as a remote result of flight information factors effect.

This compels me to attract attention of aviation physicians to the psychophysiological problems of flying labour. I think, that the expansion of knowledge about human psychophysiological reactions will permit to aviation medical officer to plan his or her work more promptly, more effective, beginning from participation in flight load schedule planning to clinical differential diagnostication of flyer's morbid and changed functional states.

3. For flying labour the psychophysiological problems are determined by specific conditions, in which runs the psychic activity of pilot or aircrewmembers. In this case the notion "specific conditions" means, that above mentioned conditions either totally absent in usual earth environment (for example, the substitution of fulcrum by the resulting G acceleration), or do not have such manifested influence (hypoxia, vestibular irritations etc.).

The final result of psychophysiological investigations is the determination of borderline, which separates the norm and functional disturbances, which defines compensatory limits of vital functions, human compensatory reactions as well as their individual systems.

Let us dingle out the leading psychophysiological problems of flying work.

The first psychophysiological problem of flying activity is ensuring of flexible adaptive responding to rapid shift of physical conditions for perception of habitual external environment. From the first instants of take-off there has been changed reflection of familiar environmental world, the perception of items occurs in unusual foreshortening, in other spatio-temporal range, so pilot's spatial orientation involves the formation of mental transfigurations of visual information. It means, that pilots spatial orientation demands selective and active direction of consciousness, awareness for constant intellectual appraisal and verification of perceived flow of instrumental information comparatively correspondence between his own spatial motion and preplanned flight task. In his everyday condition the human being reflects visible world, but in flight there have been occurred false perceptions, visual illusions and aberrations, that's why pilot must apply his mental efforts to transform erroneous and ambiguous position into real and true one. It signifies, that man in flight in addition to flight task must perform second purposeful action – spatial orientation.

Therefore, the spatial orientation, and, if this term is to be determined in much broader sense, that is, as reflection of movement in space and time against a background of distorted force of gravity, is a first psychophysiological problem of pilot toil. Precisely with this problem, and just in close connection and relation to it, are latent persistent flying phobias, neurotic conditions, negative fixed psychic attitudes, loss of flying motivation etc. This is one of key aeromedical problems, because many disorders and conditions are manifestations and symptoms of that still unresolved issue.

The clinical mentality of aviation physician is impossible without serious acquiring knowledge about the psychophysiological mechanisms of spatial orientation. As a result of underestimation the importance of this fact we have still, as before, approximately 20-30% of flight incidents and accidents, in which spatial disorientation of pilot

plays a paramount role as main cause of flying errors, unreliability and non-effectiveness of actions with various sequelae to cabin aircrew performance.

I find it necessary to give here full credit to American researchers and pioneers in spatial orientation problems investigation. I was struck by paper of pilot Marlowe, who interpreted the spatial orientation problem as “Achilles heel”, and his colleague, US Air Force flying physician Geoffrey B. Mc Carthy, who had reviewed the spatial disorientation incidents among F-16 fighter flyers. It must be mentioned also very interesting findings, published in a paper by Lions and Simpson, who for the first time have had described “the giant hand phenomenon”. Some other materials together with named above suggest, that spatial orientation problem is really transnational one and it might be a common point of joint international scientific cooperation.

The moral stimulus for such mutual interaction must be a tragic fact, that about 54% of all flight incidents and accidents are caused by spatial disorientation events, though formally official statistics registers only 25-38% of such cases. This discrepancy is stipulated especially by the fact, that incident investigators and experts primarily consider, in general, the cases of full loss of spatial orientation. At the same time, if you, being in process of crashed aircraft flight-recorder investigation, have found a large amount of searching probationary (“trial and error”) control movements during complex aircraft attitude position, or attempt to pull out the flying machine from steep dive without roll alignment, or full absence of any endeavour to diminish gas turbine rotation number – all these phenomena are the significant indications of pilot’s partial loss of spatial orientation. As to modern generation fighter aircrafts, there have been occurred new conditions and attended circumstances, which facilitate the spatial disorientation of flyer up to full loss of flight attitude control. Among such conditions I rank:

1) The broadening of simultaneous solvable and highly motivated first priority flight tasks circle, including air combat and ground attack targets, an excessive level of automation, which inevitably lead to decrease the level of conscious control of aircraft attitude spatial position;

2) The augmentation of instrument flight rule exercise quota during the stage of primary aviation cadet’s training, which impoverishes and makes destitute the perceptive substance of flight image;

3) Inordinate overloading of brain blood circulation system, the effect of signalternating (plus or minus) G-stresses against a background of locomotor system shut off, sluggishness of pilot working posture due to limited cockpit volume, strengthening of pilot oculomotor activity in relation to angular (rotational) acceleration of out-of-cabin environment, and all that together with insufficient informational provision of psychic processes, is responsible for spatial orientation.

The second psychophysiological problem of aircrew flying activity is an ensuring of pilot aimful behavior in attended and interconnected command actions, when demanded aircraft control effectiveness is achieved by formation and development of new systems in behavior control. Exactly the combined actions in unique time scale can not be supported exclusively by stereotyped skills. It is common knowledge, that conditioned reflective forms of cognitive behavior allow to pilot to get signal information and to be orientated in external flight situation. But the psychic form of reflection gives to pilot possibility to perceive the semantic essence, the thoughtful stuff of signal. It is in this level of reflection has been formed an image (“Gestalt”), that is information allocation in which are enclosed the legal relationships of object.

Consequently, the behavioral act, especially in new situation, is controlled not only by involuntary, automated mechanisms, but by images of preplanned and anticipated actions too. Hence it follows the psychophysiological problem of behavioral mechanisms restructuring, cognitive learning on the base of combined use of automated and newly acquired skills in the aircraft flight control process and its system too.

This is a matter of principle for aviation medicine, because a lowering in pilot reliability, as a rule, happens precisely in conditions of pilot time-shared flight control activity. The problem of competitive or time-shared activity in psychophysiology has gained a special role due to appearance in flight management systems of plurimodal warning signals: acoustical (tonal), voice speech, written form speech, tactile, proprioceptive, visual, which have various sense and various pragmatic meaning. I dare with full responsibility to say, that many misfortunes and disasters, which happened to be with pilots an aviation practicing physicians, have its source from technocratic principles, that is, when flight information display and indication systems, even the most perfect from technological point of view, are constructed without consideration of pilot psychic relationships of flight image formation.

Today the Hi-Fi and most advanced information processing technologies in the form of instrument panels with vertical and horizontal flight situations indicators on the base of computer graphics achievements didn’t get rid and

eliminate such drawbacks, as overloading and discomfort of psychic reflection of pilot during thrust vector control of his aircraft motion in spatiotemporal flight trajectory, because:

1. The parallelism (duplication) in use of symbolic and natural indication of aircraft attitude position in air space.
2. The simultaneous superimposition on transparent head-up narrow angle out-of-cabin view display of the main flight controlled parameters.
3. Rapidity of schemes orientation change-over from egocentric referenced coordinates to geocentric referenced one, from plane to perspective picture and so on. Hence follows and it becomes clearly, that the task of psychophysiology involves the search and finding of optimal information form in aircraft display, on the base of neurophysiological mechanisms of Higher Nervous Activity.

In aircraft manufacturing technology the results of psychophysiological explorations are used for design of flight management system, flight display, pilot alerting system, voice or written text advisory systems. The psychophysiological recommendations also have been employed in aviation cadets flight training, during the transition of experienced pilots on new generation aircrafts and mastering of complex air combat maneuvers.

The third psychophysiological problem of flight performance is an issue of stress. Psychophysiological problem of stress is characterized in what the process of flying pilot's emotional arousal has been accompanied not only by "hormonal explosion", but by behavioral disintegration too. Dynamics of hormonal syndrome deployment under effect of stimulation, addressed immediately to flyer's psychic sphere, is dependent on prognostication of planned or extrapolated actions, on threat degree evaluation to pilot's life. The experience of psychophysiological investigation of pilot's behavior and sensation in endangered flight situations has suggested, that the signal significance is a main controller of adaptation reaction power.

The stress problem as physiological issue has been investigated in detail. In this relation I shall state some opinions, concerning to sociological component in psychophysiological problem of stress as a whole entity. If we admit, that in flight practice the force of stressor is determined not so much by itself (thing per se), as by its significance to pilot, so we must recognize and outline the stress problem in flying activity as a problem of personality. The intrinsic, vital force of personality, its stamina in professional menace situation, the best example of which is military flyer's hard work, is founded on moral basement: overcome, surmount, do good, defend.

Ignorance, poor morale and feeble body will result in grief and sorrow of other people. In such way of problem putting the tolerance to stress is by no means a hormonal syndrome, but rather pilot personality's social activity. Henceforward, the tasks of scientists and aviation physicians sub specie pilot's stress tolerance ensuring are following:

1. The creation in pilot performance interests of such social community, which would guarantee to them, that is to flyers, the realization of their voluntarily chosen the right to risk, the right of independent highest moral choice and decision in event of real threat to life.
2. The ensuring in flight training of psychologically adequate conditions, which aim and activate in aviation cadets those psychic processes, states and functions, that is, those qualities of organism, which in its philo – and ontogenetic development were not enough adapted to such factors as a change of gravitation vector in flight, a compression of time and space, distorted perception of substantial environment, metabolic intensification etc.
3. The formation of psychological orientation in mentality of H.Q command and flying academy instructor personnel to pressing demand of tolerance in relation to non-standard, non-stereo-typed behavior of subordinate cadets and flyers, in case, when their behavior deviates from prescripts and orders. To understand an essence and roots of pilot stability stress, in my opinion, means, to consent to conception, that man of dangerous profession feels constant need to widen the limits of risk and this is a hidden, inaccessible to our glance protective reaction in suppression of subconscious emotions of fear. In this case the risk emerges as mode of achievement of high degree professionalism. I would like, in presence of such authoritative audience and highly respectful workshop of practitioners, to tell aloud a free thought, which as a matter of fact comes to the following thing. Unreliable actions, as result of stressors effect, among professional people do occur not owing to poor skills, or emotional instability, but they are a manifestation of diminished activity of person, when he or she has lost his or her dignity, when develops a "paralysis" of will, or much worse – a disgraceful syndrome of "hiding behind the other's back". It possibly is not so important for You, but I am, for some reason, fully confident: the flyers may be of all sorts, but the sky is one for all and the earth beneath them, although their native and own, is solid and hard.

Psychic state of pilot in flight conditions is the fourth psychophysiological problem.

Under the concept of “psychic state” we comprehend specific manifestation of psychic processes interaction during the fulfilment of routine flying work and operations. As distinct from vegetative reactions, accompanying the behavioral acts and reflecting energetic side of adaptation process, the psychic states are determined by informational factor and organize an adaptive behavior, considering the individual features of concrete man. An analysis of so called non-adequate pilot actions in mishap or accident flight situations has clearly shown, that as a result of even feebly marked alterations in psychic condition, for example, under prolonged dominance of one from the psychic processes above another, begins the disintegration of whole reflection, that is, there occurs the situation of unaware errors of judgements or actions. Henceforth there may be languid vegetative reactions to extreme threat to life, which characterize not so much emotional-volitional stability, as changed psychic condition, which had led to change of pilot subjective relation to objective situation aboard an aircraft.

Results of psychophysiological research works and studies of pilot psychic states make possible in profit to flying safety support to differentiate two close related notions – “performance” and “reliability”, inasmuch as pilot in state of capacity for work always controls the effectiveness of his flying activity, but unreliable actions owing to his psychic conditions he not always becomes aware. The modern flying labour goes on in conditions of combined influences of hypodynamy, psychic strengthening, desynchronosis, augmented social responsibility. In relation to power of these unfavorable factors there are very much in evidence such morbid conditions, as nervous exhaustion, state of anxiety, over-fatigue, fear of flight etc. The disclosure of pilot psychic state mechanisms, the discovery of differential diagnostic signs and development of rehabilitation measures in order to reinstate his healthy conditions are new problems for psychophysiology of flying work. From the point of view of flying safety let me now to draw your attention to the least studied and known conditions, which I’ve designated, as a state of compulsory motive. This state develops at the attempt of flyer to land his aircraft “at all costs”, at any rate, especially, in instrument flight rule conditions, in the situation of alarmed rest of fuel, due to partial aircraft faults and failures. The psychological core, of that obsessive motive, manifested in psychic state of airstrip (runway) expectation, consists in what has deformed his consciousness, as you call, according to accepted in that country terminology, “tunneled” vision. It is important to note, that man in this state makes regular errors, as his psychic reflection of flight situation has been distorted. Actually the same is so characteristic to hypoxic state, when there has been developed the complete disintegration of psychic reflection as to side of partiality, as to side of full indifference. In experiments, carried at our facility, in which we had modeled the various psychic states under influence of hypoxia, pharmacological agents, shifts of psychic attitudes etc, we have had got some principled objective laws. Let me now acquaint you with some them.

1. The psychic states present a formation processes of environments conceptual idea or mental representation in consciousness of pilot. In some cases these conditions have deprived the psychic (cognitive) processes of their systemic qualities, and in first line, they have changed the pilot’s mental attitude to the effectiveness of his own actions.

2. The changed psychic states have provoked the disturbances of pilot awareness of flight situation at the beginning at the operational level, then at appreciation level and finally at semantic one.

3. The psychic activation as such may reduce the professional reliability due to lending to separate psychic process a dominant role in behavioral control.

Proceeding from above even in such brief survey, I dare to tell you, that a problem of pilot psychic states still didn’t deserve his noteworthy place in explorations of modern aerospace medicine.

4. The psychophysiological problems of future aviation are determined by character of advanced aircraft manufacturing technologies. Regretfully, my experience suggests, that technological progress in the nearest 15-20 years will lead to substantial augmentation of various target tasks shift rotation, and I think, it’s value will be approximately equal to 90%.

This supposed Hi-Fi peculiarity will initiate a further energetic increase of pilot cognitive workload, it’s most difficult intellectual performance, connected with image, verbal and abstract reasoning. From the psychophysiological point of view this specific trait means, that the psychic activity controller is a mechanism of constellation of dominants. Exactly this circumstance will provoke an extreme and exceptional overstrengthening of pilots intellectual functions, without an interruption for physiological pauses.

In connection with what a progress in aviation means further engine power thrust rise, redundant information saturation, still greater jump and “gap” from human nature being – it should be reasonable to expect the acquisition of newly coming features by already known to us risk factors. I think, that we shall be worried not so much about new risk factors, as about qualitative changes of old ones. For example, if we’ll force human pilot to control his aircraft in supine position, I’m strongly convinced, that afferent physical signals from gravie receptors will acquire a new specific meaning during the spatial orientation formation. And if we’ll compel the pilot to use abstract information about motion of aircraft in time, we ought to expect the new forms of disturbances in psychic reflection processes, up to personality mental dissociation.

I look forward, that introduction of advanced know-how and computer technology will enable us to create a new technological break-through in expert diagnostic systems. These systems will make possible to detect and identify the level of pilot professional health his psychophysiological readiness to specific flight tasks considering their intricacy and capabilities of individual.

It is a matter of development and construction of automated systems for pre-admonishing or ante-nosological diagnostics, medical check of healthy pilot psychophysiological resources level, and, at last, the systems for prognostication pilot work capability in relation to quantity and type of risk factors, which effect human in specific flight.

All these new distinctive marks of future aerospace medicine demand from us a philosophic comprehension, because the results of similar scientific elaborations, R & D achievements might oppose to interests of practice. Today the aviation medical practitioner routine task is not to admit a sick aircrewmember to flight, so any technological novelties have been used exclusively for medical diagnostication. I anticipate, that if we do not change our attitude and conceptual set to flying safety medical support from position "veto the sick aircrewmember to fly" to position "protect health of yet healthy flyer", every medical information database and retrieval system with artificial intelligence of any kind, will be used not for prognostication, but for more strict and rigid standardization, that inevitably would contradict the flying tasks. I suppose, that in future it would be rationally to foresee on board of aircrafts "the human module", which could control cockpit environment regimen in order to maintain high level aircrew work capability and performance, especially in case of pilot's psychophysiological resources exhaustion. At present time we have constructed and experimental onboard system of continuous medical check of pilot consciousness in order to block every possibility of aircraft loss control, even in partial disturbances. This probing autorecovery device has put in action supplementary means, which ensure the full and complete restoration of pilot performance.

New research and development works in the field of biochemistry have instilled hope to our researchers to find the biochemical signs, which would relate with functional psychic disturbances in actually healthy flying personnel. The studies have shown, that in aircrewmembers with psychoemotional disturbances there had been tracked rather stable complex of combined hormonal regulation alterations: the shift of peak in diurnal catecholamine excretion to morning hours, the depression of corticosteroid and sexual hormones concentrations, the decline of cytoplasmatic enzyme activity, plasma immunoglobulin G accumulation and some other date. Moreover, there have been revealed the correlations between biochemical indicators and personality psychological profile. For instance, in persons of depressive profile type, the characteristic biochemical signs are determined by prolactin and somatotropin plasma level augmentation, by increased concentrations of creatinine, triglycerides, excessive production of immunoglobulin G. It is worth to note here the predominance of anterior pituitary gland hormones activity in persons with emotional trauma. There have been also established the biochemical correlates in persons with increased anxiety states. The value of these experimental studies consists in what their results may orientate the flight physician intuition to possible reaction types in flying personnel of still unrecognizable, prenosological conditions and states.

In our expert systems we have widely used the biochemical data for foretelling of pilot health exhausting effects of such extreme factors, as vibration, aviation noise, cockpit air temperature, electromagnetic fields.

I have cited all these facts as an example of great potentialities, inherent to aviation medicine, concerning the successful replacement training of military aviators in a new technological environment, which is being prepared for them in bowels of advanced Hi-Fi progress. Being a research worker and at the same time an aviation medical practitioner, I feel, that future development of aviation is linked with necessity of resolute transition from epigonous decision tactics to strategy of preplanned scientific anticipation of military flight physician demands.

And now let me, Distinguished Colleagues, accomplish my lecture on major key, whatever in aviation medicine happens, we, aviation physicians, will never shame our sacred cross, our reverential duty – to bring to aircrews goodness, wisdom and holy news.

I'm very pleased to tell all you appreciative audience my professional gratitude, thanks to the fact, that we all live, belong and attach to the country, whose name is AVIATION.

APPENDIX D

Pilot Interviews

Fred KNOX
 The Boeing Company
 Mailstop 4C-26
 9725 East Marginal Way S.
 Seattle, WA 98108
 USA

RTO WG 27 SUPERMANEUVERABILITY

Transcript of Fred Knox and Nellis AFB Pilots with WG 27

19 May 1997
 Nellis AFB NV

Mr. Fred Knox: Several years ago when I left operational navy and became a navy test pilot, I lost some credibility. Then several years ago I went to work for Boeing and lost all credibility (laughter). As contract/test pilot, I know when I am in an uphill battle. O.K., so lets do it. And the reason I am here, you hear their (referring to the RTO WG27) subject matter, supermaneuverability and anti-remaneuverability, I think we together are the guys who are worried about air combat and in particular air-to-air as we stay in speed, but we wanted to gather a little bit for stuff down the road and pull you into environments for future airplanes potentiality. There have been a couple that fly and do a somewhat exaggerated maneuvers: X-31, F-18 HARV (high alpha research vehicles), F-16 MATV (multi-axis thrust vectoring). I don't know if you remember but they put a vector nozzle on the X-31 and in the other series the F-16C and F-15C. And we used the Fighter Weapons School to try to do a little sanity check on us old contractor guys. Our baseline was an F-18 as an adversary, so they wanted to chat a little bit and I think this will at least open the forum up about the requirements for those kinds of future airplanes. And not to short circuit any debriefs, I didn't want to cut my trip short to Las Vegas so I came with my briefing, everything we saw in the X-31 type maneuvers as far as restraints, displays were the same as you would have in any fighter airplane. We didn't see anything that said you have to have a new capability, new restraint system or anything. They are fairly low G, 6 and below, zero-side slip, low acceleration, and slow-speed fighting maneuvers. So they work great for what we had. We had another that flew a helmet some, a Viper 1 (monocular helmet). So the carefree airplane was a real answer. I have a short video then will get to the discussion story. Primarily it was to give everyone a feeling, particularly the gentlemen here, what maneuvers look like in three dimensions. It's the Paris Air Show tape from 1995. The reason I am using this one is because it is low to the ground so we can see the stuff. The maneuvers are somewhat different from the normal air show, not to be purely doing air show. We picked maneuvers that are only significant for a supermaneuverable airplane. We might use them for real, so as each maneuver is flown I'll give a couple seconds on how we set up tactically. And again so that I don't get too many arrows and spears, we were focused with the primary task of evaluating close-in-air combat, narrow focus, 1 versus 1, and a limited scope. MATV did a little 1 versus 2, but we were focused 1 versus 1, close-in-air combat. We used AIM-9Ls (missiles), and guns, normalized weapons, across all the airplanes just to try to get some deltas with the airframes. If I don't get any hard questions at all I'll get shot, this usually gets a little debate going at some point.

(Video Presentation of X-31; Fred Knox narrates)

Mr. Fred Knox: The only difference is, symbolically, that as you look at the left scale, Alpha scale is alpha and they all go up to 70 (degrees). That is primarily for flight tests. The top indication is in tenths. That is side-slip and you very rarely see over 2 degrees. As the ground gets closer they were doing that stuff. I'll leave this one run for a few seconds. This was actually the hardest part of the show. For every one that gets asked to go do these things, make that your number one objective. That is my biggest lesson to learn today for air shows. It is survival. You'll be real happy. Do that first. I think that parts (leads) to discussions. I am not sure what you want to do, Col Lyons but I can think of a few things that can probably get you started if you want.

Col Lyons: I think the first question is what is the future going to look like as far as the air combat arena and what kind of things do you see as going to be utilized in ten or fifteen years time? As a laboratory sometimes we have separate programs. We have programs on increasing your capability to 12 G. We have experimental subjects going to 12 G in

the centrifuge. We have guys working on negative G. We have guys making a G suit that will help you pull negative G. We have helmet mounted displays, and we have guys looking on unmanned aero-vehicles, and other people looking at supermaneuverable vehicles. But in general, we have people arguing. Everyone argues that this is important and this is important, but I think the idea is to figure out where you, the customers, are going, where you see things as being in ten or fifteen years, so that you are ready to meet there when the time comes. Instead of us arguing internally about what the future is going to be like, I would like to get some feedback from you as far as what you think the future needs of the Air Force will be in a ten or twenty year time frame.

Pilot #1: Number one, we don't have the capability to positively identify the equipment that can BVR (beyond visual range) environment, the killing that can BVR environment, in failing that or constraints otherwise that can't be done. You want something that is superior in all aspects and within visual range of environment. Weapons, maneuverability, sensors, and the kind of aircraft that it is. Not even close, parity is bad.

Col Lyons: Right, right. Well that discussion came up with the French test-pilots, actually the business of beyond visual range. In fact it seems that one of the primary drivers for the need for close in capabilities is the fact that we have to visually ID.

Pilot #1: Even given perfect capability in the BVR environment, I think you are always going to deal with scenarios, in which a) you politically can't do that, or b) something just happens. You find them all, you ID (identify) them all, you kill them all and you kill all but one. There is always going to be several different scenarios that is always going to get you there.

Col Lyons: Or the Stealth issue, I suppose.

Pilot #1: There are lots of avenues to which you can arrive at that situation. I don't think you are ever going to legislate or develop or research to 100%. So given that you can not get there 100% of the time, assuming you have unlimited funds and technology and everything else, it gives us the capability in that environment to surpass parity just by leaps and bounds, granted there are a lot of reality that you have to put into that. Maneuverability is obviously one of the weapons placed in the aircraft and the sensors, when I say sensors I am talking about everything from weapons to radar to the amount of displays to the weapons and their capabilities in that environment. There is nothing but an exclusive kill and capability for everything.

Mr. Fred Knox: Did you guys see your task starting, at what point in the engagement? 100 miles? 200 miles? From a paper I read at lunch time just looking at the agile systems I guess, how far do you go, do you go off aircraft sensor agility how big is your scope I guess?

Dr. John Firth: One of the points is what do you call superagility.

Mr. Fred Knox: That is what I mean. It is a broad definition.

Dr. John Firth: There is maneuverability which is the airframe. But Agility is airframe plus you chaps in the air, how do you put your marbles together, and how the system can support it and weapons and everything else that gets in the way. Because there is no doubt that you are going to be up against what is present day terms are superagile aircraft. That's where Sukoi and MiG are now going and they're selling them throughout the world. So whether or not we believe in this, it's there. So our first problem as medical men is where is the frontier now. The F-16, the big engine, if that is what agility is divided into we need to describe that. And because you are right at the fence you can probably see over the fence better than we can, a long way back. On the other hand, we need to all work together because as we came to helmet mounted displays and so on, that was all believed about thirty years ago, but at that time it was considered an absolute waste of time. Now, it could be one of the key parts in the agile environment to give you that quality and superiority in equipment that you are going to be flying in.

Col Lyons: Do you want to give me your list of brainstorming ideas?

Dr. John Firth: I think actually you should have gotten copies, in fact you probably got my copy so I am going to be lost, but one of the problems of being medical men and we have some of the distinguished people with us here and I certainly feel very humble being in this country with the aircrew and everyone else, but one of the problems is we all have fairly small points of view. So the two little pages coming around are an attempt to define, and that's not the ultimate definition, but it is a starting point. And we would be very grateful if you would tear those to pieces. In fact if you completely rubbish them, so much the better. And secondly are the scenarios, rather simplistically, that we see in which superagility may play a part. Because as you say we can have the most sophisticated weapon systems in the

world, which will always be caught sooner or later, low or show, or you will always be caught in a corner for political reasons or for one reason or another, and the other chaps will be at their advantage. Just as Chenault in China did nothing but bounce Japanese and had the best kill ratio of anytime in any air war because he would only fight when it suited them. Unfortunately, we have to be prepared to fight when it suits the other person in that sort of way, because we will always be the corner. And yet if you would have the control of the air, you have to control the small corners as well as the overall part. So the first point of the paper is to try to ask your advice. The only reason for coming here is to hear what you say not what we think. Because we can always come back at you and say does this make sense and hopefully you'll rubbish that again and by the same direction we can make our way forward. I think I have probably said enough because we need you to better our ears with your opinions and your experiences of what the reality of what the present frontier is with agile aircraft and where you see those limitations having a major effect and where you think we ought to be pushing those and where we as medical people can make sure we support you into those new areas.

Pilot #1: When you talk about frontier, do you want to step through it because we can look at global all the way down to 1v1, 500 ft apart? It is kind of a large thing.

Mr. Fred Knox: That's why I ask. I am not sure which part they are most interested in.

Dr. John Firth: Well I think if you talk about superagility, it has to be from 1v1, which may be that small corner. But then it could never be 1 versus 1, it is always 1 versus 2 if you are unlucky, or 2 versus 2, so it is always more complicated than it seems. But then of course it takes part in a greater scenario, so the whole system has to be agile as well as the individual pilot and his equipment on the spot then. We are charged with looking at superagility globally, so that includes the individual, the individual aircraft, and the individual systems.

Pilot #1: You could probably start from big and then work your way down to the smaller 1v1 maneuverability and weapon system. When you start out big what do you want in a extreme long range environment?

Dr. Grant McMillan: Do you see a role for supermaneuverability when you are BVR?

Pilot #1: Supermaneuverability no, but superagility, yes. If the definition of agility that we are using is if I am sitting around flying my aircraft and I know that every single thing out to one hundred miles of my aircraft no matter where it is no matter what it is I know what it is doing relative to me. How do you detect, how do you ID, how do you display all of that information is actually a pretty big task. And what technologies are you going to use to do all of that? And more specifically, if you have the technology to do that how are you going to display this to a pilot in a way that is a) timely, temporal, b) that is easily understood and there is no mistaking and all of the limitations of the technology? What are you going to be able to do about that? Do you have the capability to do something about that if it is your intent? For example, the F-22 does it. Starting out it is 100 miles under this, 80 miles under this, 60 miles under this, 40 miles under this, 20 miles under this in global rings, so starting at under 100 miles can we detect and display everything in the aircraft, at 80 can we ID it, at 60 do we have the capability to use the weapons quality informationally. That is one of the big display type issues.

Col Lyons: Weapons quality means their or your weapons quality?

Pilot #1: That is going to come into it with the design of the cockpit. Whether it will be able to display all of the information. Back in the F-4 days the biggest problem was a lack of information. In the F-22 days and beyond that, the problem is how do I take all this information and pare it down to a format that one human being can understand everything I am trying to tell him. Then you always have the question of the accuracy of it. We are assuming the information is accurate. In a superagile aircraft, we are talking about in a BVR environment, the onboard surfaces and offboard surfaces knows everything is out there and is able to present this in some type of format to the pilot which is understood and you are going to have to take that same thing and march in all the way and start with your priorities and look at all the integrated systems and prioritization and everything that is going on. All the way down to and include, when I get into this 90 alpha or 90 units of AOA (angle of attack) or 90 degrees of AOA and I am trying to control this thing and kill things with a helmet mounted sight, still have the requirements to present all this information whether it be on a helmeted mounted display, heads-down display, or however else.

Col Lyons: What you would be interested in would be the changes?

Pilot #1: That's what I am saying. As you walk it in you have to be somehow able to prioritize that information or declutter that information.

Col Lyons: The system should know actually how to do that. The system should have an idea of what was of interest to come. It would prioritize that information for you.

Pilot #1: It does to some extent, given a standard default if you will, that you have to be able to communicate with the system to say, O.K. the system says this, this, and this. O.K. that's fine but in this situation I want that so there is a lot of interaction that has to go on in order to change the priorities for example you are sitting there going 80 miles I got this, and 60 miles I got this, and 40 miles on everything out there. If I hear quote-unquote "single target track" on somebody at 100 nautical miles will be able to override the priorities of what the system is telling you or in the event that I switch back to a SRM (missile), just a generic SRM, and I start turning my head I ought to be able to tell everything on the airplane if I am pointing to that missile over there, it's probably for a good reason. So, don't concentrate all your efforts over there maybe you want to swap some of the majority of your processing capabilities to this side of the airplane as far as missile launch detection, all the different VCM's (visually coupled missiles), cueing going on in the aircraft.

Pilot #2: I think one thing that the aircraft will have trouble doing if the pilots still need to stay in the loop is threat prioritization. I think that's where the man is going to stay in the loop possibly for one of the longer times because it's tough to get sensors to be able to analyze what threat, where is it at? Where am I going? What's my mission? So I think the threat prioritizations is where we stay in a loop and we can get systems up to a certain point based off of distances, types and things in a certain range. And I think that is where we will be in a loop for a longer time than some of the other problems that are solved by their technology.

Pilot #1: And that argument assumes 100% detection, 100% accurate identification, and is still letting me make the decisions to a certain extent of the priorities of what is going on. The system can tell you a lot. I mean, for example, the detection of SA-2 (Soviet surface-to-air missile) at 30 miles and it detects a SA-6 at 30 miles, well if they are both 30 nautical miles away from me, it ought to be easy for the system for a SA-5 and SA-6. It ought to be easier for the system to tell me that at this range the SA-5 is probably a bigger threat to you than the SA-6 is. However, you won't do anything with this information, but it ought to be fairly easy to do. But if I got a SA-6 (Soviet surface-to-air missile), 3 miles away and a Flanker is locked to me 8 miles away and I don't think the system...that is where he was saying as far as you know you determine priorities.

Dr. John Firth: Would it be one way of doing this is to really break down what you are asking for to two orders of information. One is strategic, what is going on as far as you want that would be the easiest amount on the big screen, the other is tactical information on what is happening on your part of the world within that volume which you could influence. And what's going to influence you and that information would be put into the helmet. So that means you have insight. Does that seem acceptable?

Pilot #3: I would think that the error between those two is going to be pretty big. I think one of the big challenges is going to be the approach. There is going to be a lot of gray area between the path of the strategic thinking to out based on the ranges of today's weaponry. Something out of 100 miles will be tactical while at 10 miles will be strategic. Prioritization based on such that will be the biggest challenge with that type of speed all of the gray areas between the strategic and tactical.

Pilot #1: I agree. I may disagree with you that the physical limitations of the displaying a certain amount of information and something as small as current helmet mounted sight technology or a badge on the helmet if you are talking unlimited technology and funds again if I can put all of this on the visor so no matter where I look there will be a lot of problems with just a lot of PVI (pilot vehicle interface) problems. I don't want all that information. How can I get that information when I want it? Do I want it on displays inside of the cockpit do I want it on the canopy or do I want it on a holographic three dimensional image around me that I can control somehow with my hands, with my voice, with my mind. Somehow you need to get all that information there. The key thing right there is a) do I have enough information given in this scenario and b) how do you present it in such a fashion that one human being or two human beings can simulate the information and do something about it before you go to the next step or another step or take the pilot out.

Dr. John Firth: The trouble is if we take you out and leave you in an arm chair here to fly your UAV the situation exactly the same just as you aren't on the spot to display initial imagery.

Pilot #1: I think that would be harder.

Col Lyons: What are the limitations of not having you there? Are the communications link lag, the built in lag in the system? It seems to me that vision is one of the key things to..., I mean there seems to be a lot of things that we can

display but I don't think that synthetic vision is really, I don't know. What's your thought on that? But that seems to me. Of course in air combat something is not preprogrammed like air combat seems to be the most difficult thing to get the drone to do. Cause the drone cannot actually see it.

Pilot #4: I think one of the biggest considerations sir, is also that every pilot and aircrew member is unique in one way or another and to just have a system that displays strategic on one scope and tactical information on the other. That may work for one guy but it may not work for another and my input would be I would like to see a system that I could personalize and tailor when I get into the airplane. If I wanted to display strategic information on a big CRT right in the middle I could do that and if I had a couple of smaller screens for other information I could pick what goes where you know and how much of that big picture I could pull off and go stick over there and then I can maximize it for me. Lt Col Yauch could maximize it for him and he may like look in different places for different information but it doesn't matter because each guy can personalize it to the way they like to see it displayed.

Col Lyons: How standard is the way you use your instruments now? Do you select different pilots, do different pilots have a different way...

Pilot #2: See everybody in this room flies. Your not very familiar with what the capability is of the back seater. I mean we have all federated systems. We have a radar display. There is nothing...

Dr. Grant McMillan: You can't do much personalization with those displays.

Pilot #8: Actually, we have three different screens in front and four in the back with about 20 subunits that can go in each screen and I know that there is some standardization among the screens and there's a lot of redundancy but no two aircrew I have ever seen fly exactly the same. They tailor for their habitat patterns and based on mission specifics. They also flip their screens because we'll have different set ups based on whether you drop in EO (electro-optical) type weapons or you have to insert a target pod, or throw in air-to-air and our screens will change throughout the flight also.

Col Lyons: Different guys do it differently?

Pilot #8: And different guys do it differently, yes.

Pilot #3: That will start to improve once we combine the sensors, once you start combining data, if I can have all my threat and all my radar and some other things superimposed I do not need a screen for each. So, you know a combination will do so slightly but I think there will still be some, mostly mission dependent but also be slightly personal dependent.

Pilot #4: Another big issue is getting all this information we are talking about and getting that in the cockpit. Probably most of that isn't going to come from my airplane. I will get a lot of it coming from my jet. But when you are really talking big pictures far away with a lot of detail you are probably talking information coming from other places that is being fed to me over a data link, probably, and if so you got to make this stuff work. You got to have that kind of foundation built in and right now we just don't have that. I don't know if anybody has that. But to put all that information at my disposal its got to be real time, its got to be accurate, and once I get that I would like to be able to manipulate it to suit me to optimize it.

Col Lyons: You were talking about crew formation, or teaming. Of course it is easier when you are all in the same airplane because you can talk together. You all have the same displays. But if you talk about guys in different airframes, separated from each other, all they have is the verbal communication.

Pilot #5: Well that's the part when he is talking about the data link.

Col Lyons: If you had a common display. If the guy in the tanker had a common display, not necessarily the identical display, but if he had access to the same information that you had access to then you would have a basis for a common understanding.

Pilot #4: Exactly that. We share within our four-ship of F-15s. We share information. I may lock a guy up with my radar and I give that information to the three other guys in that flight because visually I do not want to have to tell them because there are times that you can not talk fast enough and you can't hear it and process it. But if you see it the old picture is worth a thousand words it really is true. If you can visually depict it to you, that is a thousand times better than listening to somebody telling you about it over the radio. It is all forward coming to me and its what I see and it is what the guys in my flight and it is guys in the strike package, what everybody is seeing. All of that stuff and

disseminated back to everybody else. If you could, you would probably need to filter some of it because everybody would need to care about the same stuff. But from a technological point of view, you could do that. You could give that important information but it has to be right now, real time, and highly accurate because if you give bad information that's worse than not telling me anything. If you are getting bad stuff, and then if I am going to rely on that I am going to make a mistake and I don't want bad information I want real time and accurate.

Lt Col Yauch: The other issue that we have in the lab is not just presenting the type of a cognitive workload producing it delivering it to you in an intuitive way that you don't have to think about it. Can you guys talk about that a little bit, including primary task of maintaining aircraft control through all of the decision making that is going on when you analyzing new data.

Pilot #1: One of the big things that I have seen in the last couple of years is in order to take all this information the last two things that we talked about what we need is a central pot of information inside the weapon system and ways to draw that information out based on personal preferences, based on scenarios, based on threat prioritization, based on hundreds of different inputs I can draw that information out. Now how do you present it! You start looking at all the different human factors: colors, shape, size, movement, and all the other things that pilot interaction with the displays just for generic term. How are you going to present that! Right now we are kind of limited to technology in the present room we are the information integration. We can take all these different pieces of information and we integrate it, act on it, and in my case miss it half the time. That is something that technology can take care of. Take all the available information as opposed to presenting all the available information and let me figure it out. Collect all the information and present it based upon all these different hard inputs. Presenting in such a fashion is the easiest way for a human to discern, based on shape, color, size, movement, and physical location in the cockpit. Is it in his face, is it on the canopy, is it holographic! What is the sanest way or most efficient way to this human factors-wise presenting all this?

Lt Col Yauch: O.K. We have a big disconnect because generally aviators don't want all that information until it is decluttered especially when they are in the mission phases trying to kill something in the ground or in the air. That you want the least information and really at that point you need to focus even if you are getting all that information you are not going to attend to it. So it is kind of a mixture.

Pilot #4: It depends on what phase of the mission you are in. But you know farther out when you are not channelized on one or two things I would like to see a lot of information that I could take in and process and decide which way is the best way to deal with this. Based on that make a decision, get my formation moving and working and now as the range closes whether you are a striker dropping bombs or air-to-air guy and you are looking to kill an enemy fighter or a seek guy looking for SAMs (surface-to-air missiles) to kill whatever. As you get to the point where you are about to do that you are going to channelize on that and a lot of that other stuff even if it is there you are probably not going to see it and you may not really need it. Even if you do need it you probably don't need it as bad as the thing you got to do right now. So it is a priority of how many things you got to do right now. So it is a priority of how many things you need to do.

Lt Col Yauch: How can you get your attention back? I mean you kind of turn this problem around that there is not any kind of solution to our problem. Getting your attention back when you are fixing like that cause you have something to do then it is a dynamic environment and things are changing. Now there is a new piece of information. Sometimes it might be that the ground is rushing up to meet you. That might be important information. But I am busy right now, please leave me alone. Or it might be another threat popping up or who knows what it might be. Or it could be the fuel level light. It could be internal to the cockpit or external to the cockpit. How do we get that attention back?

Pilot #6: Generally, orally is about the only way that you will be able to get back. Generally, visually you are fixated whether it's inside or outside to the point where the light over here you will never see. Short of something tapping you upside the head, that might get your attention but orally, some movement on you body so physically we use to have the old "knuckle-wrapper" in the aircraft when they are installed that got your attention to think we were serious. So even oral things can slip by unless volume and intensity in the right words are there.

Lt Col Yauch: First thing you do is go to all your light controls, punch it all....three quarters of them.

Pilot #6: Turn them down and turn them off if you think the threat on flight is more important than anything else that can happen right now it is going to be hard to get your attention but if you thing....physically or orally, visually....

Pilot #7: Well it could just be the primary sensory organ you are looking at a visual cue, a big X in a HUD or something like that, that might get your attention.

Pilot #6: Possibly, it depends on your mode of presentation, if it is something that you are already looking at and it drastically changes. But if it is still, once you get fixated, it would probably drastically have to change back to something you are specially talking about helmet mounted or something.

Col Lyons: Yes. You know that when they design educational programs on the computers it used to be that computers go through steps, but now, with a computer education has been developed. The computer understands the student. The computer interacts and begins to understand what is next in your mind and how to do things. So is it possible in the future that airplanes would not only understand the scenario where you are in the scenario where your mind is but actually understand how you like it and how you usually set things up?

Pilot #4: I am sure you can do that to a point but it is so dynamic that you very rarely, even after years of doing it and lots of hours doing it, from one mission to the next, it is not the same. There is a bazillion variables and they may be close to this mission to the last mission or they could be totally different but it wouldn't look anything the same. So I am sure you can do what you just talked about to some point but...

Pilot #6: One variable that is tough to control is weather. You can not always predict what the threat is going to do or how he will engage you. So there is a variable that you can probably with computers now a days put in a lot of variables with how the threat controlled by a human will react and secondly one you will have a hard time getting your arms around in going to be weather. Because that affects how we act and react that is something generally we get real time. So those will be the two variables I think that even computers with lots of inputs could not handle.

Pilot #4: I think you will get a lot of resistance from guys who fly to taking the decision making away from them and trying to automate it. It's almost the point that I would rather make a bad decision, but it is mine, than have a computer do it for me.

Col Lyons: I wasn't thinking about automating the decision but to automate what it tried to show you. So it doesn't bother you about the fuel until a certain point and then it tries to bother you. So that the system has an idea of what is trying to tell you.

Pilot #6: I would say that with large errors that is possible: ground avoidance, fuel, and emergencies with the aircraft we get a lot of that now, really.

Col Lyons: Well I mean even in terms of tactical or strategic information the machine may understand what types of things generally the situation would be interested in and what types of things you are not generally interested in the situation.

Pilot #4: I would think there would be a system that you can program before you walk out to the airplane and tell it that you want it to do certain things. So you have the input to the program itself telling the computer this is what I want you to start telling me about this is what I want you to do this. This is when I want you to do this and walk in there, out there and plug it into the airplane versus just having one already in the airplane which is standard throughout.

Dr. Grant McMillan: Do you think you could do that in advance for most situations? No, because if you could if you think that kind of aid could be preprogrammed by you guys that would ease our jobs in designing those kind of systems a whole lot rather than us trying to guess on the fly.

Pilot #6: I would say some missions you could do that for and some are more complex than others.

Pilot #4: It is real time. Like fuel, I got a little bingo bug I could set at 6000 pounds and it goes off and says Bingo. O.K., that is really joking. I move it down to four the next time it goes off I know I am done and I can get out of there and go home. But I set it. I guess it could know how far I needed to go home and what my fuel consumption would be and all that. It could help clue me in but I have already figured that out and do it now.

Col Linder: I mean if it could be tailored during a conflict it could be much faster than if we...

Pilot #6: If we were going to go to a system like that where authorities set in the computer that it was going to do different things at different times I would much rather have the input myself than have somebody that is not flying my airplane make those kind of decisions.

Dr. Grant McMillan: Did you mention WSO (Weapon Systems Officer)? Did I hear....?

Because I have often thought that we in the laboratories should be thinking a whole lot more about a backseater or a WSO as our model than we should be thinking about nutral nets and learning systems. In other words we want a system that will help the pilot out and we often base that on thinking about what backseaters and WSOs do but then we often hand it over to some computer scientists you know who knows nothing about the nature of the interaction, nothing about the trust, nothing about the interaction that has developed over time. I mean am I thinking crazy about that? Just having said that doesn't mean that I know how to do that. I often thought that we have used the wrong model when we talk about aiding systems.

Pilot #8: Whenever we have a ground based system that interfaces with the jet, they tend to develop disconnects. The jet tends to lead the way and the ground based system tends to fall out. No matter how well intended you are that the whole runs side by side but ever time you modify the jet. So if you start getting off to where the ground does too much, you are going to lose because the jet is going to walk away from the ground based system. Anytime you go we are talking about tailoring the jet's capabilities you have to interface whatever mission plan tool that you are using. But the problem is every.....

Lt Col Yauch: Mission reverse is going to the simulator....throughout that you can actually have a little program resaved here I want you to give me this information at this time you program that all up, but then it falls behind in technology....

Pilot #8: But if you look at all simulators they tend to lag the real airplane. If you look at all the mission planning tools that we have available to us now they tend to lag. I mean they are up to date when you first introduce it but that is about the last time you really see them ever. So that is the disadvantage of trying to do that and I have never seen it run parallel so I can't expect it in the future.

Pilot #9: What you are saying about the ground systems lagging the airplanes, where there is a limited amount of money and the airplane will generally be upgraded and the ground based system lags a lot times because there is not enough money to fund it and keep it up to speed.

Col Lyons: Maybe we should move to the more tactical or closer image.

Dr. John Firth: Let's get back to actual aircraft handling the F-15, F-16, and so on and wait to you see the limitations there. How would you take out Fred if you met him up the desert somewhere and so on. Where do you see the present constraints? Where should we be looking beyond that?

Lt Col Yauch: What we are really looking at is human limitations in flight and when we go to supermaneuverability how the human limitations that exist now, how that human limitation can be expanded, or modify the cockpit can be modified to take that in account?

Dr. John Firth: Let me put this in practical terms. We lost two Tornados that other day. As a British taxpayer I am outraged. Why am I outraged? Because the escape window was to push a little negative (Gz) that's all he had to do, but no, he pulls and pulls and he pulls straight into two Tornados. Luckily we had four aircrew out of it and all four will fly again. But there is a lot of rubbish scattered all over Lincolnshire. Now you chaps never fly negative (Gz), why? These characters have made your aircraft that have +12 Gz, -12 Gz, +15, -15, but you never go minus. Would you like more +G? Or do you want +11, +12, +13, +14, +15?

Col Lyons: Or do you want what the X-31 does or what do you see now is the advantage?

Pilot #4: Right now, if you take Eagles (F-15) and F-16s and you make them turn, you have to put gigantic motors on them so they can sustain that. And you give me COMBAT EDGE (G protection ensemble) or ATAGS (G protection ensemble) so I don't kill myself with that capability, we are already physically limited in the airframe envelope. In order for me to shoot a guy, I got to point at him. In order to point at him you have to have big ass motors so I can pull 12 Gz and hope it doesn't kill me in the process. So what do we do? We build a helmet mounted display so that now I can look and shoot. That takes a whole ton of money. The next step would be an airplane like the X-31 doesn't have to have big motors, or pull 12 Gs, its designed to fly out of control under control and you can flop it around and point it at guys, 6-7 Gs, whatever, and now you can point and shoot.

Dr. Grant McMillan: Why do you need to point if you have the helmet mounted sight?

Pilot #4: You actually wouldn't there. The next ting would be to have an airplane that points real good with a helmet that helps you point even better.

Dr. Grant McMillan: That's true it gives you a bigger envelope.

Pilot #8: That's the advantage if you're wearing that bucket on top of your head and you're going to 12 Gs your neck is going to have to be about that big (gesturing).

Pilot #6: The ideal visual merge for me would be an X-31 and a helmet mounted sight and a capability that if I want to egress I don't want it to take 30 seconds to get back up to speed from 180 knots. I want something that I can get going fast in a hurry.

Pilot #7: That seems to be a tradeoff with the X-31. That is the speed loss with the maneuvering. If you are in close and slow that's O.K., but you need to get back up to speed.

Mr. Fred Knox: The X-31 does not change any of those rules.

Pilot: If you combine the X-31 with a helmet mounted system, your ability to get that first launch against an adversary even before he gets his missile off the rails, that's what we've been testing. It's not that you get the first launch, but that you get an impact on his aircraft before he gets his off the rails.

Mr. Fred Knox: Yes, I agree. Let me give you a simple strategy. We basically started a merge and at the pass the strategy was real simple, "let's try to stay inside minimum range for AIM-9 (air-to-air missile) or missile he was carrying; if we were inside minimum range there was no way the guy was going to gun us. And we were going to probably have a gun on him. So the survival was a simple experiment and the outcome was we never went outside that minimum range for AIM-9L or missile."

Pilot #4: O.K., what we have been seeing is we're flying with a helmet mounted system that lets you look high off boresight (OBS) with a missile that looks high off boresight (OBS) and be employed against a threat that also has a helmet mounted display and a missile with a OBS of 60°, well in order to do a merge and turn and kill him, you now find him, lock him, and shoot him and my missile kills him before he can shoot one back. We then, it's not 60°, O.K., mine's out of 80°, mine's not big enough because I can maybe shoot first but if he can shoot me back, I'll die second. That's not going to do me much good.

Col Lyons: A helmet mounted sight (HMS) if offensive capability, only. It seems to me if everyone has a HMS...

Pilot #6: No, no, no, it's defensive also. You can display a lot of different things on the HMS. I don't like all that crap up there all the time. Case in point, when we flew with our previous helmet and you looked in the cockpit, you have all this helmet symbology superimposed over the radar scope. I don't need to see that. I would toggle off the helmet until I got to a visual arena then I would turn it on to slave my radar or queue a missile. So I never even used the thing outside of 10 miles because it was just a pain. Well now it's maxed so that if I look, I look below the canopy rail into the cockpit. I can now personalize it so it turns itself off and now I don't have that distracting symbology down there bugging me. Now, on the new helmet the system knows when we are looking inside the cockpit and it masks the symbology. Now, if I was locked, I could look over at my adversary and have a container, just like with the radar, and a RWR (radar warning receiver) target designator box so that I could visually acquire that guy. That's an example of a defensive application for a HMS. HMS are most offensive.

Pilot: It's also counteroffensive when you're "in the notch." I can shoot someone in the notch.

Col Lyons: The notch means what?

Pilot: I'm 90° out from his radar beam. I can look over now, even though I'm 90° off, and still shoot him. It's not offensive or defensive, its counteroffensive.

Pilot: The situation he was just talking about, if someone locks me up, I can look through the helmet and see the RWR, the airplane says this is where he is locking you, or I have a missile launch detector on the aircraft, it cues the helmet. I can look over there and visually acquire the missile, especially SAMs (surface-to-air missiles). I was talking to some guys who flew in the (Gulf) war and especially SAMs which is one of the bigger, more important steps in the defeating the SAM is seeing the SAM, and to be able to time the appropriate maneuvers, or countermeasures, or whatever. If you can cue my eyes somehow to tell me exactly where to lock to visually acquire whatever that's a defensive application of the HMS.

Col Lyons: That old way is you hear a tone, you look down on the scope, that tells you where to look. All that takes a long time.

Pilot #4: It tells you in 2 dimensions. The current scope gives you azimuth and a WAG (guess) at the range. I got no elevation cue. But with the HMS I would know where to look in azimuth and elevation and the range would probably be the same as it is now.

Dr. John Firth: How useful would be agility in avoiding a missile?

Pilot: Let's look at your list. Let's start with thrust. There is no such thing as enough. As long as I can control from zero to maximum, you cannot put me enough thrust on my aircraft. If I can go from zero to Mach 8 in a blink of an eye, it is something that would have to be dealt with physiologically, O.K., but if I can get out of here, now. Speed, same thing, it has a big effect too, every pilot in this room is used to fighting at tactical airspeeds, we're use to fighting at 400-500-600 knots you know 1 mile/min or 2 miles/min closing rates, whatever. The question is, how fast can I go around the circle and how big is the circle? Gs are the limiting factor inside the circle. I don't want a 12 G aircraft. The difference is do you want to do a 360 degrees/sec rate fight at 12 Gs?

Pilot: No, you wouldn't do that, but it would give you the capability of hitting the merge at 500 knots to instantaneously.

Pilot: I would disagree with you. If I hit the merge at 500 knots, give me the capability to decelerate to 150 knots. Then do a 180° in yaw in 0-5 seconds and then accelerate back in the other direction.

Pilot #4: You're absolutely right if you're flying your Viper (F-16) and I'm flying my Eagle (F-15), but if you're talking about an aircraft with thrust vectoring that can do 7 or 8 Gs at 200 knots...

Pilot: True, if you're at 200 you still need to get to 200 and I have never found myself in a situation, airborne, where I've felt the aircraft is outperforming what I want it to do. A lot of it is the slow speed thrust vectoring. I can't get my nose there, but the other side of it is a system in the aircraft to protect the pilot if I want 12 Gs right now, I can go 12 Gs right now and I'm not limited to 9 Gs.

Dr. John Firth: So there we have the agility and speed to slam on the brakes and stop, not necessarily aerodynamically, but that's the option to that. The second option is the maneuverability, not having to do the turn aerodynamically. If you have to do that you have a long turn with very high Gs. If you can slam on the brakes and turn around, like doing a braked turn in a motor car....

Pilot: I think we're looking at applications versus what it is we're trying to do. The question is we want to point our nose from here to there in the shortest amount of time possible...Now how do we do that?

Pilot: With the least airspeed loss.

Pilot: On the ability to go 180° with negligible loss in airspeed and no increase in G...it's almost impossible!

Researcher: One possibility is to rotate the pilot in the cockpit to get G_x rather than G_z.

Pilot: Talk about spatial disorientation...that would take a lot of getting use to!

Researcher: With supermaneuvers, though, you're not always traveling in the same direction you're sitting facing, so what if we rotated the seat so that you are always facing the velocity vector? Would that help?

Pilot #4: No! That is the opposite of what I want to do. If I pass the guy and he goes by, and I turn this way, if the seat if turned any way, I would want it to rotate into the turn so that I am looking over the back end of the airplane at the guy rather than...

Researcher: So if you would rotate the seat you would want to be able to face your threat not the direction traveled?

Pilot: (Laughter) I think we'd have to try that. I don't think anybody could...

Col Linder: You may be able to make some flat turns....

Pilot #4: Yea, like on a skid.

Researcher: Have the seat slaved to the helmet.

Pilot #4: I would probably automatically eject! (Laughter) That's a radical concept!

Col Lyons: Have any of you (pilots) had a mismatch between COMBAT EDGE and the helmet mounted display?

Pilot: We have not flown the HMS with COMBAT EDGE, yet.

Pilot #4: I think the HMS thing is going to be a tough nut to crack, because it has to be very accurate to be useful. So when the helmet doesn't fit just right and you lay the Gs on, the helmet rotates you lose the display, so now you're trying to fly and you're holding onto you helmet and fix it and....

Col Lyons: But those are actually technical problems. So there are two issues: One, what do we want? And two, technical feedback to solve these problems.

[Col Lyons hands out his questionnaire and explains]

Dr. Grant McMillan: If you're talking about the low speed maneuverability of the X-31, does that help you in terms of missile evasion? Or do you have to be doing that kind of stuff at high speed? Let's say you have gotten off a shot, but he has too. Does agility help you in that situation?

Pilot: If I am dodging a weapon, kinematically, I need to think about I need to do. I need to move away from their piece of that airspace to that piece of airspace in the fastest way possible.

Dr. Grant McMillan: Right, so having good yaw pointing doesn't help?

Pilot: If the missile has time to adjust, combined with a fairly large warhead, you need some fairly aggressive maneuvers both in 3-D and to move away from that spot.

Dr. Grant McMillan: So, the maneuvering can help you but you still need big engines to move you away from that spot.

Mr. Fred Knox: *[Long discussion about how Knox engaged bogies in the X-31]*

Col Linder: I have a question about training in superagile fighters. How do you achieve all of these skills? Simulators? Basic training?

Pilot: When I started flying the F-15 we had AIM 9Ps and AIM 7Fs, now we have VCATS, AMRAAMS, and new JTIDS; I don't think it is any more difficult. Now it is less a struggle for information but trying to manage that information is a struggle. 25 years from now what we're talking about is a completely whole new set of parameters?

Col Linder: How about cost?

Pilot: If the airspace is bigger we'll have to train more.

Col Lyons: How many hours a year are you guys flying?

Pilot: Not enough. (Laughter)

Pilot: Operationally, fighter pilots are getting about 300 hrs/year. We, here at Nellis, average about 200 hrs/year (F-15). F-16s about 250 hrs/year.

Lt Col Yauch (to Fred Knox): Regarding the simulation issue. I got the impression from you that the X-31 flight simulator was so different from actual flight that it was next to worthless.

Mr. Fred Knox: Remember we were using the simulator for different reasons. In my operational days I hated the simulator. It did reduce the number of engagements we had to do (in the X-31s) for real, we could set up initial starting

conditions and rehearse all of those things. We came up with some initial tactics development, and we could do some safety development, too. The guys who flew the sims (simulators) were more up to speed.

Pilot: I think they're good for a long-range sensor integration and data management are the biggest advantages of the sim (simulator). But over you get into close in air-to-air, they are not good yet.

[MsMillan posed a question about increased workload with HOTAS, hands on throttle and stick, and the need for attending to other things. The pilots equated HOTAS and doing additional things to play the flute or piano. As you get more experienced it comes naturally. Fred Knox: once you've flown one yet, most of it transfers to the new jet.]

[Col Lyons led a long discussion on F-15/F-16 training and training proficiency. The pilots said they need to fly 2 to 3 times a weeks, 1-1/2 hrs each, 20 hrs/month to stay proficient. An experienced pilot could fly less and stay proficient. I would think you could fly high Gs once a week and keep your G tolerance up, one pilot said.]

Col Linder: We (Sweden) fly less than 200 hrs/year, but we fly 3 sorties/week.

END OF TAPE

Mark STUCKY
NASA/Dryden Flight Research Center
P.O. Box 273
M/S 1029
Edwards CA 93523
United States

Transcript of audio tape

INTRODUCTION

Mark “Forger” Stucky was a research/test pilot at the NASA Dryden Flight Research Center. Stucky’s background included fourteen years of active duty with the U.S. Marines where he initially flew F-4 Phantoms and subsequently F/A-18 Hornets. He joined Dryden in 1996 and initially served as the last project pilot on the F-18 High Alpha Research Vehicle (HARV).

Stucky’s comments on the F-18 HARV:

I was honored to have about seven flights in the F-18 HARV before the program ended. The HARV was really the first high alpha thrust-vectoring (T-V) aircraft and laid the groundwork that the X-31 built upon. The HARV is essentially an F-18 that has been modified by removing the conventional convergent/divergent axisymmetric exhaust nozzles on each engine and replacing them with 3 moveable paddles (vanes) per engine. This T-V configuration was externally similar to that of the X-31 although the HARV had two engines. The vanes are actuated by the flight control computers to provide 3-dimensional thrust vectoring within the approved thrust vectoring envelope (medium to slow airspeeds and above 15,000 ft. MSL). In later stages the HARV was also configured with individually activated nose strakes which provided additional maneuvering capabilities at high angles-of-attack (AOA). When the T-V mode was engaged, the pilot provided control inputs using the conventional stick.

The F-18 has good thrust-to-weight (T/W) but noticeably less than some other fourth generation fighters. High T/W is important for any fighter, the importance of which increases with increasing capability for high AOA maneuvering. The F-18 has a reputation for being able to dogfight extraordinarily well but once it engages it is in the fight until either it or the opponent dies – trying to disengage or “bugout” of a fight is extremely risky in an F-18. It’s my opinion that adding T-V to any aircraft increases it’s T/W requirement because now the pilot will want to exploit the T-V capability.

A pilot can sustain approximately 55° AOA in a standard F-18. At such extreme angles-of-attack the aircraft can still be maneuvered in roll, albeit at a sluggish rate. The HARV can sustain 70° alpha while maintaining impressive roll rates. The HARV suffers from even less T/W than the stock F-18 because the nozzles are not as efficient, weigh more, and require additional weight in the nose to keep the center of gravity within limits. So when the HARV is performing its outstanding nose pointing capability at extreme AOAs, it is also losing altitude at a fast rate.

HUMAN FACTORS ISSUES

In thinking about the physiological issues you all are interested in my first comment is that until the F-15 ACTIVE came along, all the T-V I know of was done at low airspeeds and high angles-of-attack, regions that don’t have much G loading on the pilot. The G forces are not much different than sitting in a swivel chair and having someone point the chair in different directions -- it’s relatively benign. In my first flight in the HARV, I was surprised by how bizarre it felt. It felt extremely unnatural, but it was very predictable and therefor easy to learn. Instantly, I felt “this is bizarre, but I know what to do to point the nose with almost reckless abandon!” It is a great first impression, that you have a capability that is so different from anything else you’ve experienced but that you can use it so well immediately.

Even if aircraft have the capability to perform T-V at higher speeds and low angles-of-attack, that doesn't mean the physiological stresses will be too different on the aircrew. Unlike racing cars that can pull several lateral G's on corners, current tactical aircraft simply are not structurally stressed for such capabilities. Typically, vertical tail load is the limiting factor.

As I mentioned previously, with the HARV modification, we lost some propulsive efficiency so during the T-V maneuvers, regardless of where the nose was pointed, we were really going downhill fast. The HARV T-V disengaged automatically below 15,000 feet so we never flew down low like the X-31. One thing that we need to be cautious of for future generations of F-22 pilots is this new ability to put themselves in an extremely high drag situation where the nose is pointed up but the aircraft is losing altitude rapidly. In such situations it could be difficult to judge when to need to knock it off and accelerate out of the maneuver prior to hitting the ground. I think it is a lot like jumping out of an airplane. In free fall, until the last couple of thousand feet you don't have any sensation that you're coming down fast. I think with T-V it is tougher to judge rates of descent because the nose is not in the conventional nose-low attitude. With the aircraft's nose pointed way up but the aircraft's velocity vector pointing below the horizon, all the current cues on the Head's Up Display (HUD) will be of negligible use.

We need to remember also that extreme maneuvering is done to place your opponent's aircraft within a weapons solution. Until that occurs the opposing aircraft is typically well outside the HUD field-of-view limits. Since fighter pilots have to keep their eyes on their opponent it is easy to miss HUD cues during dogfighting. I expect we will see future helmet mounted displays providing cueing to include actual flight path orientation as well as ground proximity warnings.

I was saying that I think that an F-15 ACTIVE pilot might be good to talk to because they are doing high-speed thrust vectoring although I don't think they are doing maneuvers that expose themselves to unusual sustained forces. I have had one flight in the ACTIVE and did not notice any unusual sensations during the T-V. At high speeds and low angles-of-attack the T-V gives additional capability but it feels conventional to the pilot.

Q. You told us that you can have an AOA at 50° and a flight path angle of -35° . Do you have a scientific presentation of information of your position in space. Like an arrow presentation of what you are doing?

A. No, we did not have any special display. The only addition to what I call a standard heads-up display arrangement, was we had a flight test display for side-slip. The HARV could generate tremendous yaw rates, rates that would cause a standard Hornet to enter spin recovery mode. This was turned off in the HARV but we had a "spin recovery" cue in the HUD to let us know that we were at an AOA and yaw rate that would cause a normal F-18 to enter spin recovery mode. This was the region where we normally did our flying. We were not overly concerned with HUD cueing because it was research flying and we automatically exited T-V at 15,000 ft. MSL. It thinks better pilot cueing will need to be addressed before T-V becomes standard on operational fighters.

Q. Did you experience the disengagement as a surprise? That's one question and the other one, have you done it in bad weather conditions?

A. No, to both. For most of these tests, we were doing planned maneuvers at planned conditions so we monitored our altitude closely. Therefore we always knew when we were getting close to an automatic disengagement. An impending disengagement didn't stop us, we tried to complete as much as possible prior to the auto disengagement. The disengagement was essentially a non-event – it kicks you out, then you have to recover. I guess you do not want to necessarily be at a maximum yaw rate and angle of attack at disengagement but we did not place additional aside from common sense limits on us.

No, all of the HARV research flying was done in day VMC conditions. This particular aircraft did not have any navigational aids for weather or IMC flying.

Q. How would you predict problems with a bad horizon?

A. I think that bad weather compounds things because your body is undergoing accelerations that are very unique. Without any external visual cues I would say you would really increase your chances of vertigo, disorientation, and motion sickness.

Q. Do you experience side slip/side forces, the X-31 has no side slip really.

A. Yes, in the HARV you experienced a bunch, but you are at relatively slow speeds, and what you experienced is side forces that are not really strong, but are sustained. You know that you are skidding around a turn, and it's very unnatural, but you can stop it wherever you want, you can point the aircraft wherever you desire. We do a maneuver where you came in with some lateral separation against a target. The target would do its best turn around and we would do an almost flat spin around to get it in our gun sight. So you're just skidding around sideways, not too different than a car on ice. But the difference is that you can stop it instantly whenever you want. It feels very unnatural, but very controllable. But at these speeds it's not like you're doing 2 lateral Gs, it is a noticeable uncoordinated turn for an extended period of time.

Q. Were you making that yaw maneuver on rudder? Did you have rudder authority?

A. No, the yaw maneuvers were accomplished using lateral stick. The rudder is automatically faded out by the flight control computers at high angles-of-attack so rudder authority really isn't the point. What method you use to command the maneuver is a good topic of debate. In most of these T-V situations you're doing these strange velocity vector rolls. It's all done with the lateral stick and you can leave your feet flat on the floor. It isn't necessarily intuitive but you can instantly see what the stick does and you quickly learn how to do it.

For some reason, there seems to be a kind of growing feeling that if you don't have to use your feet, it's a good airplane. When you flew the original non-slatted version of the F-4 you had to coordinate turns with rudder at higher angles of attack. At high AOA's you could not use lateral stick at all to turn, you had to just use rudders or else you would depart controlled flight in the opposite direction. So it's become kind of a mark of a great airplane if you can design it to be carefree so the pilot doesn't have to worry about using the rudders. I think that we have gone a little bit too far in that direction because I think there are situations where using the rudder pedals could be more intuitive. As an example, if you're doing a flat turn it would make more sense to me to use a rudder pedal. There's nothing wrong with having to use your feet to make the nose move laterally and I would rather see lateral stick be used for rolling. I think there will be a lot of discussion over these issues as T-V technology matures.

Q. So you think it's intuitive to use the stick for pitch and roll and the rudder for yaw?

A. Yes. That is the way it is initially learned from your first flight in conventional trainer aircraft.

We need to decide how to blend in thrust vectoring at high and low angles-of-attack. How do you progressively do that? You might just need a new controller. Like on the Space Shuttle, when they are controlling in space they use an additional "joy stick" controller which they can use to push down and pull up to translate vertically. Additionally, they can rotate the control stick and that can very well make sense for commanding side slip. You could use the rudder pedals for the rudder only and use the rotational stick input to command T-V.

This page has been deliberately left blank



Page intentionnellement blanche

REPORT DOCUMENTATION PAGE

1. Recipient's Reference	2. Originator's References RTO-TR-015 AC/323(HFM-015)TP/15	3. Further Reference ISBN 92-837-1065-7	4. Security Classification of Document UNCLASSIFIED/ UNLIMITED
5. Originator Research and Technology Organization North Atlantic Treaty Organization BP 25, 7 rue Ancelle, F-92201 Neuilly-sur-Seine Cedex, France			
6. Title Human Consequences of Agile Aircraft			
7. Presented at/sponsored by the RTO Human Factors and Medicine Panel (HFM).			
8. Author(s)/Editor(s) Multiple			9. Date May 2001
10. Author's/Editor's Address Multiple			11. Pages 186
12. Distribution Statement There are no restrictions on the distribution of this document. Information about the availability of this and other RTO unclassified publications is given on the back cover.			
13. Keywords/Descriptors			
Fighter aircraft Aerodynamic characteristics Human factors engineering Maneuverability Flight maneuvers Situational awareness Stress (physiology)	Stress (psychology) Thrust vector control Flight simulation Pilots (personnel) Pilot training Simulation Personnel selection	Ejection Acceleration tolerance Flight control Agility Angle of attack PVI (Pilot Vector Interface)	
14. Abstract			
<p>While historically agile flight was first seen as an issue of airframe agility with a consequent emphasis on acceleration issues, there has been an evolution in the understanding of agility. WG 27 adopted WG 19's recommendations that airframe agility is only one aspect of agility which when combined with weapons agility and systems agility results in "operational agility." The experienced pilots that we interviewed saw a real operational need for agile aircraft. They consistently rated both high angle-of-attack/nose pointing and off-boresight missiles/helmet-mounted display/sight systems as very important capabilities. They denied physiologic problems related to acceleration or spatial disorientation, although their sorties to date have been with a clear sky, in active control. Experts predict an increase in both G-LOC and spatial disorientation mishaps in future agile aircraft. In particular, there are significant gaps in our understanding of the effects of multi-axis accelerations. With minimal constraints on angle-of-attack and expanded weapon launch envelopes, novel displays will be required that enable pilots to fly with references well beyond conventional fields-of-view. Intelligent interfaces, and automated subsystems will be required to help pilots cope with the tactical situation, while also maintaining situational awareness. Efficient controls are also needed to enable pilots to command and operate equipment quickly and accurately. The thrust-vectoring and post-stall operations should be fully integrated into the flight control system. Pilots still prefer controlling aircraft functions via HOTAS (hands-on-throttle-and-stick) although voice and gaze-based control may also be useful. Current pilot protection systems will be inadequate in an unconstrained flight envelope and during ejection. Both basic and applied research will be needed to ensure that the potential benefits of increased agility are realised.</p>			

This page has been deliberately left blank



Page intentionnellement blanche



RESEARCH AND TECHNOLOGY ORGANIZATION

BP 25 • 7 RUE ANCELLE

F-92201 NEUILLY-SUR-SEINE CEDEX • FRANCE

Télécopie 0(1)55.61.22.99 • E-mail mailbox@rta.nato.int

DIFFUSION DES PUBLICATIONS

RTO NON CLASSIFIEES

L'Organisation pour la recherche et la technologie de l'OTAN (RTO), détient un stock limité de certaines de ses publications récentes, ainsi que de celles de l'ancien AGARD (Groupe consultatif pour la recherche et les réalisations aérospatiales de l'OTAN). Celles-ci pourront éventuellement être obtenues sous forme de copie papier. Pour de plus amples renseignements concernant l'achat de ces ouvrages, adressez-vous par lettre ou par télécopie à l'adresse indiquée ci-dessus. Veuillez ne pas téléphoner.

Des exemplaires supplémentaires peuvent parfois être obtenus auprès des centres nationaux de distribution indiqués ci-dessous. Si vous souhaitez recevoir toutes les publications de la RTO, ou simplement celles qui concernent certains Panels, vous pouvez demander d'être inclus sur la liste d'envoi de l'un de ces centres.

Les publications de la RTO et de l'AGARD sont en vente auprès des agences de vente indiquées ci-dessous, sous forme de photocopie ou de microfiche. Certains originaux peuvent également être obtenus auprès de CASI.

CENTRES DE DIFFUSION NATIONAUX

ALLEMAGNE

Streitkräfteamt / Abteilung III
Fachinformationszentrum der
Bundeswehr, (FIZBw)
Friedrich-Ebert-Allee 34
D-53113 Bonn

BELGIQUE

Coordinateur RTO - VSL/RTO
Etat-Major de la Force Aérienne
Quartier Reine Elisabeth
Rue d'Evère, B-1140 Bruxelles

CANADA

Services d'information scientifique
pour la défense (SISD)
R et D pour la défense Canada
Ministère de la Défense nationale
Ottawa, Ontario K1A 0K2

DANEMARK

Danish Defence Research Establishment
Ryvangs Allé 1, P.O. Box 2715
DK-2100 Copenhagen Ø

ESPAGNE

INTA (RTO/AGARD Publications)
Carretera de Torrejón a Ajalvir, Pk.4
28850 Torrejón de Ardoz - Madrid

ETATS-UNIS

NASA Center for AeroSpace
Information (CASI)
Parkway Center
7121 Standard Drive
Hanover, MD 21076-1320

FRANCE

O.N.E.R.A. (ISP)
29, Avenue de la Division Leclerc
BP 72, 92322 Châtillon Cedex

GRECE (Correspondant)

Hellenic Ministry of National
Defence
Defence Industry Research &
Technology General Directorate
Technological R&D Directorate
D.Soutsou 40, GR-11521, Athens

HONGRIE

Department for Scientific
Analysis
Institute of Military Technology
Ministry of Defence
H-1525 Budapest P O Box 26

ISLANDE

Director of Aviation
c/o Flugrad
Reykjavik

ITALIE

Centro di Documentazione
Tecnico-Scientifica della Difesa
Via XX Settembre 123a
00187 Roma

LUXEMBOURG

Voir Belgique

NORVEGE

Norwegian Defence Research
Establishment
Attn: Biblioteket
P.O. Box 25, NO-2007 Kjeller

PAYS-BAS

NDRCC
DGM/DWOO
P.O. Box 20701
2500 ES Den Haag

POLOGNE

Chief of International Cooperation
Division
Research & Development Department
218 Niepodleglosci Av.
00-911 Warsaw

PORTUGAL

Estado Maior da Força Aérea
SDFA - Centro de Documentação
Alfragide
P-2720 Amadora

REPUBLIQUE TCHEQUE

Distribuční a informační středisko R&T
VTÚL a PVO Praha
Mladoboleslavská ul.
197 06 Praha 9-Kbely AFB

ROYAUME-UNI

Defence Research Information Centre
Kentigern House
65 Brown Street
Glasgow G2 8EX

TURQUIE

Millî Savunma Başkanlığı (MSB)
ARGE Dairesi Başkanlığı (MSB)
06650 Bakanlıklar - Ankara

AGENCES DE VENTE

NASA Center for AeroSpace
Information (CASI)

Parkway Center
7121 Standard Drive
Hanover, MD 21076-1320
Etats-Unis

The British Library Document
Supply Centre

Boston Spa, Wetherby
West Yorkshire LS23 7BQ
Royaume-Uni

Canada Institute for Scientific and
Technical Information (CISTI)

National Research Council
Document Delivery
Montreal Road, Building M-55
Ottawa K1A 0S2, Canada

Les demandes de documents RTO ou AGARD doivent comporter la dénomination "RTO" ou "AGARD" selon le cas, suivie du numéro de série (par exemple AGARD-AG-315). Des informations analogues, telles que le titre et la date de publication sont souhaitables. Des références bibliographiques complètes ainsi que des résumés des publications RTO et AGARD figurent dans les journaux suivants:

Scientific and Technical Aerospace Reports (STAR)

STAR peut être consulté en ligne au localisateur de
ressources uniformes (URL) suivant:

<http://www.sti.nasa.gov/Pubs/star/Star.html>

STAR est édité par CASI dans le cadre du programme

NASA d'information scientifique et technique (STI)

STI Program Office, MS 157A

NASA Langley Research Center

Hampton, Virginia 23681-0001

Etats-Unis

Government Reports Announcements & Index (GRA&I)

publié par le National Technical Information Service
Springfield

Virginia 2216

Etats-Unis

(accessible également en mode interactif dans la base de
données bibliographiques en ligne du NTIS, et sur CD-ROM)



Imprimé par St-Joseph Ottawa/Hull
(Membre de la Corporation St-Joseph)

45, boul. Sacré-Cœur, Hull (Québec), Canada J8X 1C6



RESEARCH AND TECHNOLOGY ORGANIZATION

BP 25 • 7 RUE ANCELLE

F-92201 NEUILLY-SUR-SEINE CEDEX • FRANCE

Telefax 0(1)55.61.22.99 • E-mail mailbox@rta.nato.int

DISTRIBUTION OF UNCLASSIFIED

RTO PUBLICATIONS

NATO's Research and Technology Organization (RTO) holds limited quantities of some of its recent publications and those of the former AGARD (Advisory Group for Aerospace Research & Development of NATO), and these may be available for purchase in hard copy form. For more information, write or send a telefax to the address given above. **Please do not telephone.**

Further copies are sometimes available from the National Distribution Centres listed below. If you wish to receive all RTO publications, or just those relating to one or more specific RTO Panels, they may be willing to include you (or your organisation) in their distribution.

RTO and AGARD publications may be purchased from the Sales Agencies listed below, in photocopy or microfiche form. Original copies of some publications may be available from CASI.

NATIONAL DISTRIBUTION CENTRES

BELGIUM

Coordinateur RTO - VSL/RTO
Etat-Major de la Force Aérienne
Quartier Reine Elisabeth
Rue d'Evère, B-1140 Bruxelles

CANADA

Defence Scientific Information
Services (DSIS)
Defence R&D Canada
Department of National Defence
Ottawa, Ontario K1A 0K2

CZECH REPUBLIC

Distribuční a informační středisko R&T
VTÚL a PVO Praha
Mladoboleslavská ul.
197 06 Praha 9-Kbely AFB

DENMARK

Danish Defence Research
Establishment
Ryvangs Allé 1, P.O. Box 2715
DK-2100 Copenhagen Ø

FRANCE

O.N.E.R.A. (ISP)
29 Avenue de la Division Leclerc
BP 72, 92322 Châtillon Cedex

GERMANY

Streitkräfteamt / Abteilung III
Fachinformationszentrum der
Bundeswehr, (FIZBw)
Friedrich-Ebert-Allee 34
D-53113 Bonn

GREECE (Point of Contact)

Hellenic Ministry of National
Defence
Defence Industry Research &
Technology General Directorate
Technological R&D Directorate
D.Soutsou 40, GR-11521, Athens

HUNGARY

Department for Scientific
Analysis
Institute of Military Technology
Ministry of Defence
H-1525 Budapest P O Box 26

ICELAND

Director of Aviation
c/o Flugrad
Reykjavik

ITALY

Centro di Documentazione
Tecnico-Scientifica della Difesa
Via XX Settembre 123a
00187 Roma

LUXEMBOURG

See Belgium

NETHERLANDS

NDRCC
DGM/DWO0
P.O. Box 20701
2500 ES Den Haag

NORWAY

Norwegian Defence Research
Establishment
Attn: Biblioteket
P.O. Box 25, NO-2007 Kjeller

POLAND

Chief of International Cooperation
Division
Research & Development
Department
218 Niepodleglosci Av.
00-911 Warsaw

PORTUGAL

Estado Maior da Força Aérea
SDFA - Centro de Documentação
Alfragide
P-2720 Amadora

SPAIN

INTA (RTO/AGARD Publications)
Carretera de Torrejón a Ajalvir, Pk.4
28850 Torrejón de Ardoz - Madrid

TURKEY

Millî Savunma Başkanlığı (MSB)
ARGE Dairesi Başkanlığı (MSB)
06650 Bakanlıklar - Ankara

UNITED KINGDOM

Defence Research Information
Centre
Kentigern House
65 Brown Street
Glasgow G2 8EX

UNITED STATES

NASA Center for AeroSpace
Information (CASI)
Parkway Center
7121 Standard Drive
Hanover, MD 21076-1320

SALES AGENCIES

NASA Center for AeroSpace
Information (CASI)

Parkway Center
7121 Standard Drive
Hanover, MD 21076-1320
United States

The British Library Document
Supply Centre

Boston Spa, Wetherby
West Yorkshire LS23 7BQ
United Kingdom

Canada Institute for Scientific and
Technical Information (CISTI)

National Research Council
Document Delivery
Montreal Road, Building M-55
Ottawa K1A 0S2, Canada

Requests for RTO or AGARD documents should include the word 'RTO' or 'AGARD', as appropriate, followed by the serial number (for example AGARD-AG-315). Collateral information such as title and publication date is desirable. Full bibliographical references and abstracts of RTO and AGARD publications are given in the following journals:

Scientific and Technical Aerospace Reports (STAR)

STAR is available on-line at the following uniform
resource locator:

<http://www.sti.nasa.gov/Pubs/star/Star.html>

STAR is published by CASI for the NASA Scientific
and Technical Information (STI) Program
STI Program Office, MS 157A
NASA Langley Research Center
Hampton, Virginia 23681-0001
United States

Government Reports Announcements & Index (GRA&I)

published by the National Technical Information Service
Springfield
Virginia 22161
United States
(also available online in the NTIS Bibliographic
Database or on CD-ROM)



Printed by St. Joseph Ottawa/Hull
(A St. Joseph Corporation Company)
45 Sacré-Cœur Blvd., Hull (Québec), Canada J8X 1C6