



**Calhoun: The NPS Institutional Archive**  
**DSpace Repository**

---

Theses and Dissertations

1. Thesis and Dissertation Collection, all items

---

1972

A study of supersonic flow past vibrating panels and shells.

Webster, Kenneth Allen.

Monterey, California. Naval Postgraduate School

---

<https://hdl.handle.net/10945/16390>

---

*Downloaded from NPS Archive: Calhoun*



Calhoun is the Naval Postgraduate School's public access digital repository for research materials and institutional publications created by the NPS community. Calhoun is named for Professor of Mathematics Guy K. Calhoun, NPS's first appointed -- and published -- scholarly author.

**Dudley Knox Library / Naval Postgraduate School**  
**411 Dyer Road / 1 University Circle**  
**Monterey, California USA 93943**

<http://www.nps.edu/library>

A STUDY OF SUPERSONIC FLOW  
PAST VIBRATING PANELS AND SHELLS

Kenneth Allen Webster



# NAVAL POSTGRADUATE SCHOOL

Monterey, California

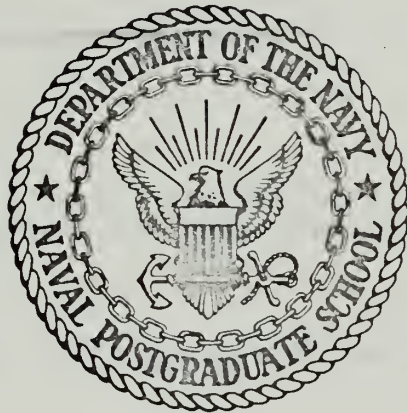

## THESIS

A STUDY OF SUPERSONIC FLOW  
PAST VIBRATING PANELS AND SHELLS

by

Kenneth Allen Webster

Thesis Advisor:

M. F. Platzer

March 1972

*Approved for public release; distribution unlimited.*



A Study of Supersonic Flow  
Past Vibrating Panels and Shells

by

Kenneth Allen Webster  
Lieutenant Commander, United States Naval Reserve  
B.S., Naval Postgraduate School, 1971

Submitted in partial fulfillment of the  
requirements for the degree of

MASTER OF SCIENCE IN AERONAUTICAL ENGINEERING

from the

NAVAL POSTGRADUATE SCHOOL  
March 1972



## ABSTRACT

Supersonic flow past harmonically vibrating two-dimensional panels and cylindrical shells is analyzed using a linearized method-of-characteristics procedure. A detailed description of this method to solve the linearized unsteady potential equation is given and numerical results are presented to indicate the nature of the aerodynamic pressure distributions. Also, comparisons of the present results are made with earlier work by Nelson and Cunningham and by Anderson which is based upon quite different approaches.





## TABLE OF CONTENTS

|                           |  |    |
|---------------------------|--|----|
| I.                        | INTRODUCTION -----                           | 8  |
| II.                       | PROBLEM FORMULATION -----                    | 10 |
| III.                      | NUMERICAL TECHNIQUE -----                    | 21 |
|                           | A. METHOD OF CHARACTERISTICS -----           | 21 |
|                           | B. FORMULATION OF EQUATIONS PROGRAMMED ----- | 26 |
|                           | C. TEST CASES -----                          | 34 |
| IV.                       | PROGRAM ORGANIZATION AND OPERATION -----     | 36 |
|                           | A. GENERAL ORGANIZATION -----                | 36 |
|                           | B. MAIN PROGRAM OPERATION -----              | 39 |
|                           | C. SUBROUTINE COMPRX OPERATION -----         | 40 |
|                           | D. SUBROUTINE MACHLN OPERATION -----         | 41 |
|                           | E. SUBROUTINE PANPT OPERATION -----          | 41 |
|                           | F. SUBROUTINE GENFPT OPERATION -----         | 41 |
| V.                        | RESULTS AND DISCUSSION -----                 | 42 |
| VI.                       | SUMMARY AND CONCLUSIONS -----                | 57 |
| APPENDIX A:               | VIBRATING PANEL COMPUTER PROGRAM -----       | 58 |
| APPENDIX B:               | VIBRATING SHELL COMPUTER PROGRAM -----       | 67 |
| APPENDIX C:               | VIBRATING PANEL SAMPLE COMPUTER OUTPUT-----  | 77 |
| APPENDIX D:               | VIBRATING SHELL SAMPLE COMPUTER OUTPUT-----  | 86 |
| REFERENCES                | -----  | 95 |
| INITIAL DISTRIBUTION LIST | -----  | 97 |
| FORM DD 1473              | -----  | 98 |



## LIST OF ILLUSTRATIONS

### FIGURE

1. Panel and Shell Geometry
2. Propagation problem in an open domain
3. Characteristic curves
4. General field point example
5. Initial mach line example
6. Panel point example
7. Computer program algorithm
8. Grid system diagram
9. Method of singularities vibrating panel comparison
10. Method of singularities vibrating panel comparison
11. Program output for vibrating panel comparison
12. Program output for vibrating panel comparison
13. Method of singularities vibrating panel comparison
14. Method of singularities vibrating panel comparison
15. Program output for vibrating panel comparison
16. Program output for vibrating panel comparison
17. Program output for vibrating shell comparison



## LIST OF SYMBOLS

|           |  |
|-----------|--|
| $A_1$     | See Eq. 5.2                                  |
| $a$       | Speed of sound                               |
| $c$       | Free stream speed of sound                   |
| $C_p$     | Coefficient of pressure                      |
| $E$       | Energy                                       |
| $e$       | 2.718282                                     |
| $h$       | Radial deflection                            |
| $i$       | The square root of minus one                 |
| $K$       | Reduced frequency                            |
| $L$       | Cylinder length                              |
| $l$       | Axial wave length                            |
| $M$       | Free stream Mach number                      |
| $m$       | Axial mode number of the cylinder            |
| $n$       | Circumferential mode number of the cylinder  |
| $P$       | Pressure                                     |
| $\bar{p}$ | Pressure perturbation ( $P - P_\infty$ )     |
| $q$       | Heat   |
| $R$       | Cylinder radius                              |
| $r$       | Radial coordinate                            |
| $S$       | Entropy                                      |
| $s$       | Increment of distance along a characteristic |
| $T$       | Temperature                                  |
| $t$       | Time   |
| $U$       | Free stream velocity in x direction          |
| $\bar{u}$ | Velocity component in x direction            |
| $v$       | Velocity component in y direction            |



|                |                                     |
|----------------|-------------------------------------|
| $w$            | Velocity component in $z$ direction |
| $W$            | Total velocity                      |
| $x, y, z$      | Rectangular coordinates             |
| $x, r, \theta$ | Cylindrical coordinates             |
| $Z(x)$         | Radial deflection amplitude         |
| $\alpha$       | Mach angle                          |
| $\rho$         | Density                             |
| $\Phi$         | Non-dimensional velocity potential  |
| $\phi$         | Perturbation velocity potential     |
| $\phi$         | Velocity potential                  |
| $\psi_1$       | Force phase angle                   |





## ACKNOWLEDGEMENTS

The author gratefully acknowledges the assistance provided in this study by the following persons:

Professor M. F. Platzler of the Naval Postgraduate School, the thesis advisor, whose understanding, patience and guidance insured the worth of this thesis.

Lieutenant H. G. Chalkley of the Naval Postgraduate School, who kindly provided help in the Fortran programming.

My wife, Sandra, for her invaluable assistance with the thesis.



## I. INTRODUCTION

The determination of the pressure distribution over vibrating panels and shells is a prerequisite for the study of aeroelastic stability. This problem has been previously considered by a number of investigators, who applied either various asymptotic approximation techniques (e.g., piston theory) or operational methods to the solution of the linearized unsteady potential equation. For a recent comprehensive review of this subject refer to Reference 7. In the present study a quite different approach is developed; i.e., the method of characteristics is used to obtain a solution to the problem of supersonic flow past vibrating panels and shells.

The major assumptions in the mathematical model are that we are dealing with a perfect gas, that the flow is irrotational and supersonic, and that linearization is permissible. Reference 1 was used to help develop the linearized unsteady potential equation and the boundary conditions for panels and shells. These equations were then rewritten in cylindrical coordinates.

Steady supersonic flow past bodies of revolution was studied by several authors using linearized characteristics methods; i.e., Haack [Ref. 9], Sauer [Ref. 10], Oswatitsch and Erdmann [Ref. 11]. Teipel [Ref. 12] developed a characteristics procedure for two-dimensional supersonic flow past airfoils oscillating at arbitrary frequency using the



velocity perturbations and the velocity of sound perturbation as dependent variables. Platzer and Sherer [Ref. 13] gave an extension of the Oswatitsch-Erdmann method to slowly oscillating bodies of revolution.

In the present report a linearized characteristics method is presented to study supersonic flow past cylindrical shells vibrating at arbitrary frequency. The velocity potential function is introduced as the dependent variable and the linearized unsteady potential equation is solved subject to the proper boundary conditions. Although two-dimensional flow past vibrating panels is contained in this solution as a special case for infinite shell radius, two separate programs were written in Fortran IV code for the IBM 360 system, one for panels and one for shells. Thus, the panel program is complementary to Teipel's work in that it uses the velocity potential rather than the velocity perturbations as dependent variables. The method of singularities [Ref. 4] served as an independent method to verify the results. Anderson's work, on the other hand, was used to compare the method-of-characteristics predictions for cylindrical shells.



## II. PROBLEM FORMULATION

In nearly all engineering studies some basic assumptions have to be made to formulate the problem. In this study this assumption is that the compressible medium with which we are dealing is a perfect gas. We therefore have the equation of state for a gas

$$P = \rho RT \quad (2.1)$$

Flow of a perfect gas is then completely described by expressing the ambient quantities  $P, \rho$  and  $T$  as well as the velocity components  $\bar{u}, v, w$  as a function of position  $x, y, z$  and time  $t$ . These six dependent variables are always related by the conditions of conservation of mass, momentum and energy as developed in Johns [Ref. 1].

Conservation of Mass

$$\frac{\partial(\rho u)}{\partial x} + \frac{\partial(\rho v)}{\partial y} + \frac{\partial(\rho w)}{\partial z} + \frac{\partial \rho}{\partial t} = 0 \quad (2.2)$$

Conservation of Momentum

$$\begin{aligned} -\frac{1}{\rho} \frac{\partial P}{\partial x} &= \frac{\partial \bar{u}}{\partial t} + \bar{u} \frac{\partial \bar{u}}{\partial x} + v \frac{\partial \bar{u}}{\partial y} + w \frac{\partial \bar{u}}{\partial z} \\ -\frac{1}{\rho} \frac{\partial P}{\partial y} &= \frac{\partial v}{\partial t} + \bar{u} \frac{\partial v}{\partial x} + v \frac{\partial v}{\partial y} + w \frac{\partial v}{\partial z} \\ -\frac{1}{\rho} \frac{\partial P}{\partial z} &= \frac{\partial w}{\partial t} + \bar{u} \frac{\partial w}{\partial x} + v \frac{\partial w}{\partial y} + w \frac{\partial w}{\partial z} \end{aligned} \quad (2.3)$$





## Conservation of Energy

$$\frac{D}{Dt} \left[ E + \frac{W^2}{2} \right] = -\frac{1}{\rho} \left[ \frac{\partial}{\partial x}(\bar{u}P) + \frac{\partial}{\partial y}(vP) + \frac{\partial}{\partial z}(wP) \right] \quad (2.4)$$

where

$$W^2 = \bar{u}^2 + v^2 + w^2. \quad (2.5)$$

Equation 2.4 can also be stated as (See Ref. 1)

$$\frac{DS}{Dt} = 0 \quad (2.6)$$

The condition of conservation of energy therefore reduces to the simple statement that the entropy of a fluid particle remains constant. For later convenience we now rewrite the continuity equation, Eq. 2.2

$$\frac{D\rho}{Dt} + \rho \left( \frac{\partial \bar{u}}{\partial x} + \frac{\partial v}{\partial y} + \frac{\partial w}{\partial z} \right) = 0 \quad (2.7)$$

Introducing the speed of sound

$$a^2 = \frac{\partial P}{\partial \rho} \quad (2.8)$$

we have

$$\frac{D\rho}{Dt} = \frac{\partial \rho}{\partial P} \frac{DP}{Dt} = \frac{1}{a^2} \frac{DP}{Dt}$$

Therefore the continuity equation can also be written

$$\frac{DP}{Dt} = -\rho a^2 \left( \frac{\partial \bar{u}}{\partial x} + \frac{\partial v}{\partial y} + \frac{\partial w}{\partial z} \right) \quad (2.9)$$

The velocity potential is introduced to reduce the number of dependent variables. Its existence depends upon the condition of irrotationality of the flow. This condition



is expressed mathematically by the vanishing of the curl of the velocity vector and can be written in component form

$$\frac{\partial v}{\partial x} - \frac{\partial \bar{u}}{\partial y} = 0, \quad \frac{\partial w}{\partial y} - \frac{\partial v}{\partial z} = 0, \quad \frac{\partial \bar{u}}{\partial z} - \frac{\partial w}{\partial x} = 0. \quad (2.10)$$

It can be shown by Kelvin's theorem [Ref. 2] that flows starting either from reservoirs or from parallel streamlines and being irrotational initially will remain so. Only strong shock or intense heat will require a reformulation of this law. However, such effects are usually quite unimportant in aeroelastic considerations. Therefore, Eq. 2.10 is necessary and sufficient to derive the velocity components  $\bar{u}$ ,  $v$ ,  $w$  from the velocity potential  $\phi$  such that

$$\bar{u} = \frac{\partial \phi}{\partial x}, \quad v = \frac{\partial \phi}{\partial y}, \quad w = \frac{\partial \phi}{\partial z}. \quad (2.11)$$

Therefore the continuity equation can be written

$$-\frac{1}{\rho} \frac{D\rho}{Dt} = \frac{\partial \bar{u}}{\partial x} + \frac{\partial v}{\partial y} + \frac{\partial w}{\partial z} = \frac{\partial^2 \phi}{\partial x^2} + \frac{\partial^2 \phi}{\partial y^2} + \frac{\partial^2 \phi}{\partial z^2} \quad (2.12)$$

In vector form the Eulerian equations of motion can also be written as

$$\frac{\partial \vec{v}}{\partial t} + (\vec{v} \cdot \text{grad})\vec{v} = -\frac{1}{\rho} \text{grad } P. \quad (2.13)$$

This is equivalent in irrotational barotropic flow to

$$\frac{\partial}{\partial t} \text{grad } \phi + \text{grad} \left( \frac{W^2}{2} \right) = -\frac{1}{\rho} \text{grad } P \quad (2.14)$$



or

$$\text{grad} \left[ \frac{\partial \phi}{\partial t} + \frac{W^2}{2} + \int \frac{dP}{\rho} \right] = 0$$

Integration therefore gives

$$\frac{\partial \phi}{\partial t} + \frac{W^2}{2} + \int \frac{dP}{\rho} = C(t) \quad (2.15)$$

Moreover,  $C(t) = \frac{1}{2} U^2$  whenever the remote fluid motion consists of parallel streamlines with velocity  $U$ . The partial derivative of Eq. 2.15 with respect to time is

$$- \frac{\partial}{\partial t} \left[ \frac{\partial \phi}{\partial t} + \frac{W^2}{2} \right] = \frac{\partial}{\partial t} \int \frac{dP}{\rho} = \frac{1}{\rho} \frac{\partial P}{\partial t} \quad (2.16)$$

In rewriting the continuity equation

$$\phi_{xx} + \phi_{yy} + \phi_{zz} + \frac{1}{a^2 \rho} \left[ \phi_x \frac{\partial P}{\partial x} + \phi_y \frac{\partial P}{\partial y} + \phi_z \frac{\partial P}{\partial z} + \frac{\partial P}{\partial t} \right] = 0 \quad (2.17)$$

one obtains therefore as a result of Eqs. 2.3 and 2.16

$$\begin{aligned} & \left( 1 - \frac{\phi^2}{a^2} \frac{x}{x} \right) \phi_{xx} + \left( 1 - \frac{\phi^2}{a^2} \frac{y}{y} \right) \phi_{yy} + \left( 1 - \frac{\phi^2}{a^2} \frac{z}{z} \right) \phi_{zz} + \\ & - \frac{2\phi_x \phi_y}{a^2} \phi_{xy} - \frac{2\phi_x \phi_z}{a^2} \phi_{xz} - \frac{2\phi_y \phi_z}{a} \phi_{yz} + \\ & - \frac{2\phi_x}{a^2} \phi_{xt} - \frac{2\phi_y}{a^2} \phi_{yt} - \frac{2\phi_z}{a^2} \phi_{zt} - \frac{1}{a^2} \phi_{tt} = 0 \end{aligned} \quad (2.18)$$

Let  $a$  denote the speed of sound. For infinitely large speeds of sound (incompressible flow) the above equation reduces to Laplace's equation. Equation 2.18 is the



governing differential equation for general nonstationary, nonviscous, potential flow and is not limited to small disturbances. However, because of its nonlinear nature, solutions were found only in very few special cases. Therefore, it is necessary to introduce the small disturbance concept. Regarding all velocity disturbances small in comparison with  $U$ ,  $a$ , and  $(U - a)$  and pressure differences and density changes small in comparison with main stream pressure and density, a perturbation potential  $\phi$  is introduced so that

$$\phi = Ux + \phi \quad (2.19)$$

If  $a$  is expanded around its value for the undisturbed stream the procedure of retaining only first order terms leads to the following equation for the disturbance velocity potential

$$(1-M^2)\phi_{xx} + \phi_{yy} + \phi_{zz} - \frac{2M}{c}\phi_{xt} - \frac{1}{c^2}\phi_{tt} = 0 \quad (2.20)$$

where  $c$  is the constant value of the speed of sound in the uniform stream and  $M$  the constant free-stream Mach number. It is this linearized unsteady potential Eq. 2.20 which is being used in most aeroelastic analyses as the basic equation to predict the oscillatory pressures and generalized aerodynamic forces. However, it must be emphasized that its validity is restricted to purely subsonic or supersonic flows, as well as to sufficiently unsteady transonic flows.





Expressing Eq. 2.20 in cylindrical coordinates one has

$$\phi_{xx} + \phi_{rr} + \frac{1}{r} \phi_r + \frac{1}{r^2} \phi_{\theta\theta} - \frac{1}{c^2} \left[ \phi_{tt} + 2U\phi_{xt} + U^2\phi_{xx} \right] = 0 \quad (2.21)$$

There are two main boundary conditions applicable to a vibrating cylinder in supersonic flow. The first is that the panel surface is impenetrable to the gas, i.e., the flow is tangential to the surface at each instant of time. The second condition is prescribed by the Sommerfeld radiation condition which requires waves to propagate away from sources of disturbance toward infinity. Furthermore, uniform supersonic flow must exist upstream of the panel leading edge, since no disturbances can propagate upstream.

If the equation of the surface of a body which is moving in a time-dependent manner is given by

$$F(x, y, z, t) = 0 \quad (2.22)$$

then it can be shown that the flow tangency condition requires [Ref. 8]

$$\frac{DF}{Dt} = \frac{\partial F}{\partial t} + \bar{u} \frac{\partial F}{\partial x} + v \frac{\partial F}{\partial y} + w \frac{\partial F}{\partial z} = 0 \quad (2.23)$$

This condition states that the rate of change of the numerical value of the function  $F$  is zero, when we follow the motion of a particular fluid element (substantial derivative), so that the element continually touches the surface  $F = 0$ .

Consider a two-dimensional panel (Fig. 1a) whose chord is



aligned with the x-axis and whose upper surface is exposed to a uniform flow of velocity U in the positive x-direction. We then find that we can describe the body by

$$F = z - h(x, t) = 0 \quad (2.24)$$

Since  $\frac{\partial F}{\partial z} = 1$  we have from the boundary condition

$$w = \frac{\partial h}{\partial t} + \bar{u} \frac{\partial h}{\partial x} \quad \text{For } z = h(x, t) \quad (2.25)$$

Imposing the linear perturbation assumption Eq. 2.19 we have

$$\phi = Ux + \varphi \quad (2.19)$$

where the disturbance velocity components are obtained from

$$u = \frac{\partial \varphi}{\partial x}, \quad w = \frac{\partial \varphi}{\partial z} \quad (2.26)$$

and satisfy the order-of-magnitude requirement

$$\bar{u}, w \ll U \quad (2.27)$$

The terms  $u \frac{dh}{dx}$  can then be neglected compared to the much larger term  $U \frac{\partial h}{\partial x}$ . This leads to

$$w = \frac{\partial h}{\partial t} + U \frac{\partial h}{\partial x} \quad (2.28)$$

It can be shown that it is possible to express the flow tangency condition in the plane  $z = 0$ . Taylor series expansion gives

$$w(x, z, t) = w(z, 0^+, t) + h \frac{\partial w(x, 0^+, t)}{\partial z} + \frac{h^2}{2!} \frac{\partial^2 w(x, 0^+, t)}{\partial z^2} + \dots + \quad (2.29)$$



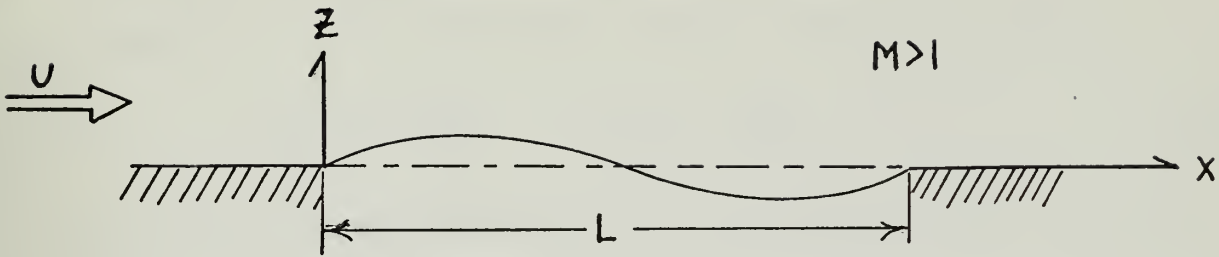
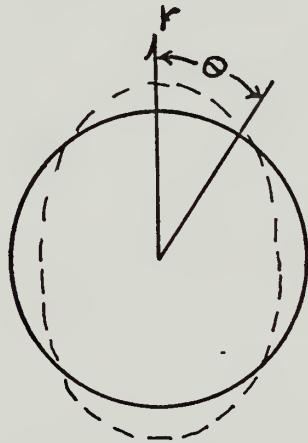
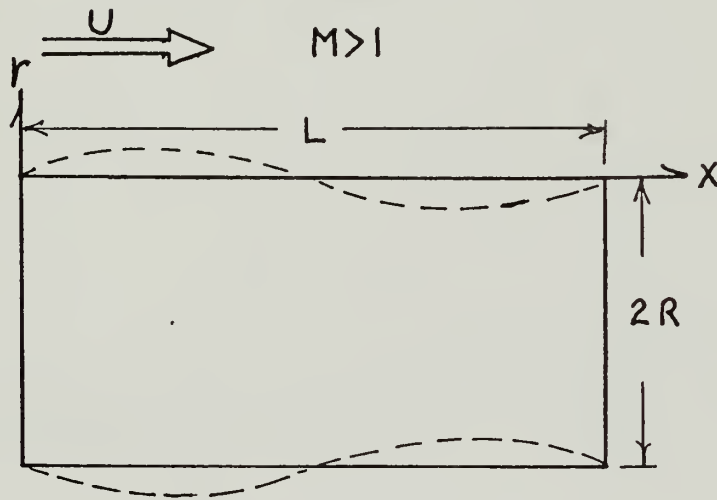

FIGURE 1a TWO-DIMENSIONAL PANEL



THE CASE SHOWN  
IS  $m=2$ ,  $n=2$

FIGURE 1b PROFILE AND CROSS SECTION  
OF CYLINDRICAL SHELL



Using the same argument as above the product terms are neglected so that the flow tangency condition equals

$$w = \frac{\partial h}{\partial t} + U \frac{\partial h}{\partial x} \quad \text{for } z = 0^+ \quad (2.30)$$

A similar consideration for the cylindrical shell (Fig. 1b) whose vibration mode is given by

$$h(x, \theta, t) = Z(x) \cos n\theta e^{i\omega t} \quad (2.31)$$

results in the following boundary conditions

$$\left. \frac{\partial \phi}{\partial r} \right|_{r=R} = U \left[ \frac{\partial Z}{\partial x} + i\omega Z \right] \cos n\theta e^{i\omega t}$$

$$= 0 \quad \begin{array}{l} \text{for } 0 < x < L \\ \text{for } x < 0 \end{array} \quad (2.32)$$

The calculation of perturbation pressures and pressure coefficients begins with Eq. 2.15

$$\frac{\partial \phi}{\partial t} + \frac{W^2}{2} + \int \frac{dP}{\rho} = C(t)$$

For uniform parallel flow far upstream we have

$$C(t) = \frac{U^2}{2} .$$

Using again the perturbation assumption, Eq. 2.19

$$\phi = Ux + \Phi$$

and noting that

$$W^2 = \left( U + \frac{\partial \Phi}{\partial x} \right)^2 + \left( \frac{\partial \Phi}{\partial y} \right)^2 + \left( \frac{\partial \Phi}{\partial z} \right)^2 \quad (2.5)$$

we can approximate

$$\frac{\partial \phi}{\partial t} + \frac{W^2}{2} = \frac{\partial \phi}{\partial t} + \frac{U^2}{2} + U \frac{\partial \Phi}{\partial x} \quad (2.33)$$





by dropping second order terms. Also the density-pressure relation is expanded as

$$\rho(p) = \rho_{\infty} + \left(\frac{d\rho}{dp}\right)_{\infty} (p-p_{\infty}) + \frac{1}{2!} \left(\frac{d^2\rho}{dp^2}\right)_{\infty} (p-p_{\infty})^2 + \dots \quad (2.34)$$

Therefore

$$\int_{p_{\infty}}^p \frac{dp}{\rho(p)} = \int_{p_{\infty}}^p \frac{dp}{\rho_{\infty} \left[ 1 + \left(\frac{d\rho}{dp}\right)_{\infty} \frac{p-p_{\infty}}{\rho_{\infty}} \right]} = \frac{1}{\rho_{\infty}} \int_{p_{\infty}}^p \left[ 1 - \frac{p-p_{\infty}}{\rho_{\infty}} \right] dp \doteq \frac{p-p_{\infty}}{\rho_{\infty}} \quad (2.35)$$

Hence, the perturbation pressure is related to the perturbation potential by

$$p-p_{\infty} = -\rho_{\infty} \left[ \frac{\partial}{\partial t} + U \frac{\partial}{\partial x} \right] \quad (2.36)$$

Writing this equation in pressure-coefficient form one has

$$C_p = \frac{p-p_{\infty}}{\frac{1}{2} \rho_{\infty} U^2} = -\frac{2}{U^2} \frac{\partial \phi}{\partial t} - \frac{2}{U} \frac{\partial \phi}{\partial x} \quad (2.37)$$

Consistent with the assumed cylinder deflection, Eq. 2.31 a velocity potential is now assumed in the form

$$\phi = \phi(x,r) \cos n\theta e^{i\omega t} \quad (2.38)$$

Substituting this into the Eq. 2.21 results in

$$(1-M^2) \phi_{xx} + \phi_{rr} + \frac{1}{r} \phi_r - \frac{n^2}{r^2} \phi - \frac{2i\omega U}{a^2} \phi_x + \frac{\omega^2}{a^2} \phi = 0 \quad (2.39)$$

This is the basic equation for  $\phi(x,r)$ , which needs to be solved, subject to the boundary conditions



$$\left. \frac{\partial \phi}{\partial r} \right|_{r=R} = U \frac{\partial Z}{\partial x} + i\omega Z \quad \text{For } 0 < x < L$$

$$= 0 \quad \text{For } x < 0 \quad (2.40)$$

When non-dimensional coordinates  $\bar{x} = \frac{x}{L}$ ,  $\bar{r} = \frac{r}{L}$  and the reduced frequency  $K = \frac{\omega L}{U}$  are introduced then it is found

$$(1-M^2)\phi_{xx} + \phi_{rr} + \frac{1}{r}\phi_r - \frac{n^2}{r^2}\phi - 2iKM^2\phi_x + K^2M^2\phi = 0 \quad (2.41)$$

The bar has been omitted for simplicity. The boundary condition is

$$\left. \phi_r \right|_{r=R} = \left[ \frac{\partial Z}{\partial x} + iKZ \right] \quad \begin{array}{l} 0 \leq x \leq L \\ x < 0 \end{array}$$

$$= 0 \quad (2.42)$$

Converting  $C_p$  to cylindrical coordinates and using the above non-dimensional coordinates one has

$$C_p = -2 \left[ iK\phi - \phi_x \right] \cos n\theta e^{iKt} \quad (2.43)$$



### III. NUMERICAL TECHNIQUE

#### A. METHOD OF CHARACTERISTICS

Consider the following pair of simultaneous first order partial differential equations for the dependent variables  $u$  and  $v$ ,

$$A_1 \frac{\partial u}{\partial x} + B_1 \frac{\partial u}{\partial y} + C_1 \frac{\partial v}{\partial x} + D_1 \frac{\partial v}{\partial y} = 0 \quad (3.1)$$

$$A_2 \frac{\partial u}{\partial x} + B_2 \frac{\partial u}{\partial y} + C_2 \frac{\partial v}{\partial x} + D_2 \frac{\partial v}{\partial y} = 0$$

where the coefficients  $A_1, \dots, D_2$  are functions of  $u$  and  $v$  but not of  $x$  and  $y$ .

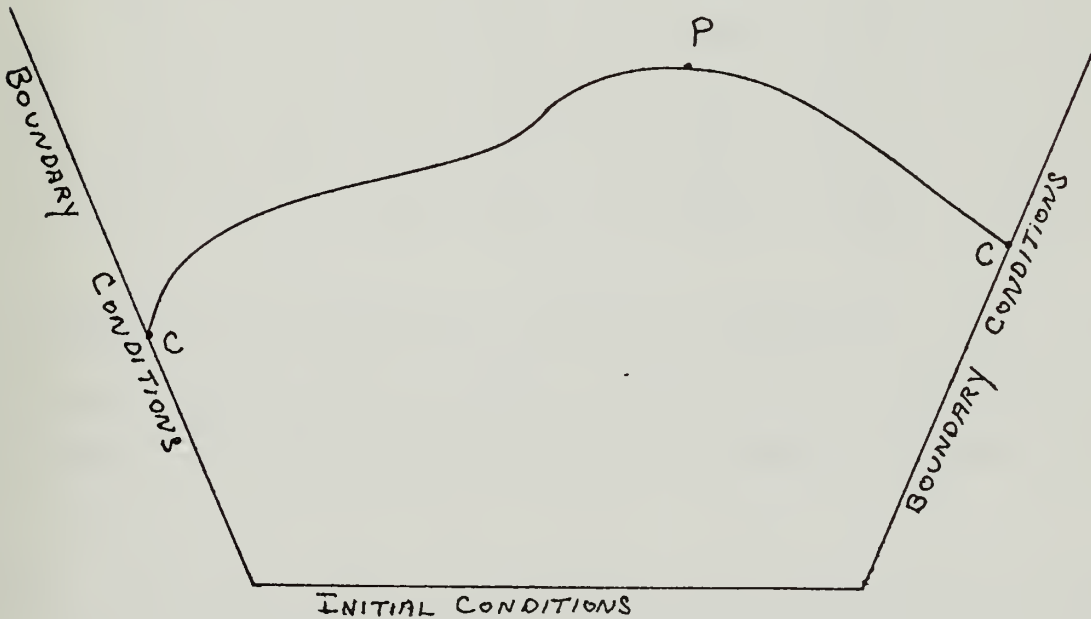

FIGURE 2



Assume that in Figure 1 the solution is known up to the curve CPC. At P one knows continuously differentiable values of u and v along the curve CPC as well as all their derivatives in the directions that lie below the curve. However, the question needs to be answered whether there is enough information to deduce the directional derivatives of u and v at P in directions that lie above the curve.

The directional derivative of u in the direction s is:

$$\frac{\partial u}{\partial s} = \frac{\partial u}{\partial x} \frac{\partial x}{\partial s} + \frac{\partial u}{\partial y} \frac{\partial y}{\partial s} \quad (3.2)$$

so that the directional derivative in any direction is known as soon as the derivatives  $\partial u/\partial x$  and  $\partial u/\partial y$  are known.

To find the values of  $\partial u/\partial x$  and  $\partial u/\partial y$ , write out equations 3.1 at point P and the directional differentials<sup>1</sup> of u and v taken along CPC at P. In matrix form the four equations are:

$$\begin{bmatrix} A_1 & B_1 & C_1 & D_1 \\ A_2 & B_2 & C_2 & D_2 \\ dx & dy & 0 & 0 \\ 0 & 0 & dx & dy \end{bmatrix} \begin{bmatrix} \partial u/\partial x \\ \partial u/\partial y \\ \partial v/\partial x \\ \partial v/\partial y \end{bmatrix} = \begin{bmatrix} 0 \\ 0 \\ du \\ dv \end{bmatrix} \quad (3.3)$$

With u and v known at P the coefficients  $A_1, \dots, D_2$  will also be known. When the directions of CPC are known then dx and dy can be found. If u and v are then known along

---

<sup>1</sup>In Eq. 3.3 du is an abbreviation for  $\partial u/\partial s ds$ , where  $\partial u/\partial s$  is given by Figure 3.2 and s now measures distance along the curve CPC. The symbols dv, dx, and dy stand for similar abbreviations.





CPC,  $du$  and  $dv$  will be known. Equations 3.3 therefore constitute a pair of four simultaneous linear algebraic equations for the four first derivatives. If the determinant of this matrix is not zero, there is a unique solution. In this case satisfaction of these governing equations requires that the directional derivatives have the same value above and below the line CPC. If the matrix determinant had equaled zero, there would not be a unique solution and there could be discontinuities across the line CPC.

Expanding the determinant of Eqs. 3.3 and setting it equal to zero one has

$$(A_1C_2 - A_2C_1)dy^2 - (A_1D_2 - A_2D_1 + B_1C_2 - B_2C_1)dxdy + (B_1D_2 - B_2D_1)dx^2 = 0 \quad (3.4)$$

This is a quadratic equation for the slope  $dy/dx$ . If the direction of the curve CPC at P is such that it has a slope satisfying Eq. 3.4, then the derivatives of  $u$  and  $v$  are not uniquely determined by the values of  $u$  and  $v$  along the curve. Such a direction is called a characteristic direction. The quadratic Eq. 3.4 gives two real slopes, one real slope or a pair of complex slopes, depending upon whether the discriminant

$$(A_1D_2 - A_2D_1 + B_1C_2 - B_2C_1)^2 - 4(A_1C_2 - A_2C_1)(B_1D_2 - B_2D_1) \quad (3.5)$$

is positive, zero or negative. This is also the criterion for cataloging the system Eq. 3.1 as hyperbolic, parabolic, or elliptic. The system is hyperbolic at a point if there



are two real characteristic directions; it is parabolic if there is only a single characteristic direction; or it is elliptic if there are no real characteristic directions at the point.

The foregoing analysis can be repeated for the single-order quasi-linear equation,

$$a \frac{\partial^2 \psi}{\partial x^2} + b \frac{\partial^2 \psi}{\partial x \partial y} + c \frac{\partial^2 \psi}{\partial y^2} = f \quad (3.6)$$

in which  $a$ ,  $b$ ,  $c$ , and  $f$  are functions of  $x$ ,  $y$ ,  $\psi$ ,  $\frac{\partial \psi}{\partial x}$ , and  $\frac{\partial \psi}{\partial y}$ . The characteristic directions are determined from the quadratic

$$a dy^2 - b dx dy + c dx^2 = 0 \quad (3.7)$$

and hence Eq. 3.7 is hyperbolic, parabolic or elliptic at a point according to whether the discriminant  $b^2 - 4ac$  is positive, zero, or negative.

To determine the characteristic curves we return to the pair of first-order Eqs. 3.1 and suppose that the system is hyperbolic throughout the domain of interest. At every point there are two roots,  $(dy/dx)_\alpha$  and  $(dy/dx)_\beta$ , to the quadratic Eqs. 3.4. A curve, which at each of its points has the slope,  $(dy/dx)_\alpha$ , is said to be a  $\alpha$  characteristic; A curve, whose slope is everywhere,  $(dx/dy)_\beta$ , is said to be a  $\beta$  characteristic. Thus there are two families of characteristic curves filling the domain as shown in Figure 3.



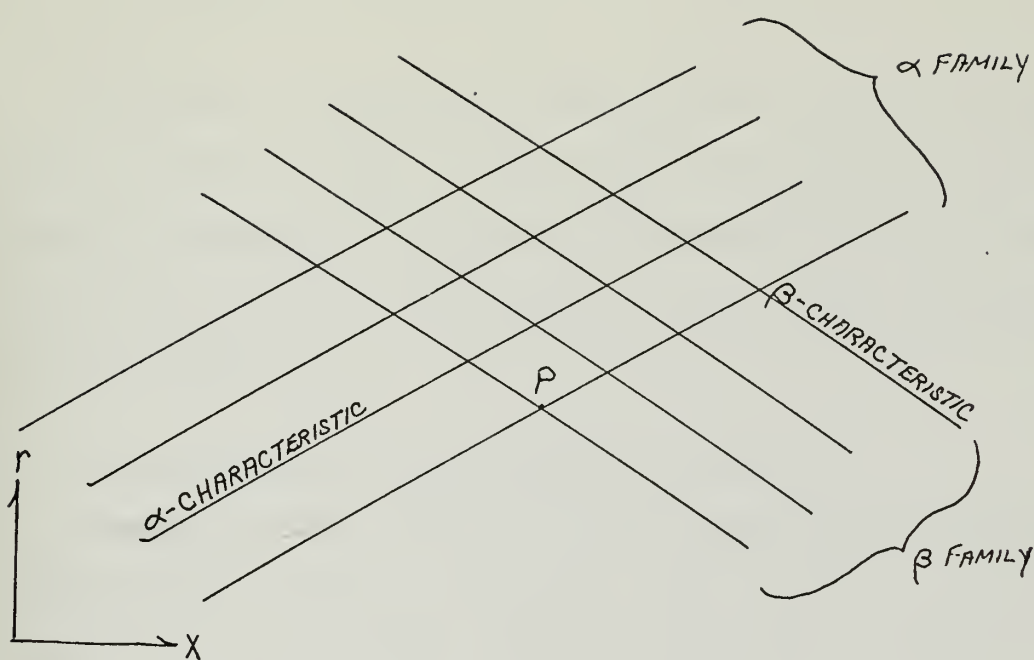

FIGURE 3

If we are considering a characteristic direction so that the determinant in Eq. 3.3 is zero, the right-hand column must be compatible with this if there are to be any solutions at all for the first derivatives; i.e., when the right-hand column is substituted for any of the columns on the left, the resulting determinant must also vanish. Replacing the fourth column on the left with the column on the right and setting the determinant equal to zero leads to

$$(A_1B_2 - A_2B_1)du + \left[ (A_1C_2 - A_2C_1) \frac{dy}{dx} - (B_1C_2 - B_2C_1) \right] dv = 0. \quad (3.8)$$

Insert  $(dy/dx)\alpha$  into Eq. 3.8; it then becomes an ordinary differential equation of  $u$  and  $v$  along the characteristic. A similar equation can be obtained along a  $\beta$  characteristic.



A method of attack has been outlined for solving hyperbolic systems: first, locate the characteristic curves; second, integrate the ordinary differential Eq. 3.8 along the characteristic. This procedure is called the method of characteristics.

#### B. FORMULATION OF THE EQUATIONS PROGRAMMED

In Section II, D, Eq. 2.41 was developed as the partial differential equation for  $\Phi(x,r)$  that needed to be solved subject to the boundary condition Eq. 2.42. If  $M > 1$ , the preceding equation is of the hyperbolic type and possesses real characteristics, which satisfy the ordinary differential equation

$$(M^2 - 1)dr^2 - dx^2 = 0 \quad (3.9)$$

Introduce along the characteristics the arc-length  $ds^2 = M^2 dr^2$  then one has  $X' = \frac{dx}{ds} = \frac{\sqrt{M^2-1}}{M}$ ,  $r' = \frac{dr}{ds} = \frac{1}{M}$  (3.10)

Note: The angle between the characteristics and the x-axis is  $\sin \alpha = \frac{1}{M}$  (3.11)

An arbitrary function  $F(x,r)$  has the following derivative along a characteristic

$$\frac{dF}{ds} = F_x X' + F_r \cdot r' = \frac{\sqrt{M^2-1}}{M} F_x \pm \frac{1}{M} F_r \quad (3.12)$$

Denoting the derivative along the left-running characteristic with  $F_1$ , the derivative along the right-running characteristic with  $F_2$  one has





$$F_1 = \frac{\sqrt{M^2-1}}{M} F_x + \frac{1}{M} F_r, \quad F_2 = \frac{\sqrt{M^2-1}}{M} F_x - \frac{1}{M} F_r \quad (3.13)$$

Solving for  $F_x, F_r$  results in

$$F_r = \frac{M}{2} (F_1 - F_2), \quad F_x = \frac{M}{2\sqrt{M^2-1}} (F_1 + F_2) \quad (3.14)$$

Call  $s_1$  the arc-length of the left-running characteristic, then one has for the second derivatives

$$F_{12} = \frac{dF_1}{ds_2}, \quad F_{21} = \frac{dF_2}{ds_1} \quad (3.15)$$

Hence

$$F_{12} = (F_1)_x \cdot \frac{\sqrt{M^2-1}}{M} - (F_1)_r \cdot \frac{1}{M}$$

and

$$-F_{12} = \frac{1}{M^2} \left[ (1-M^2)F_{xx} + F_{rr} \right] = -F_{21}$$

Therefore the basic equation for  $\phi(x,r)$  was written

$$-M^2 \phi_{12} + \frac{M}{2r} (\phi_1 - \phi_2) - \frac{ikM^3}{\sqrt{M^2-1}} (\phi_1 + \phi_2) + \left( K^2 M^2 - \frac{n^2}{r^2} \right) \phi = 0 \quad (3.16)$$

or

$$\phi_{12} = \frac{\phi_1 - \phi_2}{2rM} - \frac{ikM}{\sqrt{M^2-1}} (\phi_1 + \phi_2) + \left( K^2 - \frac{n^2}{r^2 M^2} \right) \phi$$

This equation was then written in finite difference form.

Using the backward difference form of the finite difference method as developed in Wang Ref. 3 one obtained

$$\left( \frac{\partial \phi}{\partial x} \right)_j = \frac{1}{\Delta S} \left( -\phi_{j-1} + \phi_j \right) \text{ Applying this technique to}$$



Eq. 3.16 where the points A and B were on the right-running characteristic (See Fig. 3) then

$$\frac{\phi_1(B) - \phi_1(A)}{\Delta S} = \frac{\phi_1 - \phi_2}{2rM} - \frac{iKM}{\sqrt{M^2 - 1}} (\phi_1 + \phi_2) + \left( K^2 - \frac{n^2}{r^2 M^2} \right) \phi \quad (3.17)$$

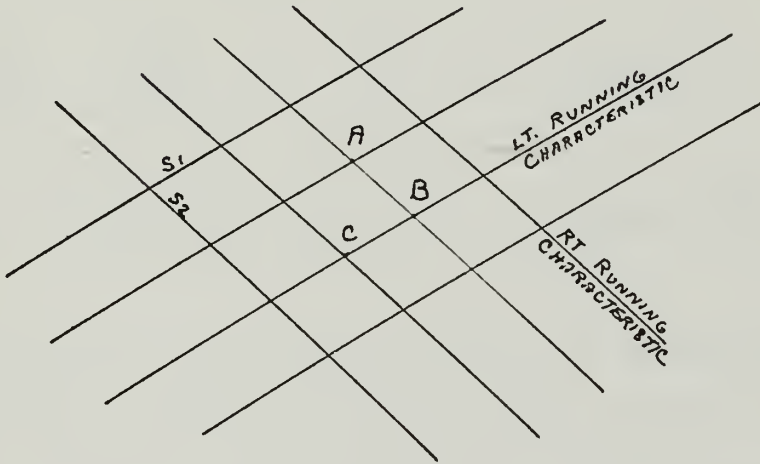

FIGURE 4

The values of  $\phi$ ,  $\phi_1$  and  $\phi_2$  in Eq. 3.17 were not specified at a point. When this equation was first written these values were taken at A, the previous point. It was found in comparing the results in Chapter V that there was a considerable amount of error present. In investigating the source of these errors it was found that if the values for  $\phi$ ,  $\phi_1$  and  $\phi_2$  were averaged between points A and B that these errors disappeared. The value for  $\phi$  at point B was not yet known but it was found by integrating along the characteristic. Using trapezoidal rule

$$\phi(B) = \phi(A) + \frac{1}{2} \left[ \phi_2(A) + \phi_2(B) \right] \Delta S \quad (3.18)$$

Substituting this into Eq. 3.17 where  $\phi(B)$  arises, and using the above averaging technique for  $\phi_1$ ,  $\phi_2$  and  $\phi$  results in



$$\begin{aligned}
\phi_1(B) \left[ 1 - \frac{\Delta S}{4r(B)M} + \frac{iKM}{2\sqrt{M^2-1}} \Delta S \right] &= \phi_1(A) \left[ 1 + \frac{\Delta S}{4r(A)M} - \frac{iKM}{2\sqrt{M^2-1}} \Delta S \right] - \\
\phi_2(B) \left[ \frac{\Delta S}{4r(B)M} + \frac{iKM}{2\sqrt{M^2-1}} \Delta S - \frac{\Delta S^2}{4} \left( K^2 - \frac{n^2}{r^2(B)M^2} \right) \right] &- \\
\phi_2(A) \left[ \frac{\Delta S}{4r(A)M} + \frac{iKM}{2\sqrt{M^2-1}} \Delta S - \frac{\Delta S^2}{4} \left( K^2 - \frac{n^2}{r^2(A)M^2} \right) \right] &+ \quad (3.19) \\
\phi(A) \left[ K^2 - \frac{n^2}{r^2(A)M^2} \right] \frac{\Delta S}{2} + \phi(A) \left[ K^2 - \frac{n^2}{r^2(B)M^2} \right] \frac{\Delta S}{2}
\end{aligned}$$

Similarly to solve for  $\phi_2$  at point B, the above procedure was used except now move along the left running characteristic and integrate  $\phi_1$  along the left running characteristic to find  $\phi(B)$ .

$$\begin{aligned}
\phi_2(B) \left[ 1 - \frac{\Delta S}{4r(B)M} + \frac{iKM}{2\sqrt{M^2-1}} \Delta S \right] &= \phi_2(C) \left[ 1 + \frac{\Delta S}{4r(C)M} - \frac{iKM}{2\sqrt{M^2-1}} \Delta S \right] - \\
\phi_1(B) \left[ \frac{\Delta S}{4r(B)M} + \frac{iKM}{2\sqrt{M^2-1}} \Delta S - \frac{\Delta S^2}{4} \left( K^2 - \frac{n^2}{r^2(B)M^2} \right) \right] &- \\
\phi_1(C) \left[ \frac{\Delta S}{4r(C)M} + \frac{iKM}{2\sqrt{M^2-1}} \Delta S - \frac{\Delta S^2}{4} \left( K^2 - \frac{n^2}{r^2(C)M^2} \right) \right] &+ \quad (3.20) \\
\phi(C) \left[ K^2 - \frac{n^2}{r^2(C)M^2} \right] \frac{\Delta S}{2} + \phi(C) \left[ K^2 - \frac{n^2}{r^2(B)M^2} \right] \frac{\Delta S}{2}
\end{aligned}$$

Then there are two equations [3.19 and 3.20] in two unknowns,  $\phi_1(B)$  and  $\phi_2(B)$ , which can be solved by using Cramer's rule.<sup>2</sup> The following abbreviations are defined as

---

<sup>2</sup> Crandall, S. H., Engineering Analysis, New York, 1956, p. 36.



$$\begin{aligned}
A &= 1 - \frac{\Delta S}{4r(B)M} + \frac{iKM}{2\sqrt{M^2-1}} \Delta S \\
A_1 &= 1 + \frac{\Delta S}{4r(A)M} - \frac{iKM}{2\sqrt{M^2-1}} \Delta S \\
A_2 &= 1 + \frac{\Delta S}{4r(C)M} - \frac{iKM}{2\sqrt{M^2-1}} \Delta S \\
B &= \frac{\Delta S}{4r(B)M} + \frac{iKM}{2\sqrt{M^2-1}} \Delta S - \frac{\Delta S^2}{4} K^2 - \frac{n^2}{r^2(B)M^2} \quad (3.21)
\end{aligned}$$

$$\begin{aligned}
C &= \phi_1(A)A_1 + \phi_2(A) \left[ -\frac{\Delta S}{4r(A)M} - \frac{iKM}{2\sqrt{M^2-1}} + \frac{\Delta S^2}{4} \left( K^2 - \frac{n^2}{r^2(A)M^2} \right) \right] \\
&+ \frac{1}{2} \phi(A) \left[ K^2 - \frac{n^2}{r^2(A)M^2} \right] \Delta S + \frac{1}{2} \phi(A) \left[ K^2 - \frac{n^2}{r^2(B)M^2} \right] \Delta S \\
D &= \phi_2(C)A_2 + \phi_1(C) \left[ -\frac{\Delta S}{4r(C)M} - \frac{iKM}{2\sqrt{M^2-1}} + \frac{\Delta S^2}{4} \left( K^2 - \frac{n^2}{r^2(C)M^2} \right) \right] \\
&+ \frac{1}{2} \phi(C) \left[ K^2 - \frac{n^2}{r^2(C)M^2} \right] \Delta S + \frac{1}{2} \phi(A) \left[ K^2 - \frac{n^2}{r^2(B)M^2} \right] \Delta S
\end{aligned}$$

In terms of these abbreviations the two equations are

$$A\phi_1(B) + B\phi_2(B) = C$$

$$B\phi_1(B) + A\phi_2(B) = D \quad (3.22)$$

Then using Cramer's rule

$$\phi_1(B) = CA - BD/A^2 - B^2$$

$$\phi_2(B) = DA - CD/A^2 - B^2 \quad (3.23)$$

$\phi_1$  was integrated to find  $\phi_1$  along the right running characteristic and as a check  $\phi_2$  was also integrated along the left running characteristic using the trapezoidal rule





$$\begin{aligned}\phi^1(B) &= \phi(A) + \frac{1}{2} \left[ \phi_2(A) + \phi_2(B) \right] \Delta S \\ \phi^2(B) &= \phi(C) + \frac{1}{2} \left[ \phi_1(C) + \phi_1(B) \right] \Delta S\end{aligned}\quad (3.24)$$

The difference  $|\phi^1(B) - \phi^2(B)|$  was a measure of the accuracy. If it becomes too large, the grid size must be made smaller.  $\phi^1(B)$  and  $\phi^2(B)$  were averaged together for the best results.

$$\phi(B) = \frac{1}{2} \left[ \phi^1(B) + \phi^2(B) \right] \quad (3.25)$$

The above procedure will suffice for a general field point which is not subject to a boundary condition once the procedure has been initiated.

On the initial Mach line it is known that  $\phi = 0$ ,  $\phi_1 = 0$ ,  $\Delta\phi_1 = 0$ , therefore from Eqs. 3.20 and 3.21 (See Fig. 5).

$$\begin{aligned}A\phi_2(E) &= A_2\phi_2(D) \\ \phi_2(E) &= \phi_2(D) \frac{A_2}{A}\end{aligned}\quad (3.26)$$

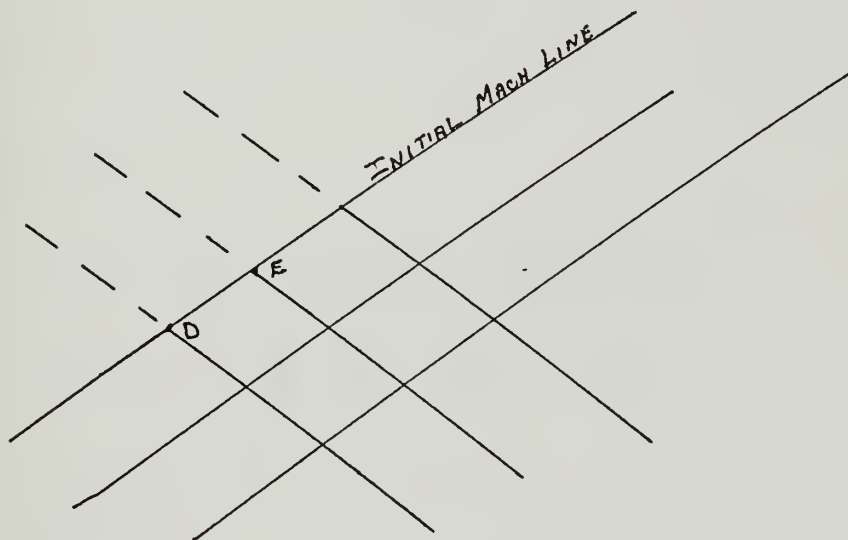

FIGURE 5



At the initial point on the initial Mach line the panel boundary condition also applied, i.e.,

$$\phi_r \Big|_{r=R} = \left[ \frac{\partial Z}{\partial x} + iKZ \right] ,$$

also from Eq. 3.14

$$\phi_r = \frac{M}{2} (\phi_1 - \phi_2)$$

remembering that  $\phi_1 = 0$  and combining the two equations

$$\phi_2 = - \frac{2}{M} \left[ \frac{\partial Z}{\partial x} - iKZ \right] \quad (3.27)$$

On the panel from the above boundary condition (See Fig. 6)

$$\phi_1(L) - \phi_2(L) = - \frac{2}{M} \left[ \frac{\partial Z}{\partial x} + iKZ \right] \quad (3.28)$$

and from Eqs. 3.19 and 3.21  $\phi_1(L) + \phi_2(L)$  was found on the right running characteristic and once again there exists a system of two equations in two unknowns.

$$\phi_1(L) - \phi_2(L) = - \frac{2}{M} \left[ \frac{\partial Z}{\partial x} - iKZ \right] \quad (3.29)$$

$$A\phi_1(L) + B\phi_2(L) = C$$

Using Cramer's rule<sup>3</sup>

$$\begin{aligned} \phi_1(L) &= \left[ C + B \frac{2}{M} \left( \frac{\partial Z}{\partial x} + iKZ \right) \right] / A+B \\ \phi_2(L) &= \left[ - A \frac{2}{M} \left( \frac{\partial Z}{\partial x} + iKZ \right) \right] / A+B \end{aligned} \quad (3.30)$$

---

<sup>3</sup> Ibid.



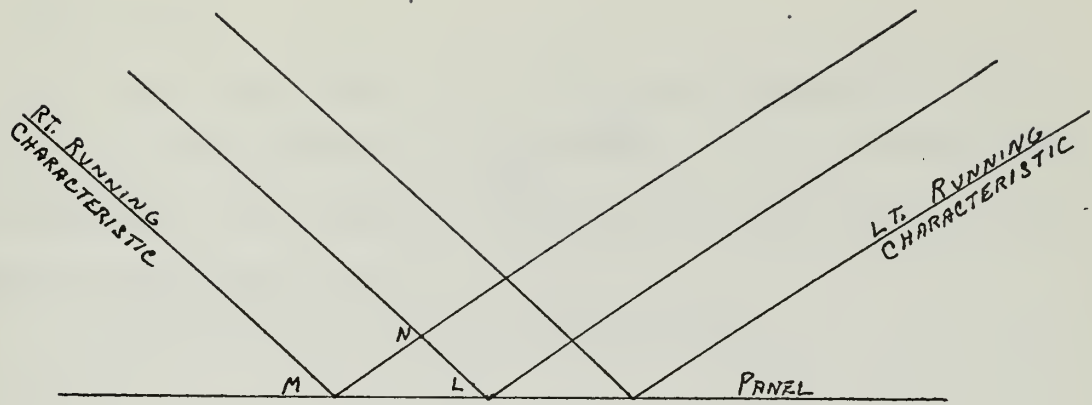

FIGURE 6

To write the program for a vibrating panel or the two-dimensional case, the radius of the cylinder  $r$  was set to infinity. Inspection of the basic equations programmed (Eq. 3.21) showed that  $r$  was always in the denominator, which causes these terms to equal zero. Therefore, terms containing  $r$  were neglected in the Fortran IV encoding of these equations. For the vibrating shell or three dimensional case the full equations as developed were Fortran IV encoded.

Also, it should be noted that the problem was formulated for an arbitrary wall deflection  $Z(x)$ . However, in the numerical computations only the case of a sinusoidal standing wave given by

$$Z(x) = Z_0 \sin(m\pi x) \quad (3.31)$$

was considered. The axial wave-length  $l$  is hence equal to  $L/2m$  where  $m$  is the number of axial half-waves in a given cylinder length  $L$ .



### C. TEST CASES

The first test case considered a two-dimensional flat panel. If the cylinder radius is set at a very large value in relation to the length, then one has essentially a flat panel in supersonic flow.



When MFREQ is set at various values, NFREQ and K set at zero, one then has supersonic flow over a wavy wall as developed in Johns Ref. 1 .

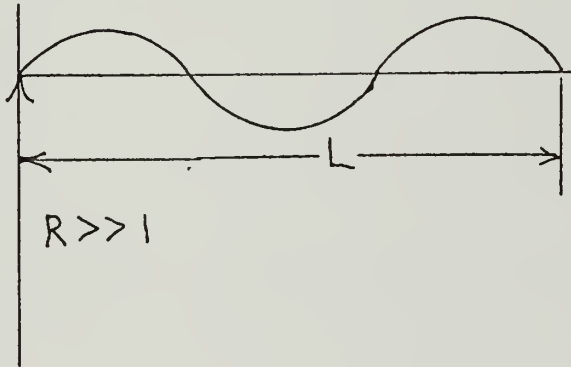

Taking the wavy wall equations for  $\phi$ ,  $\phi_r$  and  $\phi_x$  from Johns Ref. 1 and normalizing results in

$$\begin{aligned}\phi &= - \frac{1}{\sqrt{M^2-1}} \text{Sin} (x - \sqrt{M^2-1} \ r) \\ \phi_r &= \pi \text{Cos} \left[ \pi (x - \sqrt{M^2-1} \ r) \right] \\ \phi_x &= - \frac{\pi}{\sqrt{M^2-1}} \text{Cos} \left[ \pi (x - \sqrt{M^2-1} \ r) \right] \quad (3.31)\end{aligned}$$





By using a large value of  $R$  in the three-dimensional case, it and the two-dimensional case results were then compared to the wavy wall results. These results were found to agree to the fifth significant figure. This case was also used to remove the majority of minor programming errors.

To remove any other hidden programming errors it was decided to set each variable equal to a finite value and to step through the first three characteristic lines by hand. The values were then compared to those computed by the computer. In this manner the rest of the programming bugs were found and removed.



#### IV. COMPUTER PROGRAM ORGANIZATION AND OPERATION

##### A. GENERAL ORGANIZATION

The numerical methods discussed in the foregoing sections have been coded as a FORTRAN IV computer program for the IBM 360 system.

The program consists of a main control section and four subsections or subroutines. An algorithm showing the program information flow and the interaction between the control section and the subroutines was listed in Figure 7. The control section reads in the input data, computes the characteristic grid, computes the initial condition, and computes several constants common to the subroutines. Then subroutine COMPRX is called to compute the coordinates of the next grid point to be calculated, see Figure 8 for a diagram of the characteristic grid used. Two "logical if" statements then determine if the point in question is located on either the initial Mach line, the panel, or at a general field point. Control is then passed to that subroutine to compute the velocity potential and its derivatives along the characteristics at that point. The coefficient of pressure is computed along the panel in subroutine PANPT and after the program has stepped down to the last point on the last characteristic, a listing of the coefficient of pressure at each panel point is printed out.



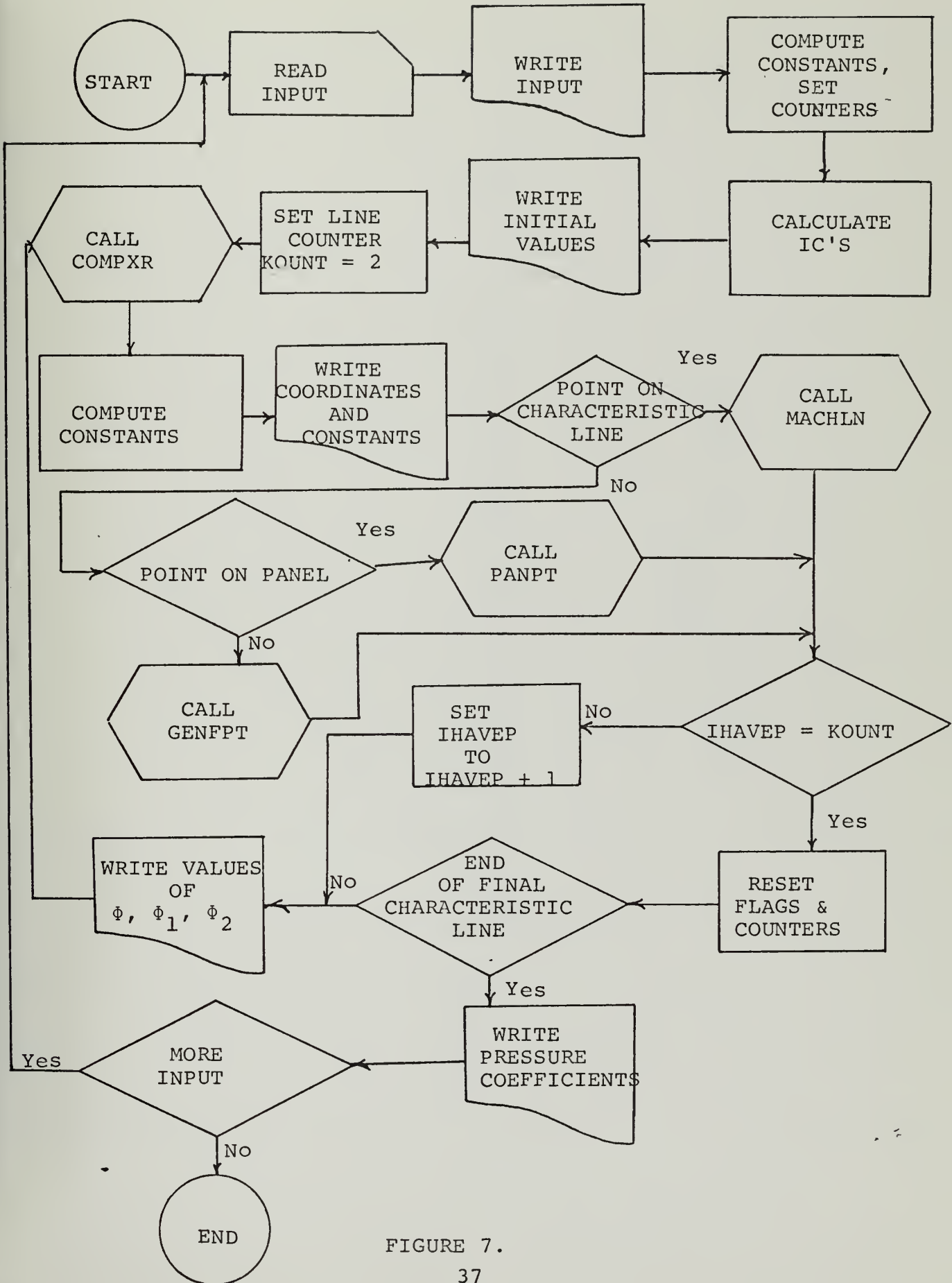

FIGURE 7.



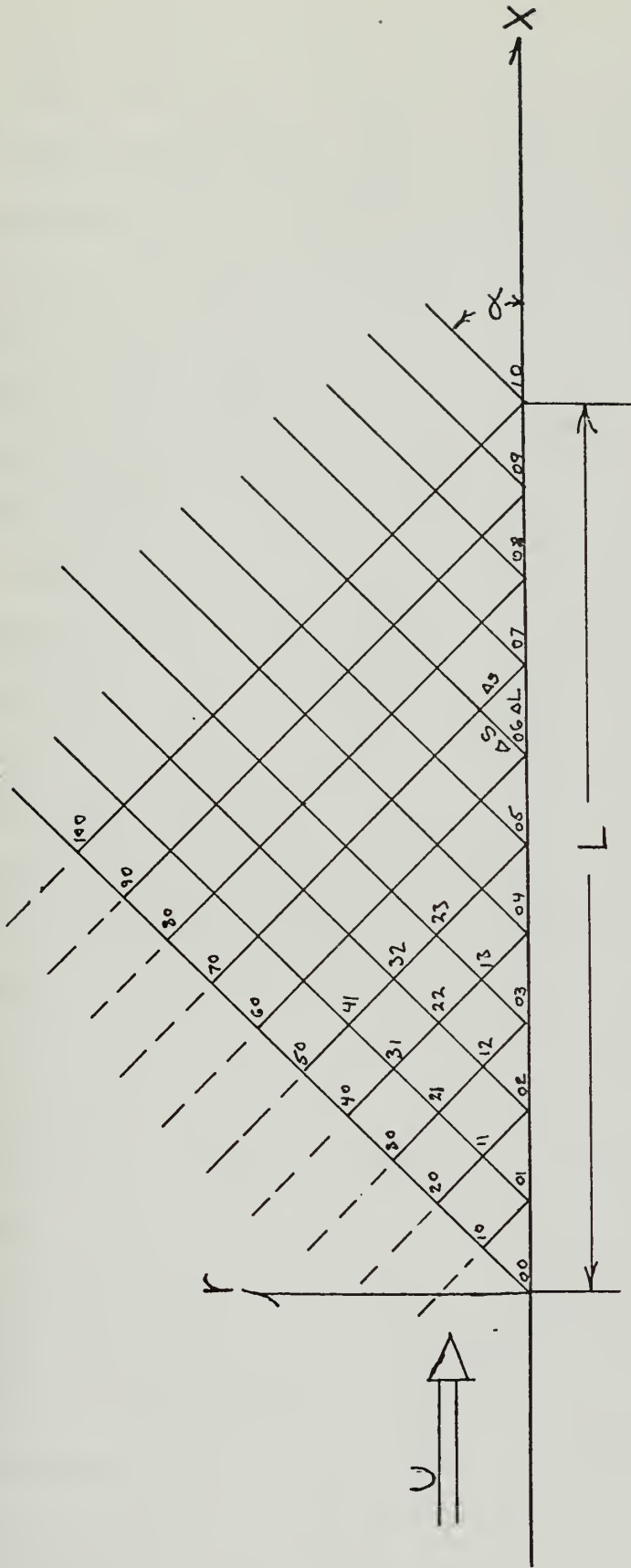

FIGURE 8  
THE CHARACTERISTIC GRID SYSTEM





## B. MAIN CONTROL PROGRAM OPERATION

The main program dimensions the storage requirements in common block form; then it reads three input data cards. The first card has the date of the run in 3A4 format. The second card reads in the fineness of the grid, number of this run, circumferential mode number, and the axial mode number in 4I5 format. The third card reads Mach number, the reduced frequency number, and the cylinder radius in 3F10.4 format. Input is then written to verify input data.

The main program then computes the Mach angle, step sizes, and zeros the counters. The values for the velocity potential and its derivatives and the coordinates of each point are stored as a  $n \times 2$  matrix. As the program steps from characteristic line to characteristic line, only those values for the line being computed and the line just computed are in storage. The initial values at the first point on the initial characteristic is computed using Eq. 3.27 and written out to aid in the program check-out. The line counter, "Kount", is then set at two and subroutine COMPR is called to compute the values of  $x$  and  $r$  at the next point. The main program next computes various quantities dependent on  $x$  and  $r$  which are needed in the other subroutines. The values for  $x$ ,  $r$ , and dependent quantities are printed out as a program debug aid. Two "logical if" statements next determine if the point under consideration is on the initial Mach line, at a general field point, or on the panel. The appropriate subroutine is then called to solve for the velocity potential and its derivatives along the



characteristics at that point. The next "logical if" statement determines if the program must switch lines or step along the present line. Two more "logical if" statements are used to determine if this solution is completed and if there is more data to be read and more solutions to be computed. If "numrun" is set at two, the program will look for more data; if "numrun" equals one, the program will terminate. Before it stops or reads more data the coefficient of pressure along the panel will be printed out for each panel point and an in-line graph, using the IBM scientific library program POLTP, will plot the real and imaginary parts of the coefficient of pressure.

#### C. SUBROUTINE COMPXR OPERATION

Information is passed between the calling program and the subroutines by means of the common storage. The first step in COMPXR is to determine if the point to be computed is on the initial Mach line or not. The coordinates of the last point computed are used and the step distance in the x and r directions either added to or subtracted from them to find the new x and r coordinates. The addition or subtraction depends upon whether we step up to a new characteristic line or down the present characteristic line.



#### D. SUBROUTINE MACHLN OPERATION

In subroutine MACHLN the boundary conditions of the equations developed in the foregoing section are enforced such that the velocity potential and its derivatives along the right running characteristic are set to zero. Equations 3.26 were coded in FORTRAN to solve for  $\phi_2$  at the point in question. The value of  $\phi_2$  and the variables used to solve for  $\phi_2$  are printed out for the first 12 characteristic lines to aid in the program checkout and then control is returned to the main program.

#### E. OPERATION OF SUBROUTINE PANPT

In subroutine PANPT the boundary condition along the panel is enforced. The velocity potential and its derivatives along the characteristics are computed at the point in question, using Eq. 3.29. The real and imaginary parts of the coefficient of pressure are stored for future read out. Control is then returned to the main program.

#### F. OPERATION OF SUBROUTINE GENFPT

GENFPT computes the velocity potential and its first derivatives along the right and left running characteristics. It draws the necessary information from common storage and uses the Eqs. 3.21, 3.22, and 3.23, which were developed in the foregoing chapter. To aid in program check out the variables  $A$ ,  $A_1$ ,  $A_2$ ,  $B$ ,  $C$ , and  $D$  are printed out for the first 12 characteristic lines. Control is then returned to the main program.



## V. RESULTS AND DISCUSSION

The case of a vibrating two-dimensional panel was chosen as the first test of the accuracy of the characteristics method. These results were compared to the results obtained by evaluating the method-of-singularities integrals developed in Ref. 4 for flutter of a two-dimensional panel with one surface exposed to supersonic flow. These integrals were evaluated by applying a 12-point Gaussian Quadrature. The results of these evaluations were available in unpublished notes by M. F. Platzler.

The comparisons for  $M = \sqrt{2}$  at a reduced frequency of 0.5 and an axial mode number of one are shown in Figures 8-11. Figures 8 and 9 are plots of the real and imaginary parts of the coefficient of pressure obtained by the method of singularities. Figures 10 and 11 are plots of the real and imaginary parts of the  $C_p$  for the characteristics method. When these tests were first run it was found that the real parts of the  $C_p$  plots were identical, as shown in Figures 8 and 10. The imaginary parts of  $C_p$ , shown in Figures 9 and 11, did not agree. In rechecking the formulation of the equations it was found that the values of  $\phi$ ,  $\phi_1$  and  $\phi_2$  had not been averaged as explained in Chapter II, Section B, where Eqs. 3.19 and 3.20 were formulated. When these average values were incorporated into the equations, the computer program rewritten and the program rerun, then the two plots were found to be identical for both the real and imaginary parts of the  $C_p$ .





Figures 12-14 are plots for a reduced frequency of two, an axial mode of four, and the same Mach number. These comparisons of the real and imaginary parts of the  $C_p$  were also found to be identical.

In attempting to verify the results of the vibrating shell program, Ref. 5 was used. Reference 5 includes a study of supersonic potential flow past an infinitely long vibrating cylinder. It was not known what effect the difference in an infinitely long cylinder vice a finite length cylinder would have on the outcome, but these were the only published results found that could be used for a comparison of the vibrating shell program.

Two parameters were used to compare the results of the two studies: the maximum amplitude,  $A_1$ , of the sinusoidal  $C_p$  wave, and the phase angle,  $\psi_1$ , of this wave. Equation 14 in Ref. 5 is used to equate  $C_p$  to the value of  $A_1$  listed in Figure 2a of Ref. 5.

$$\bar{p}(x, R, \theta) = \frac{Z_0}{R} \frac{\rho U^2}{M} \frac{m\pi R}{L} \cos n\theta A_1 \cos \left( \frac{m\pi x}{L} + \psi_1 \right)$$

$\bar{p}$  is defined as  $\bar{p} = p - p_\infty$  where

$$C_p = \frac{p - p_\infty}{\frac{1}{2} \rho U^2} \quad (5.1)$$



and the terms,  $Z_0$ ,  $L$ , and  $\overline{\cos(x)}$  were all taken as equal to one then

$$C_p = \frac{\bar{p}}{\frac{1}{2} \rho U^2} = \frac{2}{M} m\pi A_1$$

$$A_1 = C_p \frac{M}{2m\pi} \quad (5.2)$$

Three different values of  $n$  were computed and the coefficients of pressure were listed in Figure 17 as a test case for this comparison. For the case  $n = 0$ , (See Figure 2a of Ref. 5) we find that for the ratio of axial wave length/cylinder radius  $\ell/R = 3.33$ ,  $A_1$  equals 1.05. Using Eq. 5.2 to determine  $A_1$  for a maximum  $C_p$  of 5.63 in Figure 17,  $A_1$  for this study would equal 1.044. Using this same procedure for  $n = 4$  and 8

|         |                      |               |
|---------|----------------------|---------------|
| $n = 4$ | $A_1$ (ref 5) = 1.30 | $A_1 = 1.445$ |
| $n = 8$ | $A_1$ (ref 5) = 1.80 | $A_1 = 1.85.$ |

To compare the phase angle  $\psi_1$ , Figure 2b in Ref. 5 was entered for  $\ell/R = 3.33$  and the three values of  $n$  taken previously. This shift,  $\psi_1$ , was calculated from results (Fig. 17) by determining the zero crossing point.

|         |      |
|---------|------|
| $n = 0$ | 59.8 |
| $n = 4$ | 57.7 |
| $n = 8$ | 48.9 |

Converting these zero crossing points to angular shifts, it was found that



|       |                 |                       |
|-------|-----------------|-----------------------|
| n = 0 | $\psi_1 = 4.8$  | $\psi_1$ (ref 5) = 5  |
| n = 4 | $\psi_1 = 13.5$ | $\psi_1$ (ref 5) = 10 |
| n = 8 | $\psi_1 = 55.4$ | $\psi_1$ (ref 5) = 60 |

which compare favorably with Anderson's values listed in the third column.



$$M = \sqrt{2}, m = 1, K = 0.5$$

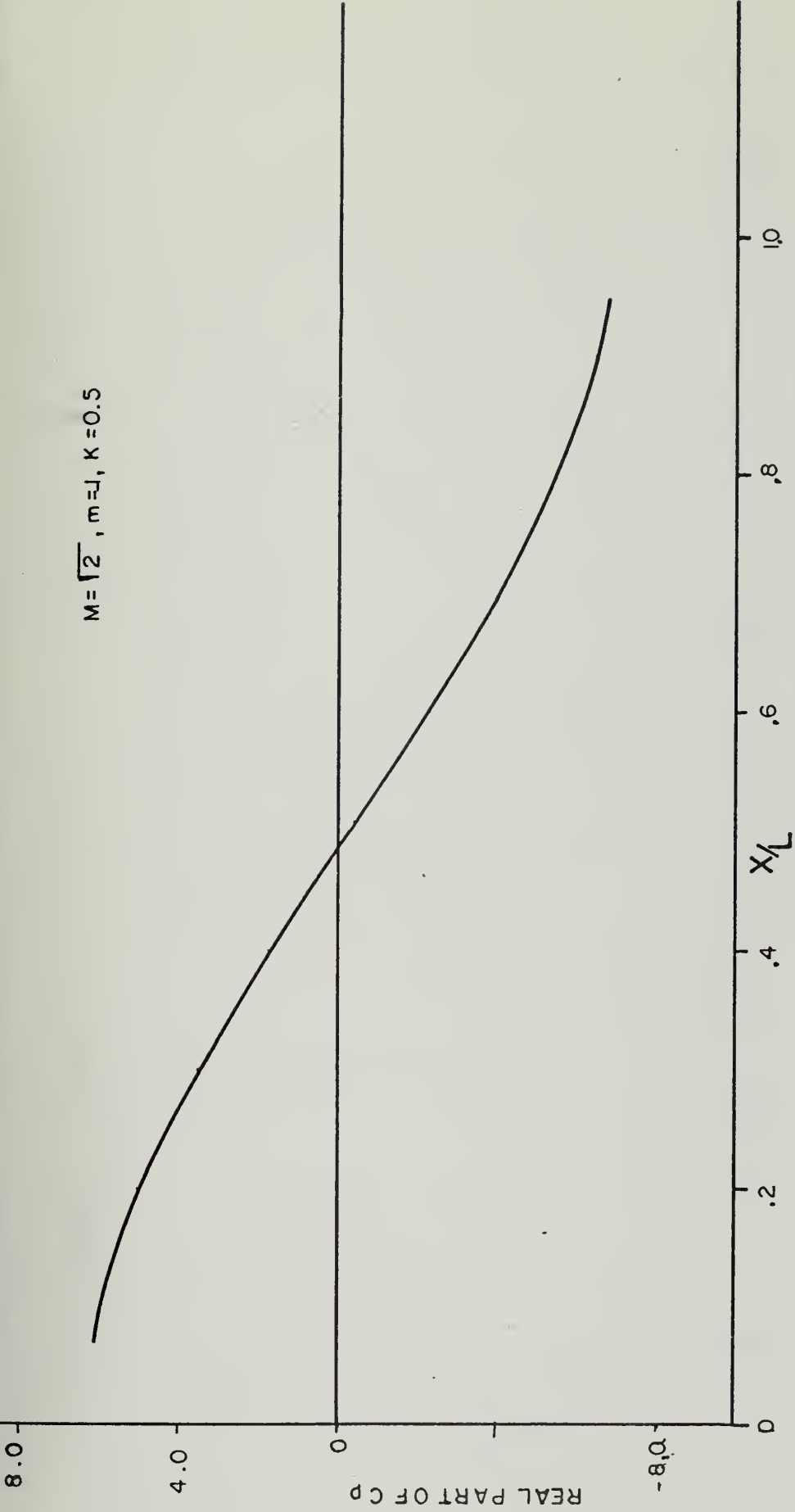

FIGURE 9

REAL PART OF  $C_p$  FOR A VIBRATING TWO-DIMENSIONAL FLAT PANEL  
METHOD OF SINGULARITIES





$$M = \sqrt{2}, m = 1, K = 0.5$$

.4

.3

.2

.1

IMAGINARY PART OF  $C_p$

0

.2

.4

.6

.8

1.0

X/L

FIGURE 10

IMAGINARY PART OF  $C_p$  FOR A VIBRATING TWO-DIMENSIONAL FLAT PANEL  
METHOD OF SINGULARITIES



$$M = \sqrt{2}, m = 1, K = 0.5$$

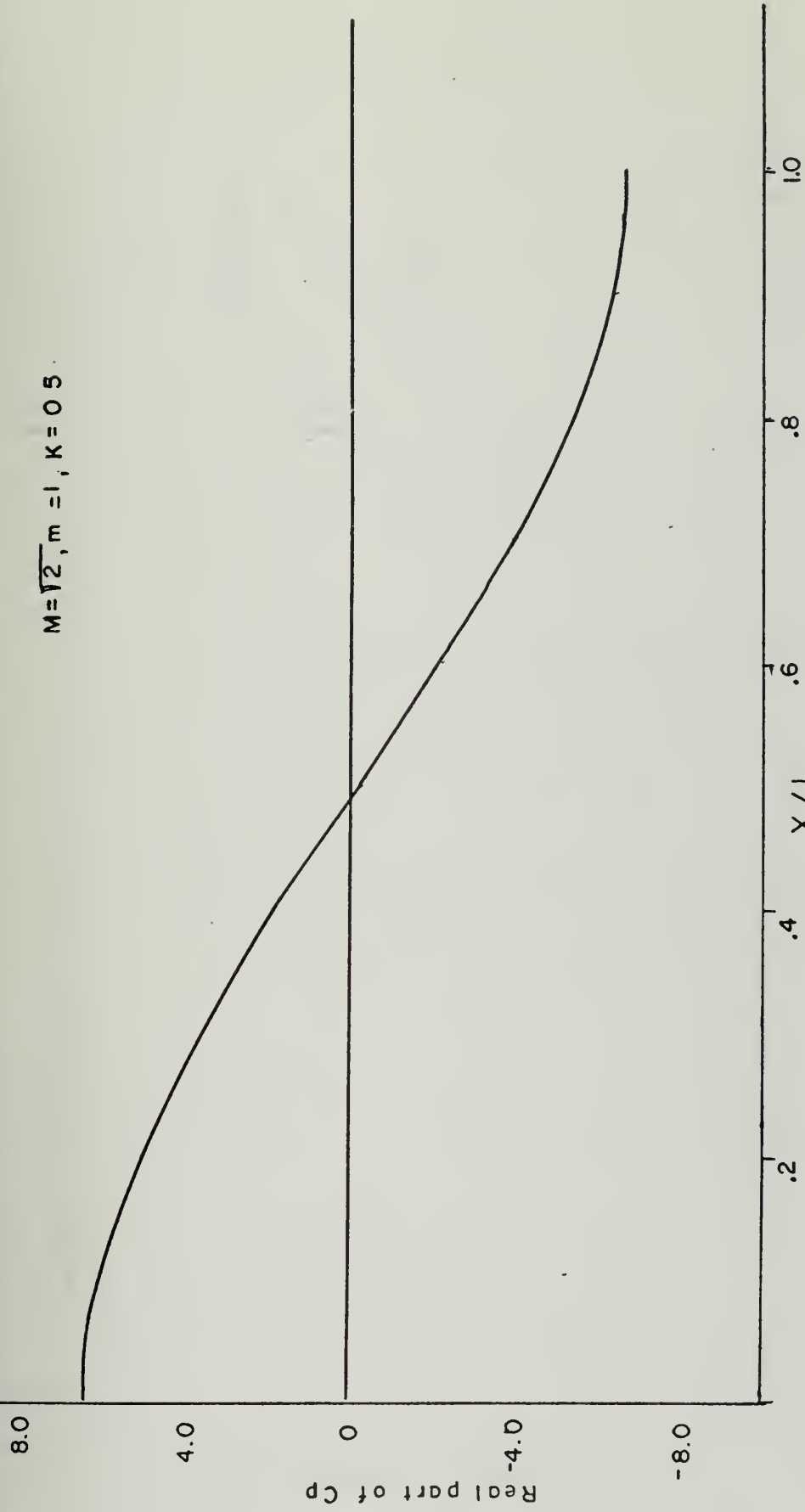

FIGURE 11

REAL PART OF  $C_p$  FOR A VIBRATING TWO-DIMENSIONAL FLAT PANEL

METHOD OF CHARACTERISTICS



$$M = \sqrt{2}, m = 1, K = 0.5$$

IMAGINARY PART OF  $C_p$

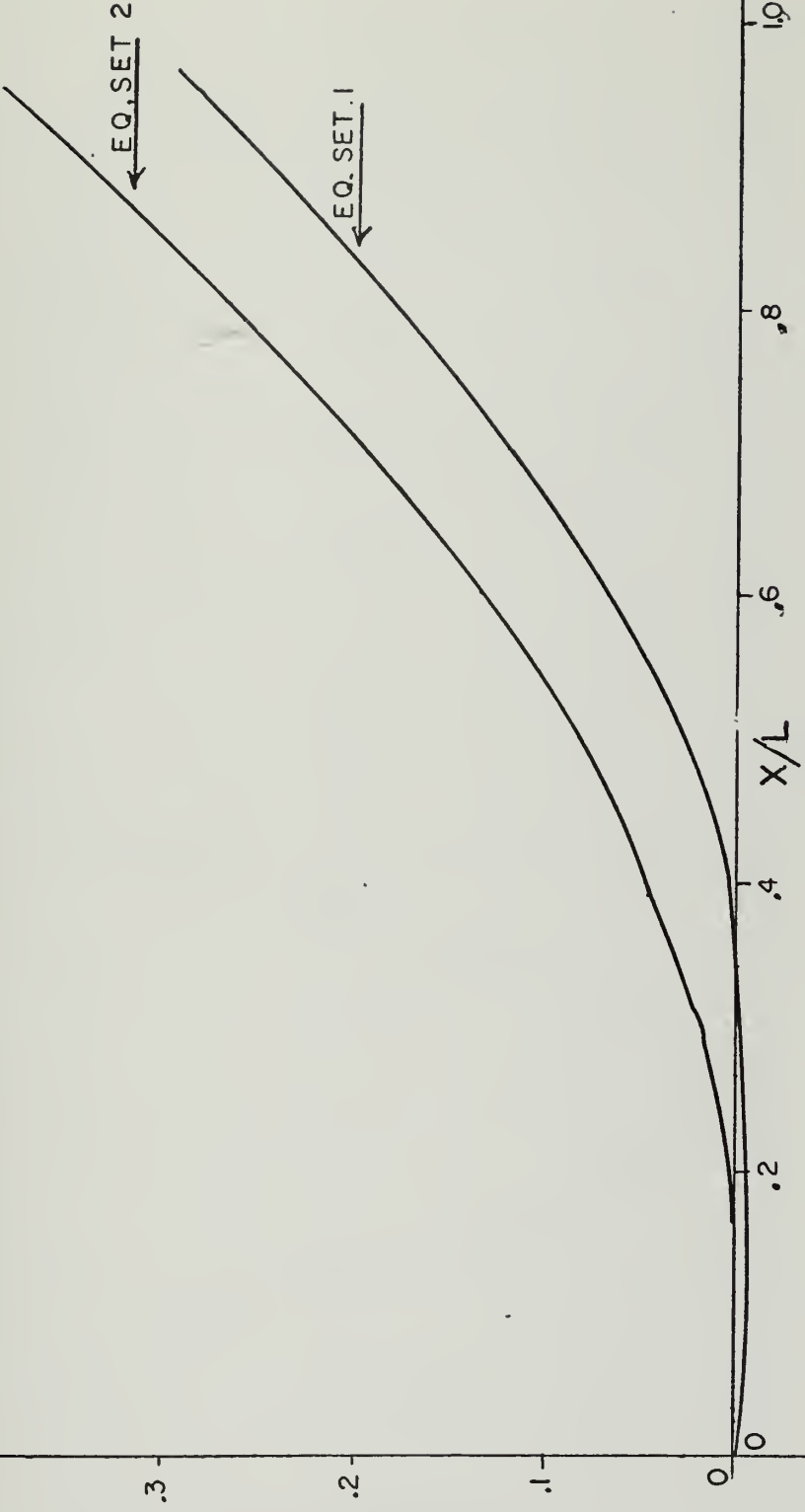
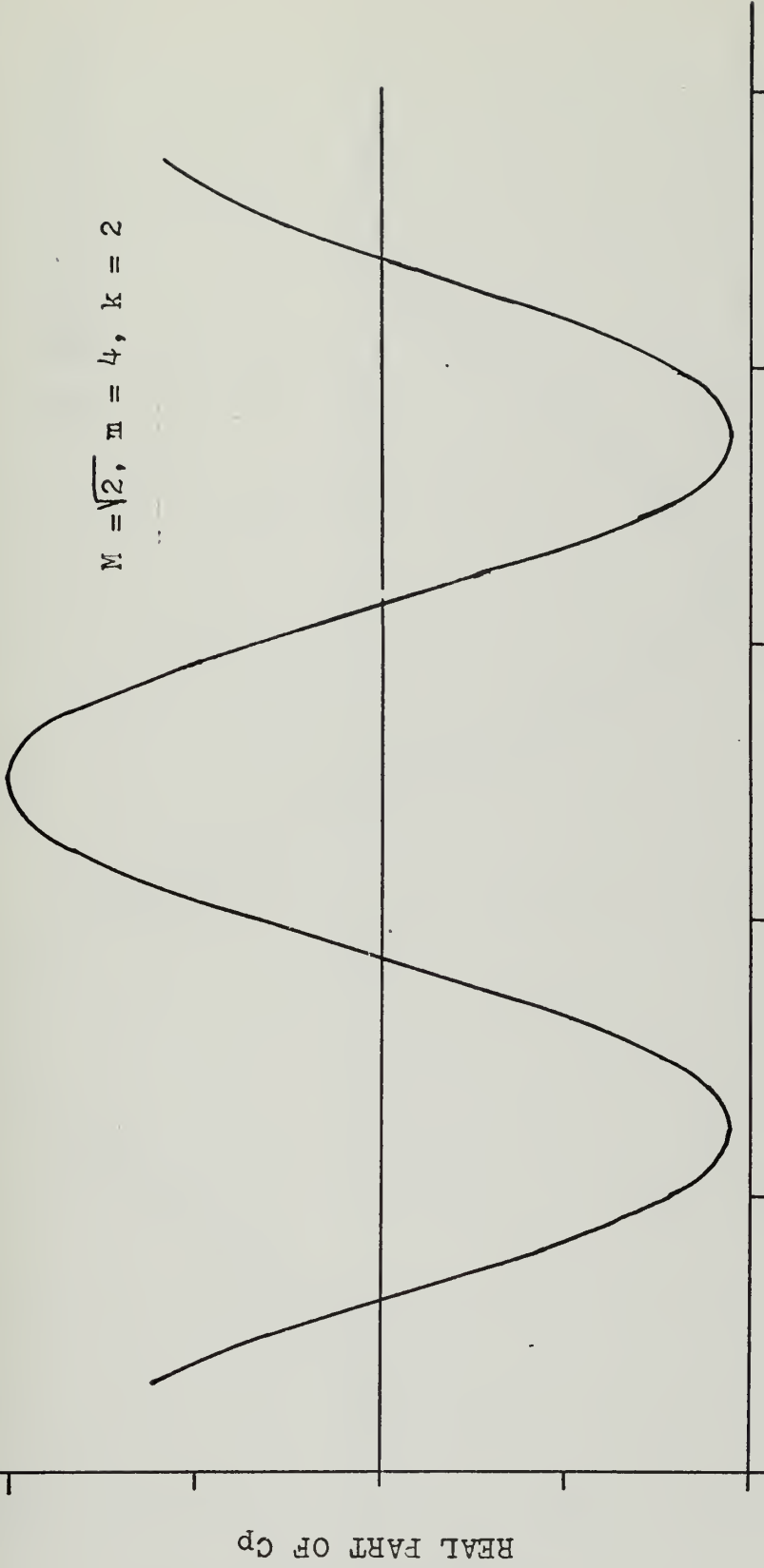

FIGURE 12

IMAGINARY PART OF  $C_p$  FOR A VIBRATING TWO-DIMENSIONAL FLAT PANEL  
METHOD OF CHARACTERISTICS



$$M = \sqrt{2}, \quad \pi = 4, \quad k = 2$$



$X/L$

FIGURE 13

REAL PART OF  $C_p$  FOR A VIBRATING TWO-DIMENSIONAL FLAT PANEL

METHOD OF SINGULARITIES





$$M = \sqrt{2}, m = 4, K = 2$$

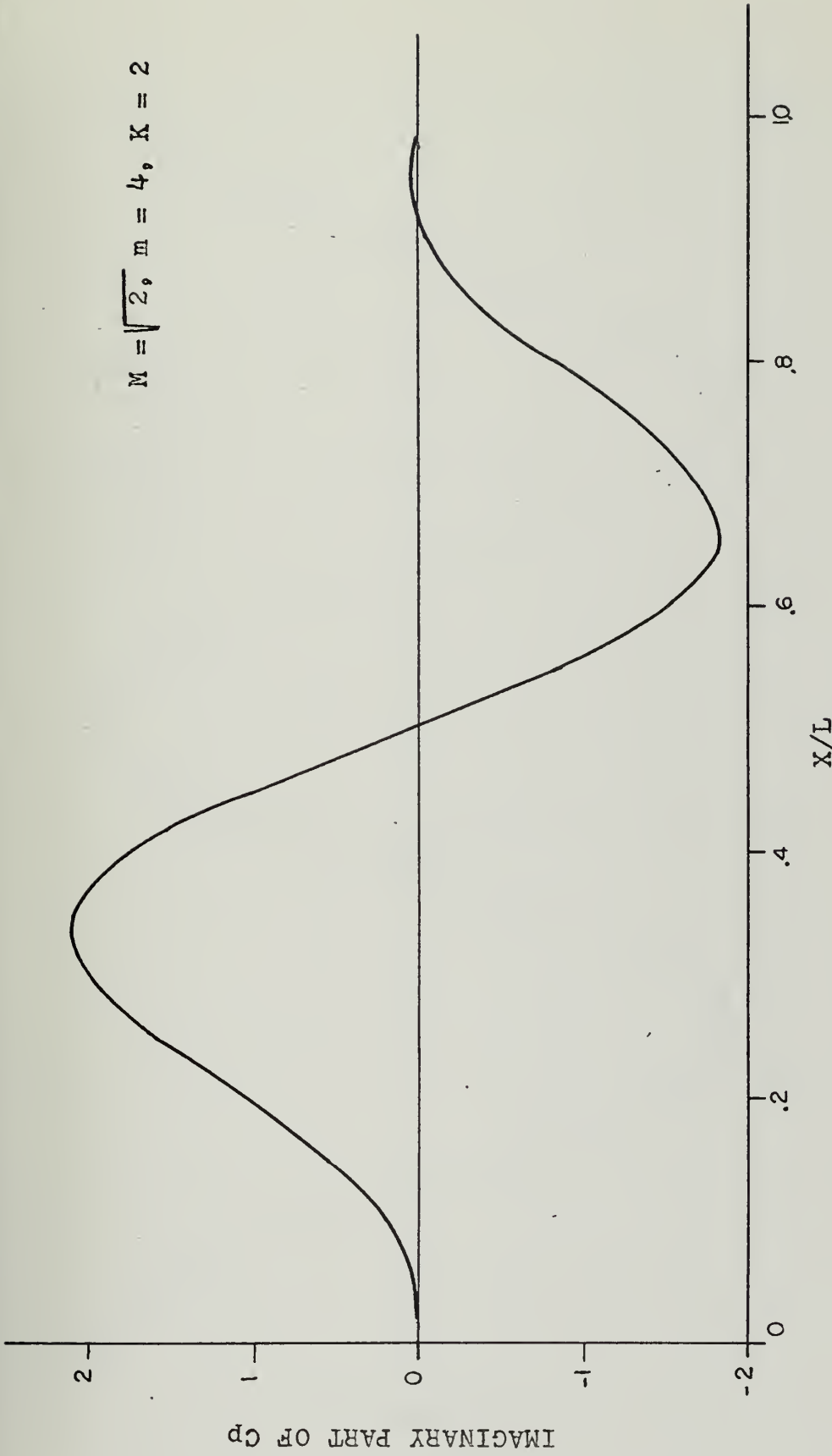

FIGURE 14

IMAGINARY PART OF  $C_p$  FOR A VIBRATING TWO-DIMENSIONAL FLAT PANEL

METHOD OF SINGULARITIES



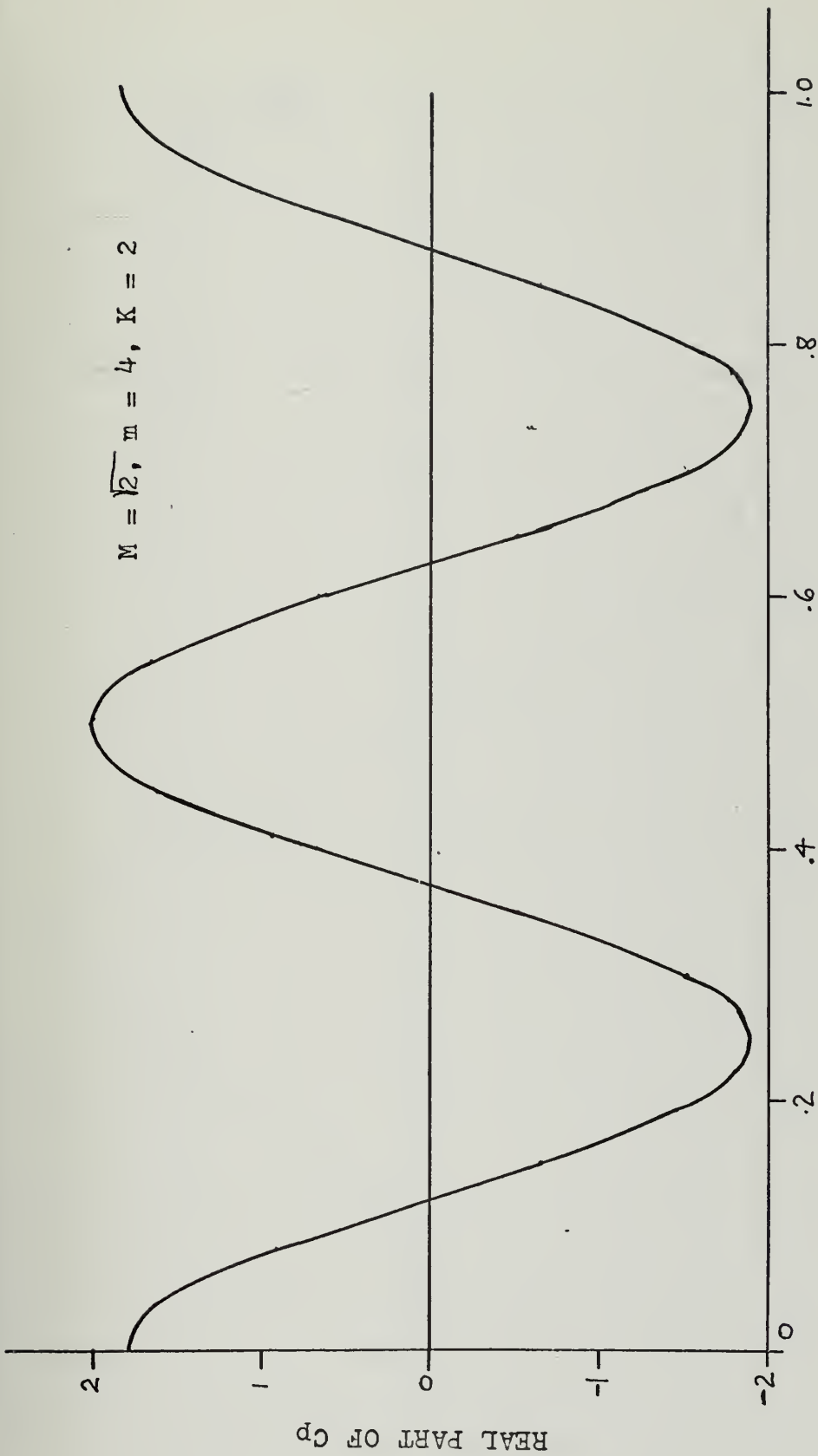

FIGURE 15  
 REAL PART OF  $C_p$  FOR A VIBRATING TWO-DIMENSIONAL FLAT PANEL  
 METHOD OF CHARACTERISTICS



$$M = \sqrt{2}, m = 4, K = 2$$

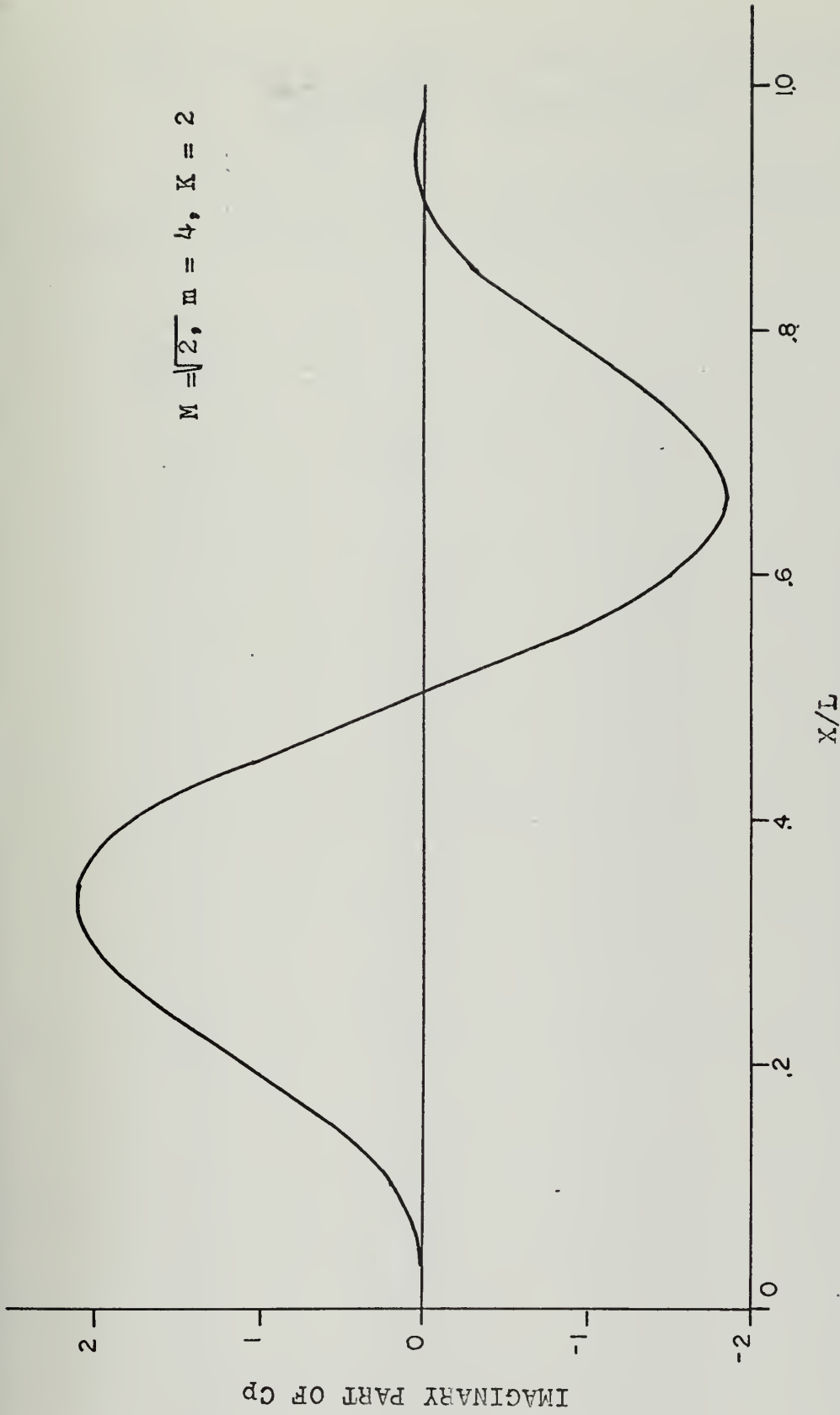

FIGURE 16

IMAGINARY PART OF  $C_p$  FOR A VIBRATING TWO-DIMENSIONAL FLAT PANEL

METHOD OF CHARACTERISTICS



COEFFICIENT OF PRESSURE COMPUTER OUTPUT LISTING

FOR CASE OF VIBRATING SHELL

$M = 3.5$ ,  $m = 3$ ,  $K = 0$ ,  $r = 0.20$  and  $n = 0, 1, 3$ ,

where  $L$  is divided into 120 grid points.

| <u>Grid Point</u> | <u>n = 0</u> | <u>n = 4</u> | <u>n = 8</u> |
|-------------------|--------------|--------------|--------------|
| 1.                | 5.6198       | 5.6198       | 5.6198       |
| 2.                | 5.5677       | 5.5538       | 5.5642       |
| 3.                | 5.4813       | 5.4266       | 5.4676       |
| 4.                | 5.3613       | 5.2396       | 5.3307       |
| 5.                | 5.2083       | 4.9950       | 5.1546       |
| 6.                | 5.0233       | 4.6954       | 4.9404       |
| 7.                | 4.8075       | 4.3440       | 4.6897       |
| 8.                | 4.5621       | 3.9444       | 4.4041       |
| 9.                | 4.2887       | 3.5007       | 4.0857       |
| 10.               | 3.9890       | 3.0172       | 3.7366       |
| 11.               | 3.6647       | 2.4988       | 3.3591       |
| 12.               | 3.3180       | 1.9504       | 2.9559       |
| 13.               | 2.9509       | 1.3775       | 2.5295       |
| 14.               | 2.5657       | 0.7855       | 2.0828       |
| 15.               | 2.1648       | 0.1801       | 1.6188       |
| 16.               | 1.7507       | -0.4329      | 1.1407       |
| 17.               | 1.3258       | -1.0477      | 0.6515       |
| 18.               | 0.8929       | -1.6586      | 0.1546       |
| 19.               | 0.4546       | -2.2597      | -0.3467      |
| 20.               | 0.0136       | -2.8453      | -0.8492      |
| 21.               | -0.4273      | -3.4100      | -1.3495      |
| 22.               | -0.8656      | -3.9435      | -1.8442      |
| 23.               | -1.2985      | -4.4557      | -2.3301      |
| 24.               | -1.7232      | -4.9267      | -2.8040      |
| 25.               | -2.1373      | -5.3572      | -3.2626      |
| 26.               | -2.5380      | -5.7431      | -3.7028      |
| 27.               | -2.9230      | -6.0806      | -4.1218      |
| 28.               | -3.2899      | -6.3665      | -4.5167      |
| 29.               | -3.6365      | -6.5980      | -4.8848      |
| 30.               | -3.9605      | -6.7726      | -5.2237      |
| 31.               | -4.2600      | -6.8886      | -5.5309      |
| 32.               | -4.5331      | -6.9446      | -5.8044      |
| 33.               | -4.7782      | -6.9398      | -6.0423      |
| 34.               | -4.9938      | -6.8738      | -6.2428      |
| 35.               | -5.1785      | -6.7468      | -6.4046      |
| 36.               | -5.3312      | -6.5595      | -6.5263      |
| 37.               | -5.4509      | -6.3132      | -6.6071      |
| 38.               | -5.5369      | -6.0095      | -6.6462      |
| 39.               | -5.5887      | -5.6507      | -6.6432      |





| <u>Grid<br/>Point</u> | <u>n = 0</u> | <u>n = 4</u> | <u>n = 8</u> |
|-----------------------|--------------|--------------|--------------|
| 40.                   | -5.6059      | -6.5979      | -5.2394      |
| 41.                   | -5.5885      | -6.5104      | -4.7787      |
| 42.                   | -5.5366      | -6.3810      | -4.2721      |
| 43.                   | -5.4504      | -6.2105      | -3.7235      |
| 44.                   | -5.3305      | -5.9996      | -3.1371      |
| 45.                   | -5.1777      | -5.7495      | -2.5175      |
| 46.                   | -4.9929      | -5.4616      | -1.8695      |
| 47.                   | -4.7773      | -5.1375      | -1.1981      |
| 48.                   | -4.5320      | -4.7791      | -0.5086      |
| 49.                   | -4.2588      | -4.3884      | -0.1934      |
| 50.                   | -3.9592      | -3.9678      | -0.9027      |
| 51.                   | -3.6351      | -3.5196      | -1.6137      |
| 52.                   | -3.2886      | -3.0466      | -2.3205      |
| 53.                   | -2.9216      | -2.5516      | -3.0178      |
| 54.                   | -2.5366      | -2.0375      | -3.7000      |
| 55.                   | -2.1359      | -1.5074      | -4.3616      |
| 56.                   | -1.7219      | -0.9644      | -4.9975      |
| 57.                   | -1.2972      | -0.4119      | -5.6025      |
| 58.                   | -0.8645      | 0.1467       | -6.1719      |
| 59.                   | -0.4263      | 0.7082       | -6.7010      |
| 60.                   | 0.0145       | 1.2692       | -7.1856      |
| 61.                   | 0.4554       | 1.8261       | 7.6218       |
| 62.                   | 0.8935       | 2.3757       | 8.0060       |
| 63.                   | 1.3262       | 2.9145       | 8.3350       |
| 64.                   | 1.7508       | 3.4393       | 8.6062       |
| 65.                   | 2.1647       | 3.9467       | 8.8171       |
| 66.                   | 2.5653       | 4.4338       | 8.9659       |
| 67.                   | 2.9502       | 4.8975       | 9.0512       |
| 68.                   | 3.3170       | 5.3350       | 9.0720       |
| 69.                   | 3.6633       | 5.7435       | 9.0280       |
| 70.                   | 3.9872       | 6.1205       | 8.9191       |
| 71.                   | 4.2866       | 6.4636       | 8.7458       |
| 72.                   | 4.5596       | 6.7708       | 8.5092       |
| 73.                   | 4.8046       | 7.0400       | 8.2107       |
| 74.                   | 5.0200       | 7.2697       | 7.8522       |
| 75.                   | 5.2046       | 7.4582       | 7.4361       |
| 76.                   | 5.3571       | 7.6045       | 6.9652       |
| 77.                   | 5.4767       | 7.7075       | 6.4427       |
| 78.                   | 5.5626       | 7.7666       | 5.8721       |
| 79.                   | 5.6142       | 7.7813       | 5.2573       |
| 80.                   | 5.6313       | 7.7514       | 4.6027       |
| 81.                   | 5.6138       | 7.6771       | 3.9126       |
| 82.                   | 5.5617       | 7.5588       | 3.1920       |
| 83.                   | 5.4755       | 7.3971       | 2.4459       |
| 84.                   | 5.3555       | 7.1929       | 1.6793       |
| 85.                   | 5.2025       | 6.9474       | 0.8978       |



| <u>Grid Point</u> | <u>n = 0</u> | <u>n = 4</u> | <u>n = 8</u> |
|-------------------|--------------|--------------|--------------|
| 86.               | 5.0176       | 6.6619       | 0.1068       |
| 87.               | 4.8018       | 6.3383       | -0.6882      |
| 88.               | 4.5565       | 5.9783       | -1.4817      |
| 89.               | 4.2831       | 5.5841       | -2.2681      |
| 90.               | 3.9834       | 5.1580       | -3.0419      |
| 91.               | 3.6592       | 4.7026       | -3.7977      |
| 92.               | 3.3125       | 4.2205       | -4.5302      |
| 93.               | 2.9455       | 3.7146       | -5.2342      |
| 94.               | 2.5604       | 3.1879       | -5.9048      |
| 95.               | 2.1595       | 2.6436       | -6.5374      |
| 96.               | 1.7454       | 2.0848       | -7.1275      |
| 97.               | 1.3206       | 1.5150       | -7.6710      |
| 98.               | 0.8878       | 0.9376       | -8.1640      |
| 99.               | 0.4495       | 0.3559       | -8.6031      |
| 100.              | 0.0085       | -0.2264      | -8.9853      |
| 101.              | -0.4324      | -0.8061      | -9.3078      |
| 102.              | -0.8706      | -1.3795      | -9.5684      |
| 103.              | -1.3034      | -1.9434      | -9.7652      |
| 104.              | -1.7282      | -2.4942      | -9.8968      |
| 105.              | -2.1421      | -3.0288      | -9.9623      |
| 106.              | -2.5429      | -3.5439      | -9.9611      |
| 107.              | -2.9278      | -4.0364      | -9.8932      |
| 108.              | -3.2947      | -4.5035      | -9.7591      |
| 109.              | -3.6412      | -4.9423      | -9.5595      |
| 110.              | -3.9652      | -5.3503      | -9.2957      |
| 111.              | -4.2646      | -5.7250      | -8.9696      |
| 112.              | -4.5378      | -6.0642      | -8.5833      |
| 113.              | -4.7828      | -6.3660      | -8.1393      |
| 114.              | -4.9984      | -6.6285      | -7.6406      |
| 115.              | -5.1830      | -6.8502      | -7.0906      |
| 116.              | -5.3356      | -7.0299      | -6.4928      |
| 117.              | -5.4553      | -7.1665      | -5.8513      |
| 118.              | -5.5413      | -7.2593      | -5.1703      |
| 119.              | -5.5931      | -7.3078      | -4.4545      |
| 120.              | -5.6103      | -7.3117      | -3.7084      |



## VI. SUMMARY AND CONCLUSIONS

A linearized method of characteristics procedure was developed to compute supersonic flow past vibrating panels and shells. Good agreement was obtained when comparing with previous results by Nelson and Cunningham [Ref. 4] and Anderson [Ref. 5], who used quite different approaches to this problem.

However, more work needs to be done to further verify the cylindrical shell computations. In particular, the computations of the generalized aerodynamic forces presented by Dowell and Widnall [Ref. 6] should be verified. For this purpose the limiting case of vanishing shell radius (slender body theory) must be studied. This requires a reformulation of the flow boundary condition.

Also, it should be noted that the characteristics method allows the incorporation of quite arbitrary vibration modes (not restricted to sinusoidal modes) and hence should prove to be a quite versatile tool for aeroelastic analyses in the supersonic flow regime.



APPENDIX A: VIBRATING PANEL COMPUTER PROGRAM

'LINEARIZED METHOD OF CHARACTERISTICS'  
FOR SUPERSONIC FLOW PAST A VIBRATING PANEL

DEFINITION OF TERMS USED

MACH IS FREE STREAM MACH NUMBER  
 K IS REDUCED DIMENSIONLESS FREQUENCY  
 MFREQ IS THE AXIAL MODE OF THE CYLINDER  
 MANGL IS THE MACH ANGLE OF THE GRID  
 FINGRD IS THE FINENESS OF THE MACH LINES  
 DELTAS IS THE STEP SIZE ALONG THE MACH LINES  
 ISWITCH IS THE SWITCH VARIABLE FOR CHOOSING THE LINE ON WHICH  
 TO WORK  
 JSWITCH IS OPPOSITE OF ISWITCH. IF ISWITCH=1, JSWITCH=2 OR VICE-VERSA.  
 XLNGL IS THE LENGHT OF INITIAL MACH LINE  
 MLNGL IS THE MAX NUMBER OF PTS. ON THE INITIAL MACH LINE.  
 QPHI IS THE VELOCITY POTENTIAL  
 PHK IS THE DERIVATIVE OF THE VEL. POT. ALONG THE LEFT RUNNING  
 CHARACTERISTIC  
 PHI IS THE DERIVATIVE OF THE VEL. POT. ALONG THE RIGHT RUNNING  
 CHARACTERISTIC  
 PX IS THE DERIVATIVE OF THE VEL. POT. IN THE X DIRECTION  
 CP IS THE DERIVATIVE OF THE VEL. POT. IN THE R DIRECTION  
 REALCP IS THE COMBINED REAL PART OF CP  
 AMAGCP IS THE IMAGINARY PART OF CP

RUN IN DOUBLE PRECISION

IMPLICIT REAL\*8 (A-H,O-Z,\$)  
 DIMENSION DATE(3), YYY(90)  
 COMMON DPHI1,DPHIK,PHI(400,2),PHK(400,2),QPHI(400,2),IPHI1,IPHI2,  
 4 IKM,IKW,PARM,W,I,I,REALCP(400),CP(400),AMAGCP(400),  
 1 MACH,K,MANGL,RADIUS,DELTA,XLENGI,BETA,DSTSTR,HDSSTR,TRNGLH,  
 2 X(400,2),R(400,2),NFREQ,FINGRD,ISWITCH,JSWITCH,I LINE,MLINE,JLINE,  
 3 MFREQ,IHAVEP,KOUNT  
 INTEGER FINGRD  
 REAL\*8 MACH,MANGL,K  
 COMPLEX\*16  
 1 DPHI1,DPHIK,PHI,IKM,CP,PX ,IPHI1,IPHI2,IKW,PHK,II,QPHI  
 1 ,PR

CC

C C





```

C      PRINT NAME OF PROGRAM AND DATE OF RUN
C      READ (5,10) DATE
10     FORMAT (3A4)
11     FORMAT (1H1///.40X,'LINEARIZED METHOD OF CHARACTERISTICS'//40X,
1     'FOR SUPERSONIC FLOW PAST A VIBRATING CYLINDRICAL SHELL'//10X,
2     'DATE OF RUN-',3A4//)
C      WRITE (6,11) DATE
C
C      READ INPUT
C      READ (5,1) FINGRD , NUMRUN, MFREQ
200    READ (5,2) MACH, K
1     FORMAT (3I5)
2     FORMAT (2F10.4)
C
C      COMPUTE CONSTANTS
C      II=(0.0,1.0)
BETA=DSQRT(MACH**2-1.0)
MANGL=DARSIN(1.0/MACH)
XLNGT=1./(2.*DCOS(MANGL))
HEIGHT=DSIN(MANGL)*XLNGT
DELTA=XLNGT/FINGRD
DSTSTR=DELTA*S*DCOS(MANGL)*2.0
HDSTR=5*DSTSTR
MLINE=FINGRD
TRNGLH=HDSTR*DTAN(MANGL)
C
C      DO 31 KK=1,400
31     CP(KK)=(0.,0.)
C      CONTINUE
C
C      SET COUNTERS
C      ISWITCH=2
20     JSWITCH=1
C      IHAVEP=1
C
C      COMPUTE INITIAL VALUES
C      I=IHAVEP
C      QPHI(I,JSWITCH)=(0.,0.)
C      PHK(I,JSWITCH)=(0.,0.)
C      X(IHAVEP,JSWITCH)=0.0
C      R(IHAVEP,JSWITCH)=0

```



```

PI=3.141592654
PARW=MFREQ*PI*DCOS(MFREQ*PI*X(IHAVEP,JSWITCH) )
QR=PARW
PHI(I,JSWITCH)=-2*QR/MACH
WRITE OUT INPUT
C C
12 WRITE (6,12) MACH,K,FINGRD,MFREQ
FORMAT (1H0,20X,'FREESTREAM MACH NUMBER =',F9.6//20X,'REDUCED FREQ
1 =',F9.5//20X,'GRID FINENESS IS =',
2 I2,/,',20X,'AXIAL MODE NO. M =',I2)
C C
WRITE INITIAL VALUES
WRITE (6,57) QPHI(1,1),PHI(1,1),PHK(1,1),X(1,1),R(1,1),PARW
FORMAT (/,/0.,20X,'INITIAL VALUE OF QPHI =',2E10.5,5X,'PHI =',
1 2E10.4,3X,'PHK =',2E10.4,/,',20X,'X =',E10.3,2X,'R =',E8.3
2,'PARW =',E10.3,/,/)
C C
SET COUNTER UP FOR EACH LINE
KOUNT=2
WRITE (6,59) KOUNT
FORMAT (/,',KOUNT =',I5)
C C
COMPXR COMPUTES THE VALUE FOR X AND R GIVEN IHAVEP,ISWITCH
CALL COMPXR
PI=3.141592654
PARW=MFREQ*PI*DCOS(MFREQ*PI*X(IHAVEP,ISWITCH) )
W=DSIN(MFREQ*Q*PI*X(IHAVEP,ISWITCH))
XKM=(K*MACH)/BETA
IKM=I*XKM
XKW=K*W
IKW=I*XKW
IF (KOUNT.GT.12) GO TO 1001
WRITE (6,58) PARW,W,IKM,IKW
FORMAT (/,',20X,'CONSTANTS AT NEW POINT',/,',20X,'PARW =',
1 E16.5,3X,'W =',E10.5,/,',20X,'IKM & IKW =',2(E10.5,5X))
C C
THE PROGRAM NOW GOES TO 30 IF POINT IS ON INITIAL MACH LINE.
C C
1001 IF (IHAVEP.EQ.1) GO TO 30
C C
TEST IF WE ARE AT A PANEL PT.
C C
IF (IHAVEP.EQ.KOUNT) GO TO 40
GO TO 60

```



```

C 30 CALL MACHLN
      GO TO 50
C 40 CALL PANPNT
      GO TO 50
C 60 CALL GENFPT
      C
      C WRITE OUT PUT
      C
      C 50 IF (KOUNT.GT.12) GO TO 1000
      A=IHAVEP
      B=ISWITCH
      PX=(MACH/2.0)*(PHK(A,B)+PHI(A,B))
      PR=(MACH/2.0)*(PHK(A,B)-PHI(A,B))
      WRITE (6,61) IHAVEP,KOUNT,PX,PR
      FORMAT (10,1,IHAVEP FOR RUN =,I3,3X,KOUNT =,I3,
12X,PX =,2F15.8,5X,PR =,2F15.8)
      WRITE (6,52) X(A,B),R(A,B),PHI(A,B),PHK(A,B),QPHI(A,B)
      FORMAT (1,1X,2F14.5,3X,2F15.8,1X,2F15.8//)
      C
      C 1000 IF (IHAVEP.EQ.KOUNT) GO TO 25
      GO TO 35
      C
      C INCREMENT FOR NEXT LINES
      C
      C 25 IF (ISWITCH.EQ.1.) GO TO 103
      ISWITCH=1
      JSWITCH=2
      IHAVEP=1
      GO TO 108
      C
      C SWITCH LINES HERE SO FIRST OLD (ILINE) BECOMES LAST NEW ONE
      C ZERO LINE COUNTER
      C
      C 103 ISWITCH=2
      JSWITCH=1
      IHAVEP=1
      GO TO 108
      C
      C AT 35 INCREMENT ALONG PRESENT LINE
      C
      C 35 IHAVEP=IHAVEP+1
      GO TO 104

```



```

108 KOUNT=KOUNT+1
    IF ((KOUNT-1).GT.MLINE) GO TO 101
    GO TO 100
101 WRITE (6,39)
39  FORMAT (//,,',',10X,'CP.')
    DO 37 KK=1,MLINE
36  YY(KK)=KK
37  WRITE (6,36) CP(KK)
    FORMAT (',',10X,2F18.8)
    CONTINUE
    NNN=MLINE
    MMM=0
    IF (NUMRUN.EQ.2) GO TO 200
    STOP
    END

```

C C





```

SUBROUTINE COMPR (A-H,O-Z,$)
IMPLICIT REAL*8 (A-H,O-Z,$)
REAL*8 MACH,MANGL,K,KW
CC
CC
COMPUTES THE X AND R CORRINATES
COMMON DPHI,DPHIK,PHI(400,2),PHK(400,2),QPHI(400,2),IPHI1,IPHI2,
4 IKM,IKW,PARW,W,I,REALCP(400),CP(400),AMAGCP(400),
1 MACH,K,MANGL,RADIUS,DELTA,DELTA,DELTA,DSTSTR,HDSTRL,TRNGLH,
2 X(400,2),R(400,2),NPREO,FINGRD,ISWITCH,JSWITCH,ILINE,MLINE,JLINE,
3 MFREQ,IHAVEP
COMPLEX*16
1 DPHI,DPHIK,PHI,IKM,CP,PX,IPHI1,IPHI2,IKW,PHK,I,OPHI
INTEG FINGRD
CC
CC
TEST FOR POINT ON MACH LINE
IF (IHAVEP.EQ.1) GO TO 10
I=IHAVEP-1
J=IHAVEP-1
X(I,ISWITCH)=X(J,ISWITCH)+HDSTRL-TRNGLH
R(I,ISWITCH)=R(J,ISWITCH)
GO TO 6
I=IHAVEP
X(I,ISWITCH)=X(I,ISWITCH)+HDSTRL
R(I,ISWITCH)=R(I,ISWITCH)+TRNGLH
RETURN
END
10
6
CC
CC

```



```

SUBROUTINE MACHLN (A-H,O-Z,$)
IMPLICIT REAL*8 (A-H,O-Z,$)
COMMON DPHI,DPHIK,PHI(400,2),PHK(400,2),QPHI(400,2),IPHI1,IPHI2,
IKM,IKW,MACH,K,MANGL,R(400,2),NFREQ,IPHI,DPHIK,PHI,IKM,CP,PX,IPHI1,IPHI2,IKW,PHK,II,QPHI
1 X(400,2),R(400,2),NFREQ,IPHI,DPHIK,PHI,IKM,CP,PX,IPHI1,IPHI2,IKW,PHK,II,QPHI
2 MFREQ,IPHI,DPHIK,PHI,IKM,CP,PX,IPHI1,IPHI2,IKW,PHK,II,QPHI
3 REAL*8 MACH,MANGL,K,KW
COMPLEX*16
1 A,B,C,D,DPHI,DPHIK,PHI,IKM,CP,PX,IPHI1,IPHI2,IKW,PHK,II,QPHI
2 INTEGER FINGRD
I=IHAVEP
PHK(I,ISWTC)= (0.,0.)
A=1+((II*K*MACH)/(2.*BETA))*DELTAS
PHI(I,ISWTC)=PHI(I,JSWTC)*((I-((II*K*MACH)/(2.*BETA))*DELTAS)/A)
QPHI(I,ISWTC)=(0.,0.)
WRITE (6,1) QPHI(I,ISWTC),PHI(I,ISWTC),PHK(I,ISWTC),A
1 FORMAT ('0.',LEAVING MACHLN QPHI =',2E15.5,5X,PHI =',2E15.5,
/5X,PHK =',2E15.5,5X,'A =',2E16.8)
1 RETURN
END

```

1

C



```

SUBROUTINE GENFPT
  IMPLICIT REAL*8 (A-H,O-Z,$)
  C
  C
  GENFPT COMPUTES PHI'S AT A GENERAL FIELD POINT
  COMMON DPHI1,DPHIK,PHI(400,2),PHK(400,2),QPHI(400,2),IPHI1,IPHI2,
  4 IKM,IKW,PARW,W,II,REALCP(400),CP(400),AMAGCP(400),
  1 MACH,K,MANGL,RADIUS,DELTA,XLENGT,BETA,DSTSTR,HDSTR,IRNGLH,
  2 X(400,2),R(400,2),NREQ,FINGRD,ISWTC,HJ,SWTC,ILINE,MLINE,ILINE,
  3 MREQ,IHAVEP,KOUNT
  REAL*8 MACH,MANGL,K,KW
  COMPLEX*16
  1A,B,C,D,DPHI1,DPHIK,PHI,IKM,CP,PX,IPHI1,IPHI2,IKW,PHK,II,QPHI
  INTEGER FINGRD
  C
  I=IHAVEP
  J=IHAVEP - 1
  C
  A=1+((I*I*MACH)/(2.*BETA))*DELTA
  B=-((K**2/4.0)*DELTA**2+((I*I*MACH)/(2.*BETA))*DELTA
  C=PHK(J,ISWTC)* (1-((I*I*MACH)/(2.*BETA))*DELTA)+PHI(J,ISWTC)*
  1 ((K**2/4.0)*DELTA**2-((I*I*MACH)/(2.*BETA))*DELTA)+K**2*
  2 DELTA*QPHI(J,ISWTC)
  D=PHI(I,JSWTC)* (1-((I*I*MACH)/(2.*BETA))*DELTA)+PHK(I,JSWTC)*
  1 ((K**2/4.0)*DELTA**2-((I*I*MACH)/(2.*BETA))*DELTA)+K**2*
  2 DELTA*QPHI(I,JSWTC)/(A**2-B**2)
  PHK(I,ISWTC)=(D*A-C*B)/(A**2-B**2)
  PHI(I,ISWTC)=(D*A-C*B)/(A**2-B**2)
  IPHI1=QPHI(I,JSWTC)+0.5*(PHK(I,JSWTC)+PHK(I,ISWTC))*DELTA
  IPHI2=QPHI(J,ISWTC)+0.5*(PHI(J,ISWTC)+PHI(I,ISWTC))*DELTA
  C
  AVERAGE THE TWO
  C
  C
  QPHI(I,ISWTC)=0.5*(IPHI1+IPHI2)
  IF (KOUNT.GT.12) GO TO 15
  WRITE (6,10) A,B,C,D
  10 FORMAT (' ',3X,'A =',2F16.8,5X,'B =',2F16.8, /
  15 ' ',5X,'C =',2F16.8,5X,'D =',2F16.8)
  RETURN
  END
  C

```



```

C
C
SUBROUTINE PANPNT
IMPLICIT REAL*8 (A-H,O-Z,$)

PANPNT COMPUTES THE VALUES OF PHI'S AND QPHI AT A PANEL POINT

COMMON DPHI,DPHIK,PHI(400,2),PHK(400,2),QPHI(400,2),IPHI1,IPHI2,
4 IKM,IKW,PARW,W,II,REALCP(400),CP(400),AMAGCP(400),
1 MACH,K,MANGL,RADIUS,DELTAS,XLENGT,BETA,DSISTR,HDSTRL,TRNGLH,
2 X(400,2),R(400,2),NFREQ,FINGRD,ISWITCH,JSWITCH,IILINE,MLINE,MLINE,
3 MFREQ,IHAVEP,KOUNT
REAL*8 MACH,MANGL,K,KW
COMPLEX*16
1 A,B,C,D,DPHI,DPHIK,PHI,IKM,CP,PX,IPHI1,IPHI2,IKW,PHK,II,QPHI
C INTEGER FINGRD

I=IHAVEP-1
J=IHAVEP-1
A=1+((II*K*MACH)/(2.*BETA))*DELTAS
B=-((K**2/4.0)*DELTAS**2+((II*K*MACH)/(2.*BETA))*DELTAS
C=PHK(J,ISWITCH)*((1-((II*K*MACH)/(2.*BETA))*DELTAS)*PHI(J,ISWITCH)*
1 ((K**2/4.0)*DELTAS**2-((II*K*MACH)/(2.*BETA))*DELTAS)+K**2*
2 DELTAS*QPHI(J,ISWITCH)
PHK(I,ISWITCH)=(C+B*(2.0/MACH))*(PARW+IKW)/(A+B)
PHI(I,ISWITCH)=(-A*(2.0/MACH))*((PARW+IKW)+C)/(A+B)

C
QPHI(I,ISWITCH)=QPHI(J,ISWITCH)+0.5*(PHI(J,ISWITCH)+PHI(I
1 ISWITCH))*DELTAS
PX=(MACH/(2.0*BETA))*((PHK(I,ISWITCH)+PHI(I,ISWITCH))
CP(KOUNT)=-2.0*(II*K*QPHI(I,ISWITCH)+PX)
AMAGCP(KOUNT)=AMAG(CP(KOUNT))
REALCP(KOUNT)=REAL(CP(KOUNT))
WRITE(6,1) QPHI(I,ISWITCH),PHI(I,ISWITCH),PHK(I,ISWITCH),C
1 FORMAT('0','LEAVING PANPNT QPHI =',2E15.5,5X,'PHI =',2E15.5,
U/5X,'PHK =',2E15.5,5X,'C =',2D16.8)
RETURN
END

```





APPENDIX B: VIBRATING SHELL COMPUTER PROGRAM

```

'LINEARIZED METHOD OF CHARACTERISTICS,
FOR SUPERSONIC FLOW PAST A VIBRATING CYLINDRICAL SHELL

DEFINITION OF TERMS USED

MACH IS FREE STREAM MACH NUMBER
K IS REDUCED DIMENSIONLESS FREQUENCY
NFREQ IS THE RADIAL MODE OF THE CYLINDER
MANGL I IS THE AXIAL MODE OF THE CYLINDER
MANGL II IS THE MACH ANGLE
FINGRD IS THE FINENESS OF THE GRID
RADIUS IS THE RADIUS OF THE CYLINDER
DELTAS IS THE STEP SIZE ALONG THE MACH LINES
ISWITCH IS THE SWITCH VARIABLE FOR CHOOSING THE LINE ON WHICH
TO WORK.
JSWITCH IS OPPOSITE OF ISWITCH. IF ISWITCH=1, JSWITCH=2 OR VICE-VERSA.
XLENGT IS THE LENGHT OF INITIAL MACH LINE
MLINE IS THE MAX NUMBER OF PTS. ON THE INITIAL MACH LINE.
QPHI IS THE VELOCITY POTENTIAL
PHK IS THE DERIVATIVE OF THE VEL. POT. ALONG THE LEFT RUNNING
CHARACTERISTIC
PHI IS THE DERIVATIVE OF THE VEL. POT. ALONG THE RIGHT RUNNING
CHARACTERISTIC
PX IS THE DERIVATIVE OF THE VEL. POT. IN THE X DIRECTION
PR IS THE DERIVATIVE OF THE VEL. POT. IN THE R DIRECTION
CP IS THE COEFFICIENT OF PRESSURE
REALCP IS THE REAL PART OF CP
AMAGCP IS THE IMAGINARY PART OF CP

RUN IN DOUBLE PRECISION

IMPLICIT REAL*8 (A-H,O-Z,$)
DIMENSION DATE(3),YYY(90)
COMMON DPHII,DPHIK,PHI(400,2),PHK(400,2),QPHI(400,2),IPHI1,IPHI2,
4 IKM,IKW,PARW,W,I,REALCP(400),CP(400),AMAGCP(400),
1 MACH,K,MANGL,RADIUS,DELTAS,XLENGT,BETA,DSTSTR,HDSTRL,TRNGLH,
2 X(400,2),R(400,2),NFREQ,FINGRD,ISWITCH,JSWITCH,ILINE,MLINE,JLINE,
3 MFREQ,IHAVEP,KOUNT

INTEGER FINGRD
REAL*8 MACH,MANGL,K
COMPLEX*16
1 DPHII,DPHIK,PHI,IKM,CP,PX,IPHI1,IPHI2,IKW,PHK,II,QPHI
1 ,PR

```

CC

C



```

C C C PRINT NAME OF PROGRAM AND DATE OF RUN
C C C
10 READ (5,10) DATE
11 FORMAT (3A4)
1,1 FOR SUPERSONIC FLOW PAST A VIBRATING CYLINDRICAL SHELL'//40X,
2,DATE OF RUN-',3A4'//)
WRITE (6,11) DATE

C C C READ INPUT
C C C
200 READ (5,1) FINGRD , NUMRUN, NFREQ, MFREQ, GRAPH
1 READ (5,2) MACH, K, RADIUS
2 FORMAT (5I5)
FORMAT (3F10.4)

C C C COMPUTE CONSTANTS
C C C
II=(0.0,1.0)
BETA=DSQRT(MACH**2-1.0)
MANGL=DARSIN(1.0/MACH)
XLENGT=DCOS(MANGL)
HEIGHT=DSIN(MANGL)*XLENGT
DELTA=XLENGT / FINGRD
DSTSTR=DELTA*DCOS(MANGL)*2.0
HDSSTR=.5*DSTSTR
MLINE=FINGRD
TRNGLH=HDSSTR*DTAN(MANGL)

C C C WRITE OUT INPUT
C C C
12 WRITE (6,12) MACH, K, NFREQ, FINGRD , RADIUS , MFREQ
FORMAT (1H0,10X,'FREESTREAM MACH NUMBER =',F9.6//10X,'REDUCED FREQ
1, F9.5//10X,'RAD MODE NO. N =',I2//10X,'GRID FINENESS IS =',
2, I2 //10X,'CYLINDER RADIUS IS =',F9.2//10X,'AXIAL MODE NO. M
3, I2)
DO 31 KK=1,400
CP(KK)=(0.,0.)
REALCP(KK)=(0.,0.)
AMAGCP(KK)=(0.,0.)
CONTINUE

C C C SET COUNTERS
C C C
20 ISWITCH=2

```



```

C
C
C
JSWITCH=1
IHAVEP=1

COMPUTE INITIAL VALUES

I=IHAVEP
QPHI(I,JSWITCH)=(0.,0.)
PHK(I,JSWITCH)=(0.,0.)
X(IHAVEP,JSWITCH)=0.0
R(IHAVEP,JSWITCH)=RADIUS
PI=3.141592654
PARW=MFREQ*PI*DCOS(MFREQ*PI*X(IHAVEP,JSWITCH) )
PHI(I,JSWITCH)=-2*PARW/MACH

C
C
C
WRITE INITIAL VALUES

WRITE (6,57) QPHI(1,1),PHI(1,1),PHK(1,1),X(1,1),R(1,1),PARW,QR
FORMAT (//,0,' INITIAL VALUE OF QPHI =',2E10.5,5X,'PHI =',2E15.5,
15X,'PHK =',2E10.5/5X,'X =',E10.4,5X,'R =',E10.4,10X,'PARW =',
1 E10.4,5X,'QR =',2E15.4//)

C
C
C
SET COUNTER UP FOR EACH LINE

KOUNT=2
WRITE (6,59) KOUNT
FORMAT (',',',',KOUNT =',I5)

C
C
C
COMPR COMPUTES THE VALUE FOR X AND R GIVEN IHAVEP, ISWITCH

CALL COMPXR
PI=3.141592654
PARW=MFREQ*PI*DCOS(MFREQ*PI*X(IHAVEP,ISWITCH) )
W=DSIN(MFREQ*PI*X(IHAVEP,ISWITCH))
XKM=(K*MACH)/BETA
IKM=II*XKM
XKW=K*W
IKW=II*XKW
IF (KOUNT.GT.12) GO TO 1001
WRITE(6,58) PARW,W,XKM,IKM,XKW,IKW
FORMAT (',',',',5X,'PARW =',E18.8,5X,'W =',E18.8,5X,'XKM =',E16.8/
1 ',',4X,'IKM =',2E10.5,2X,'KW =',E18.8,2X,'IKW =',2E10.5)

C
C
C
THE PROGRAM NOW GOES TO 30 IF POINT IS ON INITIAL MACH LINE.

1001 IF (IHAVEP.EQ.1) GO TO 30
C
C
TEST IF WE ARE AT A PANEL PT.

```



```

C      IF (IHAVEP.EQ.KOUNT) GO TO 40
C      GO TO 60
C 30   CALL MACHLN
C      GO TO 50
C 40   CALL PANPNT
C      GO TO 50
C 60   CALL GENFPT
C      WRITE OUT PUT
C      IF (KOUNT.GT.12) GO TO 1000
C 50   A=IHAVEP
C      B=ISWITCH
C      PX=(MACH/2.0)*(PHK(A,B)-PHI(A,B))
C      PR=(MACH/2.0)*IHAVEP,KOUNT,PX,PR
C 22   WRITE (6,61) ,IHAVEP, FOR RUN
C 61   FORMAT (10,' ',IHAVEP, PR =', I3,3X, 'KOUNT =', I3,
12X, 'PX =', 2F15.8, 5X, 'PR =', 2F15.8)
C 52   WRITE (6,52) X(A,B),R(A,B),PHI(A,B),PHK(A,B),QPHI(A,B)
C      FORMAT (', ',IX,2F14.5,3X,2F15.8,1X,2F15.8//)
C      IF (IHAVEP.EQ.KOUNT) GO TO 25
C 1000 GO TO 35
C      INCREMENT FOR NEXT LINES
C 25   IF (JSWITCH.EQ.1.) GO TO 103
C      ISWITCH=1
C      JSWITCH=2
C      IHAVEP=1
C      GO TO 108
C      SWITCH LINES HERE SO FIRST OLD (ILINE) BECOMES LAST NEW ONE
C      ZERO LINE COUNTER
C 103  ISWITCH=2
C      JSWITCH=1
C      IHAVEP=1
C      GO TO 108
C      AT 35 INCREMENT ALONG PRESENT LINE

```





```

C 35  IHAVEP=IHAVEP+1
    GO TO 104
108  KOUNT=KOUNT+1
    IF ((KOUNT-1).GT.MLINE) GO TO 101
    GO TO 100
101  WRITE (6,39)
39   FORMAT (////, ', ',10X,'CP')
    DO 37 KK=1,MLINE
    YYY(KK)=KK
36   WRITE (6,36) CP(KK)
37   FORMAT ( ', ',10X,2F18.8)
    CONTINUE
    IF (GRAPH.EQ.0.0) GO TO 1006
    NNN=MLINE
    MMM=0
    CALL PLOTP(YYY,REALCP,NNN,MMM)
    MMM=0
    CALL PLOTP(YYY,AMAGCP,NNN,MMM)
    IF (NUMRUN.EQ.2) GO TO 200
    STOP
    END
1006

```



```

SUBROUTINE COMPR (A-H, O-Z, $)
IMPLICIT REAL*8 (A-H, O-Z, $)
REAL*8 MACH, MANGL, K, KW
CC
CC COMPUTES THE X AND R COORDINATES
COMMON DPHI, DPHIK, PHI(400,2), PHK(400,2), QPHI(400,2), IPHI1, IPHI2,
4 IKM, IKW, PARW, W, II, REALCP(400), CP(400), AMAGCP(400),
1 MACH, K, MANGL, RADIUS, DELTAS, XLENGI, BETA, DSTSTR, HDSTRL, TRNGLH,
2 X(400,2), R(400,2), NFREQ, FINGRD, ISWTCH, JSWTCH, ILINE, MLINE, JLINE,
3 MFREQ, IHAVEP
  COMPLEX*16
  DPHI, DPHIK, PHI, IKM, CP, PX, IPHI1, IPHI2, IKW, PHK, II, QPHI
  INTEGER FINGRD
CC
CC TEST FOR POINT ON MACH LINE
IF (IHAVEP.EQ.1) GO TO 10
I=IHAVEP-1
J=IHAVEP-1
X(I, ISWTCH)=X(J)
R(I, ISWTCH)=R(J)
GO TO 6
I=IHAVEP
X(I, ISWTCH)=X(I)
R(I, ISWTCH)=R(I)
RETURN
END
10
6
CC

```



```

SUBROUTINE MACHLN
  IMPLICIT REAL*8 (A-H,O-Z,$)

SUBROUTINE MACHLN COMPUTES THE VALUE OF PHI AND ITS DERIVATIVES
ON THE INITIAL MACH LINE

COMMON DPHII,DPHIK,PHI(400,2),PHK(400,2),QPHI(400,2),IPHI1,IPHI2,
4 IKM,IKW,PARW,W,II,REALCP(400),CP(400),AMAGCP(400),
1 MACH,K,MANGL,RADIUS,DELTAS,XLENGT,BETA,DSTSTR,HDSTRL,TRNGLH,
2 X(400,2),R(400,2),NFREQ,FINGRD,ISWTCH,JSWTCH,ILINE,MLINE,JLINE,
3 MFREQ,IHAVEP,KOUNT
  REAL*8 MACH,MANGL,K,KW
  COMPLEX*16 AA2,
1 A,B,C,D,DPHII,DPHIK,PHI,IKM,CP,PX , IPHI1, IPHI2, IKW,PHK, II,QPHI
  INTEGER FINGRD
  I=IHAVEP
  N=NFREQ

  INFORCE THE BOUNDARY CONDITIONS

  PHK(I,ISWTCH)=(0,0)
  QPHI(I,ISWTCH)=(0,0)

  A=1-DELTAS/(4.*R(I,ISWTCH)*MACH)+0.5*IKM*DELTAS
  AA2=1.+DELTAS/(4.*R(I,JSWTCH)*MACH)-0.5*IKM*DELTAS
  PHI(I,ISWTCH)=PHI(I,JSWTCH)*(A/AA2)

  OUTPUT

  WRITE (6,1) QPHI(I,ISWTCH),PHI(I,ISWTCH),PHK(I,ISWTCH),A
  FORMAT ('0','LEAVING MACHLN QPHI =',2E15.5,5X,'PHI =',2E15.5,
1 /5X,'PHK =',2E15.5,5X,'A =',2E16.8)
  RETURN
  END

```



```

SUBROUTINE GENFPT
IMPLICIT REAL*8 (A-H,O-Z,$)

GENFPT COMPUTES PHI AND ITS DERIVATIVES AT A GENERAL FIELD PT.

COMMON DPHII,DPHIK,PHI(400,2),PHK(400,2),QPHI(400,2),IPHI1,IPHI2,
4IKM,IKW,PARW,W,II,REALCP(400),CP(400),AMAGCP(400),
MACH,K,MANGL,RADIUS,DELTAS,XLENGI,BETA, DSTSTR,HDSTR,TRNGLH,
1 X(400,2),R(400,2),NFREQ,FINGRD,ISWITCH,JSWITCH,ILINE,MLINE,JLINE,
3 MFREQ,IHAVEP,KOUNT
REAL*8 MACH,MANGL,K,KW
COMPLEX*16 AA1,AA2
1A,B,C,D,DPHII,DPHIK,PHI,IKM,CP,PX,IPHI1,IPHI2,IKW,PHK,II,QPHI
1 INTEGER FINGRD

I=IHAVEP
J=IHAVEP -1
N=NFREQ

A=1-DELTAS/(4.*R(I,ISWITCH)*MACH)+0.5*IKM*DELTAS
AA1=1+DELTAS/(4.*R(J,ISWITCH)*MACH)-0.5*IKM*DELTAS
AA2=1.+DELTAS/(4.*R(I,JSWITCH)*MACH)-0.5*IKM*DELTAS
B=DELTAS/(4.*R(I,ISWITCH)*MACH)+0.5*IKM*DELTAS-0.25*DELTAS**2*
1 (K**2-(N**2/R(I,ISWITCH)**2))
C=PHK(J,ISWITCH)*AA1+PHI(J,ISWITCH)*(-DELTAS/(4.*R(J,ISWITCH)*MACH)
1 -0.5*IKM*DELTAS+0.25*DELTAS**2*(K**2-(N**2/R(I,ISWITCH)**2)*MACH**
22)))+QPHI(J,ISWITCH)*DELTAS*0.5*(K**2-N**2/R(J,ISWITCH)**2)*MACH
3**2))+QPHI(J,ISWITCH)*DELTAS*0.5*(K**2-N**2/R(I,ISWITCH)**2)*
3**2))+QPHI(J,ISWITCH)*DELTAS*0.5*(K**2-N**2/R(I,ISWITCH)**2)*
4 MACH**2))
D=PHI(I,JSWITCH)*AA2+PHK(I,JSWITCH)*(-DELTAS/(4.*R(I,JSWITCH)*MACH)
1 -0.5*IKM*DELTAS+0.25*DELTAS**2*(K**2-(N**2/R(I,ISWITCH)**2)))+
22)))+QPHI(I,JSWITCH)*DELTAS*0.5*(K**2-N**2/R(I,JSWITCH)**2)*MACH
3**2))+QPHI(I,JSWITCH)*DELTAS*0.5*(K**2-N**2/R(I,ISWITCH)**2)*
4 MACH**2))

```





```

C      CRAMERS RULE
C      PHK(I,ISWITCH)=(C*A-B*D)/(A**2-B**2)
C      PHI(I,ISWITCH)=(D*A-C*B)/(A**2-B**2)
C      INTERGATE
C      IPHI1=QPHI(I,JSWITCH)+0.5*(PHK(I,JSWITCH)+PHK(I,ISWITCH))*DELTAS
C      IPHI2=QPHI(J,ISWITCH)+0.5*(PHI(J,ISWITCH)+PHI(I,ISWITCH))*DELTAS
C      AVERAGE THE TWO
C      QPHI(I,ISWITCH)=0.5*(IPHI1+IPHI2)
C      IF (KOUNT.GT.12) GO TO 15
C      OUTPUT
C      WRITE (6,10) A,B,C,D,AA1,AA2
10     FORMAT (10,3X,A=1,2F16.8,5X,B=1,2F16.8,/,
2     '1,5X,C=1,2F16.8,5X,D=1,2F16.8,/,1,5X,AA1=1,2E18.8,5X,
15     'AA2=1,2E18.8)
C      RETURN
C      END
C
C      SUBROUTINE PANPNT
C      IMPLICIT REAL*8 (A-H,O-Z,$)
C
C      PANPT COMPUTES THE VALUES OF PHI AND ITS DERIVATIVES AT A PANEL
C      POINT
C
C      COMMON DPHI1,DPHIK,PHI(400,2),PHK(400,2),QPHI(400,2),IPHI1,IPHI2,
4      IKM,IKW,PARW,W,II,REALCP(400),CP(400),AMAGCP(400),
1      MACH,K,MANGL,RADIUS,DELTAS,XLENGT,BETA,DSTSTR,HDSTRL,TRNGLH,
2      X(400,2),R(400,2),NFREQ,FINGRD,ISWITCH,JSWITCH,ILINE,MLINE,JLINE,
3      MFREQ,IHAVEP,KOUNT
C      REAL*8 MACH,MANGL,K,KW
C      COMPLEX*16
1      A,B,C,D,DPHI1,DPHIK,PHI,IKM,CP,PX,IPHI1,IPHI2,IKW,PHK,II,QPHI
C      INTEGER FINGRD
C
N=NFREQ
I=IHAVEP
J=IHAVEP-1
A=I-DELTAS/(4.*R(I,ISWITCH)*MACH)+0.5*IKM*DELTAS

```



```

C
1  AAI=1+DELTAS/(4.*R(J, ISWITCH)*MACH)-0.5*IKM*DELTAS
   B=DELTAS/(4.*R(I, ISWITCH)*MACH)+0.5*IKM*DELTAS-0.25*DELTAS**2*
   1 (K**2-(N**2/R(I, ISWITCH)**2))
C
1  C=PHK(J, ISWITCH)*AAI+PHI(J, ISWITCH)*(-DELTAS/(4.*R(J, ISWITCH)*MACH)
   2 -0.5*IKM*DELTAS+0.25*DELTAS**2*(K**2-(N**2/R(I, ISWITCH)**2)*MACH**
   4 22))+ QPHI(J, ISWITCH)*DELTAS*0.5*(K**2-N**2/(R(J, ISWITCH)**2)*MACH
   4  MACH**2))
C
C   CRAMERS RULE
C   PHK(I, ISWITCH)= (C+B*(2.0/MACH)*(PARW+IKW))/(A+B)
C   PHI(I, ISWITCH)= (-A*(2.0/MACH)*(PARW+IKW)+C)/(A+B)
C
1  QPHI(I, ISWITCH)=QPHI(J, ISWITCH)+0.5*(PHI(J, ISWITCH)+PHI(I
   1  ISWITCH))*DELTAS
C
C   COMPUTES THE CP ON THE PANEL
C
C   PX=(MACH/(2.0*BETA))*(PHK(I, ISWITCH)+PHI(I, ISWITCH))
C   CP(KOUNT)=-2.0*(I*K*QPHI(I, ISWITCH)+PX)
C   AMAGCP(KOUNT)=AIMAG(CP(KOUNT))
C   REALCP(KOUNT)=REAL(CP(KOUNT))
C
C   OUTPUT
C
1  WRITE (6,1) QPHI(I, ISWITCH), PHI(I, ISWITCH), PHK(I, ISWITCH), C
   U  FORMAT (10, 'LEAVING PANPNT QPHI =', 2E15.5, 5X, 'PHI =', 2E15.5,
   U  /5X, 'PHK =', 2E15.5, 5X, 'C =', 2D16.8)
   U  RETURN
   U  END

```



APPENDIX C: VIBRATING PANEL SAMPLE COMPUTER OUTPUT

LINEARIZED METHOD OF CHARACTERISTICS  
FOR SUPERSONIC FLOW PAST A VIBRATING PANEL

DATE OF RUN-22 FEB 1972

FREESTREAM MACH NUMBER = 1.414213

REDUCED FREQ= 2.00000

GRID FINENESS IS = 60

AXIAL MODE NO. M = 4

INITIAL VALUE OF  $\phi$  PHI = 0.0    0.0    PHI = -0.1777D 020.0    PHK = 0.0    0.0  
X = 0.0    R = 0.100D 01PARW = 0.126D 02

KOUNT = 2  
CONSTANTS AT NEW POINT  
PARW = 0.12498D 02    W = 0.10453D 00  
IKM & IKW = 0.28284D 01  
MACHLN A = 0.10000000D 01    0.166666680D-01

IHAVEP FOR RUN = 1    KOUNT = 2  
PX = -12.55940122    0.41876336    PR = 12.55939123  
0.00833    1.00833    -17.7616685    0.5922206  
0.0    0.0

CONSTANTS AT NEW POINT  
PARW = 0.12292D 02    W = 0.20791D 00  
IKM & IKW = 0.28284D 01  
PANPT C = 0.74034507D-02    0.29611030D 00    .41582D 00



|                           |                |             |              |             |  |  |  |  |             |
|---------------------------|----------------|-------------|--------------|-------------|--|--|--|--|-------------|
| IHAVEP FOR RUN = 2        | KOUNT = 2      |             |              |             |  |  |  |  |             |
| PX = -12.27098406         | 0.41197224     | -17.3684866 | PR =         | 12.29176527 |  |  |  |  | 0.41582338  |
| 0.01667                   | 1.00000        | -0.20701    |              | -0.0027234  |  |  |  |  |             |
| 0.01470                   | 0.58534        |             |              | 0.00347     |  |  |  |  |             |
|                           |                |             |              |             |  |  |  |  |             |
| KCUNT = 3                 |                |             |              |             |  |  |  |  |             |
| CONSTANTS AT NEW POINT    |                |             |              |             |  |  |  |  |             |
| PARW = 0.12292D 02        | W = .20791D 00 |             |              |             |  |  |  |  |             |
| IKM & IKW = 0             | .28284D 01     | 0           |              |             |  |  |  |  |             |
| MACHLN A = 0.10C00000D 01 | 0.16666680D-01 |             |              |             |  |  |  |  |             |
| IHAVEP FOR RUN = 1        | KOUNT = 3      |             |              |             |  |  |  |  |             |
| PX = -12.53847078         | 0.83706156     | PR =        | 12.53846081  |             |  |  |  |  | -0.83706090 |
| 0.01667                   | 1.01667        | -17.7320684 | 1.1837833    |             |  |  |  |  |             |
| 0.0                       | 0.0            |             | 0.0          |             |  |  |  |  |             |
|                           |                |             |              |             |  |  |  |  |             |
| CCNSTANTS AT NEW POINT    |                |             |              |             |  |  |  |  |             |
| PARW = 0.11951D 02        | W = .30902D 00 |             |              |             |  |  |  |  |             |
| IKM & IKW = 0             | .28284D 01     | 0           |              |             |  |  |  |  |             |
| GENFPT A = 1.00000000     | 0.01666668B =  |             |              |             |  |  |  |  |             |
| C = 0.01726695            | 0.29569912     | D =         | -17.36853268 |             |  |  |  |  | 0.28675163  |
|                           |                |             | .61803D 00   |             |  |  |  |  |             |
| IHAVEP FOR RUN = 2        | KOUNT = 3      |             |              |             |  |  |  |  |             |
| PX = -12.24356674         | 0.82008816     | PR =        | 12.29190471  |             |  |  |  |  | 0.00632595  |
| 0.02500                   | 1.00833        | -17.3491983 | 0.5754165    |             |  |  |  |  |             |
| 0.03419                   | 0.58436        |             | 0.01037      |             |  |  |  |  |             |
|                           |                |             |              |             |  |  |  |  |             |
| CONSTANTS AT NEW POINT    |                |             |              |             |  |  |  |  |             |
| PARW = 0.11480D 02        | W = .40674D 00 |             |              |             |  |  |  |  |             |
| IKM & IKW = 0             | .28284D 01     | 0           |              |             |  |  |  |  |             |
| PANPT C = 0.41362261D-01  | 0.87351513D 00 |             |              |             |  |  |  |  |             |
| IHAVEP FOR RUN = 3        | KOUNT = 3      |             |              |             |  |  |  |  |             |
| PX = -11.39791587         | 0.80179271     | PR =        | 11.47995080  |             |  |  |  |  | 0.81347329  |
| 0.03333                   | 1.00000        | -16.1770947 | -0.0082599   |             |  |  |  |  |             |
| 0.05801                   | 1.14217        |             | 0.01371      |             |  |  |  |  |             |
|                           |                |             |              |             |  |  |  |  |             |
| KCUNT = 4                 |                |             |              |             |  |  |  |  |             |
| CONSTANTS AT NEW POINT    |                |             |              |             |  |  |  |  |             |
| PARW = 0.11951D 02        | W = .30902D 00 |             |              |             |  |  |  |  |             |
| IKM & IKW = 0             | .28284D 01     | 0           |              |             |  |  |  |  |             |
| MACHLN A = 0.10000000D 01 | 0.16666680D-01 |             |              |             |  |  |  |  |             |





IHAVEP FOR RUN = 1 KOUNT = 4  
 PX = -12.50361256 1.25442995 PR = 12.50360262 -1.25442895  
 0.02500 1.02500 -17.6827714 0.0 1.7740311  
 0.0 0.0

CONSTANTS AT NEW POINT  
 PARW = 0.11480D 02 W = .40674D 00  
 IKM & IKW = .0 28284D 01 .0  
 GENFPT A = 1.00000000 0.01666668B = .81347D 00  
 C = 0.02711127 0.29495949 D = -17.33960864 0.01666668  
 0.86457012

IHAVEP FOR RUN = 2 KOUNT = 4  
 PX = -12.20258943 1.22683527 PR = 12.27841520 -0.40271945  
 0.03333 1.01667 -17.3106844 1.1522690  
 0.05362 0.58274 -0.20620 0.01724

CONSTANTS AT NEW POINT  
 PARW = 0.10883D 02 W = .50000D 00  
 IKM & IKW = .0 28284D 01 .0  
 GENFPT A = 1.00000000 0.01666668B = .10000D 01  
 C = 0.07041592 0.87132823 D = -16.17724585 0.01666668  
 0.26119654

IHAVEP FOR RUN = 3 KOUNT = 4  
 PX = -11.35151762 1.17936428 PR = 11.48723180 0.43136818  
 0.04167 1.00833 -16.1494346 0.5289127  
 0.09597 1.13896 -0.40337 0.02715

CONSTANTS AT NEW POINT  
 PARW = 0.10166D 02 W = .58779D 00  
 IKM & IKW = .0 28284D 01 .0  
 PANPT C = 0.10251085D 00 0.14078709D 01  
 .11756D 01

IHAVEP FOR RUN = 4 KOUNT = 4  
 PX = -9.98596471 1.14832144 PR = 10.16640739 1.17557050  
 0.05000 1.00000 -14.2498790 -0.0192687  
 0.12760 1.64324 -0.58250 0.03015

KCUNT = 5  
 CONSTANTS AT NEW POINT  
 PARW = 0.11480D 02 W = .40674D 00  
 IKM & IKW = .0 28284D 01 .0  
 MACHLN A = 0.10000000D 01 0.16666680D-01  
 .81347D 00



IHAVEP FOR RUN = 1 KOUNT = 5  
 PX = -12.45486528 1.67040491 -17.6138324 PR = 12.45485537 -1.67040358  
 0.03333 1.03333 0.0 0.0 2.3623083  
 0.0 0.0 0.0

CONSTANTS AT NEW POINT  
 PARW = 0.10883D 02 W = .50000D 00  
 IKM & IKW = .0 .28284D 01 0  
 GENFPT A = 1.00000000 0.01666668B = .10000D 01  
 C = 0.03692547 0.29389221 D = -17.29148057 0.013889 0.01666668  
 1.44078067

IHAVEP FOR RUN = 2 KOUNT = 5  
 PX = -12.14811285 1.63176349 -17.2530094 PR = 12.25132697 -0.81085967  
 0.04167 1.02500 0.58047 1.7271952  
 0.07299 0.02410

CONSTANTS AT NEW POINT  
 PARW = 0.10166D 02 W = .58779D 00  
 IKM & IKW = .0 .28284D 01 0  
 GENFPT A = 1.00000000 0.01666668B = .11756D 01  
 C = 0.09936982 0.86817572 D = -16.14063830 0.00013889 0.01666668  
 0.79790866

IHAVEP FOR RUN = 3 KOUNT = 5  
 PX = -11.29263803 1.55473753 -16.1039742 PR = 11.48182061 0.04967939  
 0.05000 1.01667 1.13449 1.0642364  
 0.13378 0.040201

CONSTANTS AT NEW POINT  
 PARW = 0.93386D 01 W = .66913D 00  
 IKM & IKW = .0 .28284D 01 0  
 GENFPT A = 1.00000000 0.01666668B = .13383D 01  
 C = 0.14923647 1.40272298 D = -14.25025424 0.00013889 0.01666668  
 0.21775254

IHAVEP FOR RUN = 4 KOUNT = 5  
 PX = -9.92307994 1.47682439 -14.2154199 PR = 10.18055951 0.83778395  
 0.05833 1.00833 1.63668 0.4518692  
 0.18207 0.58067

CCNSTANTS AT NEW POINT  
 PARW = 0.84085D 01 W = .74314D 00  
 IKM & IKW = .0 .28284D 01 0  
 PANPT C = 0.18753280D 00 0.18729597D 01 .14863D 01



|          |             |   |   |            |   |             |      |            |            |
|----------|-------------|---|---|------------|---|-------------|------|------------|------------|
| I HAVE P | FOR RUN     | = | 5 | KOUNT =    | 5 |             |      |            |            |
| PX =     | -8.09788429 |   |   | 1.43239740 |   | -11.6718069 | PR = | 8.40854319 | 1.48628965 |
|          | 0.06667     |   |   | 1.00000    |   | -0.73321    |      | -0.0381084 |            |
|          | 0.21967     |   |   | 2.06382    |   |             |      | 0.05192    |            |



COEFFICIENT OF PRESSURE

|      |              |             |
|------|--------------|-------------|
| 1.0  | 0.0          | 0.0         |
| 2.0  | 24.55586270  | 0.00408154  |
| 3.0  | 22.85066452  | 0.01351091  |
| 4.0  | 20.09254127  | 0.03334298  |
| 5.0  | 16.40344123  | 0.06806011  |
| 6.0  | 11.94654108  | 0.12131901  |
| 7.0  | 6.91909287   | 0.19573567  |
| 8.0  | 1.54377602   | 0.29271826  |
| 9.0  | -3.94106736  | 0.41235615  |
| 10.0 | -9.29188676  | 0.55337020  |
| 11.0 | -14.27060977 | 0.71312712  |
| 12.0 | -18.65509318 | 0.88771781  |
| 13.0 | -22.24888160 | 1.07209644  |
| 14.0 | -24.88984639 | 1.26027485  |
| 15.0 | -26.45732668 | 1.44556368  |
| 16.0 | -26.87745992 | 1.62085036  |
| 17.0 | -26.12646822 | 1.77890147  |
| 18.0 | -24.23175624 | 1.91267680  |
| 19.0 | -21.27077195 | 2.01564102  |
| 20.0 | -17.36767944 | 2.08205951  |
| 21.0 | -12.68798847 | 2.10726521  |
| 22.0 | -7.43137495  | 2.08788457  |
| 23.0 | -1.82300542  | 2.02201259  |
| 24.0 | 3.89625584   | 1.90932880  |
| 25.0 | 9.48032952   | 1.75114890  |
| 26.0 | 14.68863637  | 1.55040919  |
| 27.0 | 19.29657652  | 1.31158411  |
| 28.0 | 23.10531564  | 1.04053992  |
| 29.0 | 25.95045047  | 0.74433023  |
| 30.0 | 27.70917520  | 0.43094193  |
| 31.0 | 28.30563578  | 0.10900179  |
| 32.0 | 27.71423823  | -0.21254394 |
| 33.0 | 25.96076634  | -0.52476371 |
| 34.0 | 23.12126002  | -0.81907450 |
| 35.0 | 19.31870316  | -1.08756155 |
| 36.0 | 14.71766553  | -1.32327050 |
| 37.0 | 9.51713284   | -1.52045979 |
| 38.0 | 3.94183787   | -1.67480302 |
| 39.0 | -1.76752874  | -1.78353270 |





|      |              |             |
|------|--------------|-------------|
| 40.0 | -7.36480060  | -1.84551983 |
| 41.0 | -12.60905291 | -1.86128623 |
| 42.0 | -17.27508720 | -1.83294939 |
| 43.0 | -21.16322567 | -1.76410272 |
| 44.0 | -24.10798772 | -1.65963661 |
| 45.0 | -25.98527008 | -1.52550839 |
| 46.0 | -26.71771716 | -1.36847141 |
| 47.0 | -26.27804790 | -1.19577514 |
| 48.0 | -24.69019390 | -1.01484935 |
| 49.0 | -22.02820014 | -0.83298627 |
| 50.0 | -18.41293660 | -0.65703434 |
| 51.0 | -14.00676536 | -0.49311690 |
| 52.0 | -9.00639664  | -0.34638770 |
| 53.0 | -3.63424668  | -0.22083373 |
| 54.0 | 1.87132446   | -0.11913365 |
| 55.0 | 7.26646797   | -0.04257745 |
| 56.0 | 12.31253691  | 0.00894953  |
| 57.0 | 16.78654483  | 0.03691793  |
| 58.0 | 20.49093494  | 0.04404391  |
| 59.0 | 23.26223271  | 0.03412212  |
| 60.0 | 24.97820347  | 0.01181008  |



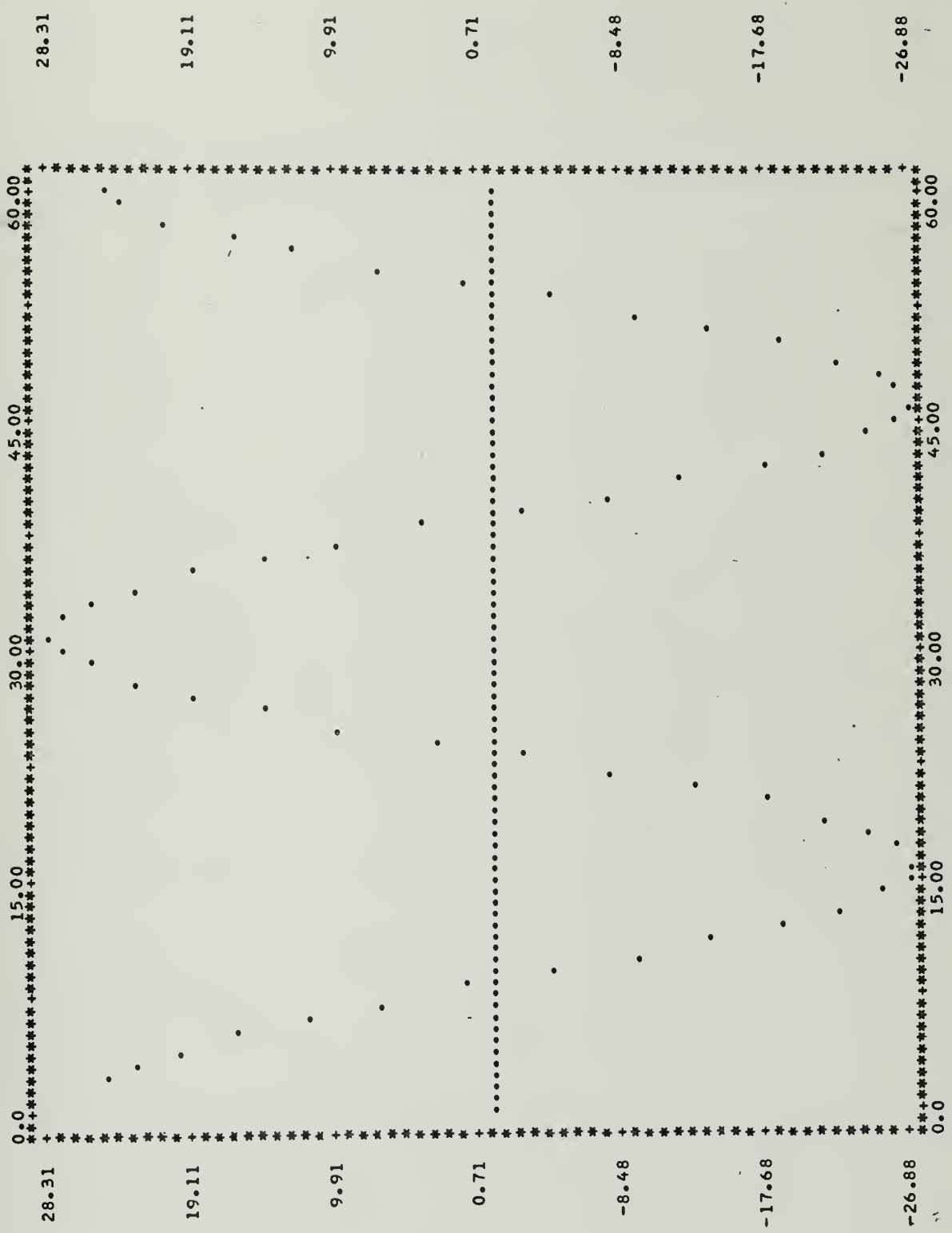



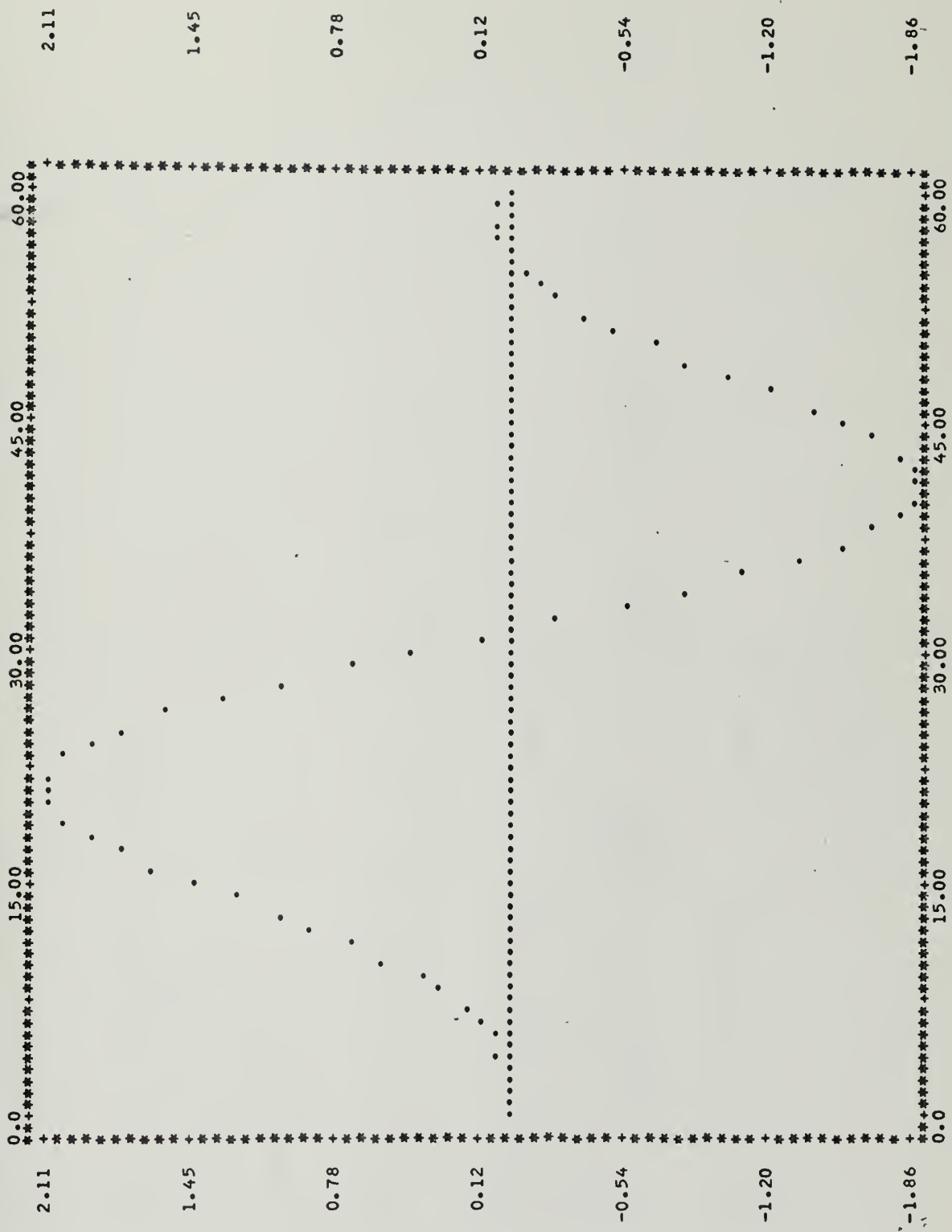



APPENDIX D: VIBRATING SHELL SAMPLE COMPUTER OUTPUT

LINEARIZED METHOD OF CHARACTERISTICS  
 FOR SUPERSONIC FLOW PAST A VIBRATING CYLINDRICAL SHELL  
 DATE OF RUN-26 FEB 1972

FREESTREAM MACH NUMBER = 3.500000  
 REDUCED FREQ= 0.0  
 RAD MODE NO. N = 0  
 GRID FINENESS IS = \*\*  
 CYLINDER RADIUS IS = 0.20  
 AXIAL MODE NO. M = 3

INITIAL VALUE OF GPHI = 0.0 0.0 0.0 PHI = -.5386D 010.0  
 X = 0.0 R = .200D 00 PARW = 0.942D 01 PHK = 0.0 0.0

KCUNT = 2  
 CONSTANTS AT NEW POINT  
 PARW = 0.94175D 01 W = .39260D-01  
 IKM & IKW = .0 .0  
 MACHLN A = 0.99845676D 00 0.0

IHAVEP FOR RUN = 1 KCUNT = 2  
 PX = -2.81863905 0.0 PR = 9.45400278  
 0.00417 0.20124 -5.4022873 0.0  
 0.0 0.0 0.0

CONSTANTS AT NEW POINT  
 PARW = 0.93957D 01 W = .78459D-01  
 IKM & IKW = .0 .0  
 PANPNT C = 0.83370229D-02 0.0





I HAVEP FOR RUN = 2 KOUNT = 2  
 PX = -2.78386441 0.0  
 0.00833 0.20000 PR = 9.39572452 0.0  
 0.01667 0.0 -0.02338 0.0

KOUNT = 3  
 CONSTANTS AT NEW POINT  
 PARW = 0.93957D 01 W = .78459D-01  
 IKM & IKW = .0  
 MACHLN A = 0.99846623D 00 C.0

I HAVEP FOR RUN = 1 KOUNT = 3  
 PX = -2.82732536 0.0  
 0.00833 0.20248 PR = 9.48313754 0.0  
 0.0 0.0 -5.4189357 0.0

CONSTANTS AT NEW POINT  
 PARW = 0.93554D 01 W = .11754D 00  
 IKM & IKW = .0  
 GENFPT A = 0.99845676 0.0 D = -5.36064842 0.0  
 C = 0.00831141 0.0 B = 0.00154324 0.0

I HAVEP FOR RUN = 2 KOUNT = 3  
 PX = -2.79257752 0.0  
 0.01250 0.20124 PR = 9.42476904 0.0  
 0.01667 0.0 -0.02338 0.0

CONSTANTS AT NEW POINT  
 PARW = 0.93087D 01 W = .15643D 00  
 IKM & IKW = .0  
 PANPNT C = 0.24933896D-01 0.0

I HAVEP FOR RUN = 3 KOUNT = 3  
 PX = -2.74069336 0.0  
 0.01667 0.20000 PR = 9.30874331 0.0  
 0.03319 0.0 -0.04654 0.0

KOUNT = 4  
 CONSTANTS AT NEW POINT  
 PARW = 0.93594D 01 W = .11754D 00  
 IKM & IKW = .0  
 MACHLN A = 0.99847558D 00 0.0

I HAVEP FOR RUN = 1 KOUNT = 4  
 PX = -2.83598506 0.0  
 PR = 9.51218306 0.0



0.01250 0.20373 -5.4355332 0.0 0.0  
0.0 0.0 0.0 0.0

CONSTANTS AT NEW POINT  
PARW = 0.93087D 01 W = .15643D 00  
IKM & IKW = .0 0.0  
GENFPT A = 0.99846623 0.0 D = B = .0 0.00153377 0.0 0.0  
C = 0.00828603 0.0 -5.37727090 0.0

IHAVEP FOR RUN = 2 KOUNT = 4 PR = 9.45372434 0.0  
PX = -2.80126353 0.0 -5.3855565 0.0  
0.01667 0.20248 -0.02342 0.0  
0.01657

CONSTANTS AT NEW POINT  
PARW = 0.92437D 01 W = .19509D 00  
IKM & IKW = .0 0.0  
GENFPT A = 0.99845676 0.0 D = B = .0 0.00154324 0.0  
C = 0.02485729 0.0 -5.29434799 0.0

IHAVEP FOR RUN = 3 KOUNT = 4 PR = 9.33742903 0.0  
PX = -2.74935253 0.0 -5.3025822 0.0  
0.02083 0.20124 -0.04653 0.0  
0.03309

CONSTANTS AT NEW POINT  
PARW = 0.91644D 01 W = .23345D 00  
IKM & IKW = .0 0.0  
PANPNT C = 0.41325736D-01 0.0 .0

IHAVEP FOR RUN = 4 KOUNT = 4 PR = 9.16437060 0.0  
PX = -2.68C67855 0.0 -5.1873257 0.0  
0.02500 0.20000 -0.06933 0.0  
0.04946

KOUNT = 5  
CONSTANTS AT NEW POINT  
PARW = 0.93087D 01 W = .15643D 00  
IKM & IKW = .0 0.0  
MACHLN A = 0.99848482D 00 0.0 .0

IHAVEP FOR RUN = 1 KOUNT = 5 PR = 9.54114016 0.0  
PX = -2.84461840



0.01667 0.20497 -5.4520801 0.0 0.0  
0.0 0.0

CONSTANTS AT NEW POINT  
PARW = 0.92437D 01 W = .19509D 00  
IKM & IKW = .0 0.0  
GENFPT A = 0.99847558 0.0 D = B = .0 0.00152442 0.0 0.0  
C = 0.00826088 0.0 D = -5.39384216 0.0 0.0

IHAVEP FOR RUN = 2 KOUNT = 5  
PX = -2.80992270 0.0 PR = 9.48259122 0.0  
0.02083 0.20373 -5.4021024 0.0  
0.01652 0.0 -0.02347 0.0

CONSTANTS AT NEW POINT  
PARW = 0.91644D 01 W = .23345D 00  
IKM & IKW = .0 0.0  
GENFPT A = 0.99846623 0.0 D = B = .0 0.00153377 0.0 0.0  
C = 0.02478139 0.0 D = -5.31081644 0.0 0.0

IHAVEP FOR RUN = 3 KOUNT = 5  
PX = -2.75798453 0.0 PR = 9.36602689 0.0  
0.02500 0.20248 -5.3190252 0.0  
0.03299 0.0 -0.04658 0.0

CONSTANTS AT NEW POINT  
PARW = 0.90709D 01 W = .27144D 00  
IKM & IKW = .0 0.0  
GENFPT A = 0.99845676 0.0 D = B = .0 0.00154324 0.0 0.0  
C = 0.04119893 0.0 D = -5.19545746 0.0 0.0

IHAVEP FOR RUN = 4 KOUNT = 5  
PX = -2.68923024 0.0 PR = 9.19252120 0.0  
0.02917 0.20124 -5.2035639 0.0  
0.04931 0.0 -0.06929 0.0

CONSTANTS AT NEW POINT  
PARW = 0.89635D 01 W = .30902D 00  
IKM & IKW = .0 0.0  
PANPNT C = 0.57411798D-01 0.0 .0









|      |             |     |
|------|-------------|-----|
| 1.0  | 5.61985179  | 0.0 |
| 2.0  | 5.56772383  | 0.0 |
| 3.0  | 5.48138671  | 0.0 |
| 4.0  | 5.36135710  | 0.0 |
| 5.0  | 5.20837936  | 0.0 |
| 6.0  | 5.02339600  | 0.0 |
| 7.0  | 4.80754686  | 0.0 |
| 8.0  | 4.56216209  | 0.0 |
| 9.0  | 4.28875394  | 0.0 |
| 10.0 | 3.98900744  | 0.0 |
| 11.0 | 3.66477001  | 0.0 |
| 12.0 | 3.31804007  | 0.0 |
| 13.0 | 2.95095473  | 0.0 |
| 14.0 | 2.56577658  | 0.0 |
| 15.0 | 2.16487980  | 0.0 |
| 16.0 | 1.75073545  | 0.0 |
| 17.0 | 1.32589630  | 0.0 |
| 18.0 | 0.89298105  | 0.0 |
| 19.0 | 0.45465819  | 0.0 |
| 20.0 | 0.01362957  | 0.0 |
| 21.0 | -0.42738628 | 0.0 |
| 22.0 | -0.86567090 | 0.0 |
| 23.0 | -1.29852267 | 0.0 |
| 24.0 | -1.72327345 | 0.0 |
| 25.0 | -2.13730505 | 0.0 |
| 26.0 | -2.53806536 | 0.0 |
| 27.0 | -2.92308408 | 0.0 |
| 28.0 | -3.28998796 | 0.0 |
| 29.0 | -3.63651544 | 0.0 |
| 30.0 | -3.96053057 | 0.0 |
| 31.0 | -4.26003619 | 0.0 |
| 32.0 | -4.53318625 | 0.0 |
| 33.0 | -4.77829719 | 0.0 |
| 34.0 | -4.99385832 | 0.0 |
| 35.0 | -5.17854110 | 0.0 |
| 36.0 | -5.33120741 | 0.0 |
| 37.0 | -5.45091646 | 0.0 |
| 38.0 | -5.53693070 | 0.0 |
| 39.0 | -5.58872029 | 0.0 |



|      |             |     |
|------|-------------|-----|
| 40.0 | -5.60596640 | 0.0 |
| 41.0 | -5.58856315 | 0.0 |
| 42.0 | -5.53661830 | 0.0 |
| 43.0 | -5.45045257 | 0.0 |
| 44.0 | -5.33059765 | 0.0 |
| 45.0 | -5.17779292 | 0.0 |
| 46.0 | -4.99298092 | 0.0 |
| 47.0 | -4.77730152 | 0.0 |
| 48.0 | -4.53208488 | 0.0 |
| 49.0 | -4.25884328 | 0.0 |
| 50.0 | -3.95926178 | 0.0 |
| 51.0 | -3.63518781 | 0.0 |
| 52.0 | -3.28861982 | 0.0 |
| 53.0 | -2.92169493 | 0.0 |
| 54.0 | -2.53667577 | 0.0 |
| 55.0 | -2.13593651 | 0.0 |
| 56.0 | -1.72194827 | 0.0 |
| 57.0 | -1.29726381 | 0.0 |
| 58.0 | -0.86450186 | 0.0 |
| 59.0 | -0.42633093 | 0.0 |
| 60.0 | 0.01454712  | 0.0 |
| 61.0 | 0.45541373  | 0.0 |
| 62.0 | 0.89355043  | 0.0 |
| 63.0 | 1.32625557  | 0.0 |
| 64.0 | 1.75086101  | 0.0 |
| 65.0 | 2.16474854  | 0.0 |
| 66.0 | 2.56536602  | 0.0 |
| 67.0 | 2.95024315  | 0.0 |
| 68.0 | 3.31700666  | 0.0 |
| 69.0 | 3.66339496  | 0.0 |
| 70.0 | 3.98727210  | 0.0 |
| 71.0 | 4.28664090  | 0.0 |
| 72.0 | 4.55965530  | 0.0 |
| 73.0 | 4.80463172  | 0.0 |
| 74.0 | 5.02005944  | 0.0 |
| 75.0 | 5.20460994  | 0.0 |
| 76.0 | 5.35714505  | 0.0 |
| 77.0 | 5.47672401  | 0.0 |
| 78.0 | 5.56260922  | 0.0 |
| 79.0 | 5.61427083  | 0.0 |
| 80.0 | 5.63139000  | 0.0 |
| 81.0 | 5.61386085  | 0.0 |
| 82.0 | 5.56179113  | 0.0 |
| 83.0 | 5.47550153  | 0.0 |
| 84.0 | 5.35552372  | 0.0 |
| 85.0 | 5.20259710  | 0.0 |



|       |             |     |
|-------|-------------|-----|
| 86.0  | 5.01766417  | 0.0 |
| 87.0  | 4.80186480  | 0.0 |
| 88.0  | 4.55652915  | 0.0 |
| 89.0  | 4.28316947  | 0.0 |
| 90.0  | 3.98347081  | 0.0 |
| 91.0  | 3.65928060  | 0.0 |
| 92.0  | 3.31259727  | 0.0 |
| 93.0  | 2.94555794  | 0.0 |
| 94.0  | 2.56042522  | 0.0 |
| 95.0  | 2.15957328  | 0.0 |
| 96.0  | 1.74547322  | 0.0 |
| 97.0  | 1.32067779  | 0.0 |
| 98.0  | 0.88780571  | 0.0 |
| 99.0  | 0.44952549  | 0.0 |
| 100.0 | 0.00853898  | 0.0 |
| 101.0 | -0.43243528 | 0.0 |
| 102.0 | -0.87067882 | 0.0 |
| 103.0 | -1.30349001 | 0.0 |
| 104.0 | -1.72820071 | 0.0 |
| 105.0 | -2.14219271 | 0.0 |
| 106.0 | -2.54291390 | 0.0 |
| 107.0 | -2.92789396 | 0.0 |
| 108.0 | -3.29475966 | 0.0 |
| 109.0 | -3.64124940 | 0.0 |
| 110.0 | -3.96522724 | 0.0 |
| 111.0 | -4.26469601 | 0.0 |
| 112.0 | -4.53780966 | 0.0 |
| 113.0 | -4.78288461 | 0.0 |
| 114.0 | -4.99841016 | 0.0 |
| 115.0 | -5.18305778 | 0.0 |
| 116.0 | -5.33568933 | 0.0 |
| 117.0 | -5.45536403 | 0.0 |
| 118.0 | -5.54134431 | 0.0 |
| 119.0 | -5.59310032 | 0.0 |
| 120.0 | -5.61031322 | 0.0 |



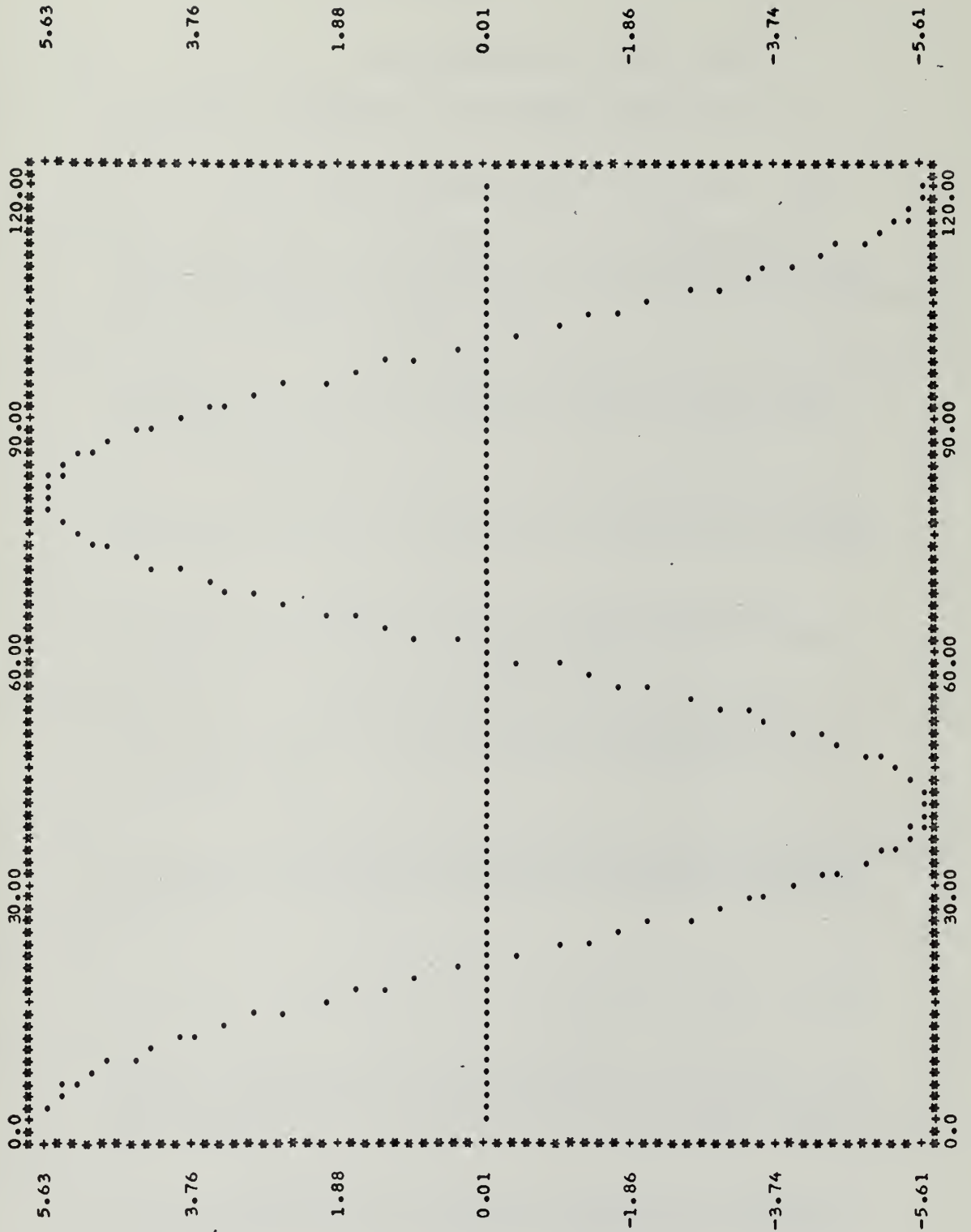





## REFERENCES

1. John, James E. A., Gas Dynamics, Boston 1969.
2. I. H. Shames, Mechanics of Fluids, Appendix A-2, McGraw-Hill, 1962.
3. Wang, Chi-Teh, Applied Elasticity, New York, 1953.
4. Nelson, H. C. and Cunningham, H. J., Theoretical Investigation of Flutter of a Two-Dimensional Flat Panel with One Surface Exposed to Supersonic Potential Flow, NACA Report 1280, 1956.
5. Anderson, W. J., Oscillatory Pressure in an Idealized Boundary Layer with an Application to the Panel Flutter of Cylindrical Shells, AIAA Journal, Vol. 4, No. 5, May 1966.
6. Dowell, E. H. and Widnall, S. E., Generalized Aerodynamic Forces on an Oscillating Cylindrical Shell, MIT, 1966.
7. Dowell, E. H., Panel Flutter: A Review of the Aeroelastic Stability of Plates and Shells, AIAA Journal, Vol. 8, No. 3, March 1970.
8. Garrick, I. E., Nonsteady Wing Characteristics, Section F, Vol. VII, High Speed Aerodynamics and Jet Propulsion, Princeton University Press, Princeton 1957.
9. Haack, W., Charakteristikenverfahren zur näherungsweise Berechnung der unsymmetrischen Überschallströmung um ringförmige Körper, ZAMP, Vo. II, pp. 357-375, 1951.
10. Sauer, R., Unpublished Report, see "Gasdynamics" by Oswatitsch, Section VIII for detailed description.
11. Erdmann, S. and K. Oswatitsch, Schnell arbeitende lineare Charakteristiken-verfahren für axiale und schräge Überschallanströmung um Rotations-körper mit Ringflächen, Z. F. Flugwiss., pp. 201-215, 1954.
12. Teipel, I., Charakteristikenverfahren zur Berechnung der verallgemeinerten ebenen Flatter-luftkräfte, Z. F. Flugwiss., 10, 374-379, 1962.



13. Platzter, M. F. and A. D. Sherer, Dynamic Stability Analysis of Bodies of Revolution in Supersonic Flow, J. Spacecraft and Rockets, Vol. 5, No. 7, pp. 833-837, 1968.



INITIAL DISTRIBUTION LIST

|  | No. Copies |
|--|------------|
| 1. Defense Documentation Center<br>Cameron Station<br>Alexandria, Virginia 22314   | 2          |
| 2. Library, Code 0212<br>Naval Postgraduate School<br>Monterey, California 93940   | 2          |
| 3. Professor M. F. Platzler, Code 57P1<br>Department of Aeronautics<br>Naval Postgraduate School<br>Monterey, California 93940 | 15         |
| 4. Department of Aeronautics, Code 57<br>Naval Postgraduate School<br>Monterey, California 93940                               | 1          |
| 5. LCDR Kenneth A. Webster<br>NARTU<br>NAS Point Mugu, California 93010  | 2          |



DOCUMENT CONTROL DATA - R & D

(Security classification of title, body of abstract and indexing annotation must be entered when the overall report is classified)

|   |  |
|---|--|
| 1. ORIGINATING ACTIVITY (Corporate author)<br>Naval Postgraduate School<br>Monterey, California 93940 | 2a. REPORT SECURITY CLASSIFICATION<br>Unclassified |
|   | 2b. GROUP  |

3. REPORT TITLE  
A Study of Supersonic Flow Past Vibrating Panels and Shells

4. DESCRIPTIVE NOTES (Type of report and inclusive dates)  
Master's Thesis, March 1972

5. AUTHOR(S) (First name, middle initial, last name)  
Kenneth A. Webster

|                              |                              |                       |
|------------------------------|------------------------------|-----------------------|
| 6. REPORT DATE<br>March 1972 | 7a. TOTAL NO. OF PAGES<br>99 | 7b. NO. OF REFS<br>13 |
|------------------------------|------------------------------|-----------------------|

|   |   |
|---|---|
| 8a. CONTRACT OR GRANT NO.<br><br>b. PROJECT NO.<br><br>c.<br><br>d. | 9a. ORIGINATOR'S REPORT NUMBER(S)   |
|   | 9b. OTHER REPORT NO(S) (Any other numbers that may be assigned this report) |
|   |   |
|   |   |

10. DISTRIBUTION STATEMENT  
Approved for public release; distribution unlimited.

|                         |   |
|-------------------------|---|
| 11. SUPPLEMENTARY NOTES | 12. SPONSORING MILITARY ACTIVITY<br>Naval Postgraduate School<br>Monterey, California 93940 |
|-------------------------|---|

13. ABSTRACT

Supersonic flow past harmonically vibrating two-dimensional panels and cylindrical shells is analyzed using a linearized method-of-characteristics procedure. A detailed description of this method to solve the linearized unsteady potential equation is given and numerical results are presented to indicate the nature of the aerodynamic pressure distributions. Also, comparisons of the present results are made with earlier work by Nelson and Cunningham and by Anderson which is based upon quite different approaches.





| 14. KEY WORDS  | LINK A |    | LINK B |    | LINK C |    |
|--|--------|----|--------|----|--------|----|
|  | ROLE   | WT | ROLE   | WT | ROLE   | WT |
| Method of Characteristics<br>Supersonic Flow<br>Vibrating Shells |        |    |        |    |        |    |



Thesis  
W3325  
c.1

Webster

A study of supersonic  
flow past vibrating  
panels and shells.

133942

Thesis  
W3325  
c.1

Webster

A study of supersonic  
flow past vibrating  
panels and shells.

133942

thesW3325

A study of supersonic flow past vibratin



3 2768 001 95147 8

DUDLEY KNOX LIBRARY