



Calhoun: The NPS Institutional Archive
DSpace Repository

Theses and Dissertations

1. Thesis and Dissertation Collection, all items

2006-09

Extending the tactical horizon networking
aircraft to enable persistent surveillance and
target development for SOF

Landreth, Kent A.; Glass, John C.

Monterey, California. Naval Postgraduate School

<https://hdl.handle.net/10945/2582>

This publication is a work of the U.S. Government as defined in Title 17, United States Code, Section 101. Copyright protection is not available for this work in the United States.

Downloaded from NPS Archive: Calhoun



Calhoun is the Naval Postgraduate School's public access digital repository for research materials and institutional publications created by the NPS community. Calhoun is named for Professor of Mathematics Guy K. Calhoun, NPS's first appointed -- and published -- scholarly author.

Dudley Knox Library / Naval Postgraduate School
411 Dyer Road / 1 University Circle
Monterey, California USA 93943

<http://www.nps.edu/library>



**NAVAL
POSTGRADUATE
SCHOOL**

MONTEREY, CALIFORNIA

THESIS

**EXTENDING THE TACTICAL HORIZON:
NETWORKING AIRCRAFT TO ENABLE PERSISTENT
SURVEILLANCE AND TARGET DEVELOPMENT FOR
SOF**

by

Kent A. Landreth
John C. Glass

September 2006

Thesis Advisor:
Second Reader:

David W. Netzer
Robert O'Connell

Approved for public release; distribution is unlimited

THIS PAGE INTENTIONALLY LEFT BLANK

REPORT DOCUMENTATION PAGE			<i>Form Approved OMB No. 0704-0188</i>
Public reporting burden for this collection of information is estimated to average 1 hour per response, including the time for reviewing instruction, searching existing data sources, gathering and maintaining the data needed, and completing and reviewing the collection of information. Send comments regarding this burden estimate or any other aspect of this collection of information, including suggestions for reducing this burden, to Washington headquarters Services, Directorate for Information Operations and Reports, 1215 Jefferson Davis Highway, Suite 1204, Arlington, VA 22202-4302, and to the Office of Management and Budget, Paperwork Reduction Project (0704-0188) Washington DC 20503.			
1. AGENCY USE ONLY (Leave blank)	2. REPORT DATE September 2006	3. REPORT TYPE AND DATES COVERED Master's Thesis	
4. TITLE AND SUBTITLE Extending the Tactical Horizon: Networking Aircraft to Enable Persistent Surveillance and Target Development for SOF		5. FUNDING NUMBERS	
6. AUTHOR(S) Maj Kent Landreth and Maj John Glass (USAF)		8. PERFORMING ORGANIZATION REPORT NUMBER	
7. PERFORMING ORGANIZATION NAME(S) AND ADDRESS(ES) Naval Postgraduate School Monterey, CA 93943-5000		10. SPONSORING/MONITORING AGENCY REPORT NUMBER	
9. SPONSORING /MONITORING AGENCY NAME(S) AND ADDRESS(ES) USSOCOM/J9 7701 Tampa Point Blvd MacDill AFB, FL 33621-5323		11. SUPPLEMENTARY NOTES The views expressed in this thesis are those of the author and do not reflect the official policy or position of the Department of Defense or the U.S. Government.	
12a. DISTRIBUTION / AVAILABILITY STATEMENT Approved for public release; distribution is unlimited		12b. DISTRIBUTION CODE	
13. ABSTRACT (maximum 200 words) <p>The NPS Tactical Horizon Extension Project objective is to define and demonstrate a concept by which task force-level commanders and below can obtain a persistent, over-the-horizon surveillance capability for the purpose of target development and other missions without tasking national or theater-level assets. Our goal is to increase the ISR capacity of units who normally would not rate the priority to task a Predator, Global Hawk, or U-2. There are two guiding tenets in developing this concept. First, the equipment and its control should be organic to the SOF unit or task force. Second, utilizing this capability should not require the soldier to carry any additional equipment into the field.</p> <p>Initial research led us to the idea of using networked unmanned aerial systems (UAS's) to generate an over-the-horizon surveillance capability for SOF. We demonstrated the concept by forming a network comprised of a forward ground team, an inexpensive, test-bed UAS equipped with an off-the-shelf video camera, a manned aircraft, and a tactical operations center (TOC). We attained connectivity through an ITT Mesh structure at 2.4 GHz, amplified to 1W. Researchers were from the Defense Analysis, Mechanical and Astronautical Engineering, and Information Sciences Departments. We conducted successful experiments through the USSOCOM-NPS Cooperative Field Experimentation Program.</p>			
14. SUBJECT TERMS UAS, UAV, Network Control, Tactical UAS/UAV, Beyond Line of Site, Mesh Networks, ISR,		15. NUMBER OF PAGES 83	
		16. PRICE CODE	
17. SECURITY CLASSIFICATION OF REPORT Unclassified	18. SECURITY CLASSIFICATION OF THIS PAGE Unclassified	19. SECURITY CLASSIFICATION OF ABSTRACT Unclassified	20. LIMITATION OF ABSTRACT UL

THIS PAGE INTENTIONALLY LEFT BLANK

Approved for public release; distribution is unlimited

**EXTENDING THE TACTICAL HORIZON: NETWORKING AIRCRAFT TO
ENABLE PERSISTENT SURVEILLANCE AND TARGET DEVELOPMENT
FOR SOF**

Kent A. Landreth
Major, United States Air Force
B.S. United States Air Force Academy, 1991

John C. Glass
Major, United States Air Force
B.S. United States Air Force Academy, 1992

Submitted in partial fulfillment of the
requirements for the degree of

MASTER OF SCIENCE IN DEFENSE ANALYSIS

from the

**NAVAL POSTGRADUATE SCHOOL
September 2006**

Author: Kent Landreth

John Glass

Approved by: Dr. David W. Netzer
Thesis Advisor

Dr. Robert O'Connell
Second Reader

Dr. Gordon McCormick
Chairman, Department of Defense Analysis

THIS PAGE INTENTIONALLY LEFT BLANK

ABSTRACT

The NPS Tactical Horizon Extension Project objective is to define and demonstrate a concept by which task force-level commanders and below can obtain a persistent, over-the-horizon surveillance capability for the purpose of target development and other missions without tasking national or theater-level assets. Our goal is to increase the ISR capacity of units who normally would not rate the priority to task a Predator, Global Hawk, or U-2. There are two guiding tenets in developing this concept. First, the equipment and its control should be organic to the SOF unit or task force. Second, utilizing this capability should not require the soldier to carry any additional equipment into the field.

Initial research led us to the idea of using networked unmanned aerial systems (UAS's) to generate an over-the-horizon surveillance capability for SOF. We demonstrated the concept by forming a network comprised of a forward ground team, an inexpensive, test-bed UAS equipped with an off-the-shelf video camera, a manned aircraft, and a tactical operations center (TOC). We attained connectivity through an ITT Mesh structure at 2.4 GHz, amplified to 1W. Researchers were from the Defense Analysis, Mechanical and Astronautical Engineering, and Information Sciences Departments. We conducted successful experiments through the USSOCOM-NPS Cooperative Field Experimentation Program.

THIS PAGE INTENTIONALLY LEFT BLANK

TABLE OF CONTENTS

I.	INTRODUCTION.....	1
A.	AN AGE OLD PROBLEM	1
B.	CURRENT ASSETS AND TACTICS	2
C.	A NEW CONCEPT.....	3
D.	A FEW WORDS ON CLASSIFICATION.....	4
II.	NETWORKS AND CONTROL.....	5
A.	CHOOSING AN ARCHITECTURE	5
B.	CHARACTERISTICS OF MESH	5
1.	The ITT Mesh Description.....	6
2.	Limitations of Mesh	6
C.	NPS RASCAL UAS AIRCRAFT AND CONTROL SYSTEM	7
1.	Mesh Range and Antenna Configurations	11
D.	AIRBORNE UAS CONTROL/DISTANCE EVALUATION.....	12
III.	TACTICAL HORIZON EXTENSION	19
A.	TACTICAL HORIZON EXTENSION BUILD-UP	19
1.	Tactical Horizon Extension Overview and Visual Representation (as published for TNT 06-4—Graphic Shown in Figure 14).....	19
B.	TNT 06-4, CAMP ROBERTS, CA—11-18 AUGUST 2006.....	20
1.	Equipment Set-Up and Testing.....	21
C.	TACTICAL HORIZON EXTENSION 1, TUESDAY 15 AUGUST 2006.....	23
1.	Transfer of Rascal Control to Pelican.....	26
2.	Post Crash Analysis	28
3.	Tactical Horizon Extension 2 Preparation	29
D.	TACTICAL HORIZON EXTENSION 2, THURSDAY, 17 AUGUST 2006.....	29
1.	Post Mission Analysis	30
E.	TACTICAL HORIZON EXTENSION 2A, AFTERNOON OF 17 AUGUST 2006.....	32
1.	Pelican in Control—Finds Target	35
2.	Ground Team in Control.....	37
3.	Bringing Rascal Home.....	40
IV.	RESULTS/FINDINGS.....	43
A.	OBJECTIVES	43

1.	Establish Effective UAS Control via Mesh network (airframe and camera) from Airborne and Remote Ground Stations: Also, add UAS waypoints and change flight parameters as well as manipulate on-board camera for target reconnaissance	43
2.	Evaluate Video Quality to Determine Aircraft and Sensor Capabilities	43
3.	Use the Mesh Network to Supply Real-Time Video to Pelican, Ground Team and TOC for Simulated ISR Target Development	44
4.	Manipulate Mesh Nodes to Simulate BLOS Between Parties	44
B.	MEASURES OF PERFORMANCE/ MEASURES OF EVALUATION	45
1.	Safely Transfer UAS and Camera Control Between GCS, Pelican and Remote Ground Team	45
2.	Evaluate Image Quality for Target Development and UAS/Sensor Control.....	45
3.	Functionality of Hardware and Software for Future Development and Field Application.....	46
V.	CONCLUSIONS	47
A.	OBSTACLES AHEAD	47
1.	The Network	47
2.	The Platform and Sensor.....	48
B.	THE WAY FORWARD: TECHNOLOGY AND DOCTRINE.....	49
C.	SUGGESTIONS FOR FURTHER RESEARCH.....	50
1.	Develop Options for ITT Mesh Networks: Antennas and Amplification.....	50
2.	Alter the SA Program to Allow a Single Node to Control Multiple UAS's.....	50
3.	Incorporate the Scan Eagle in Future Experiment Scenarios	51
D.	FINAL THOUGHTS	51
APPENDIX A.	EXPERIMENT 1 TEST PLAN	53
APPENDIX B.	31 JULY, 2006 FLIGHT TEST SUMMARY	55
APPENDIX C.	EXPERIMENT 2 TEST PLAN	57
APPENDIX D.	TACTICAL HORIZON DEMONSTRATION.....	59
	LIST OF REFERENCES.....	65
	INITIAL DISTRIBUTION LIST	67

LIST OF FIGURES

Figure 1. NPS Rascal UAS Physical Description	8
Figure 2. NPS UAS Avionics Bay	8
Figure 3. Manual Launch and Recovery of UAS	9
Figure 4. NPS Control Van Set-Up	9
Figure 5. SA Computer/UAS Interface and Controls.....	10
Figure 6. SA Computer/UAS Interface and Controls.....	11
Figure 7. Antenna/Distance Performance Evaluation Set-Up	12
Figure 8. UAS Ground Control Rehearsal	13
Figure 9. UAS Ground Rehearsal Antenna Set-Up	13
Figure 10. First Flight Test Set-Up—Rascal Pedestal	15
Figure 11. First Flight Test Set-Up—Rascal Set-Up.....	15
Figure 12. Pelican Antenna Placement	16
Figure 13. Pelican Computer Operator Station	16
Figure 14. Tactical Horizon Extension Demonstration Orientation	20
Figure 15. Target Construction	21
Figure 16. Initial Connectivity Test Set-Up.....	22
Figure 17. Tactical Horizon Extension 1—Pelican	24
Figure 18. Tactical Horizon Extension 1—Ground Team	25
Figure 19. Rascal and Pelican in Flight	25
Figure 20. First Flight Crash	27
Figure 21. Rascal Damage—Post Crash	27
Figure 22. Accident Telemetry.....	28
Figure 23. Incorrect Target Altitude in SA	31
Figure 24. Correcting Target Altitude	32
Figure 25. Tactical Horizon Extension 2A Take-Off.....	33
Figure 26. Canyon Road from Piccolo	34
Figure 27. Canyon Road from Rascal	34
Figure 28. Pelican Identifies Target	35
Figure 29. Zooming in on Target.....	36
Figure 30. Pelican Transfer of Control to Ground Team	37
Figure 31. Ground Team Control—Orbit of Target	38
Figure 32. GCS Real-Time View of Ground Team Control and Video.....	38
Figure 33. Pelican Real-Time View of Ground Team Control and Video.....	39
Figure 34. Evaluating Mesh Distances	40
Figure 35. Ground Team—Making a New Waypoint	41
Figure 36. Transfer of Control from Ground Team to Pelican.....	41

THIS PAGE INTENTIONALLY LEFT BLANK

ACKNOWLEDGMENTS

Although there are two principal authors for this paper, this project would not have been successful without the insights and assistance of many people. From the beginning Dr David W. Netzer, our thesis advisor, provided us with sage guidance, expansive background and contact information, and nearly unlimited access to his department's resources. The most helpful of these resources were, of course, the people. Dr Alex Bordetsky was instrumental in formulating both the conceptual and technical aspects of the experiments. Eugene Bourakov has forgotten more about network technology than the rest of us will ever know and is an absolutely critical node in the network that is the NPS TNT research team. Dr. Kevin Jones can build a UAS fully integrated with network control, autopilot, and camera out of a kid's RC airplane kit, rubber band and all. Furthermore, he can crash it to pieces in the morning and have it fixed and flying before the afternoon experiment. Dr. Vladimir Dobrokhodov, the indefatigable programmer, integrated the autopilot with the research network (for which it was not designed) and tried his best to teach us how to power up the control van by ourselves. Alas, he was ultimately unsuccessful in this. These talented researchers proved innovative and tireless. Without their contributions this concept would never have gotten off of the cocktail napkin, much less the ground.

Aside from these primary actors, there were several other key people who assisted with numerous projects not because they had to, but because they simply wanted to help: Karl Gutekunst, Dr. Isaac Kaminer, Mike Clement (Eugene's protégé), Don Meeks, and Marianna Verrett. Their generous assistance was indispensable in this project.

This concept was inspired through interviews with SOCOM component command operators, commanders, and acquisitions personnel whose names and offices we cannot mention here.

Finally, we owe a sincere debt of gratitude to Dr. Robert O'Connell, our teacher and second reader. His astute observations, prodigious historical knowledge, and uniquely broad perspective helped to shape this concept.

THIS PAGE INTENTIONALLY LEFT BLANK

EXECUTIVE SUMMARY

The NPS Tactical Horizon Extension Project objective is to define and demonstrate a concept by which task force-level commanders and below can obtain a persistent, over-the-horizon surveillance capability for the purpose of target development and other missions without tasking national or theater-level assets. Our goal is to increase the ISR capacity of units who normally would not rate the priority to task a Predator, Global Hawk, or U-2. There are two guiding tenets in developing this concept. First, the equipment and its control should be organic to the SOF unit or task force. Second, utilizing this capability will not require the soldier to carry any additional equipment into the field.

Initial research led us to the concept of using networked unmanned aerial systems (UAS's) to generate an over-the-horizon surveillance capability for SOF. We demonstrated the concept by forming a network comprised of a forward ground team, an inexpensive, test-bed UAS equipped with an off-the-shelf video camera, a manned aircraft, and a tactical operations center (TOC). We attained connectivity through an ITT Mesh structure at 2.4 GHz, amplified to 1W. We found we could launch the UAS from a rear area, guide it to a specific target and send video of that target to both forward operators and TOC personnel. One should note here that we chose this particular network composition because the NPS researchers were already using mesh cards and antennas in their UAS's. We do not advocate this exact system for use in the field for several reasons including limited range between nodes and current fragility of the mesh network. If SOCOM is interested in exploring this concept, future research will require a coherent concept of employment as well as an assessment of technology.

The Tactical Horizon Extension Project was a joint endeavor between the Defense Analysis, Mechanical and Astronautical Engineering, and Information Sciences Departments. We conducted successful experiments through the USSOCOM-NPS Cooperative Field Experimentation Program.

THIS PAGE INTENTIONALLY LEFT BLANK

I. INTRODUCTION

A. AN AGE OLD PROBLEM

On the night of 20 November 1970, Colonel Arthur ‘Bull’ Simons made the command decision to launch the now legendary Son Tay raid in an attempt to rescue between 50 and 100 US Prisoners of War (POW’s) from an isolated camp 28 miles west of Hanoi. In executing Operation Kingpin, Colonel Simons sent over 200 men and 116 aircraft into harm’s way. He was acting on hazy, 3-day-old intelligence received at the last minute. In the course of this brilliantly executed raid, the assault force made an important discovery. The North Vietnamese had moved the entire group of POW’s from Son Tay to Hanoi long before the raid.¹ Clearly, timely intelligence is critical to the target development phase of special operations missions. Of course this is well-known.

History is replete with examples of military forces armed with incomplete and/or inaccurate intelligence, which caused them to act when they shouldn’t have and not act when they should have. Examples of this abound, from Troy (cool horse) to Agincourt (what longbows?) to Normandy (hold the panzers). The quest for timely, accurate intelligence has occupied the minds of commanders since the advent of organized military activity. This has not changed in the 35 years since the Son Tay raid.

Today a significant portion of our Global War on Terror (GWOT) is an overt military campaign involving more than 150,000 men in arms and daily action against multiple, loosely-organized, unconventional enemy groups utilizing guerrilla tactics to control native populations, attrite our forces, and erode our will to fight. The principal areas of operation in the current phase of this war are Afghanistan and Iraq. Military commanders in these theaters are charged with monitoring just over one million square kilometers of diverse terrain for all manner of enemy activity. Due to the unconventional nature of the enemy and our emphasis on hard or ‘kinetic’ solutions, our current strategy for Special Operations Forces (SOF) in this war focuses upon finding and targeting these irregular groups and, occasionally, a single member or leader of a group.²

¹ Lieutenant General Leroy J. Manor’s description of the Son Tay raid, retrieved from <http://www.vietnamwar.com/sontayprisonraid.htm>.

² Chairman of the Joint Chiefs of Staff, “National Military Strategic Plan for the War on Terrorism,”

B. CURRENT ASSETS AND TACTICS

To gain the information required to prosecute such missions, we have fielded numerous Intelligence, Surveillance, and Reconnaissance (ISR) mechanisms to monitor various geographic areas for all types and levels of enemy activity. As the global superpower with a historic penchant for technology-based weaponry, our array of ISR equipment is impressive. At the strategic (national) level, we employ a robust constellation of satellites to monitor portions of the Earth in several mediums, including radar, infra-red (IR), and electro-optical (EO). At the theater level, we employ “multi-int” systems such as the Lockheed U-2 and Northrop QR-4 Global Hawk to gather both signals intelligence (SIGINT) and imagery intelligence (IMINT). Also at the theater level, unmanned airborne platforms, such as the General Atomics RQ-1 Predator, gather IMINT to protect friendly positions and attempt to expose enemy ones. With a substantial loiter time and a full motion video (FMV) capability; the Predator has become the SOF commander’s platform of choice to support tactical operations, particularly direct action.³ Below the task force level, several types of Unmanned Aerial Systems (UAS’s) are now available to gather tactical IMINT to support all manner of military operations from convoy protection to perimeter defense to manhunting. There is also a new generation of Unmanned Ground Vehicles (UGV’s) in production to support perimeter defense as well as urban reconnaissance in advance of flesh-and-blood soldiers. Rounding out this array of ISR technologies is a collection of Remote Sensors (RS’s) which can be placed or airdropped on the ground in a given area for the purpose of passively detecting enemy activity. Small, inexpensive, lightweight, and easily disguised, such sensors offer a rugged, dispersed, and persistent detection capability. But because these sensors must be retrieved or at least overflown in order to reap the information they have collected, they lack the real-time or even near-real-time intelligence that the modern command echelon craves.⁴

(2006): 22-29, <http://www.defenselink.mil/qdr/docs/2005-01-25-Strategic-Plan.pdf> , September, 2006.

³ This information was gained through several interviews with operations personnel from various components of SOCOM in March of 2006.

⁴ This information was gained through an afternoon of conversations with acquisitions and programming personnel at SOCOM in March of 2006.

At the tactical level of operations, FMV is king. It is the most desired medium through which decision makers can develop and assess a target or situation for action. FMV is real-time and requires little or no interpretation by a trained imagery analyst. It is essentially television. Virtually every asset which can provide FMV or even near-real-time imagery over the horizon or Beyond-Line-of-Sight (BLOS) falls into the category of Low Density High Demand (LD/HD) systems. In other words, the demand for the ISR products of these assets (U-2, Global Hawk, Predator, etc.) outweighs the limited capacity of the relatively low number of these very expensive platforms.⁵ Thus far, the special operations community's answer for this has been to simply claim more assets.⁶ But even with the Department of Defense's added emphasis on special operations, a gap exists between what is needed by special operations personnel to develop potential targets, and what is available to them.⁷ We conceived the Naval Postgraduate School Tactical Horizon Extension Program in an effort to close this gap.

C. A NEW CONCEPT

We propose in this paper to introduce a concept by which a SOF task force or smaller organization can utilize existing, low-cost technologies with Line-of-Sight (LOS) links to obtain a BLOS surveillance capability for the purpose of developing potential targets or objectives, without tasking theater-level or above assets. In short, we will demonstrate that tactical ground forces can establish a network comprised of one or more UAS's as well as manned aircraft and other ground teams to help fill this shortfall in ISR capability. Furthermore, this concept combined with emerging UAS platforms will enable the small, forward maneuver team to utilize UAS ISR output, including direct access to raw FMV, without physically carrying the system on their backs or exposing themselves in the target area. Finally, this capability can be organic to the task force or lower headquarters, thereby increasing that unit's autonomy in launching and tasking its own aircraft, as well as exploiting the resultant IMINT or SIGINT.

⁵ Don Snyder, et al. Supporting Air and Space Expeditionary Forces: Capabilities and Sustainability of Air and Space Expeditionary Forces (Santa Monica: Rand, 2006), 3.

⁶ This information was gained through several interviews with operations personnel from various components of SOCOM in November of 2005.

⁷ Taken from non-attribution comments of a SOCOM component operator upon his return from Afghanistan, April 2006.

In proving this concept, we will first explain its origins and how our initial research pointed to a need for increasing the ISR capacity of smaller SOF units. Then we will develop a scenario in which this BLOS surveillance capability could aid SOF forces in finding and fixing a given target. We will test this scenario in the field as part of the USSOCOM-NPS Cooperative Field Experimentation Program utilizing existing NPS assets and on-going UAS research. Finally, we will present the results of these tests with findings, feedback from USSOCOM, and recommendations for further research.

D. A FEW WORDS ON CLASSIFICATION

This paper is unclassified despite the fact that initial research pointed to several classified applications of the concept. Upon immersing ourselves in the USSOCOM-NPS Cooperative Field Experimentation Program, we found that our program overlapped other existing research efforts and that several principal players on the technical side of these programs were foreign nationals and unable to obtain security clearances. These engineers proved absolutely essential to the technical development of this concept, namely networking UAS's. Without their outstanding ability, persistence, and technical innovation we would not have been able to conduct successful field experiments. It is for the above reasons that all of the work contained within remains unclassified.

II. NETWORKS AND CONTROL

A. CHOOSING AN ARCHITECTURE

The appeal of using certain technologies, besides immediate availability, was the ability to simulate a capability that could be translated from limited test capabilities to a robust military application with minimal R&D and/or cost. The ITT Mesh network was one of those technologies which held significant promise for demonstrating the Tactical Horizon Extension concept by tying together ground and air UAS control nodes by means of a self-forming/self-healing network. Mesh was already in use by NPS for other applications, so it was known and available. The real appeal was highlighted when Eugene Bourakov⁸ explained the only equipment required to join the network was a laptop computer with a PCM CIA mesh network card, connected to a small 2.4GHz omni antenna (smaller devices, such as PDAs, could and have been used but were unavailable for our use).⁹ The significance of the small equipment footprint cannot be overstated. Aircraft and soldiers in the field are being overburdened with every new piece of technology that comes along (some with little value)—increasing weight, power requirements and decreased mobility. Our vision is that Tactical Horizon Extension capability can be added to any aircraft or ground team with few if any of the aforementioned penalties.¹⁰ The control mechanism would be Situational Awareness (SA) software developed by Eugene Bourakov that works through the mesh network and video is viewed via Pelco-Net software.

B. CHARACTERISTICS OF MESH

Since the systems used to demonstrate the Tactical Horizon Extension concept are not intended for fielding; working knowledge vs. engineering knowledge of the equipment should be more than adequate to support ours and follow-on research.

⁸ Eugene Bourakov is a Research Associate in the Information Sciences Department at NPS.

⁹ Initial discussion in Mar 06 with Eugene Bourakov, Dr. Dave Netzer, Dr. Kevin Jones and Dr. Vladimir Dobrokhodov regarding potential architecture solutions.

¹⁰ Other combinations of control and data transfer were discussed (i.e. mesh control, 802.16 video link), but multiple systems drastically increased the logistical footprint and fell from consideration.

1. The ITT Mesh Description¹¹

“Mesh” as we refer to it is commercial-off-the-shelf-technology (COTS) using 2.4GHz wireless network cards with an internal amplification of 200mW. Data transfer rates of 6MBps are possible when using data-burst modes, but 1MBps is realistic for streaming data/video data transfer applications with multiple nodes. Unlike a hub and spoke network where users must go through the hub or server to access data, the mesh allows for any user to pull data from any other user as long as there is a path of connectivity (data may take several “hops” along other connected systems before reaching the requestor’s terminal). As new members join or members leave the network, the paths will change to include the new addition or re-route to fill in for the lost one.

2. Limitations of Mesh

The advantages of a self-forming, self-healing network create one of the most significant limitations as well. Since there is no server, each client on the network pulls data through a separate conduit, meaning the overall bandwidth is not shared by each user; it is divided by each user. Even when two users are requesting the same data from any source, separate data streams are created instead of shared, effectively cutting the band width in half. Added strain on the data pipeline is created by network “polling” or “handshaking” between nodes, especially with dozens of active clients, hence this mesh characteristic can overwhelm the system with the “overhead” of making the computers talk. With only 1MB/sec available and FMV users and equipment demanding anywhere from 100KB/sec to 10MB/sec, bandwidth management and user access become critical to prevent crippling network data flow. It should be noted, UAS control signals are also sharing the same pipeline but the data transfer requirements are small enough to be considered negligible.

Another limitation that needed resolution before deciding on mesh as our architecture for demonstration purposes was power (wattage) and corresponding range/distance between clients. At 200mW, the mesh card proved capable of networking within 1 or 2 kilometers, but our demonstration concept would need to double or quadruple that distance. Commercial 2.4GHz/1W (FCC limit) amplifiers were purchased

¹¹ Mesh information accessed from http://www.motorola.com/governmentandenterprise/contentdir/en_US/Files/General/data_sheet_mea.pdf (5 Sep 2006).

for the manned aircraft (called the Pelican), Ground Control Station, Ground Team and Rascal UAS, to increase range but exactly how far was an unknown that created our first field test requirement. Closely coupled to the range issue was what type of antenna would provide the greatest range while still providing the most reliable coverage pattern for use on aircraft and moving vehicles. Range capability became one of the most difficult pre-requisites to nail down prior to the Tactical Horizon Extension demonstration.

The last limitation (for our purposes), and one which is the most difficult to control or change—is the operational frequency—2.4MHz. The number of commercial systems that use this frequency band is enormous; everything from cordless phones to wireless routers clog the airways and can potentially disrupt the mesh with subtle or potentially catastrophic results. Mesh was found to be very fragile in this regard, thus creating an almost sterile 2.4MHz environment was important to the success of the Tactical Horizon Extension experiment (ITT has the same mesh capability in systems using frequencies other than 2.4MHz, which may reduce these problems in future tests).¹² The initial test concepts can be found in Appendix 1.

C. NPS RASCAL UAS AIRCRAFT AND CONTROL SYSTEM

The Rascal UAS is a highly modified SIG Rascal 110 remote control airplane. The plane is designed for docile /forgiving handling characteristics and its fuselage leaves ample room for additional equipment (Figures 1 & 2). In the NPS configuration, the aircraft is launched manually with a standard RC type controller tied into the Piccolo autopilot (with an amplified antenna for added range, Figure 3). Control is passed from the manual Piccolo control (via the RC controller) to the computer control (Figure 4), where control inputs and telemetry are passed via 900MHz link.

¹² The problems identified with mesh are areas of research to be pursued if the Horizon Extension project were to be pursued for potential military applications.

NPS Rascal UAS Physical Description

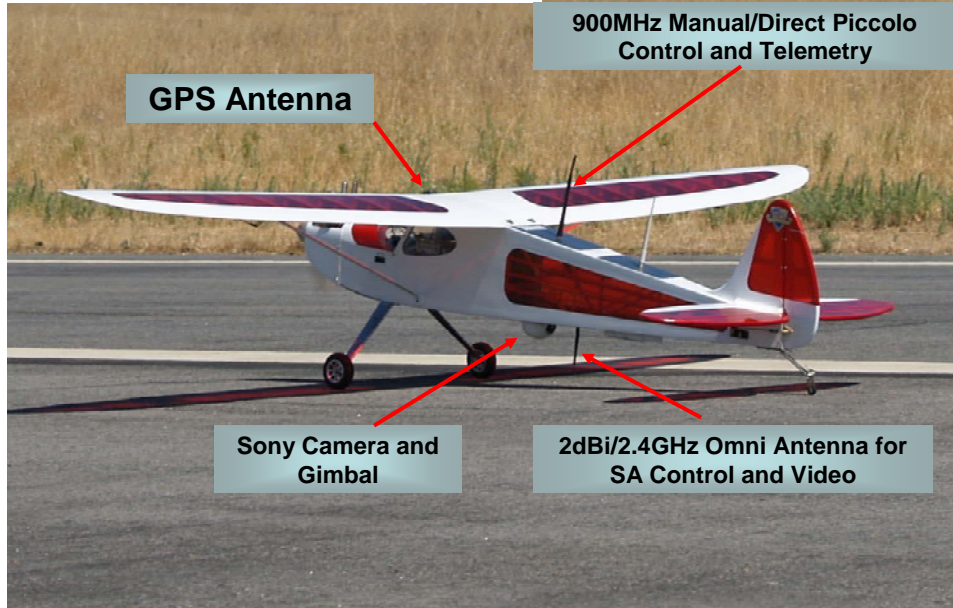

Figure 1. NPS Rascal UAS Physical Description

Rascal Avionics Bay

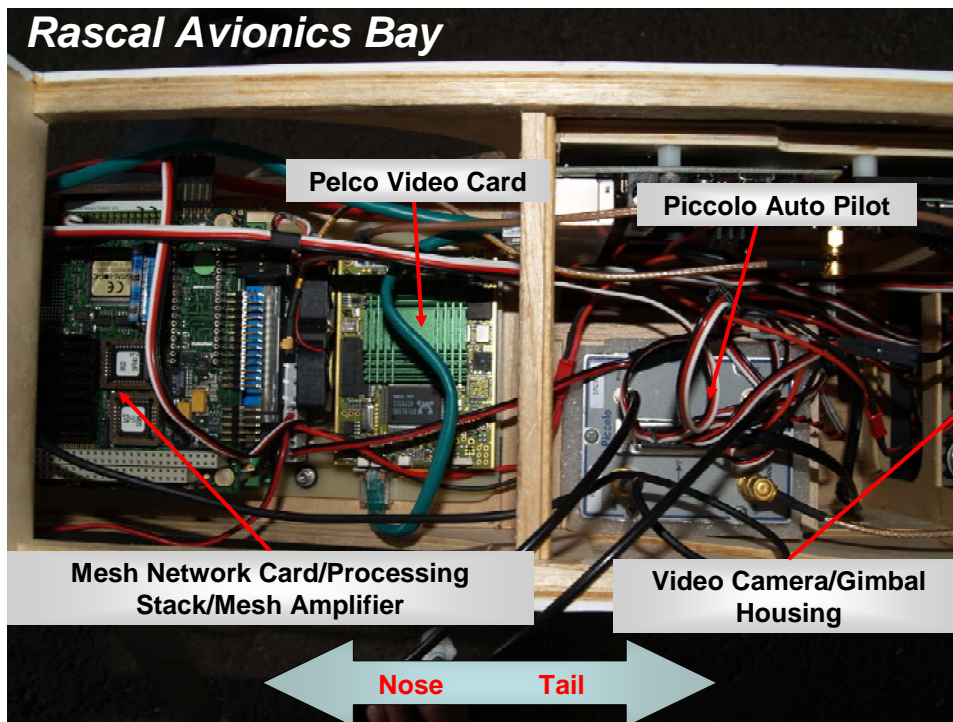

Figure 2. NPS UAS Avionics Bay

**Manual Launch/ Recovery
of NPS Rascal UAS**



Figure 3. Manual Launch and Recovery of UAS

NPS Ground Control Van

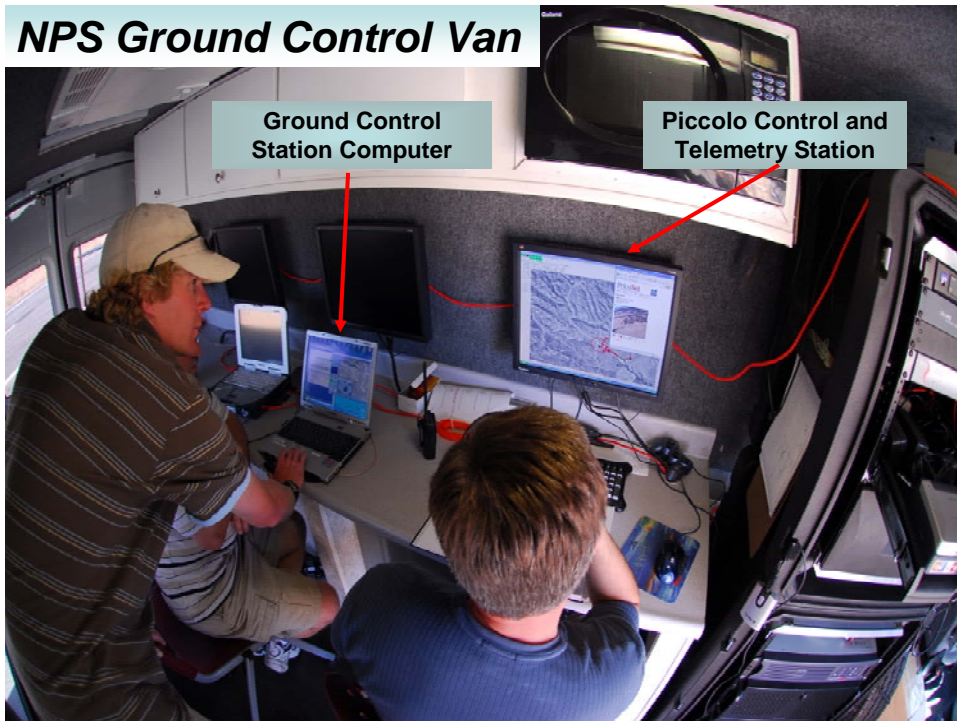

Figure 4. NPS Control Van Set-Up

The UAS can then be controlled via SA through the mesh 2.4GHz network ground control station¹³, whereas the video gimbal can be controlled and images passed back through the same architecture. The SA ground control station can also monitor what commands are input to the SA system and on to the Piccolo autopilot. Figures 5 and 6 shown the visual presentations and control aspects of the SA and Pelco Net software that were used by the GCS, Pelican and ground team. Since Tactical Horizon Extension is not advocating these software programs for potential fielding, general knowledge of their function is all that is required to further our discussion.

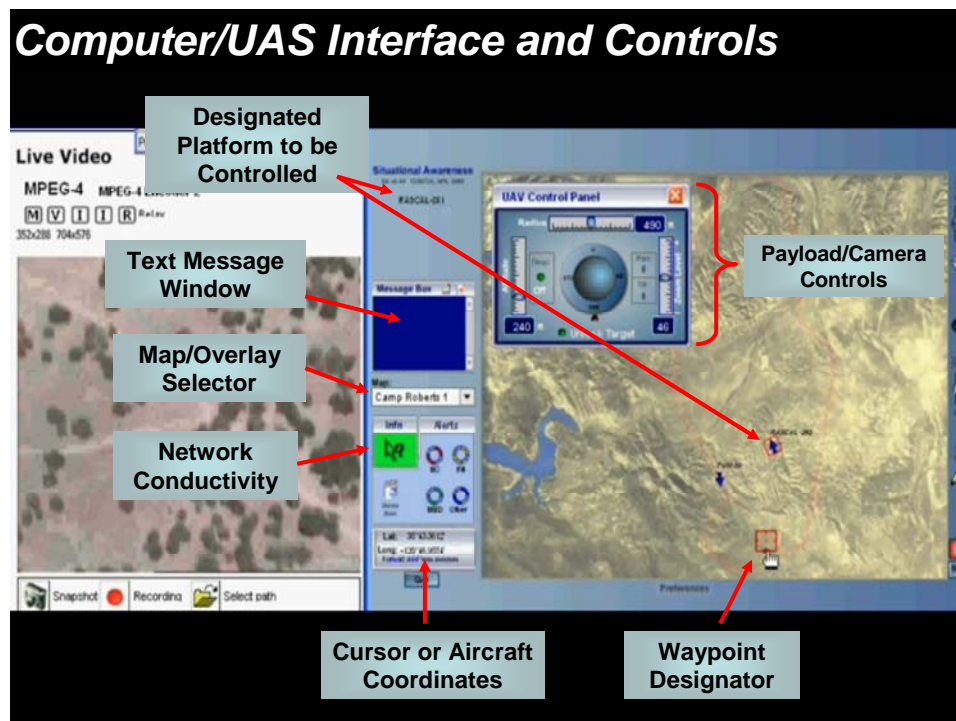

Figure 5. SA Computer/UAS Interface and Controls

¹³ In our set-up, the SA ground control station does not refer to a large package of significant capability or size. It is simply a similarly configured laptop as the Pelican and ground team but is co-located with the Piccolo ground control station.

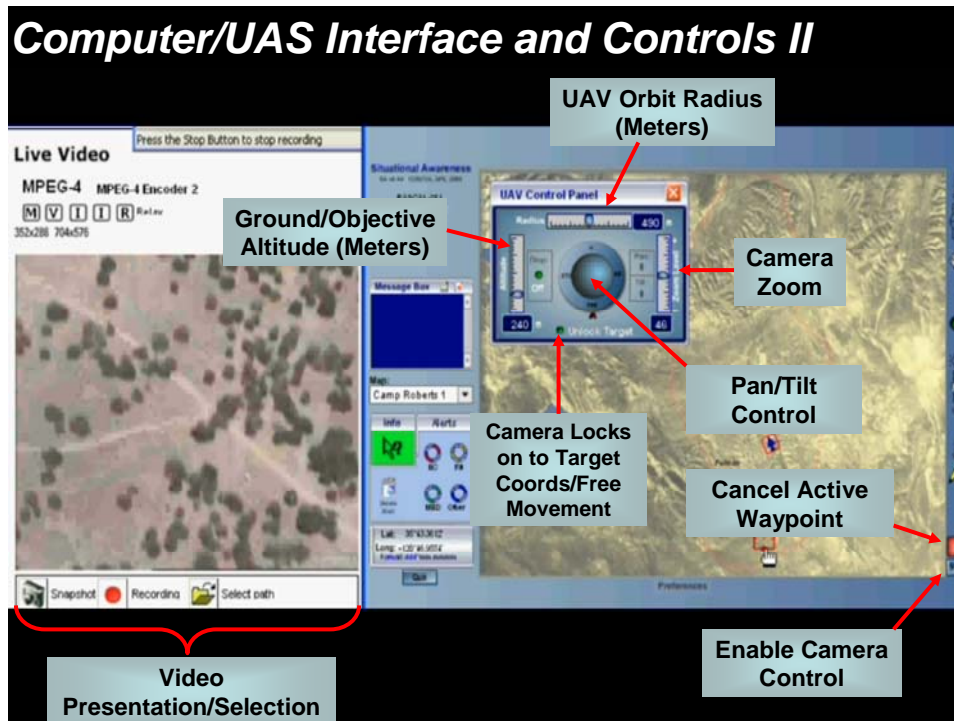

Figure 6. SA Computer/UAS Interface and Controls

1. Mesh Range and Antenna Configurations

The Tactical Horizon Extension demonstration was to be conducted at Camp Roberts Army National Guard Post (10 miles north of Paso Robles, CA) as part of the quarterly USSOCOM-NPS Cooperative Field Experiment Program. So, to replicate demonstration conditions, initial range and antenna tests were attempted at Camp Roberts by dovetailing off of other tests, which required the use of the NPS Rascal UAS. Connectivity would be evaluated by subjective evaluation of Rascal video quality and by “pinging” mesh and video IPs to evaluate packet delivery and response loss and times. A Ground Control Van Accident, engine trouble, winds, computer problems and experiment priority left literally no data collected prior to TNT 06-3 in June. Major Glass spent two days trying to establish network connections with Rascal, both on the ground and in the air, using different antennas at different distances (from ½ to 2 ½ km) with no or poor/unusable video quality. Major Landreth spent the following two days repeating the tests using the set-up shown in Figure 7. Connectivity was established with Rascal on the ground/air (in an orbit around the runway) and good video (at 500KB/sec) was

maintained at 2km using a 7dBi omni antenna and 13dBi patch directional antenna, but time constraints limited any further evaluation of other antennas at other distances.

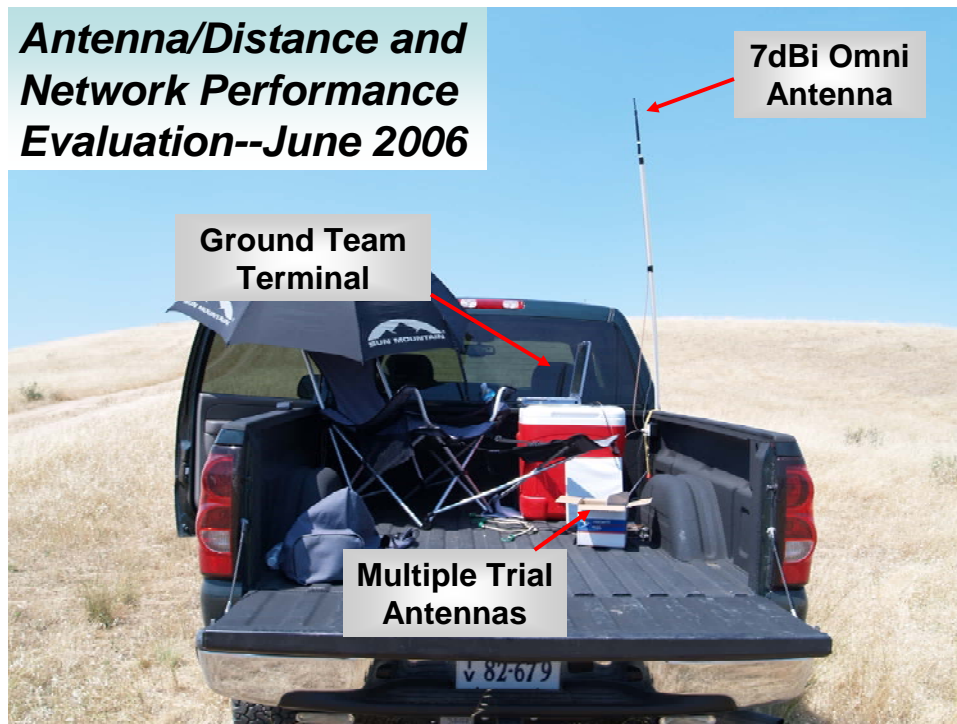

Figure 7. Antenna/Distance Performance Evaluation Set-Up

D. AIRBORNE UAS CONTROL/DISTANCE EVALUATION

The 27th of July presented another opportunity to gather data and attempt to transfer control of the UAS while the aircraft was in an orbit around the McMillan Airfield at Camp Roberts (set-up depicted in Figures 8 & 9).

***UAS Control Ground Rehearsals
and Antenna/Distance Evaluation
27 July 2006***

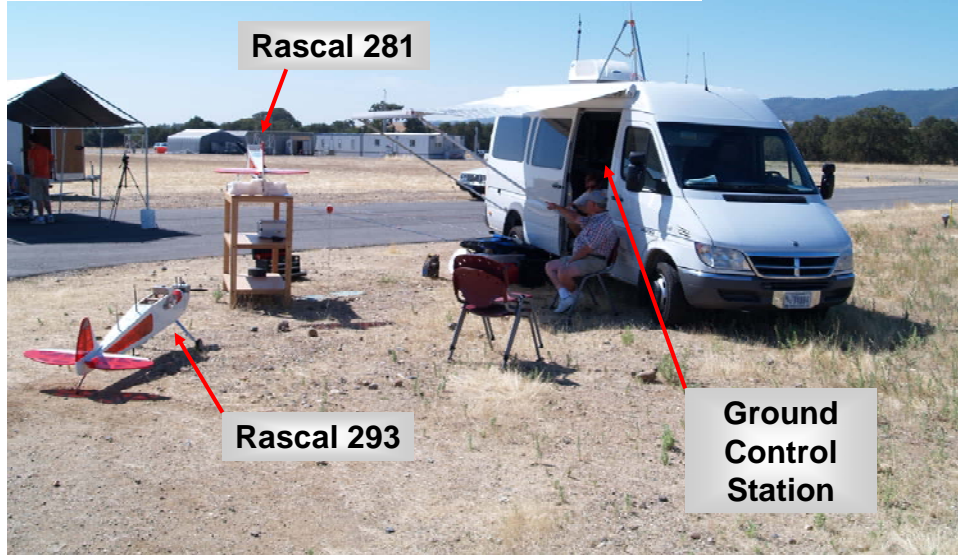

Figure 8. UAS Ground Control Rehearsal

***UAS Control Ground Rehearsals
and Antenna/Distance Evaluation
27 July 2006***



Figure 9. UAS Ground Rehearsal Antenna Set-Up

While conducting pre-flight conductivity checks with Rascal, we were unable to get a satisfactory video picture on the ground, and as the day wore on winds picked up and we were unable to fly. Initial assessment of the problem indicated a possible overheating problem with the Pelco video card, for which, we had no spare (ambient temperature was in excess of 105 deg. F.). So the day of practice and data collection turned into a scouting expedition for a demonstration target location and observation post (OP) for the ground team. Target selection was based on easily identifiable dirt road intersections in the floor of a shallow valley that would ensure the Rascal UAS would remain BLOS of the ground control station as it orbited the target and the OP was not in visual contact with the target and BLOS with the GCS (detailed description to follow in the demonstration sections).

After multiple attempts over several weeks to collect the required data with only a few data points collected, the decision was made to test the ability of a manned airborne platform (Pelican with Major Glass) to control a static Rascal UAS at Marina airfield just north of Monterey (home airport of the Pelican). To this point, few tests had been dedicated to the range/connectivity issue and jumping to an airborne test might seem bold when evaluating a new concept. But enough was known, based on previous NPS experience, and the time constraints were significant enough to make this a reasonable and necessary step forward. The goals were to evaluate network conductivity and video quality using 2dBi omni antennas on both the Pelican and Rascal as pictured in Figures 10, 11, 12 & 13.

**First Flight Test
with Pelican and
Static Rascal
28 Jul 2006**



Figure 10. First Flight Test Set-Up—Rascal Pedestal

**First Flight Test
with Pelican and
Static Rascal
28 Jul 2006**

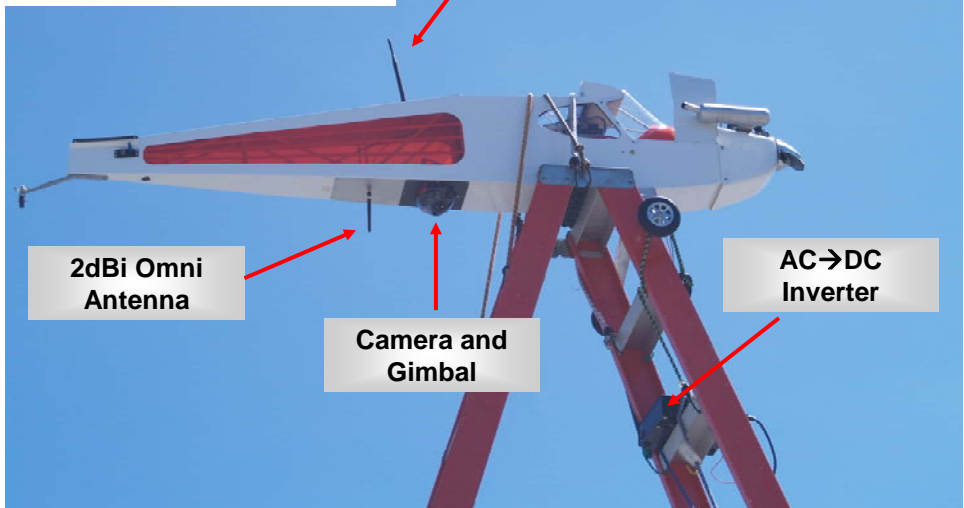

Figure 11. First Flight Test Set-Up—Rascal Set-Up

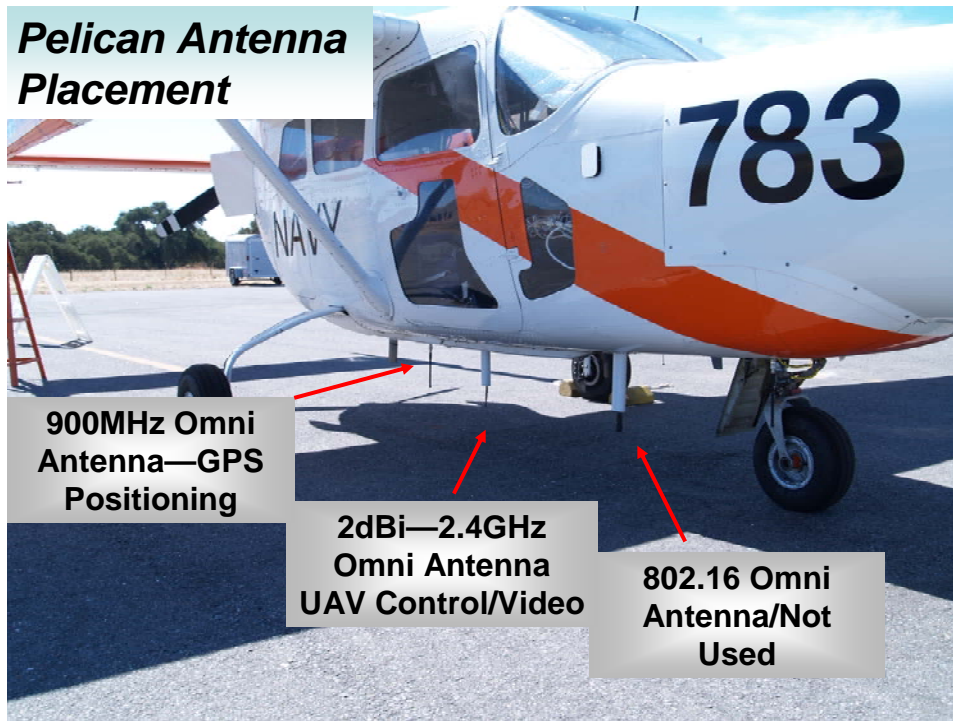

Figure 12. Pelican Antenna Placement



Figure 13. Pelican Computer Operator Station

The test was highly successful, exceeding any of the participants' expectations. Connectivity, camera control and high quality video were maintained beyond three miles and at altitudes up to 2,000ft. The Pelco video card problems seemed to have resolved themselves as the Pelican station did not experience any of the problems previously encountered at Camp Roberts. Again, this led us to suspect possible overheating problems as the cause of the video issues because everything worked as advertised and the temperature was a cool 58 deg. F. A complete summary can be found in Appendix 2.¹⁴ We were unable to test different antenna configurations; however, based on the scenario devised for Camp Roberts, the network performance recorded at the Marina Airfield gave us confidence mesh could support the Tactical Horizon Extension demonstration.

¹⁴ Notes and summary of the test were produced by Mr. Karl Gutekunst (NPS).

THIS PAGE INTENTIONALLY LEFT BLANK

III. TACTICAL HORIZON EXTENSION

A. TACTICAL HORIZON EXTENSION BUILD-UP

The successful test at Marina and a shortage of time forced us into using the data collected on distances and video quality at Marina as the baseline for our entire experiment at Camp Roberts on 15 & 17 Aug (the focal experiment for TNT 06-4). In building the schedule however, three practice sessions were built into the week in order to practice transfer of control of NPS Rascal prior to the demonstrations. It should be noted that since no other antenna configuration had been successfully tested, the Pelican and Rascal would use 2dBi omni antennas and the ground team would use a 3dBi antenna which would provide the most conservative antenna selection at the expense of gained distance.¹⁵ The original Tactical Horizon Extension demonstration test synopsis is included as Appendix 3, and the final synopsis/diagram (below) and timeline, as distributed to SOCOM and all other TNT-06-4 participants, is included in Appendix 4.

1. Tactical Horizon Extension Overview and Visual Representation (as published for TNT 06-4—Graphic Shown in Figure 14)

“SOLIC Thesis students Major John Glass and Major Kent Landreth have joined with the NPS SUAV Research Team and the NPS CENETIX to demonstrate the transfer of UAS/UAV control between a ground control station (GCS/control van), a manned fixed wing aircraft (CIRPAS Pelican) and a forward deployed ground team, to create target development capability using tactical ISR assets. The intent is to use a wireless ITT Mesh network (2.4GHz) amplified to 1W in order to control the UAS and view streaming video. The Pelican will have an operator (Major Glass), laptop configured with mesh card and 1 W amplifier connected to an externally mounted 2 dBi antenna. The forward deployed ground team will have a similarly configured laptop with a portable 3 dBi antenna. The UAS will be launched manually and control passed to the GCS, who will then assume aircraft/payload (camera) control via the NPS developed Situational Awareness software and server. The Pelican will assume UAS control via SA and recon the objective area—simulating BLOS from the GCS—and then send the UAS to a pre-planned waypoint, where the ground team will assume control through the SA

¹⁵ The tests at Marina gave sufficient range to meet the distances previously established between ground control station and Target at Camp Roberts.

server and return the UAS to the objective area for further target development. The TOC will monitor video and provide scenario updates based on information gathered through mesh video feeds. UAS control will then be returned to the Pelican and GCS respectively for a manual landing at the airfield.”¹⁶

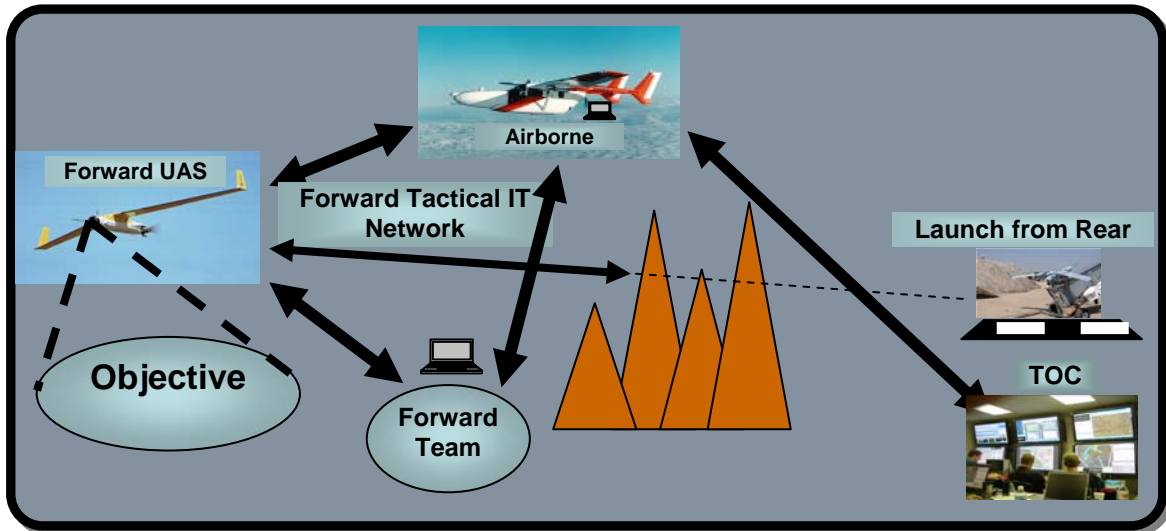

Figure 14. Tactical Horizon Extension Demonstration Orientation

B. TNT 06-4, CAMP ROBERTS, CA—11-18 AUGUST 2006

Tactical Horizon Extension demonstration dates were the 15th and 17th of August, but preparations began on Aug 11th as we built the target and prepared for at least three test flights prior to the first demonstration on the 15th. Target design was meant to provide the maximum contrast with the surrounding terrain, and to give the best chances of finding and maintaining the target within the camera field of view (Figure 15). It is important to note that we would not anticipate “searching” for a target; instead we envisioned a ground team knowing with a good deal of precision where the target is located and then using the UAS to develop it, not find it. Further, we had yet to successfully control both the UAS and camera via our computers so we wanted to make our objectives reasonable for the first time out.

¹⁶ Taken from USSOCOM-NPS Cooperative Field Experiment TNT 06-4 Experiment description, document produced by Dr. Dave Netzer.

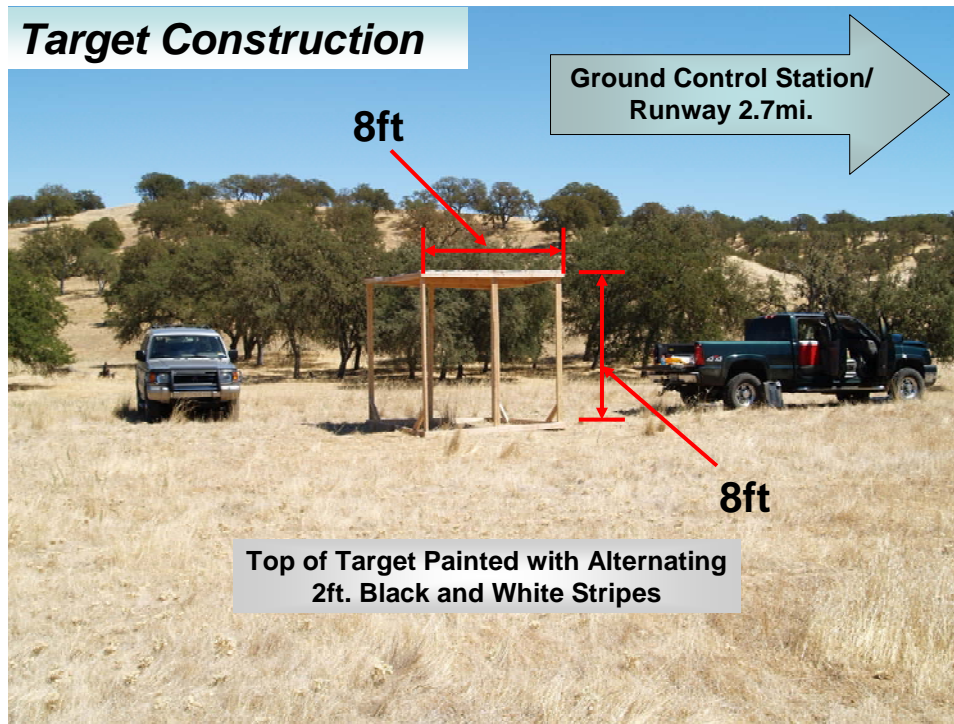

Figure 15. Target Construction

1. Equipment Set-Up and Testing

Once the target had been constructed on Fri, 11 Aug., Saturday 12 Aug. was meant for ground testing the aircraft, antennas, and computers to ensure we were ready to tackle the test flights on Sunday, 13 and Monday, 14 August. Using the configuration seen in Figure 16, each system was tested for network connectivity and video presentation using Rascal 293 (on the ground only). The Pelican aircraft was not scheduled to arrive until Monday morning, so all tests of the airborne computer were conducted with a similar setup to the one used by the ground team. Right away problems were noted with the video presentation, and most of the rest of the day was spent troubleshooting potential problems with no identified solution found.

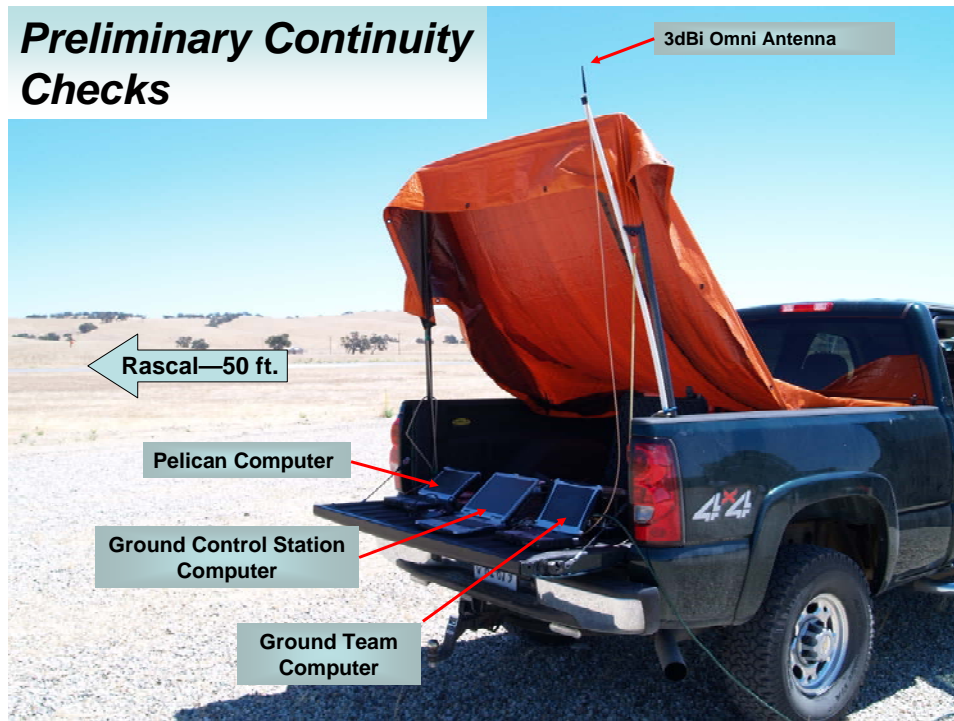

Figure 16. Initial Connectivity Test Set-Up

Not all was going well in other parts of the experiment: Rascal 281, the back-up aircraft for the Tactical Horizon Extension flights, damaged its landing gear on take-off in strong cross-winds and upon landing the gear completely collapsed, slightly damaging the fuselage. At least 24 hours would be needed to repair the undercarriage. Following this incident Dr. Dave Netzer (Thesis Advisor) made the wise decision to delay any test flights prior to the demonstration in order to focus on correcting the video transmission problems and save the primary aircraft for the demonstrations on Tuesday and Thursday of the following week.

Working towards fixing the video transmission problem, Dr. Kevin Jones replaced the Pelco card on board the Rascal with no change in the video output. Further discussion led us to consider some sort of unintentional electronic interference--due to the high amount of RF energy in and around the airfield.¹⁷ It was decided on Sunday to take Rascal 293 out to the target and evaluate our connectivity with the UAS perched on top of the target structure (similar to the Marina set-up). Results were good with the Pelican and Ground Station computers, but the ground team was still limited to poor video

¹⁷ Dr. Netzer had a thorough frequency de-confliction plan but it was hard to monitor all sources of RF energy.

quality. In dialogue with Eugene Bourakov, it was decided to replace the ground team computer with an identically configured one. The results were immediate and improvement substantial . . . good quality video could be maintained by each of the computer systems while controlling the camera on board Rascal 293. Sunday came to an end with fully functional components and the plan would be to test them in their respective Tactical Horizon Extension configurations on Monday.¹⁸

Early morning fog delayed the arrival of the Pelican, but the time was used to verify the solid video pictures of the previous evening, and results were once again positive. After Pelican arrival, the afternoon was spent testing the connectivity of the Pelican computer after installation into the aircraft, the results of which were as good as they had been previously in Marina. We made the decision to fly a conservative profile in and around the airfield as part of Tactical Horizon Extension 1—the detailed timeline (Appendix 4) would be sacrificed in order to focus on the major muscle movements of transferring control and manipulating the camera through our respective SA systems. The objective area became a resolution target painted on the departure end of Runway 28: the Pelican would be in an orbit overhead the airfield, and the ground team would take up a position at the approach end of Runway 28. We and our equipment were ready...so we thought.

C. TACTICAL HORIZON EXTENSION 1, TUESDAY 15 AUGUST 2006

As with the previous mornings, the fog was thick and delayed flying activities for about 2 ½ hours. Once again the time was used to check and recheck all of the systems and configurations (Figure 17). One change from the night before was to launch the UAS for a short flight and then recover it to assess all of its components as it had not flown in several weeks. Keeping with the sequence of events (not the timeline), the Pelican launched uneventfully at 1037L and began its climb to its orbit altitude of 3500 MSL. The ground team vehicle was established at the approach end of Runway 28 and kept radio contact with the Pelican (Figure 18).¹⁹ The GCS van spent the next 30 minutes establishing itself next to the runway (it had to be moved 200ft from the runway for

¹⁸ Rascal 281 would be repaired by Monday as a back-up for the scheduled test flights, but Dr. Vladimir Dobrokhodov was called away unexpectedly, leading to the cancellation of Monday's test flights.

¹⁹ Even though everyone was within line of sight radio range, to exercise the communications links that would be required on Thursday, it was decided to keep the communication plan the same.

Pelican take-offs and landings) and preparing Rascal 293 for takeoff. Rascal departed for its short “warm-up” flight and landed uneventfully seven minutes later. Airframe and payload inspection yielded no concerns so the aircraft was immediately re-launched at which point it climbed under manual control and was passed off to the Piccolo controller. An orbit was established over the airfield by Rascal at 1,000ft AGL and in Figure 19 the two aircraft can be seen in what appears to be close formation, but are actually separated by 1500ft.



Figure 17. Tactical Horizon Extension 1—Pelican

**Tactical Horizon Extension 1—Ground Team
15 Aug 2006**



Figure 18. Tactical Horizon Extension 1—Ground Team

**Tactical Horizon Extension 1
15 Aug 2006**

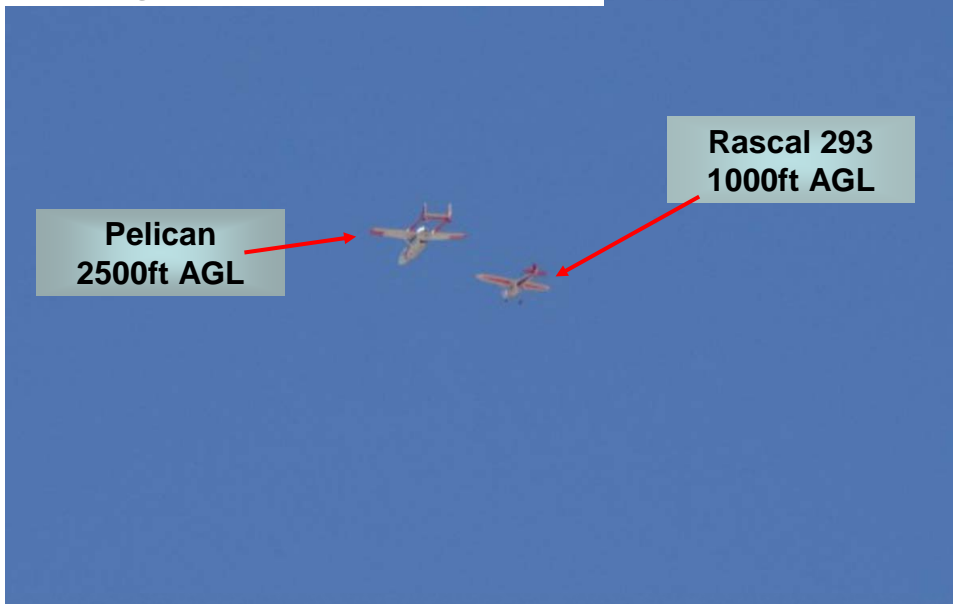

Figure 19. Rascal and Pelican in Flight

1. Transfer of Rascal Control to Pelican

Positive control of the aircraft was transferred to the Pelican from the GCS (a first according to our research of network control in a manned aircraft—others have demonstrated full GCS control from manned aircraft) where Major Glass input a waypoint approximately 2.5km north of the airfield with the intent of reducing the time compression of having everything happening right on top of the airfield. He would then turn the Rascal around and bring it back to the resolution target. Rascal acted as expected and was visually seen turning toward the north and tracking straight and level until it could no longer be seen. Shortly thereafter the ground team received a call from Pelican that they had lost their video signal, at which point all stations confirmed the loss of video input. Not coincidentally, the GCS, Pelican and ground team were no longer receiving GPS position updates and Rascal 293 no longer was shown as a node in the mesh architecture or was broadcasting telemetry over the 900MHz link. Periodically a network link would be re-established with the aircraft but it would be lost before any commands could be given for the aircraft to return to the airfield. Dr. Dave Netzer, Dr. Kevin Jones (with a transponder DF antenna) and the ground team departed for the coordinates of the last GPS telemetry coordinates sent by the Piccolo autopilot. The remainder of the crew at the airfield continued to get sporadic connectivity with the UAS but connections were lost as quickly as they were acquired.

A hand-held GPS, the transponder antenna, and a good pair of binoculars located a relatively intact aircraft on the ground approximately 200 meters from the last waypoint entered from Pelican (Figures 20 & 21).

**First Flight Crash Rascal 293
(Engine Failure) 15 Aug 2006**



**Impact Point approx.
2.7km from Runway**

Figure 20. First Flight Crash

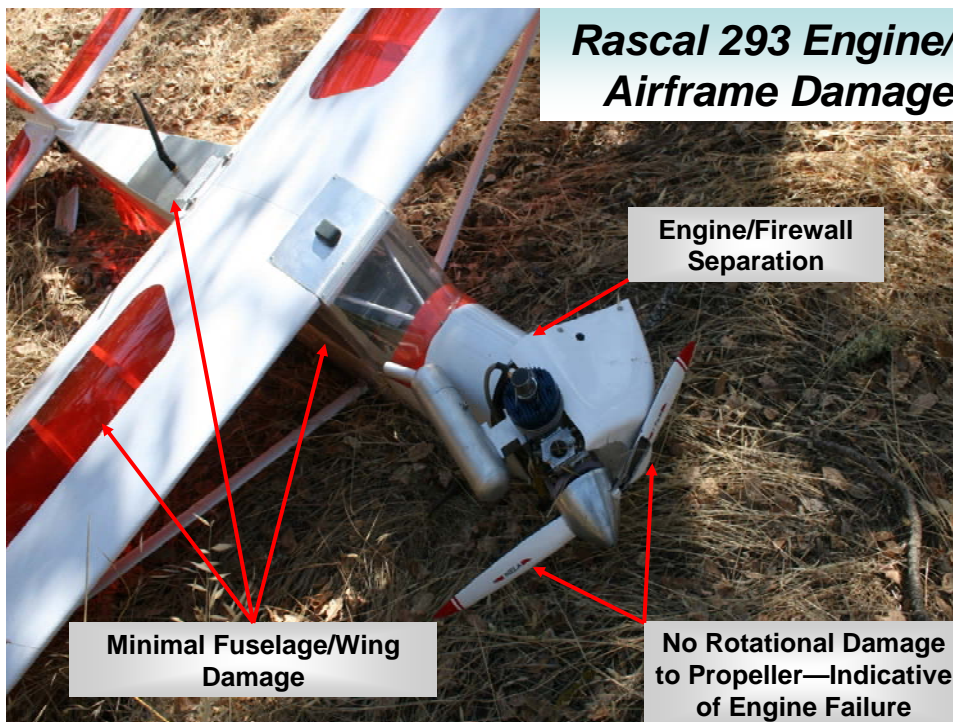

**Rascal 293 Engine/
Airframe Damage**

**Engine/Firewall
Separation**

**Minimal Fuselage/Wing
Damage**

**No Rotational Damage
to Propeller—Indicative
of Engine Failure**

Figure 21. Rascal Damage—Post Crash

Inspection of the area around the aircraft revealed the landing gear approximately 50 meters uphill in a clearing with ground furrows leading to its resting location at the

base of a tree. The aircraft itself showed almost no damage to the wings and fuselage, but the engine/mount and firewall had separated from the cockpit. In fact, the autopilot/GPS and mesh networking payloads were still on and appeared to be operational. The propeller was still intact and showed no signs of rotational damage—indicating it was most likely not turning when the aircraft impacted the ground.

2. Post Crash Analysis

Engine failure was confirmed by analyzing the telemetry data sent back to the Piccolo control station through the 900MHz link. For unknown reason or reasons, the engine quit 1 min. 53 sec. after the Pelican took control and sent it northward towards the waypoint. The autopilot continued to track to the waypoint sacrificing altitude for airspeed and had entered its first orbit when it literally landed on the top of a hill and slid to a stop. Figure 22 graphically depicts the events as described above as extracted from the telemetry data.

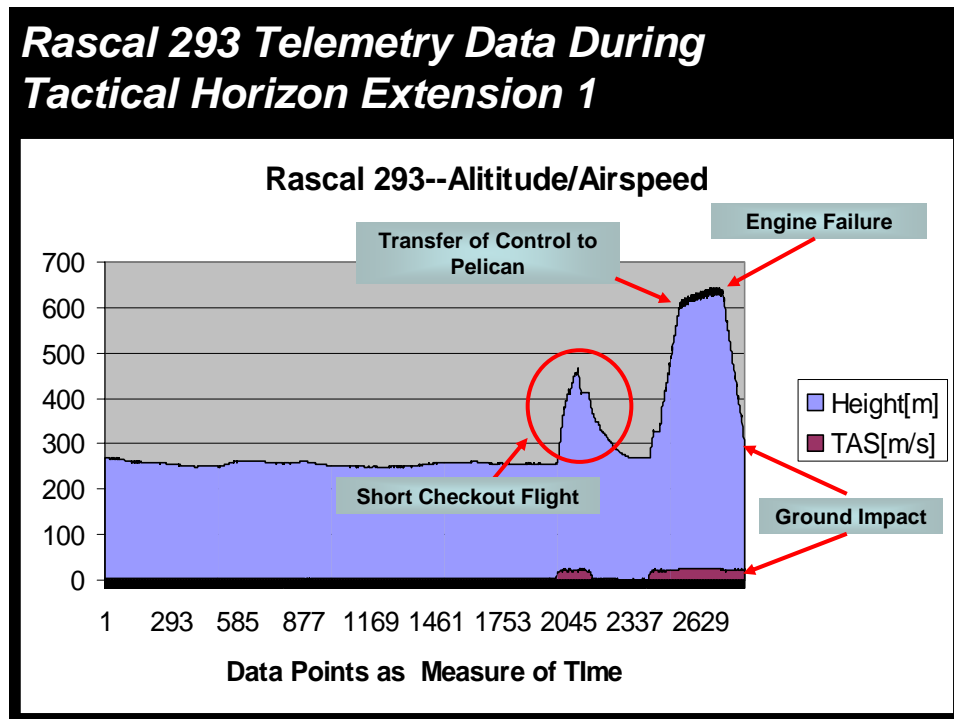

Figure 22. Accident Telemetry

Discussion of the day's events highlighted three critical items. First, we had successfully transferred control of the Rascal UAS to the Pelican. Second, the unique self-forming, self-healing nature of the mesh was proven under the most unique of circumstances. The reason for the intermittent network connectivity even after the

aircraft had crashed was relatively simple: the Rascal network payload remained operational, and every time the Pelican would get within line-of-sight of the UAS, the network connection was re-established, and the GCS and ground party were able to connect to the Rascal through the Pelican. As the Pelican orbit took them BLOS, connectivity was lost until the next orbit. The third item was the need to screen capture each of the computer stations activity for better post-mission analysis.

3. Tactical Horizon Extension 2 Preparation

Fortunately, Rascal 281 had been repaired and fell in to the primary slot for our final opportunity to demonstrate the Tactical Horizon Extension concept. Wednesday, 16 Aug was intentionally programmed as a day for correcting any issues that arose during the first demonstration and in this case, the task of the day was to prepare our spare UAS for Thursday's demonstration. Rascal 281 did not have the same electronic payload as Rascal 293, so the decision was made to swap the entire networking, processing, and video stack from 293 to 281. Due to the earlier crash, once the swap was complete, we ran through a complete set of connectivity checks with each system to ensure system integrity had not been lost in the crash impact or swap between aircraft. Following some software configuration changes, Rascal, Pelican, GCS and ground team stations were operational.

D. TACTICAL HORIZON EXTENSION 2, THURSDAY, 17 AUGUST 2006

Thursday morning again brought fog, but a slight delay was welcome to check-our equipment one final time. We decided not to follow our original timeline and scenario; we would instead exercise all of the major parts of the scenario when and if we became comfortable in our ability to effectively control the Rascal and its payload/camera. We had no doubt in the capability to accomplish the task at hand; our concern lay in what other unknown might be out there which could affect the results.

Shortly after 0900, the Pelican took-off and established its orbit at 2,500ft. AGL above the runway. In the interim, the ground team moved out to the OP, approximately 1,000m from the target, and established communication and network links with the Pelican and GCS (via Pelican) back at the airfield. Video connectivity appeared excellent as all players were able to monitor the preparation of Rascal 281 for take-off through the onboard camera. Rascal was airborne at about 0930 and manually climbed out. Control

was passed to the Piccolo autopilot controller and finally the SA GCS controller established a 1,000ft AGL orbit over the airfield. After a thorough check out of the network and autopilot interfaces, the Pelican took control of the aircraft and established new waypoints in and around the airfield. Progress was slow but positive, except for control over the camera. The default mode for the camera is to look at the coordinates of the waypoint which is active within the autopilot. It was unclear what geo-spatial point the camera was looking at, but the decision was made to press on with the profile and troubleshoot the problem in flight.

Pelican was finally given clearance to take Rascal 281 all the way to the target area in an attempt to find and orbit the painted 8x8ft. structure. Unfortunately, the camera problems continued, and few if any recognizable features could be seen on the video. The ground team could visually see the UAS in an orbit that approximated the area around the target, but also could not correlate what was being seen on the video. Manual control of the camera was attempted, but with no known visible ground references, the target could not be found. After 15 minutes in the target area, UAS control was passed to the ground team who spent another 10 fruitless minutes trying to locate the target by manually manipulating the camera with no success. Successful transfer of control back to the Pelican and on to the GCS for an uneventful landing brought to a close Tactical Horizon Extension 2.

1. Post Mission Analysis

Overall, the mission was a success in that effective UAS control was passed between all players and video images (of what we are unsure) were received through the same network. Dr. Dave Netzer pushed for the team to find a solution to the video control problems and re-accomplish the mission in 2 hours. There is no doubt, that

completing the profile as originally planned would be a much better story, so the technical team²⁰ went to work in order to iron out the video control bugs. After lengthy ground testing, it was discovered that the default altitude for the target in SA was set to 490 meters by looking at the UAS control message and the SA camera control panel (Figure 23). The result of the default setting is the camera would be looking at a point nearly 700feet above the target (almost level with the aircraft). Thus, the look angle of the camera would appear to be out on the horizon. Once the fix was identified and the changes verified through SA (Figure 24), preliminary tests were conducted to re-accomplish Tactical Horizon Extension 2.

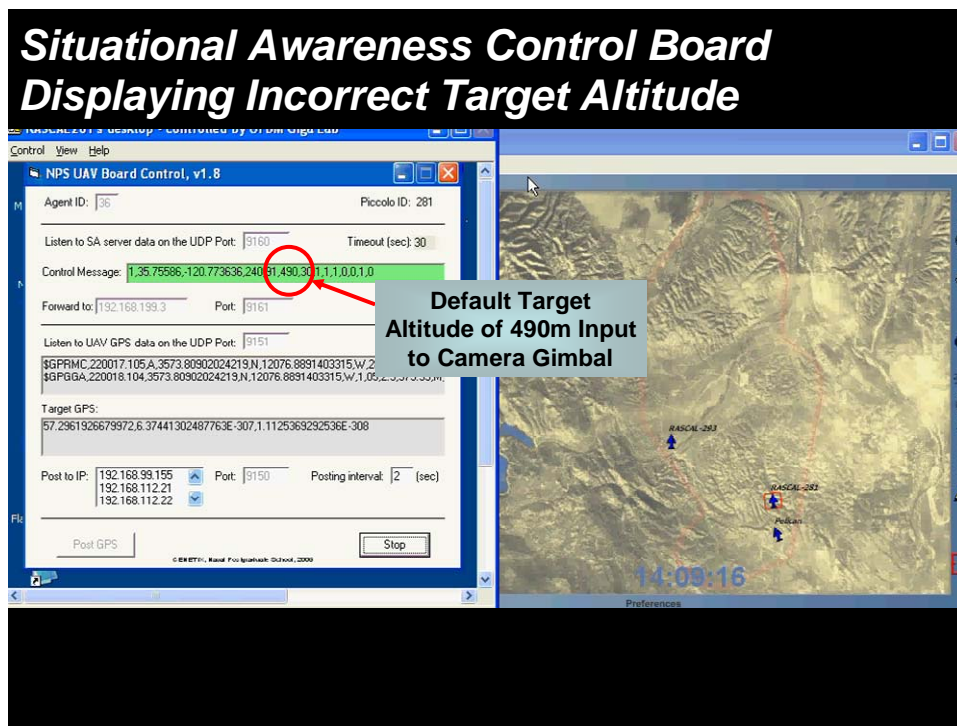

Figure 23. Incorrect Target Altitude in SA

²⁰ The technical team consisted of Eugene Bourakov, Dr. Kevin Jones, and Dr. Vladimir Dobrokhodov.

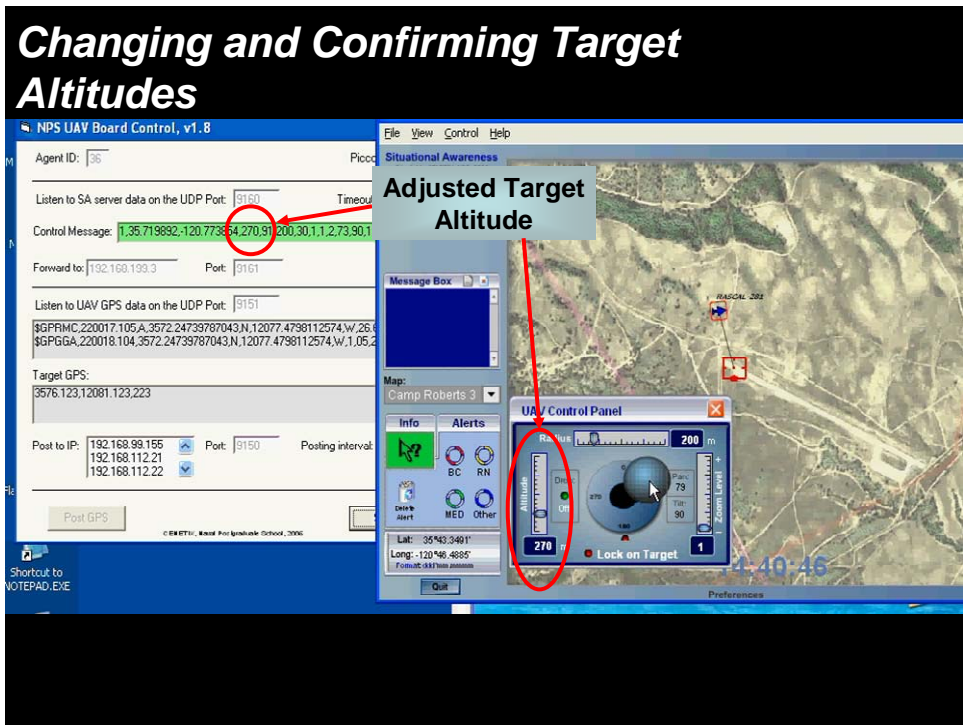

Figure 24. Correcting Target Altitude

E. TACTICAL HORIZON EXTENSION 2A, AFTERNOON OF 17 AUGUST 2006

Launch of the Pelican and movement of the ground team to the OP were uneventful. Good communications, network and video were established and all players were able to watch the launch of Rascal 281 through a live video feed (Figure 25).

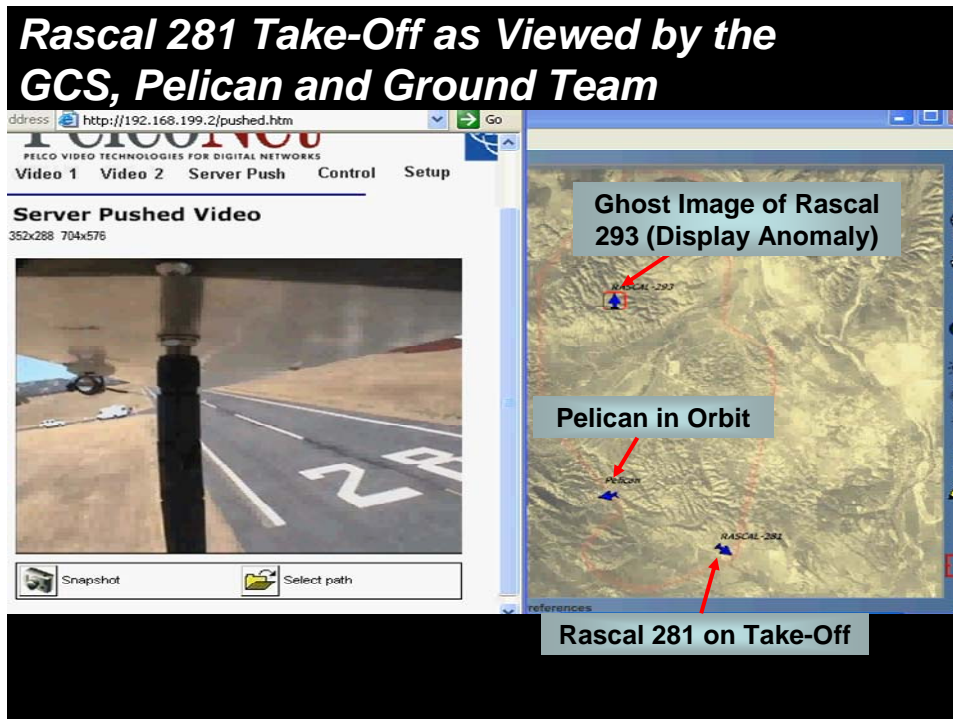

Figure 25. Tactical Horizon Extension 2A Take-Off

Transfer of manual control to Piccolo and on to SA GCS control happened rapidly, and the Pelican was cleared to take control and send Rascal 281 to the target area. The Piccolo control station verified the flight of Rascal along Canyon Road enroute to the target, and with the change of the target altitude in SA by Pelican, the camera was tracking along the same road (Figures 26 &27).

Piccolo Telemetry and Control Station View of Canyon Road



Figure 26. Canyon Road from Piccolo

Canyon Road Approach to Target as Viewed by Pelican from Rascal



Figure 27. Canyon Road from Rascal

1. Pelican in Control—Finds Target

To this point, the network, camera and video were all working well but the true test of the system was our ability to find the target. Positive identification was made of the target by Pelican, GCS and the ground team as they viewed the video shown in Figure 28. Rascal 281 established its orbit as programmed and Pelican began manipulating the camera to better define the target and the surrounding area (Figure 29).

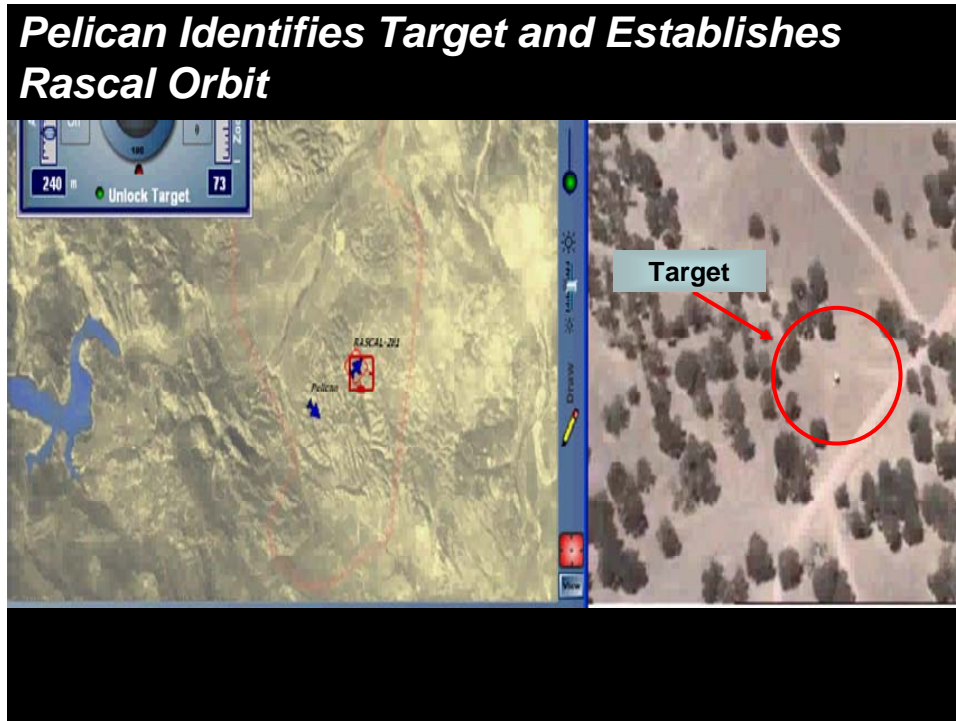

Figure 28. Pelican Identifies Target

Pelican Zooms Camera to 73% for Better Resolution

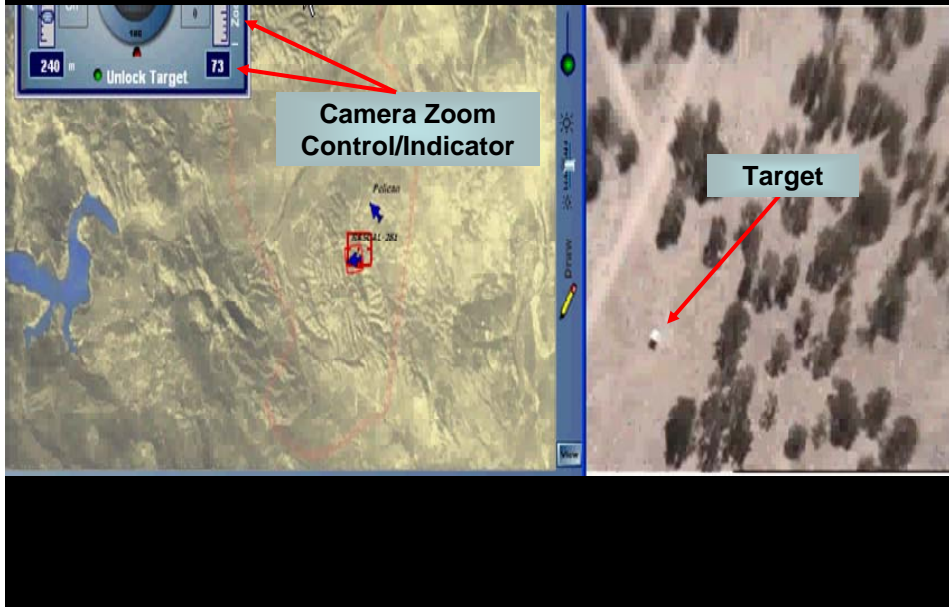

Figure 29. Zooming in on Target

It is at this point that Pelican had a difficult time manipulating the camera, in an attempt to keep the target in view. A small amount of latency within the camera control/video transmission system made fine adjustments difficult, if not impossible.²¹ After several more minutes the Pelican sent Rascal 281 to a waypoint near the ground team OP where the planned transfer of control took place (Figure 30). The intentional pulling of the Rascal off the target, at this point, might appear to be tempting fate; but it was important to the demonstration to show how the ground team could independently acquire the target and develop it as though the target had not been previously viewed by any other source.

²¹ It is important to note that the screen captures seen throughout the document were taken at significantly reduced image qualities and thus only represent a fraction of the image quality seen during the actual demonstration.

Pelican Hand-Off to Ground Team



Figure 30. Pelican Transfer of Control to Ground Team

2. Ground Team in Control

The ground team immediately established a new waypoint in the vicinity of the target and visually confirmed the target as seen in Figure 31. The same images were being seen BLOS by the GCS via the mesh, automatically creating a network connection to Rascal 281 through the Pelican (Figure 32). Pelican maintained good quality video and situational awareness throughout the ground team reconnaissance (Figure 33).

Ground Team Control—Orbit Established



Figure 31. Ground Team Control—Orbit of Target

GCS Real Time View of Ground Team Target Capture Through Pelican

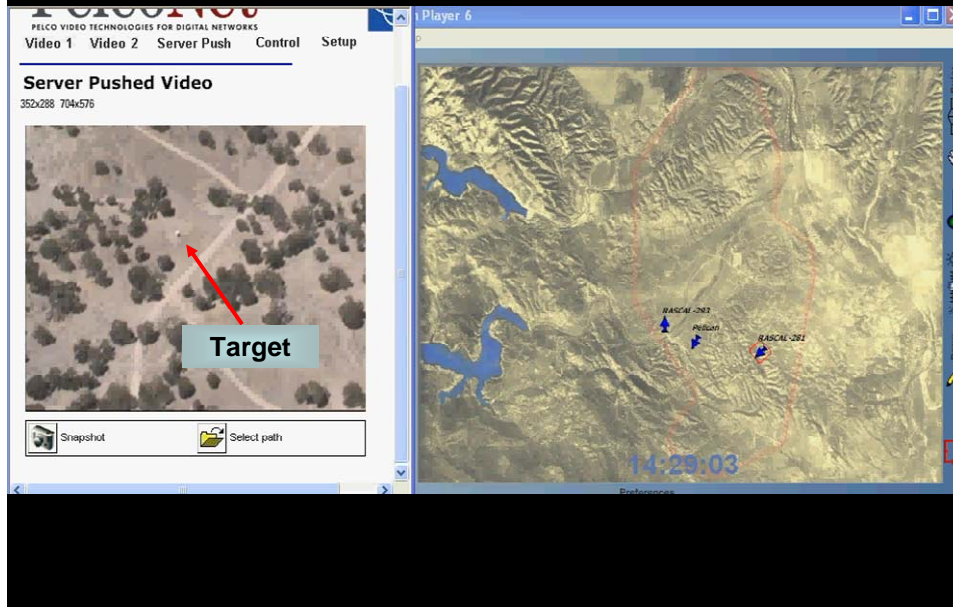

Figure 32. GCS Real-Time View of Ground Team Control and Video

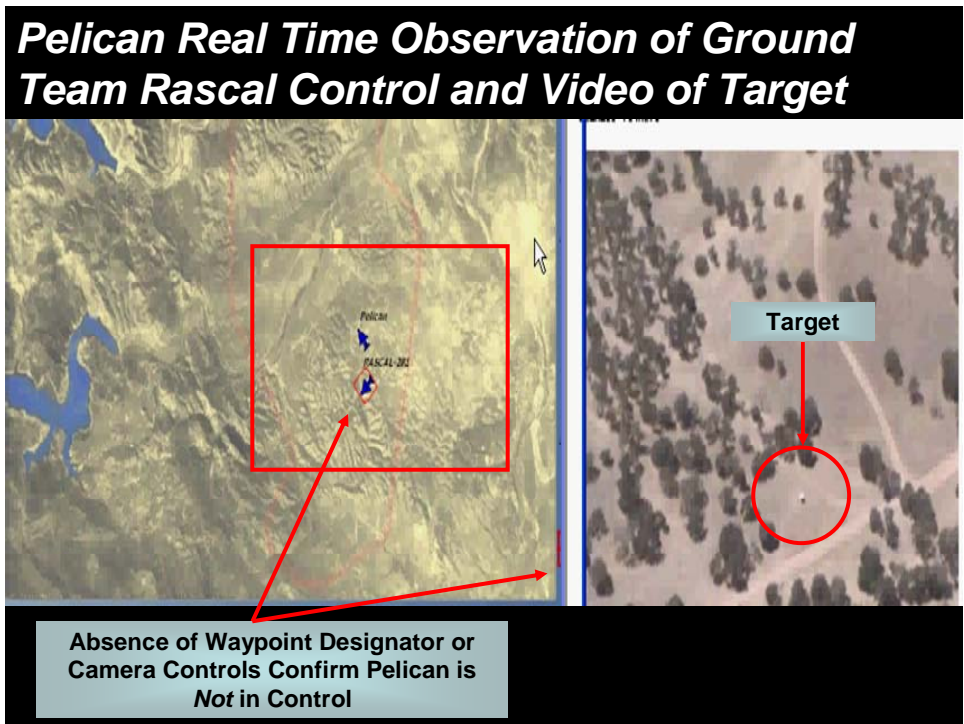

Figure 33. Pelican Real-Time View of Ground Team Control and Video

During the Pelican and Ground Team control of Rascal 281, GCS controllers were constantly measuring the distances between Rascal, Pelican, ground team and the control van to get a rough idea of how strong mesh connectivity was from air-to-air and ground-to-air (Figure 34). Fortunately, network performance was not an identifiable limitation during any part of the demonstration.

Evaluating Mesh Distances from GCS

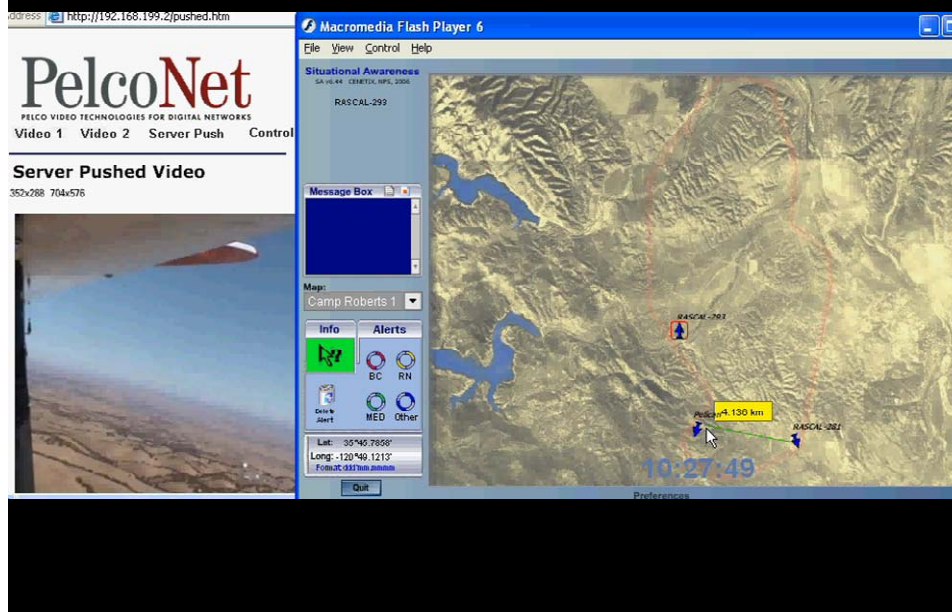

Figure 34. Evaluating Mesh Distances

3. Bringing Rascal Home

After collecting sufficient information on the target and surrounding area, the ground team established a new waypoint in preparation for hand-off of control back to Pelican (Figure 35). Pelican re-assumed control of Rascal 281 (Figure 36) and sent it back to the airfield where manual control was once again used for an uneventful landing and demonstration completion.

Making a New Waypoint (Preparation for Transfer of Control Back to Pelican)

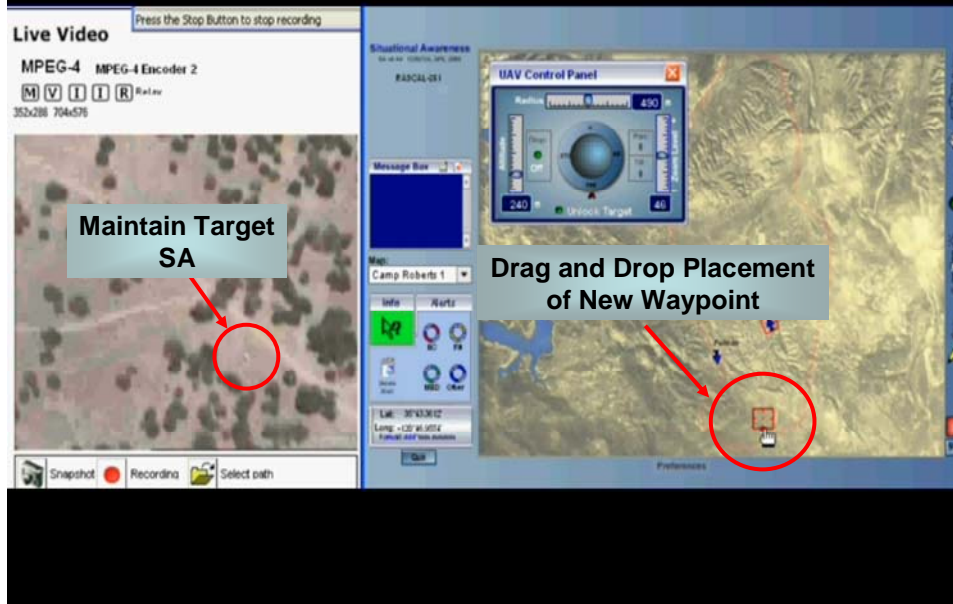

Figure 35. Ground Team—Making a New Waypoint

Transfer of Rascal Control from Ground Team Back to Pelican

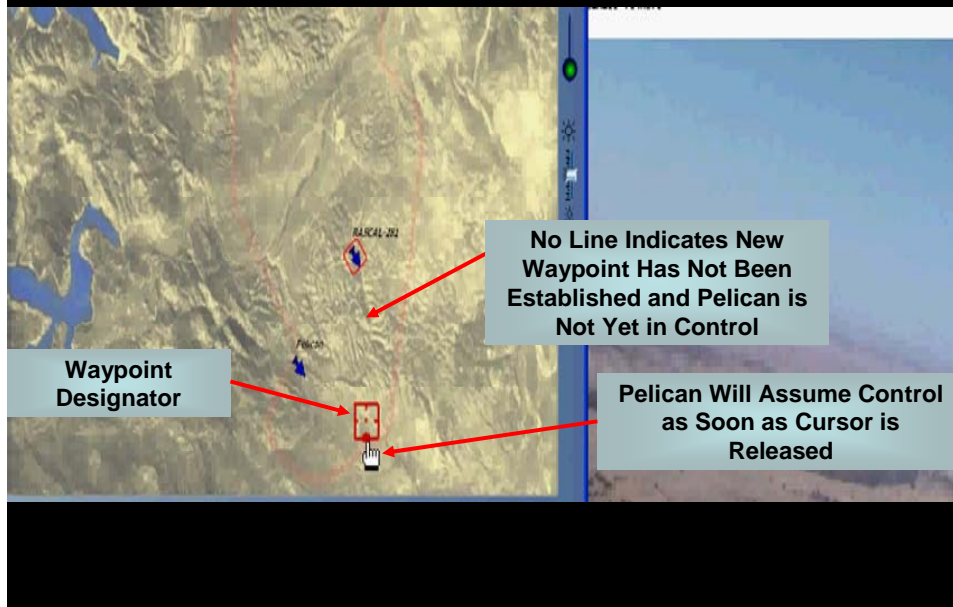

Figure 36. Transfer of Control from Ground Team to Pelican

THIS PAGE INTENTIONALLY LEFT BLANK

IV. RESULTS/FINDINGS

The results of this experiment exceeded expectations. In executing our published schedule of events, the research team overcame several obstacles to meet every objective and gathered useful data on every measure of performance which we established for ourselves. In the paragraphs below we will examine each objective and measure of performance in detail.

A. OBJECTIVES

- 1. Establish Effective UAS Control via Mesh network (airframe and camera) from Airborne and Remote Ground Stations: Also, add UAS waypoints and change flight parameters as well as manipulate on-board camera for target reconnaissance**

During the first flight on Tuesday, 15 August, we successfully met only part of this objective. The UAS engine failure led to a premature conclusion of the day's work, and while we were unable to thoroughly evaluate the camera or execute a handoff to the remote ground party, the airborne node, Pelican, was able to take control of the UAS and send it to a new waypoint. Also, the ensuing search and recovery effort revealed a more robust and reliable mesh network than we anticipated. On the first flight of 17 August, we met all but the last sub-objective due to the altitude at which the camera searched for its target. That afternoon we remedied that and successfully met this objective in its entirety.

- 2. Evaluate Video Quality to Determine Aircraft and Sensor Capabilities**

As the figures in the previous section show, the camera on the NPS UAS was able to find a target with known coordinates. In manipulating the camera, however, both the Pelican operator and forward ground operator experienced difficulty in keeping the target in frame with any significant zoom on the camera. This is due to the small size of the UAS in somewhat bumpy atmospheric conditions as well as the camera being hard-mounted to the fuselage and not gyro-stabilized. For this reason we determined that, while one could find a target area with this camera, one could probably not exploit that target with any significant fidelity. That is to say, we could locate a house but not positively identify a particular person entering or leaving that house. There are several reasonably low-cost, small gyro-stabilized cameras available which could eliminate this

limitation. Because the Rascal UAS is simply a test-bed platform used to facilitate a wide variety of network and communications experiments, it is not necessary to install such a sensor solely for this project. The current equipment configuration is adequate for near-future research in the Tactical Horizon Extension project.

3. Use the Mesh Network to Supply Real-Time Video to Pelican, Ground Team and TOC for Simulated ISR Target Development

We met this objective with limited success. Due to the bandwidth limitations discussed earlier, three users attempting to view FMV over this network degrade the quality of the video to unusable. After discovering this, however, we established an informal schedule by which only the primary operator at any given time would select FMV while the other two would view the imagery in server push mode. This saved enough bandwidth to give the primary operator high quality video (required for manipulating the camera) while other nodes received a new frame every few seconds and were at least able to see what the primary operator was doing.

4. Manipulate Mesh Nodes to Simulate BLOS Between Parties

Central to our research concept is the autonomy of the forward tactical network. There were practical concerns in this experiment, however, which limited our ability to truly test this. The primary concern was preserving the UAS. Because the SA control interface does not transmit engine health information or aircraft telemetry, the research team was concerned about crashing another UAS (our last one, at the time) by not recognizing an impending system or engine failure. We agreed then that we would design the experiment such that the UAS would always be within LOS of the GCS for the 900MHZ autopilot and, if required, the GCS could intervene, take control of the UAS and return it to the airfield. In order to test the autonomy of the forward tactical network then, we simply arranged for the GCS to shut down their mesh node for a short period of time. During this interval the nearly autonomous forward tactical network performed as advertised with both the airborne and remote ground nodes able to task the aircraft, manipulate the camera, and exploit the video.

B. MEASURES OF PERFORMANCE/ MEASURES OF EVALUATION

1. Safely Transfer UAS and Camera Control Between GCS, Pelican and Remote Ground Team

All transfers, or handoffs, between the various nodes were successful and uneventful. Each handoff was, however, verbally coordinated to avoid confusion. The SA software has no priority protocol which would allow a certain node to control the aircraft over another node. Nobody really knew what would happen if two nodes simultaneously attempted to control the UAS. After the mishaps on Saturday and Tuesday, the research team unanimously decided that we did not really want to explore this aspect of the SA during the present evolution. We did not, therefore, attempt uncoordinated transfers of control. While this is not important in the context of the Camp Roberts experiments, the added burden of voice communications in combat conditions could add an unnecessary level of vulnerability to this network concept. Future research should attempt to streamline communications and eliminate the need for network nodes to have voice communications.

2. Evaluate Image Quality for Target Development and UAS/Sensor Control

As discussed in the Objective section above, the image quality and platform/sensor functions were marginal. Additionally, the sensor control portion of the SA program is not as user-friendly as it could be. The flat display and the in-keyboard mouse on the Panasonic Toughbook laptops made camera manipulation somewhat difficult. The addition of a joystick would allow for easier, more intuitive control of the camera. The difficulties in positioning the camera were compounded by latency in the video link. This led to several instances in which the operator attempted to increase the camera's zoom while the target was no longer in the center of the frame, causing him to lose the target completely. The latency issue stems from bandwidth limitations and multiple users on the Pelco server. We currently have no solution for this within the ITT Mesh network system.

3. Functionality of Hardware and Software for Future Development and Field Application

As stated previously, the UAS, network, and sensor we used in this experiment were chosen not for their idyllic properties or direct application in the field. We used these components and software programs because they were available to us and were sufficient to test the concept. For the purpose of future experiments at NPS, the current composition of the network and node components are still good enough to further explore this concept; for example, adding another UAS to the network. Field application of this concept will require significant changes. We will discuss this in depth in the next chapter.

V. CONCLUSIONS

A. OBSTACLES AHEAD

The Naval Postgraduate School Tactical Horizon Extension Project is a concept in its infancy. As stated in the introduction, we set out to find a method by which special operators could obtain persistent, over-the-horizon ISR capability without tasking LDHD assets or requiring an exorbitant budget. The concept elucidated in this paper offers a way for USSOCOM to develop this capability. But future research must address several technical questions before this concept will bear fruit for operators in the field. The primary questions are: What technology should form the network? What is the best platform for the concept? And what sensor(s) should that platform carry?

1. The Network

As stated earlier, we utilized an amplified ITT Mesh network because the NPS Research effort was configured for this format as a consequence of other projects. The ITT Mesh has the advantages of being self-forming and self-healing with full connectivity between nodes. We think these qualities lend the technology to forward, dispersed operations. But this capability comes at the cost of range. The entire scenario described here was executed within 5 kilometers of the UAS departure airfield. To be useful to soldiers in the field, the range between nodes must increase. Network connections utilizing directional 802.16 or 802.20 technology have much better range, but cannot provide full connectivity between nodes and inevitably establish at least one node as a single point of failure for the entire network.

Another problem, perennial in mobile networks, is bandwidth. This is most clearly illustrated by the limited FMV output shown in our experiment. As it stands, each node that downloads the Pelco video reduces the network's available bandwidth proportionally. That is to say, when a second user initiates the Pelco application, the bandwidth available to the network is cut in half. The third user reduces this to one third of the original capacity, and so on. The effect of this is immediately apparent as the video fidelity and update rate degrade for all nodes, eventually to uselessness.

In addition to the bandwidth issue, the ITT Mesh network is fragile and prone to interruption by competing frequency use as well as antenna pointing and masking problems. In our experiment evolution, we mitigated these limitations by artificially sterilizing the environment. As is customary in the TNT experiment process, we eliminated frequency competition from other experiments through a rigidly controlled emission schedule. It is of course unreasonable to expect such a level of control in actual field conditions. Recognizing our abbreviated preparatory phase and ensuing aircraft mishaps, we found ourselves unable to fully test antennas of varying strength and impedance. We elected to use low-impedance, omni-directional antennas for all nodes. These low-cost antennas yielded excellent connectivity throughout all of the flight parameters for both the UAS and airborne node, again with a range penalty. Application of this concept in the field must reconcile these technical limitations.

2. The Platform and Sensor

The successful employment of this concept depends upon finding an airframe with sufficient power, endurance, and payload to provide a remote team with viable FMV for an extended period while being launched from a rear area. There are a few such systems in production or development. This research team favors Boeing's Scan Eagle for several reasons. First, the aircraft advertises a 15-hour flight time with a 68-knot cruising speed. This would allow commanders in the field a significant level of flexibility in choosing areas to deploy the asset as well as targets to develop. Second, the engine is sufficiently powerful to fly above 16,000 feet MSL.²² This provides standoff from small arms, a reduced noise signature, and operations in mountainous terrain. Third, the aircraft does not require a runway for launch or recovery. This adds even more flexibility in deciding where to deploy the asset.

The Scan Eagles in use today are equipped with an inertially-stabilized camera or Infra-red sensor capable of providing FMV. The transmission technology is different, but could be altered through research efforts including the USSOCOM-NPS Field Experimentation Program, which already possesses a Scan Eagle.

²² Scan Eagle information accessed from http://www.spacewar.com/reports/Boeing_ScanEagle_UAV_Surpasses_10000_Combat_Flight_Hours.html (27 Aug 2006).

B. THE WAY FORWARD: TECHNOLOGY AND DOCTRINE

At one of the first planning meetings in preparation for this project, Dr. Alex Bordetsky, an Associate Professor in the Department of Information Sciences, said something very important with respect to the development of this concept. When asked what sort of network could be established to facilitate the experiment, he answered that the correct question is not what can we put into a network—meaning bandwidth, power, etc; but what is *appropriate* for a particular network connection. In other words, the forward tactical network should be comprised of technology and capability commensurate with its intended use. The concept of employment, or doctrine, is therefore as important as technology in addressing the issues of connectivity, bandwidth, fidelity, and range in realizing this concept.

If one applies this idea to the whole project, one sees the way forward is a combination of these two concepts: technology and doctrine. There are technical solutions for all of the issues listed above, eventually. We can potentially increase mesh network range by amplifying the signal to five or even ten watts by simply purchasing the amplifiers for the next TNT evolution. We can increase available bandwidth by developing a more robust, expensive network and by incorporating on-board video processing and utilizing end-state enhancements such as VICE or TIPS. Someday, we may have a tactical UAS capable of flying for 36 hours and providing both IMINT and SIGINT. Eventually, we could provide a long-range reach back capability that would allow CONUS-based commanders to view the FMV and decide on a course of action.

In addition to the technical effort, however, each of these issues has a corresponding solution in the doctrine which dictates the application of the concept. For example, if the forward ground team is autonomous and empowered to formulate and act upon a course of action against a given target, range issues for the purpose of reach back become less problematic. Similarly, if one can limit the number of people authorized or required to view FMV to the forward operator and commander (and not superfluous personnel in the TOC), the bandwidth issue becomes less urgent. Also, through judicious selection of deployment locations, commanders can optimize the coverage of a given platform. This could mitigate range and endurance requirements for the UAS. Furthermore, in formulating a concept for operations, special operators would take into

account the urgency of the fight with the utility of the concept, and therefore weigh the value of a given technical capability against the resources required to develop it.

A coherent concept for employment, in advance of a full-blown, funded research and development program would therefore serve two purposes in this case. First, it would eliminate technical research efforts aimed at developing unneeded capability. Second, it would balance the need for a stated requirement against the time and money needed to fulfill that requirement. On the whole, then, a solid concept of employment for this capability will make any development effort more cost-effective and put the capability in the field sooner.

C. SUGGESTIONS FOR FURTHER RESEARCH

Gaining approval for a research and development program and developing a concept of operations for this idea are well outside the scope of this paper and the expertise of its authors. But as stated above, this project is in its infancy and there are several possibilities for further research that are within the existing NPS research program and budget.

1. Develop Options for ITT Mesh Networks: Antennas and Amplification

Because of the problems establishing the network and a compressed preparatory stage of our experiments, we were unable to fully exploit different possibilities for optimizing the range between mesh nodes. Future researchers should experiment with various antenna configurations to quantify an optimal arrangement for all of the nodes in the forward tactical network. Options include, higher-impedance, directional patch antennas and medium-impedance, omni-directional antennas.

NPS should attempt to obtain an FCC waiver for higher output in the 2.4 GHz range. Five or even ten watts could possibly extend the maximum range of the network to approximately six and eight nautical miles respectively. But this may be problematic if the network is not stable. The amplifier then amplifies noise as well as data. Only further experimentation can answer these questions.

2. Alter the SA Program to Allow a Single Node to Control Multiple UAS's

We envision a fully integrated network in which a remote ground team could use multiple UAS's to develop a target utilizing both IMINT and SIGINT. This would allow

for cross-queuing between the platforms for enhanced exploitation. Developing a test bed capability for controlling multiple NPS UAS's through the existing SA program will enable future researchers to execute much more advanced scenarios to further explore the utility and viability of this concept.

3. Incorporate the Scan Eagle in Future Experiment Scenarios

NPS researchers should configure the Scan Eagle for mesh-enabled control and use that platform for future experiment scenarios. In accomplishing this, researchers will answer several questions concerning the viability of the Tactical Horizon Extension Project in the field. For example, can the SA program be altered to not only control different UAS's, but also different cameras or sensors? Will the realization of the horizon extension concept require some follow-on version of SA, or something completely new? How well will the mesh network adapt to different or dissimilar platforms? Can the range enhancements discussed in the previous section keep pace with a UAS that flies above 10,000 feet? If not, what alternatives to mesh are available? By addressing these questions through the USSOCOM-NPS Cooperative Field Experimentation Program, NPS will do the bulk of the work required to ascertain the combat viability of the Tactical Horizon Extension Project. USSOCOM can then decide if the idea merits further development.

D. FINAL THOUGHTS

We emphasize, once again, this is a rough concept. We began our research with the broad aspiration to contribute something to the special operations community that could be useful in the field and available in the near future. After a series of interviews with operators, commanders, and acquisitions personnel at SOCOM, AFSOC, and JSOC, we conceived the Tactical Horizon Extension Project. Because of our unfamiliarity with technical research and NPS research programs, our progress was sporadic and slow. After TNT 06-04, however, we think this concept is sound and deserves further development as quickly as the USSOCOM-NPS Cooperative Field Experimentation Program allows.

There is real potential for this concept to yield an effective means by which special operators can significantly increase their ISR capability through a low-cost, *organic* system of networked UAS platforms. Such a network requires no UAS pilot

training for SOF personnel, just familiarity with whatever mechanism eventually controls the sensor. For the most part, the technology exists today and would not add weight to the soldier's rucksack. If SOCOM has any interest in this concept, the J3 section should present it to operators as soon as practical and begin to formulate a concept of employment with which to guide further research and development. We hope future research will succeed in making this concept operational and contribute to field operations in the near future.

APPENDIX A. EXPERIMENT 1 TEST PLAN

Experiment #1: Multiple handoffs of a UAV between ground and air control elements

Technology. (Marina airfield) Using the GCS (van) and NPS UAS (power-on) on the ground (preferably suspended), transfer control from Manual (simulated Don launching) to Piccolo (Vlad in the van) to a third operator (Kent in vehicle) with SA-equipped laptop and antenna (ITT amplified mesh). Monitor UAS for flight control response and sensor movement.

Attempt further handoff to Pelican with SA-equipped laptop and antennae (amplified mesh). Try several antennae from the aircraft if possible and establish basic range limit by concentric, expanding orbit around stationary UAV. Repeat the handoff sequence several times to gain confidence and reveal any glitches in the handoff process.

If possible, accomplish this at a model-aircraft approved flight area. Therefore, if the above actions are successful, we can attempt the same handoff scenarios with an airborne UAV.

If confidence in the process allows, Pelican will attempt to ferry the UAV outside the control range of the van, then ferry the UAV back to the van or other ground control element.

All users must maintain voice comms to minimize confusion and allow for quick resumption of control by the van, or Don.

MOP's:

1. Continuity and quality of the mesh network in terms of controlling the aircraft and streaming video from the aircraft to the other users.
2. Seamlessness of the handoff process. Can different users hand the UAV directly or should they relinquish control to the internal autopilot and then allow another user to assume control?

Responsibilities:

Van	Kevin Jones, Vlad Dobrokhodov
Manual controller	Don Meeks
Ground-mobile SA Controller	Kent Landreth/ Eugene Bourakov
Pelican controller	John Glass

THIS PAGE INTENTIONALLY LEFT BLANK

APPENDIX B. 31 JULY, 2006 FLIGHT TEST SUMMARY

NPS UAS to Pelican Data Link Over Mesh Network

Date: 31 July 2006

Setup: Airborne test of Pelican control of NPS UAS sensor.

IT Amplified Mesh (2.4GHz, 1 watt) network at 3 nodes: Pelican, UAS (Rascal 2), and Ground Party (LRV). Single SA server was on the LRV which was parked beside a stepladder on which the UAS was mounted. The Pelican mesh antenna was mounted to the aft extension located at station 8.

Took off at 1550 (L) and brought up SA immediately--achieved a solid link. Pelican established 2nm arc at 900-1000ft AGL. Pelican node showed excellent video quality in Video 1 (500 m/s). Operator was able to manipulate the UAS camera in pan and zoom with only a short delay (1-2 seconds). Climbed to 1200-1400ft AGL and saw no degradation. Accomplished 2 360-degree turns at 45 degrees of bank at 2.0-2.5 nm and saw no masking of the antenna as the video feed remained strong.

Expanded arc to 2.5nm at 2000ft AGL and began to see some degradation in Video 1. Display would freeze momentarily every 1-3 minutes. In each case, the live feed re-established itself after a momentary delay (1-5 seconds).

At 2.7-3.0nm Video 2 is more reliable with excellent image quality and only occasional drop-outs, all of which resolved in a few seconds.

At 3.1-3.4 nm, Video 2 begins to degrade as drop-outs become more frequent (every 1-2 minutes) and of longer duration (8-10 seconds)

3.7-3.9 nm, the network connection is broken, but was quickly re-established upon closing the distance to 3.0nm.

At 2.5 nm with 45deg of bank there was no loss of video display or control.

Should've tried: climbing in the 2.0-2.5 nm arc to establish a useful ceiling (Netzer's suggestion). Just guessing that with a 3+ nm useful range, at 2nm the useful ceiling would exceed 5000ft above the UAS. Also, should've driven a vehicle slowly down the taxiway to test operator ability to follow an object with the sensor—I mostly just looked at the ground support party to evaluate the video quality.

Conclusions: It appears that this network would be reliable up to 3-3.4 nm. This would accommodate our scenario design and allow for a concept demonstration. But both ground and air (pelican) nodes need an SA server. By having only one SA server in the network we allow a single point of failure to a network whose only real advantage is self-forming, self-healing. Every node that expects to control the UAS should be equipped

with an SA server. Voice links can facilitate handing control of the UAS between SA server-equipped nodes.

APPENDIX C. EXPERIMENT 2 TEST PLAN

Experiment #2: Utilize Networked UAV to Find and Fix a Target

Camp Roberts.

The research team will identify/supply a target in the CR complex—probably north of McMillan airfield along Canyon Road. The target may be an existing structure, a vehicle placed at an intersection, or some other suitable and expedient object(s).

Major Landreth will “deploy” to the OP IVO the objective and establish text communication thru Nacimiento Hill confirming readiness to receive the UAS. Major Glass will launch the Pelican

Prior to UAS launch, conductivity and control tests will be conducted with the Pelican NPS UAS, GCU, and ground party. The ground team will depart the compound and take up an observation post (OP) position near the target but without line of sight, i.e. one ravine away. The designated OP for the ground party will provide similar tactical advantages as an actual OP, but will keep LOS with Nacimiento Hill for simulated SATCOM conductivity with the TOC (OP location will be established along with objective location).

Pelican will depart McMillan airfield and establish an orbit overhead, observing airspace restrictions.

The launch and recovery team will launch NPS-1 and hand it off to the Pelican. Pelican will ferry the UAV to the ground team and handoff control when requested. The ground team will find the target, fix its coordinates if able, and set up an orbit to allow for surveillance and target development. (If time allows, we could have a target vehicle drive down Canyon Rd. (slowly) to evaluate the sensor and platform against a moving target).

The ground team will then hand control back to the Pelican to ferry the UAV back to the launch and recovery team. If the target is mobile, the Pelican controller will attempt to follow the target as long as time and fuel allow.

The Pelican will hand the UAV back to the launch and recovery team for landing.

All teams recover to TOC for hot wash/debrief.

All users must maintain voice comms (through the TOC for the Pelican) in order to facilitate quick recovery of the UAV if needed.

MOP's:

1. Continuity of the Mesh network in terms of seamless handoff of the UAV and text messaging between users to coordinate those handoffs.
2. Ability of the network to supply streaming video to ground team and airborne team.
3. Continuity of the air-to-air link. As the Pelican orbits the UAV during ferry and target portion, when will wing-masking affect the ability of the Pelican controller to pilot the UAV?

Responsibilities

Van	Kevin Jones, Vlad Dobrokhodov
Manual controller	Don
Ground-mobile SA Controller	Kent Landreth/ Eugene Bourakov
Pelican controller	John Glass
Target driver (if required)	Marianna Verett

APPENDIX D. TACTICAL HORIZON DEMONSTRATION

Tactical Horizon Extension

Sunday, 13 August, 2006	Practice Flights	1400-1600
Monday, 14 August, 2006	Practice Flights	0900-1100 & 1400-1600
Tuesday, 15 August, 2006	Tactical Horizon Extension 1	0800-1000
Thursday, 17 August, 2006	Tactical Horizon Extension 2	0800-1000

Brief Overview

SOLIC Thesis students Major John Glass and Major Kent Landreth have joined with the NPS SUAV Research Team and the NPS CENETIX to demonstrate the transfer of UAS/UAV control between a ground control station (GCS/control van), a manned fixed wing aircraft (CIRPAS Pelican) and a forward deployed ground team, to create target development capability using tactical ISR assets. The intent is to use a wireless ITT Mesh network (2.4GHz) amplified to 1W in order to control the UAS and view streaming video. The Pelican will have an operator (Major Glass), laptop configured with mesh card and 1 W amplifier connected to an externally mounted 2 dBi antenna. The forward deployed ground team will have a similarly configured laptop with a portable 3 dBi antenna. The UAS will be launched manually and control passed to the GCS, who will then assume aircraft/payload (camera) control via the NPS developed Situational Awareness software and server. The Pelican will assume UAS control via SA and recon the objective area—simulating BLOS from the GCS—and then send the UAS to a pre-planned waypoint, where the ground team will assume control through the SA server and return the UAS to the objective area for further target development. The TOC will monitor video and provide scenario updates based on information gathered through mesh video feeds. UAS control will then be returned to the Pelican and GCS respectively for a manual landing at the airfield.

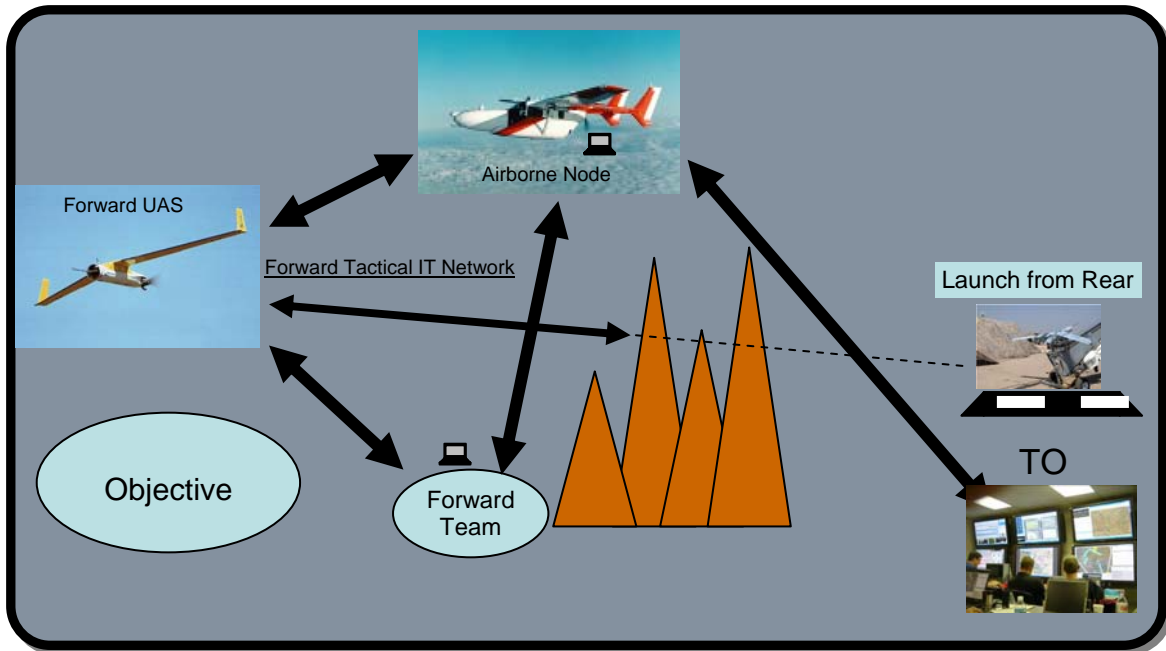

Info Flow and Spatial Orientation

Objectives:

1. Establish effective UAS control via mesh network (airframe and camera) from airborne and remote ground stations:
 - Add UAS waypoints and change flight parameters
 - Manipulate on board camera for target recon
2. Evaluate video quality to determine aircraft and sensor capabilities.
3. Use mesh to supply real-time video to Pelican, Ground Team and TOC for simulated ISR target development.
4. Manipulate mesh nodes to simulate BLOS between parties.

MOPs/MOEs:

1. Safely transfer UAS and camera control between GCS and Pelican.
2. Safely transfer UAS and camera control between Pelican and ground control Team.
3. Image quality for target development and UAS/sensor control.
4. Functionality of hardware and software for future development and field application.

Responsibilities:

LCDR Gordo Cross (USSOCOM)
 Mr. Sam Nickels (AFSOC)
 Dr. Dave Netzer (NPS)
 Dr. Kevin Jones (NPS)
 Dr. Vladimir Dobrokhodov (NPS)
 Dr. Isaac Kaminer (NPS)
 Mr. Eugene Bourakov (NPS)

- TOC CO
 - Air Boss, Flight Safety
 - Experiment Director
 - NPS SUAV
 - NPS SA

Major John Glass	, USAF (NPS)	- Pelican Payload Operator
Major Kent Landreth	, USAF (NPS)	- Ground Team Operator
QMC Darren Anderson	(NSWC)	- Stitched Images
Ground Observers		- TBD

Timeline:

The practice flights will begin on the established times but may end earlier or later based on the progress of the checks. The Pelican will be used for ground checks on Monday morning but may/may not be used for flights in the afternoon.

Depending on the progress of the test flights, the **Tactical Horizon Extension 1** objectives and timeline may be changed to replicate the **Tactical Horizon Extension 2** objectives and timeline. Decision to be made by 1700, Monday 14 August.

Sunday 13 August, 2006: Practice Flight 1

1300	- GCS/Control Van, Pelican Laptop, Ground Team Laptop and NPS UAS set-up, connectivity and control checks
1400	- NPS UAS Take-Off
1410	- GCS assumes control (using SA) of UAS and establishes orbit over runway
1430	- John Glass (co-located at van), using Pelican laptop assumes control (using SA) of UAS and sends waypoint of resolution target to UAS and establishes orbit—practices target reconnaissance
1450	- Kent Landreth (co-located at van), using Ground Team laptop assumes control (using SA) of UAS and sends waypoint of west end of RWY 28 to UAS and establishes orbit—practices target reconnaissance
1510	- GCS assumes control (using SA) of UAS and sends waypoint of GCS to UAS and establishes orbit
1520-1555	- Repeat the above as necessary
1555	- Transfer control of UAS to manual for landing
1600	- Land

Monday, 14 August, 2006: Practice Flight 2

0800	- GCS, Pelican Laptop, Ground Team Laptop and NPS UAS set-up, connectivity and control checks
0900	- NPS UAS Take-Off
0910	- GCS assumes control (using SA) of UAS and establishes orbit over runway
0930	- John Glass (co-located at van), using Pelican laptop assumes control (using SA) of UAS and sends waypoint of west end of RWY 28 to UAS and establishes orbit—practices target reconnaissance

- 0950 - Kent Landreth (co-located at van), using Ground Team laptop assumes control (using SA) of UAS and sends waypoint of resolution target to UAS and establishes orbit—practices target reconnaissance
- 1010 - GCS assumes control (using SA) of UAS and sends waypoint of GCS to UAS and establishes orbit
- 1020-1055 - Repeat the above as necessary
- 1055 - Transfer control of UAS to manual for landing
- 1100 - Land

Monday, 14 August, 2006: Practice Flight 3

- 1300 - GCS, Pelican Laptop, Ground Team Laptop and NPS UAS set-up, connectivity and control checks
- 1400 - NPS UAS Take-Off
- 1410 - GCS assumes control (using SA) of UAS and establishes orbit over runway
- 1430 - John Glass (co-located at van), using Pelican laptop assumes control (using SA) of UAS and sends waypoint of resolution target to UAS and establishes orbit—practices target reconnaissance
- 1450 - Kent Landreth (co-located at van), using Ground Team laptop assumes control (using SA) of UAS and sends waypoint of west end of RWY 28 to UAS and establishes orbit—practices target reconnaissance
- 1510 - Control Van assumes control (using SA) of UAS and sends waypoint of Control Van to UAS and establishes orbit
- 1520-1555 - Repeat the above as necessary
- 1555 - Transfer control of UAS to manual for landing
- 1600 - Land
- 1700 - Decision to TOC/Air Boss on which scenario to be flown on Tuesday
- 1730 - Using Stitched Video from Raven – TOC Identifies Potential Target for further ISR flights—Tasks NPS UAS, Pelican and Ground Team to prepare for mission to be conducted Thursday (Tuesday if schedule is changed at the 1700 Update)
- 1800 - Connectivity checks with static Pelican, Van and Ground Team in Tuesday configurations

Tuesday, 15 August, 2006: Tactical Horizon Extension 1

- 0600 - Pelican Pre-flight, NPS UAS preparation and connectivity checks at hanger with Van, Pelican, Ground Team and TOC
- 0800 - Ground Team “deploys” to west end of RWY 28 (maintains 50’ from RWY)
- 0800 - Pelican Departs—Establishes orbit over airfield
- 0805 - GCS moves into position on RWY in preparation for UAS takeoff
- 0815 - NPS UAS departs under manual control
- 0820 - GCS takes control of UAS through SA and establishes orbit over airfield
- 0830 - Pelican takes control of UAS using SA and sends waypoint of resolution target to UAS and establishes orbit—practices target reconnaissance

- 0845 - TOC identifies target via mesh video—requests ground eyes on and further target recon
- 0850 - Ground Team reports to TOC “eyes on” target requests UAS support; gives current position
- 0852 - TOC contacts Pelican—directs transition of UAS to Ground team location
- 0855 - Pelican sends Ground Team current position as waypoint to UAS
- 0900 - Ground Team takes control through SA and sends target waypoint (res target) to UAS
- 0905 - Ground Team recons target area
- 0920 - TOC acknowledges target information and directs RTB of UAS and Pelican
- 0930 - Pelican re-takes control of UAS and sends GCS waypoint and establishes orbit over airfield
- 0940 - GCS re-takes control of UAS and prepares for landing
- 0950 - UAS lands clears runway
- 1000 - Pelican Lands
- 1030 - Hot Wash

Thursday, 17 August, 2006: Tactical Horizon Extension 2

- 0600 - Pelican Pre-flight, NPS UAS preparation and connectivity checks at hanger with Van, Pelican, Ground Team and TOC
- 0745 - Ground Team “deploys” to OP (N35.45.294 W120.46.767)
- 0800 - Pelican Departs—Establishes orbit at Pelican West Hold Point (location TBD)
- 0805 - GCS moves into position on RWY in preparation for UAS takeoff
- 0815 - NPS UAS departs under manual control
- 0820 - GCS takes control of UAS through SA and establishes orbit over airfield
- 0830 - Pelican takes control of UAS using SA and sends waypoint of target (N35.45.347 W120.46.394) to UAS
- 0845 - UAS establishes orbit over target—Pelican begins target recon
- 0855 - TOC identifies target via mesh video—requests ground eyes on and further target recon
- 0900 - Ground reports to TOC “eyes on” target requests UAS support gives, current position
- 0903 - TOC contacts Pelican—directs transition of UAS to Ground team
- 0905 - Pelican sends West Holding position (Location TBD) as waypoint to UAS
- 0910 - Ground team takes control through SA and sends target waypoint (N35.45.347 W120.46.394) to UAS
- 0915 - Ground Team recons target area
- 0925 - TOC acknowledges target information and directs RTB of UAS and Pelican
- 0930 - Ground Team sends West Hold Point (Location TBD) waypoint to UAS
- 0935 - Pelican re-takes control of UAS and sends airfield waypoint to UAS

0945 - GCS re-takes control of UAS and prepares for landing
0950 - UAS lands clears runway/GCS clears runway
1000 - Pelican Lands
1030 - Hot Wash

LIST OF REFERENCES

Chairman of the Joint Chiefs of Staff, "National Military Strategic Plan for the War on Terrorism," (2006): 22-29, <http://www.defenselink.mil/qdr/docs/2005-01-25-Strategic-Plan.pdf> , September 2006.

Snyder, Don, Patrick Mills, Manuel Carrillo, and Adam Resnick. *Supporting Air and Space Expeditionary Forces: Capabilities and Sustainability of Air and Space Expeditionary Forces*. Santa Monica: Rand, 2006.

THIS PAGE INTENTIONALLY LEFT BLANK

INITIAL DISTRIBUTION LIST

1. Defense Technical Information Center
Ft. Belvoir, Virginia
2. Dudley Knox Library
Naval Postgraduate School
Monterey, California