



Calhoun: The NPS Institutional Archive
DSpace Repository

Reports and Technical Reports

Faculty and Researchers' Publications

2010-05-12

Illustrating the CONOPs Continuum and its Relationship to the Acquisition Lifecycle

Edson, Robert; Frittman, Jaime

Monterey, California. Naval Postgraduate School

<https://hdl.handle.net/10945/33538>

This publication is a work of the U.S. Government as defined in Title 17, United States Code, Section 101. Copyright protection is not available for this work in the United States.

Downloaded from NPS Archive: Calhoun



Calhoun is the Naval Postgraduate School's public access digital repository for research materials and institutional publications created by the NPS community. Calhoun is named for Professor of Mathematics Guy K. Calhoun, NPS's first appointed -- and published -- scholarly author.

Dudley Knox Library / Naval Postgraduate School
411 Dyer Road / 1 University Circle
Monterey, California USA 93943

<http://www.nps.edu/library>

Unclassified

ANSER

An Operating Unit of Analytic Services Inc.



Illustrating the CONOPs Continuum and its Relationship to the Acquisition Lifecycle

Presented to: Acquisition Research Symposium

Presenter: Jaime Frittman

Authors: Jaime Frittman & Robert Edson

Date May 12, 2010

Unclassified

Overview

- Motivation for research
- Research goals
- Methodology
- Discussion
 - CONOPs definition
 - Perceptions of CONOPs and barriers to usage
 - Integrating many CONOPs documents
 - Alignment of CONOPs
 - Evolving CONOPs
- Summary

Motivation

- As noted by a recent FAA sponsored study, cost, schedule and performance breaches continue to plague large scale programs
- The FAA study noted the importance of the CONOPs in avoiding programmatic pitfalls

“...one of the most significant artifacts is the creation of a CONOPs.”

Once created, there is a need to have
“...alignment between the evolving CONOPs, the enterprise architecture, and the governance system...”(Turner et. al., 2009, p 32).

Research Goals

- Assess current use of CONOPs
- Identify any disconnect between use and perceived usefulness
- Assess current alignment of CONOPs to DOD governance and EA processes
- Explore maturity phases of CONOPs

Methodology

- Literature review
 - DoD instructions and manuals
 - Industry standards
 - Websites
 - Academic papers and surveys
- Analysis
 - 4-way data analysis of:
 - usage, terms, purposes, and relationships
- Systems thinking
 - Conceptagon application

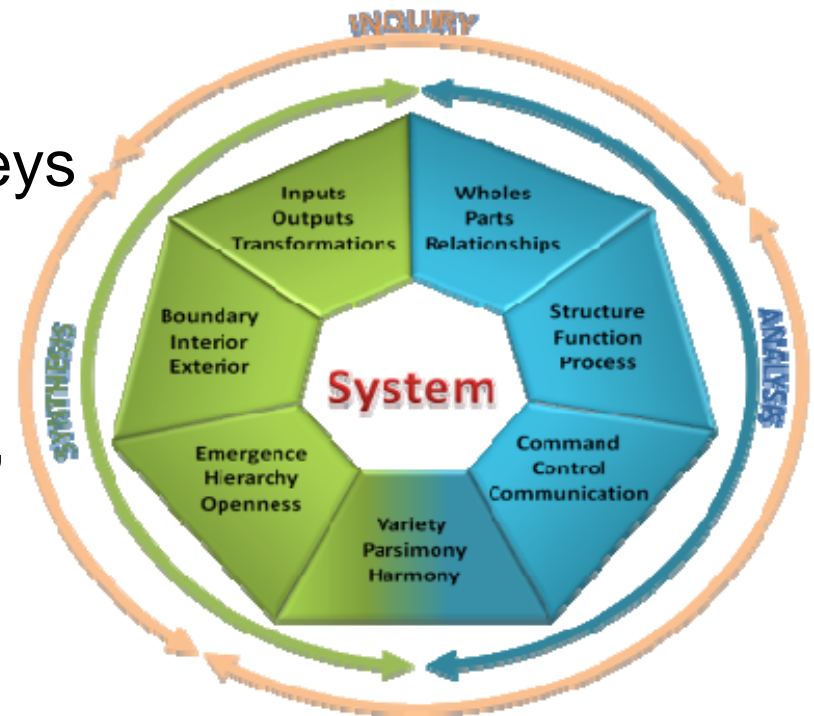

(Edson, 2008)

A CONOPs Is....

- IEEE Std 1362-1998
 - A user-oriented document that describes system characteristics for a proposed system from the users' viewpoint.
- Joint Pub 1-02
 - A verbal or graphic statement that clearly and concisely expresses what the joint force commander intends to accomplish and how it will be done using available resources... designed to give an overall picture of the operation.
- CJCSI 3010.02B
 - How a joint force commander may organize and employ forces in the near term (now through 7 years into the future) in order to solve a current or emerging military problem...CONOPs provide the operational context needed to examine and validate current

Perceptions of CONOPs Use

- Government community survey
 - Respondents indicated CONOPs as
 - “Critical” to system success and “Underutilized”
- Industry community survey (Roberts, 2008)
 - 108 respondents primarily engineers
 - 100% of respondents said they found a CONOPs useful
 - 1/3 of programs surveyed did not have a CONOPs
 - 18% of CONOPs generated after requirements

Barriers to Effective CONOPs Use

- Disconnect: perceived importance vs. use
- Research indicated 4 related causes of the disconnect
 - Definition and purpose
 - Targeted audience
 - Timing and placement in the acquisition development lifecycle
 - Comprehensive view and consistent involvement by stakeholders

Relationship of CONOPs to Acquisition

- JCIDS and DoD, “CONOPs” usually refers to a military concept

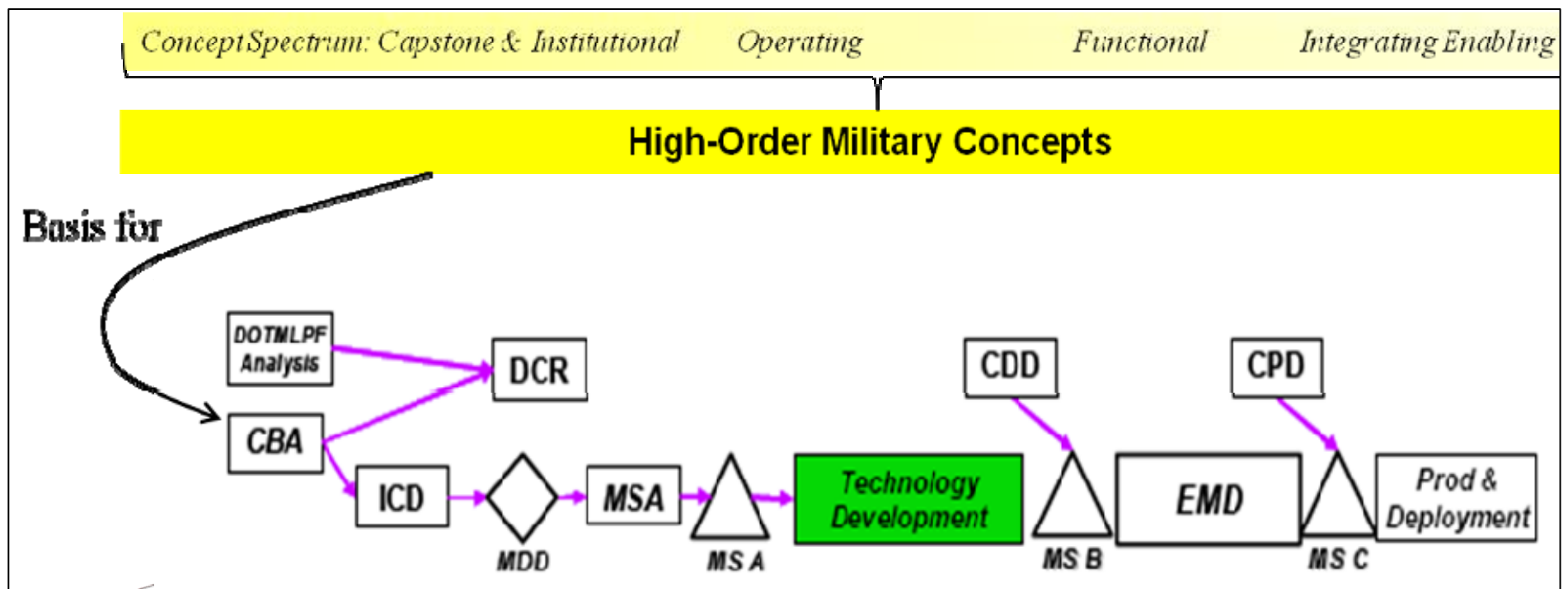

Relationship of CONOPs to Acquisition

- DoD 5000.02
 - Validated assessment of the relationship of Military Concepts
 - Did not specify relationship of system level CONOPs

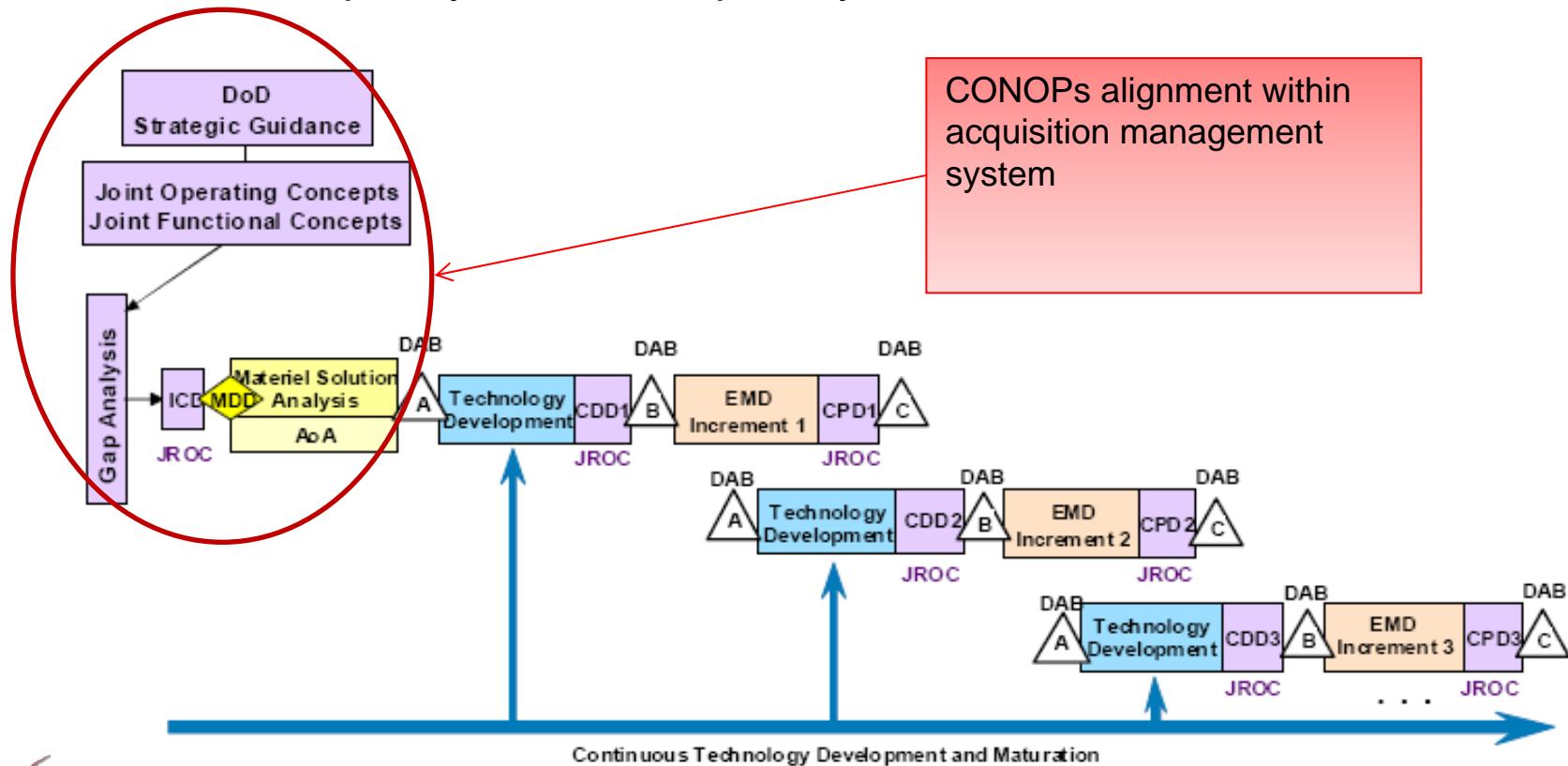

Relationship of CONOPs to Acquisition

- DoD literature review described several more CONOPs related documents
 - These were plotted on the existing enterprise architecture/ governance framework

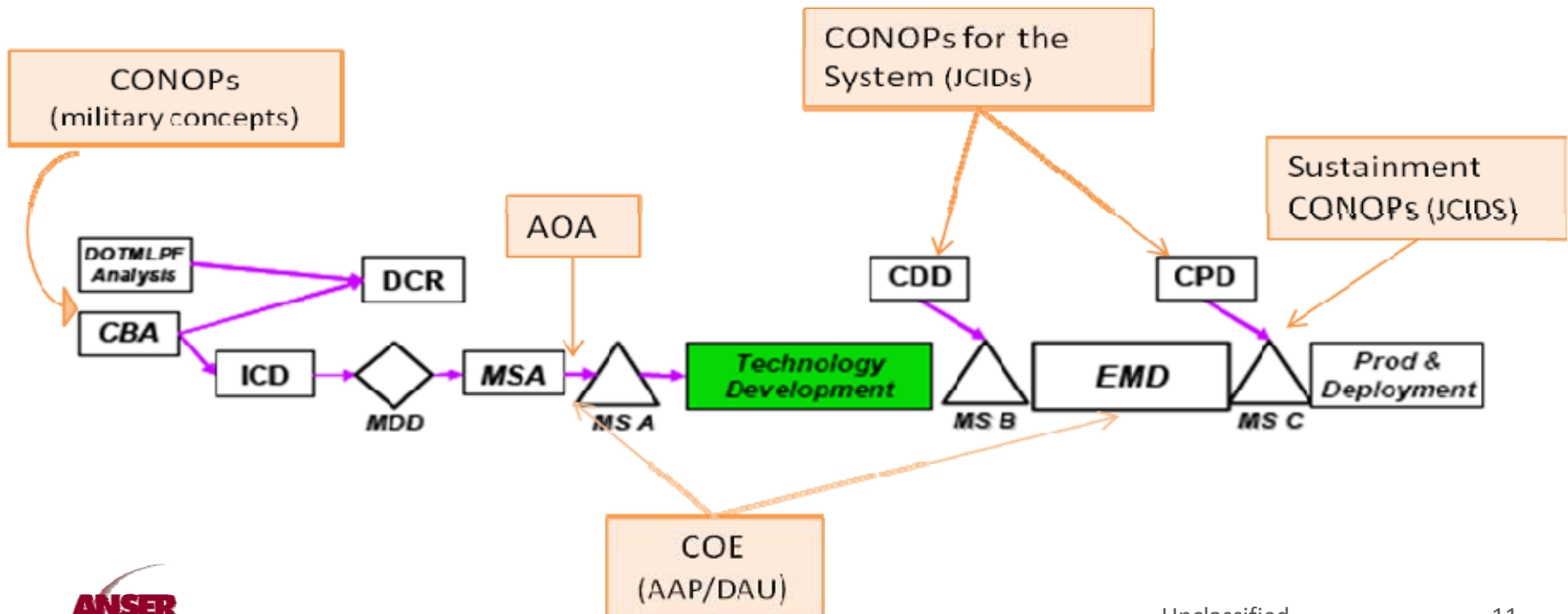

Relationship of CONOPs to Acquisition

- Plot was increased to include documents referenced in literature
 - Substantial increase in documents spanning lifecycle

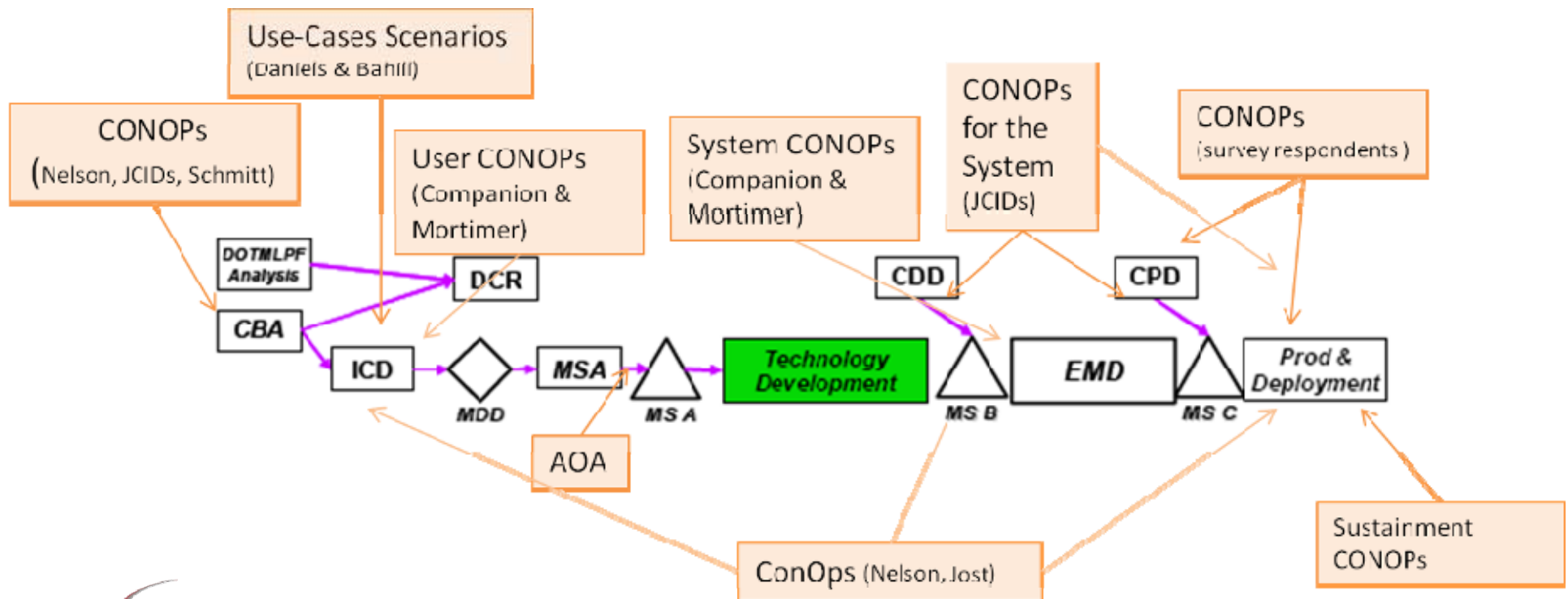

Integration of Individual Inputs and IEEE's standard

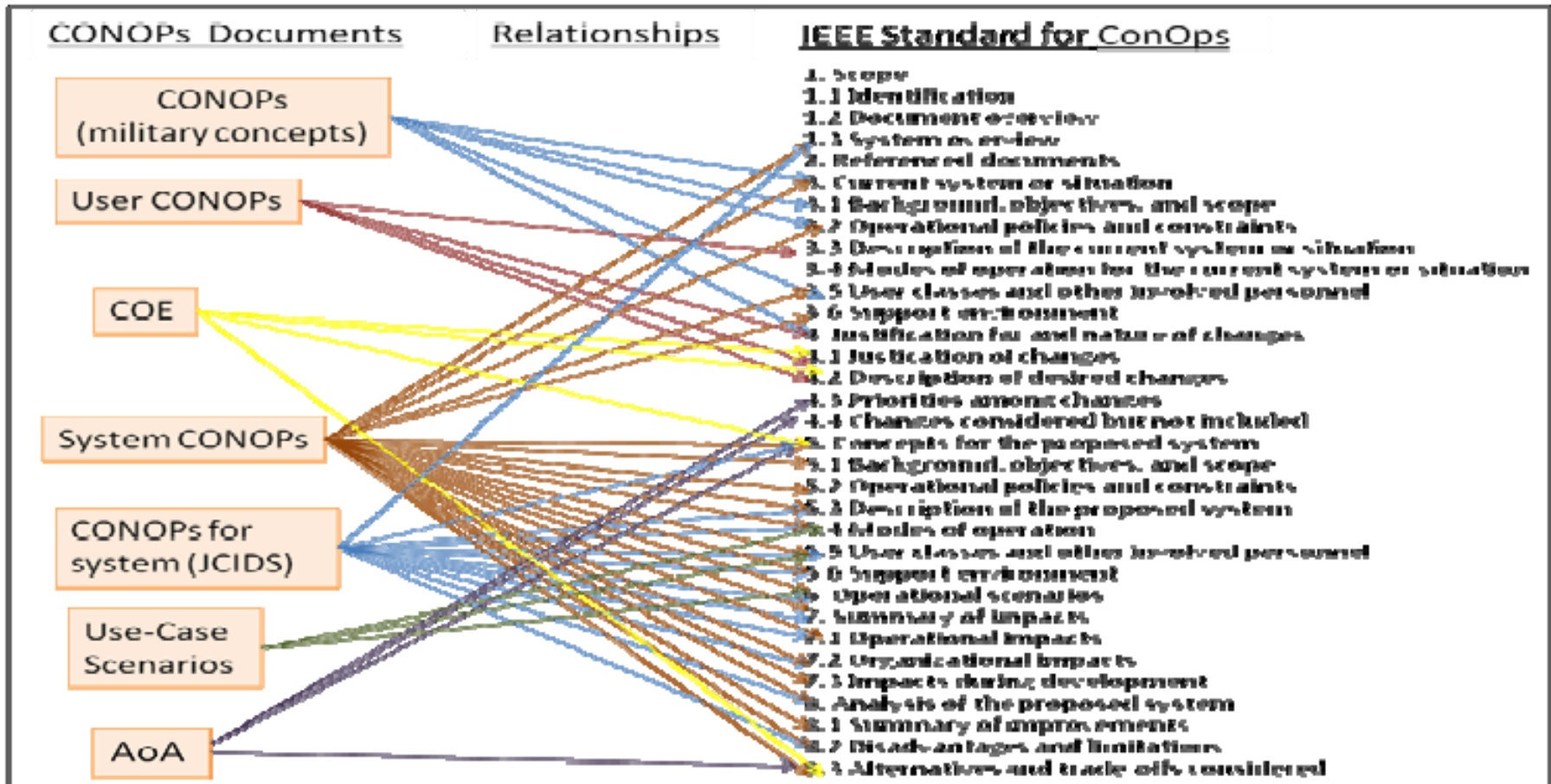

“The main reason we overlook the central role of the CONOP...is that we give different names to the same thing at different scales”(Nelson, 2007)

Value of Integrated CONOPs

- Traceability
 - “Key tool for ensuring that the system developed fully meets the needs and requirements defined by the user” (IEEE, 2008, para, 4.2, p., 38)
 - Integration resolves, or mitigates, potentially conflicting views by creating a “one stop” complete view of the problem, the proposed solution, the user community, and the intended uses.
- Continuity
 - Key tool for stakeholder involvement and communication
 - Retains comprehensive view of stakeholder input

Alignment of the Integrated CONOPs

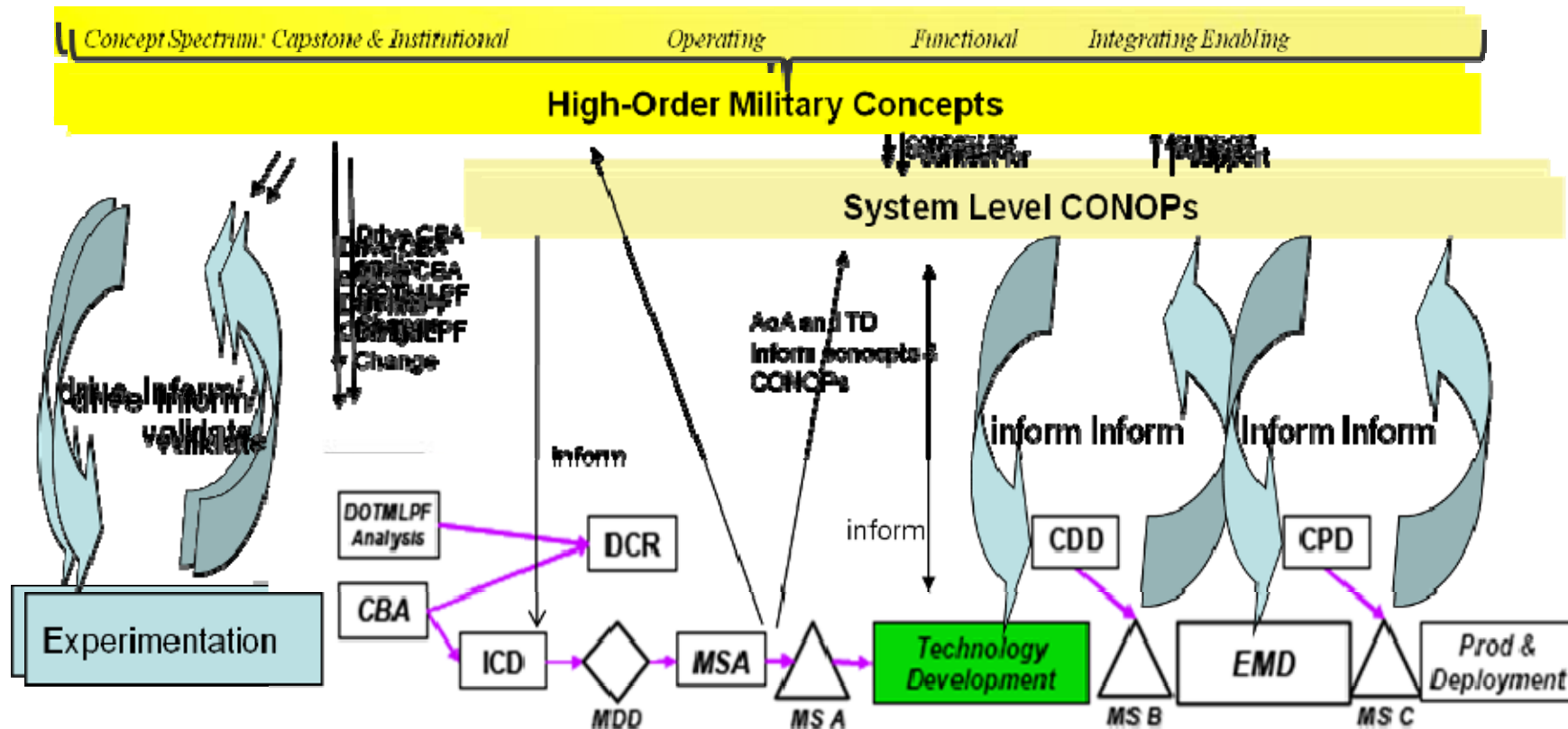

CONOPs Maturity Phases

- Alignment of CONOPs, EA, and governance systems, brought to light specific phases of CONOPs maturity
 - Black box to white box description
- CONOPs matures in concert with system
 - Maturity phases align with major phases of lifecycle

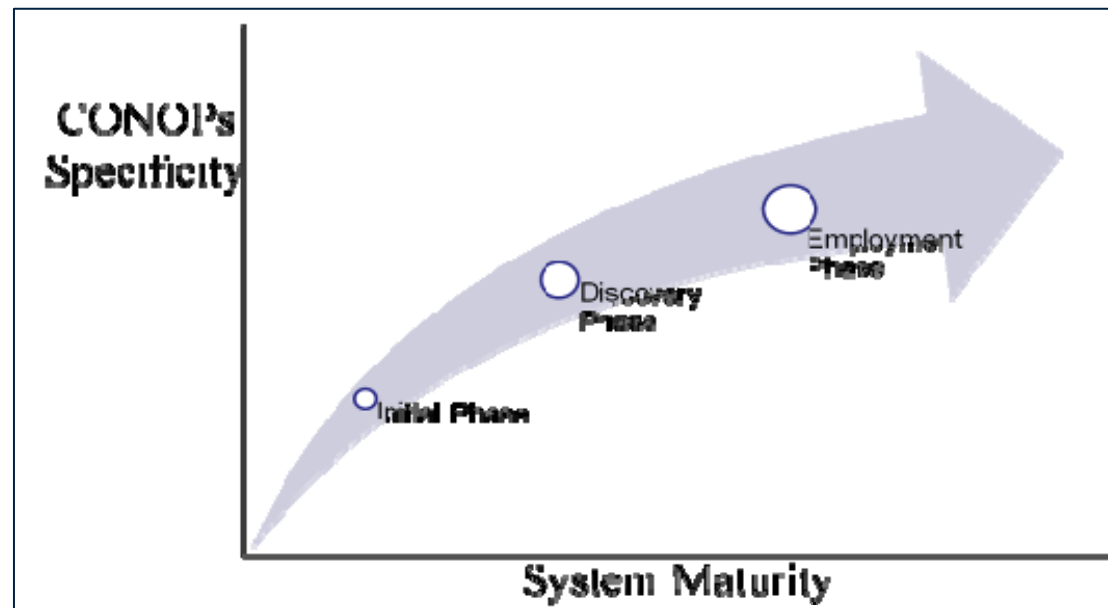

CONOPs Maturity Phases

- Initial Phase
 - Describes the system as a 'black box' and in its most ideal form.
 - Guides development of ICD requirements
- Discovery Phase
 - Informed by the Technology Development & EMD
 - Basis for requirements captured in the CDD & CPD
- Employment Phase
 - Informed by user feedback
 - Most specific version of the CONOPs

CONOPs Maturity Phases

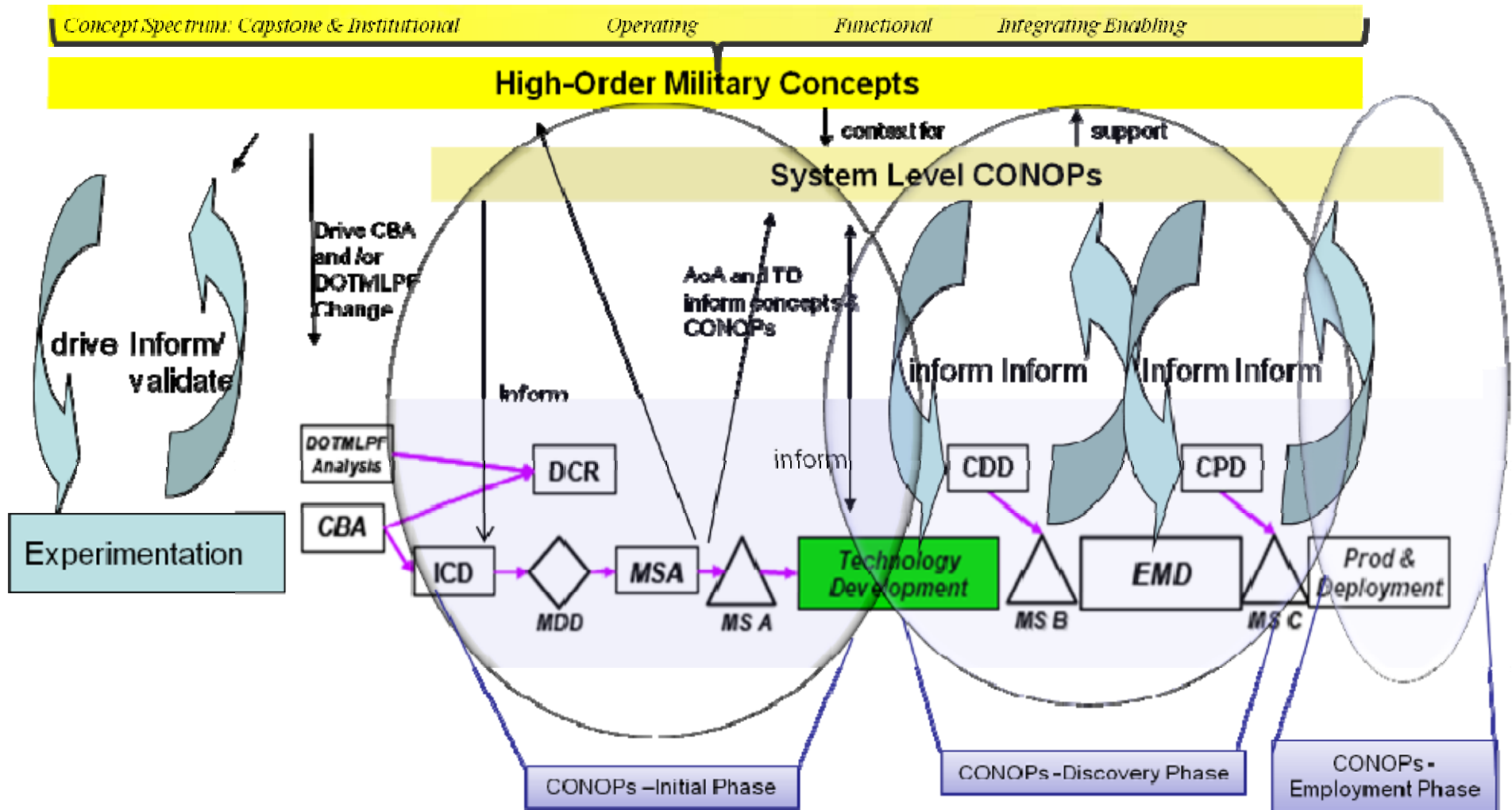

Summary

- Several barriers that prevent effective CONOPs usage
 - Definition and purpose, intended audience, placement in acquisition cycle, and lack of a comprehensive view
- CONOPs, even if in a broken form are being used across the acquisition lifecycle
 - An opportunity exists to integrate these documents in an end-to-end CONOPs
- CONOPs mature with the system

References

- Ask a Professor (APP). (2009, May 20). Question & Answer Detail Program Management. Retrieved November 2009, from Defense Acquisition University: <https://akss.dau.mil/askaprof-akss/qdetail2.aspx?cgiSubjectAreaID=9&cgiQuestionID=28681>
- Bahill, T.H., Henderson, S.J. (2005). Requirements Development, Verification, and Validation Exhibited in Famous Failures. *Systems Engineering*, 8 (1), pp. 1-12. Retrieved, October 2009, from www.sie.arizona.edu/sysengr/publishedPapers/famousFailures.pdf
- Chairman of the Joint Chiefs of Staff Instruction. (2006, January 27). "Joint Operations Concepts Development Process (JOpsC-DP)." CJCSI 3010.02B.
- Companion, M., Mortimer, C. (n.d.). Designing for change: A modeling and simulation system approach. Arlington, Texas: Raytheon Systems. Available at, www.link.com/pdfs/itsec2.pdf
- Daniels, J. & Bahill, T. (2004, July 7). The Hybrid Process that Combines Traditional Requirements and Use Cases. *Systems Engineering*, 7 (4), pp. 303-319. Retrieved October 2009, from www.sie.arizona.edu/sysengr/publishedPapers/hybridProcess.pdf
- Department of Defense (DoD). (2008). Instruction 5000.02 "Operation of the Defense Acquisition System." December 8, 2008.
- Edson, R. (2008). Systems Thinking. Applied. A Primer. Arlington, VA: Analytic Services, Inc.
- IEEE Standards Board. (1998). IEEE Standard 1362-1998, IEEE Guide for Information Technology-System Definition- Concept of Operations (ConOps) Document. Standard. New York. Institute of Electric and Electronics Engineers, Inc., 1998.

References

- IEEE Press/Standards Information Network. (2008, November 4). Guide for Implementing IEEE Std 1512™ Using a Systems Engineering Process. Prepared for Federal Highway Administration (FHWA) & Institute of Electrical and Electronics Engineers (IEEE); ISBN 978-0-7381-5674-3. Available at, <http://standards.ieee.org/standard/press/>.
- Joint Capabilities and Development System (JCIDS). (2009). "Manual for the Operation of the Joint Capabilities Integration and Development System."
- Joint Publication 1-02. "Department of Defense Dictionary of Military and Associated Terms." 12 April 2001 as amended through October 2008.
- Jost, A. (2007, October). ConOps: The Cryptex to Operational System Mission Success. *Cross Talk The Journal of Defense Software Engineering*, 20 (10), 13-16. Available at, www.stsc.hill.af.mil/crosstalk/2007/10/0710Jost.html
- Nelson, G. (2007). The ConOps in a Self-Similar Scale Hierarchy for Systems Engineering (Paper # 69). *Conference on Systems Engineering Research*. Hoboken, NJ.
- Roberts, N. (2008). An Analysis of Concept of Operation Development (Master's Thesis, Steven's Institute of Technology, 2008).
- Schmitt, J. (2002, December) A Practical Guide for Developing and Writing Military Concepts. Defense Adaptive Red Team Working Paper. McClean VA: Hicks and Associates, Inc. Available at, www.au.af.mil/au/awc/awcgate/dod/dart_guide.pdf
- Turner, R., Verma, D., & Weitekamp, M. (2009). "The Next Generation Air Transportation System (NextGen)." School of Systems and Enterprises. Stevens Institute of Technology.