



Calhoun: The NPS Institutional Archive
DSpace Repository

Faculty and Researchers

Faculty and Researchers' Publications

1993

Slew Maneuver of a Flexible Spacecraft Using On-Off Thrusters

Bang, H.; Agrawal, B.N.

AIAA Guidance, Navigation, and Control Conference, Monterey, CA, August 9-11, 1993, pp. 224-233.

<http://hdl.handle.net/10945/34478>

This publication is a work of the U.S. Government as defined in Title 17, United States Code, Section 101. As such, it is in the public domain, and under the provisions of Title 17, United States Code, Section 105, is not copyrighted in the U.S.

Downloaded from NPS Archive: Calhoun



Calhoun is the Naval Postgraduate School's public access digital repository for research materials and institutional publications created by the NPS community. Calhoun is named for Professor of Mathematics Guy K. Calhoun, NPS's first appointed -- and published -- scholarly author.

Dudley Knox Library / Naval Postgraduate School
411 Dyer Road / 1 University Circle
Monterey, California USA 93943

<http://www.nps.edu/library>

SLEW MANEUVER OF A FLEXIBLE SPACECRAFT USING ON-OFF THRUSTERS

Brij N. Agrawal[†] and Hyochoong Bang[‡]
Naval Postgraduate School, Monterey, CA 93943

Abstract

A closed loop switching function for single-axis slew maneuvers of spacecraft using on-off thrusters is investigated by analytical simulations and experimental demonstrations. The proposed switching function provides flexibility of controlling multiple firing and pointing errors in the presence of modelling errors and structural flexibility. The proposed switching functions for three-axis maneuver of a rigid body are also investigated by analytical simulations. The analytical and experimental results show that the proposed switching function can result in significant improvement of the slew maneuver performance.

I. Introduction

Slew maneuvers of flexible spacecraft have received significant attention during the past decade.¹⁻⁴ The performance criteria are minimization of fuel consumption, slew time, and vibration of flexible structures. Several control schemes have been proposed for these maneuvers.¹⁻⁸ These control schemes, however, have been primarily open loop and used for single axis slew maneuvers.

Singh⁵ solved a minimum-time slew problem mathematically for the planar maneuvers of a flexible structure. The open loop switching times are functions of the system parameters and are symmetric with respect to half maneuver time for a rest-to-rest maneuver. Vander Velde⁶ and Hablani⁷ solved the problem for zero residual energy. In all these formulations, however, modelling errors are neglected. Liu and Wie⁸ have proposed an open loop switching schemes to enhance the robustness of the control in the presence of modelling errors. The major drawback of the open loop control schemes discussed earlier is that they are sensitive to modelling errors and unmodeled external disturbance

torques. Also, the implementation of these control laws may be also difficult. Therefore, there is a need to develop simple closed-loop control schemes for slew maneuvers of flexible spacecraft using thrusters. For a rigid spacecraft, switching function of thrusters for minimum time slew maneuver is well known.

In this paper, we present the results of a study to use this classical closed loop switching function for rigid and flexible spacecraft with modelling errors and propose a modified switching function. The analytical simulation results using these switching functions for three-axis slew maneuvers of a rigid spacecraft are also presented. The paper also includes experimental and analytical results for Flexible Spacecraft Simulator(FSS) slew maneuvers using classical and modified switching schemes.

II. Rigid Body Case

For a rigid body undergoing a single axis slew maneuver, the equation of motion is given by

$$I\ddot{\theta} = u \quad (1)$$

where I is the moment of inertia with respect to the rotational axis, θ is rotational angle, and $-N \leq u \leq N$ is the applied external torque. With the following boundary conditions($\theta_f > \theta_0$)

$$\begin{aligned} \theta &= \theta_0 & \dot{\theta} &= 0 & \text{at } t &= 0 \\ \theta &= \theta_f & \dot{\theta} &= 0 & \text{at } t &= t_f \end{aligned}$$

the minimum-time(t_f) solution for a rest-to-rest maneuver is "bang-bang" law which is anti-symmetric about the half-maneuver time⁹

$$u = \begin{cases} N, & \text{if } 0 \leq t \leq t_f/2 \\ -N, & \text{if } t_f/2 < t \leq t_f \\ 0, & \text{if } t_f < t \end{cases} \quad (2)$$

In addition, the maneuver time, t_f , is given by

$$t_f = \sqrt{\frac{4I(\theta_f - \theta_0)}{N}} \quad (3)$$

The control law of Eq. (2) can be written in the feedback form

$$\begin{aligned} u(t) &= -N \operatorname{sgn}[s(t)], & s(t) &= \left[\tilde{\theta} + \frac{I\dot{\theta}|\dot{\theta}|}{2N} \right] \\ &= -N \operatorname{sgn}[\dot{\theta}] \end{aligned} \quad (4)$$

[†] Professor, Department of Aeronautics/Astronautics, Associate Fellow AIAA

[‡] Research Assistant Professor, Department of Aeronautics/Astronautics, Member AIAA

where $\tilde{\theta} = \theta - \theta_f$, and $\text{sgn}[f] = 1(-1)$, if $f > (<) 0$.

During the maneuver, the solutions for $u, \dot{\theta}, s$, and θ are well known, and can be obtained analytically. Furthermore, the switching function $s(t)$ is given by, for $0 < t \leq \frac{t_f}{2}$

$$\begin{aligned} s(t) &= \frac{N}{I}t^2 - \theta_f \\ \dot{s}(t) &= \frac{2N}{I}t = 2\dot{\theta} \end{aligned} \quad (5)$$

and for $\frac{t_f}{2} < t \leq t_f$

$$\begin{aligned} s(t) &= 0 \\ \dot{s}(t) &= 0 \end{aligned} \quad (6)$$

For $s(t) \neq 0$, the control law can be written as

$$\begin{aligned} u(t) &= -N \frac{s(t)}{|s(t)|} = -N \frac{1}{|s(t)|} \tilde{\theta} - \frac{I}{2|s(t)|} |\dot{\theta}| \dot{\theta} \\ &= -g_1(t)\tilde{\theta} - g_2(t)\dot{\theta} \end{aligned} \quad (7)$$

Therefore, the control law of Eq. (5) is a nonlinear feedback law for $\theta, \dot{\theta}$ using nonlinear time varying feedback gains $(g_1(t), g_2(t))$. Note, however, that the control law still has an open loop characteristic due to the discontinuous on-off actuator. Although the feedback gains (g_1, g_2) are positive, asymptotic stability is not guaranteed because the gains are not constant. The necessary stability condition for the time varying closed loop system described by¹⁰

$$I\ddot{\theta} + \frac{I}{2|s(t)|} |\dot{\theta}| \dot{\theta} + \frac{N}{|s(t)|} \tilde{\theta} = 0 \quad (8)$$

is stated as¹⁰

$$(i) \frac{1}{|s(t)|} > 0, \quad (ii) \frac{d}{dt} \frac{1}{|s(t)|} \leq 0, \quad (iii) \frac{I}{|s(t)|} |\dot{\theta}| \geq 0 \quad (9)$$

In the above three conditions, condition (ii) is not satisfied because

$$\frac{d}{dt} \frac{1}{|s(t)|} = \begin{cases} 0, & \text{if } s > 0, \quad \dot{\theta} > 0 \\ -2\dot{\theta} \frac{1}{s^2} > 0 & \text{if } s > 0, \quad \dot{\theta} < 0 \\ 0 & \text{if } s < 0, \quad \dot{\theta} < 0 \\ 2\dot{\theta} \frac{1}{s^2} > 0 & \text{if } s < 0, \quad \dot{\theta} > 0 \end{cases} \quad (10)$$

Therefore, the control law of Eq. (5) is not an asymptotically stabilizing control law.

Now let us consider robustness of the switching function. Let us consider that there is an error in the estimation of inertia I and thruster torque N . The switching function is given by

$$\begin{aligned} s_\gamma(t) &= \left[\tilde{\theta} + \frac{I(1 + \epsilon_1)}{2N(1 + \epsilon_2)} \dot{\theta} |\dot{\theta}| \right] \\ &= \left[\tilde{\theta} + \gamma \frac{I}{2N} \dot{\theta} |\dot{\theta}| \right] \end{aligned} \quad (11)$$

where $\gamma = (1 + \epsilon_1)/(1 + \epsilon_2)$. The new switching function $s_\gamma(t)$ will have the following characteristics. Let t_1 be the time when the switching function $s_\gamma(t)$ reaches zero. It is given by

$$t_1 = \sqrt{\theta_f \frac{2I}{N(1 + \gamma)}} \quad (12)$$

For $0 \leq t \leq t_1$, and $u(t) = N$

$$s_\gamma(t) = \frac{N}{2I}t^2(1 + \gamma) - \theta_f \quad (13)$$

and

$$\dot{s}_\gamma(t) = \frac{Nt}{I}(1 + \gamma) \quad (14)$$

On the other hand, for $t_1 \leq t$, and $u = -N$

$$\dot{s}_\gamma(t) = (1 - \gamma)\dot{\theta} \quad (15)$$

For $\gamma > 1$, \dot{s}_γ will be negative causing s_γ to be negative followed by a firing with $u = N$. Therefore, for $\gamma > 1$, there will be multiple firings of thruster in both directions for $t > t_1$. For $\gamma < 1$, \dot{s}_γ will be positive with positive s_γ , avoiding multiple firings. Therefore, γ plays an important role in thruster firings for $t > t_1$. Based on these considerations, we propose a modified switching function as

$$s_\gamma(t) = \tilde{\theta} + \gamma \frac{I\dot{\theta}|\dot{\theta}|}{2N} \quad (16)$$

Figure 1 presents the analytical simulation results for a rigid body slew maneuver with the modified switching function. The estimated inertia is $11.4 \text{ Kg} - m^2$ instead of actual value of $13.1 \text{ Kg} - m^2$. The thruster torque is 0.3 N-m and the desired final angle, θ_f , is 60 degrees. The simulations were done for γ equal to $0.8, 1$, and 1.2 . It is shown that for γ equal to 1.2 , slew maneuver time and multiple firings increase, but the pointing error at the end of maneuver time is significantly reduced.

III. Application to Three Axis Maneuver

The proposed control law can be extended to the case of a three axis maneuver of a rigid body. There have been several intensive studies on the open loop controls for the three axis rigid body maneuver. However, not much attention has been paid to the closed loop switching control approach due to the complexity of finding an analytical expression for the nonlinear switching functions. The closed loop switching function technique implies similar advantages over the open loop approach as in the case of single axis maneuver.

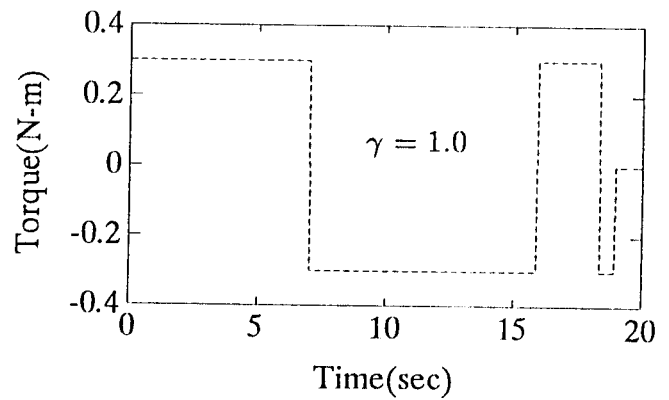
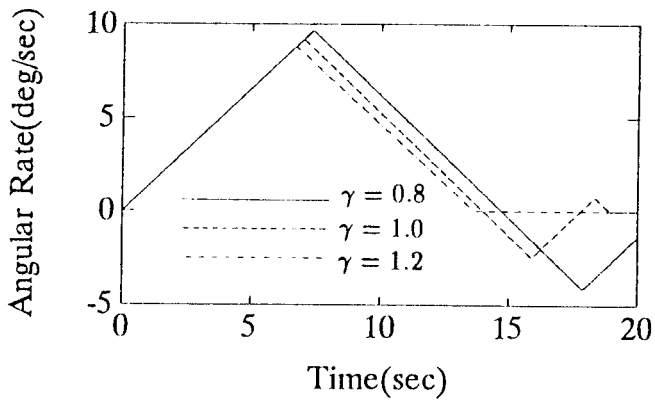
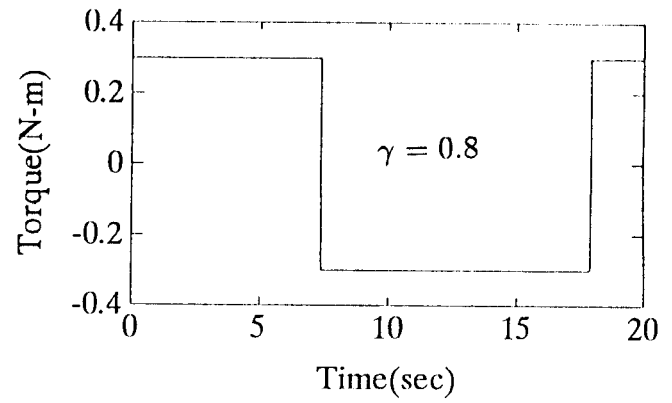
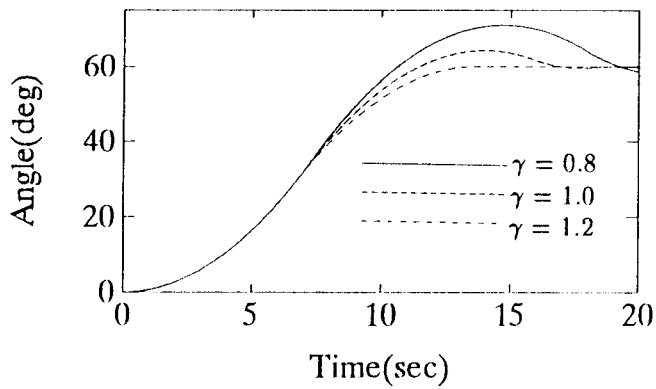

Figure 1 Single axis rigid body maneuver

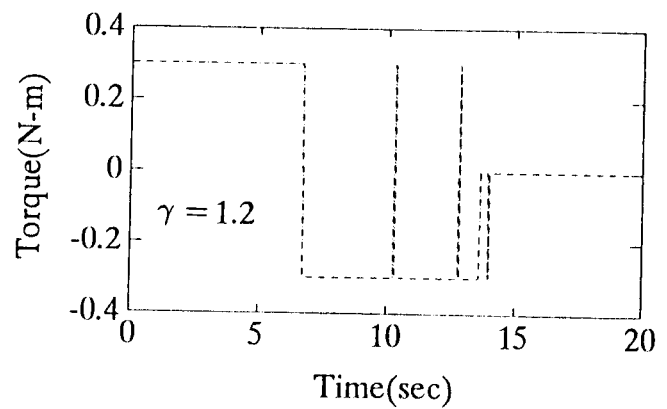

Figure 1 (continued)

Motivated by the modified switching law, we hypothesize a set of switching functions associated with each body axis.

The governing equations of motion for a three axis rigid body maneuver are known as

$$\begin{aligned} I_1 \dot{\omega}_1 &= (I_2 - I_3)\omega_2\omega_3 + u_1 \\ I_2 \dot{\omega}_2 &= (I_3 - I_1)\omega_3\omega_1 + u_2 \\ I_3 \dot{\omega}_3 &= (I_1 - I_2)\omega_1\omega_2 + u_3 \end{aligned} \quad (17)$$

and the kinematic relationships are

$$\begin{Bmatrix} \dot{q}_1 \\ \dot{q}_2 \\ \dot{q}_3 \end{Bmatrix} = \frac{1}{2} \begin{bmatrix} 1 + q_1^2 & q_1 q_2 - q_3 & q_1 q_3 + q_2 \\ q_1 q_2 + q_3 & 1 + q_2^2 & q_2 q_3 - q_1 \\ q_1 q_3 - q_2 & q_2 q_3 + q_1 & 1 + q_3^2 \end{bmatrix} \begin{Bmatrix} \omega_1 \\ \omega_2 \\ \omega_3 \end{Bmatrix}$$

where q_i are the Euler-Rodriguez parameters (or "Gibbs vector"), I_i are principal moment of inertia, ω_i are principal axis components of angular velocity, and u_i are principal axis components of the external torque. For the above system of differential equations of motion, a set of globally stabilizing nonlinear control laws, toward an equilibrium point $[\omega_1, \omega_2, \omega_3, q_1, q_2, q_3] = [0, 0, 0, q_1^f, q_2^f, q_3^f]$, is given in the form¹

$$u_i = -g_i \omega_i - g_0 \tilde{f}_i, \quad g_0 > 0, \quad g_i > 0, \quad i = 1, 2, 3 \quad (18)$$

where

$$\begin{aligned} \tilde{f}_1 &= q_1[1 + q_1^2 + q_2^2 + q_3^2] - q_1^f(1 + q_1^2) \\ &\quad - q_2^f(q_3 + q_1 q_2) + q_3^f(q_2 - q_1 q_3) \\ \tilde{f}_2 &= q_2[1 + q_1^2 + q_2^2 + q_3^2] - q_2^f(1 + q_2^2) \\ &\quad - q_3^f(q_1 + q_2 q_3) + q_1^f(q_3 - q_1 q_2) \\ \tilde{f}_3 &= q_3[1 + q_1^2 + q_2^2 + q_3^2] - q_3^f(1 + q_3^2) \\ &\quad - q_1^f(q_2 + q_1 q_3) + q_2^f(q_1 - q_2 q_3) \end{aligned}$$

Now, motivated by the structure of the globally stabilizing feedback control laws in Eq. (18) and the switching function in Eq. (16) we hypothesize the following set of control laws

$$u_i = -N_i \operatorname{sgn} \left[\tilde{f}_i + \gamma_i \frac{I_i}{2N_i} \omega_i |\omega_i| \right], \quad i = 1, 2, 3 \quad (19)$$

where, N_i is the magnitude of the thruster in the i -th body axis and γ_i is a design parameter. The above control laws do not result in minimum time, however, even when $\gamma_i = 1$. The main objective, with the above control laws, is to extend the previous idea into a general case by introducing a set of design parameters γ_i . Simulation results using the set of control laws are provided in Fig. 2. The desired final attitudes are set to be $[q_1^f, q_2^f, q_3^f] = [0.3, 0.6, -1]$. With increased γ , the performance of the attitude responses are improved significantly. As is evident, the design parameters γ_i

play a significant role in the responses for the nonlinear three axis maneuver.

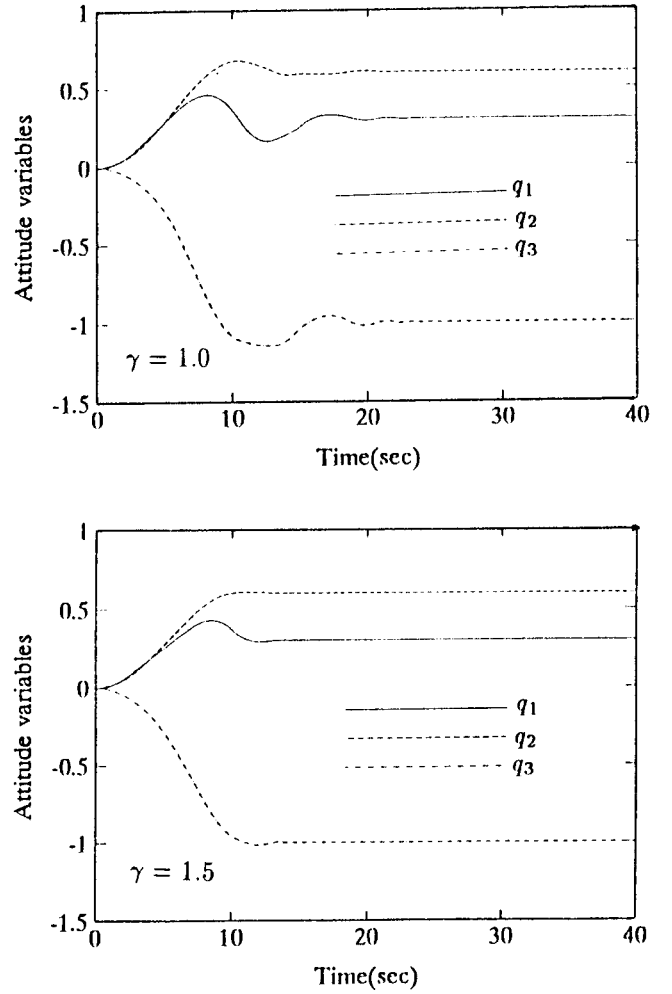

Figure 2 Three axis rigid body maneuver

III. Flexible Space Structure

Next, we extended the application of the proposed switching function to slew maneuvers of flexible spacecraft model. The experimental setup, Flexible Spacecraft Simulator, used for this study is presented in Fig. 3. It simulates pitch axis motion of a spacecraft with a central rigid body and a reflector supported by two astro mast structures. The simulator consists of a central rigid body representing the spacecraft main body, and a flexible appendage representing a reflector with a flexible support structure. The simulator is supported by airpads on a granite table. The central body is allowed to rotate about the vertical axis and is prevented from translational motion by an air bearing. The primary actuators are a reaction wheel and a thruster system on the central body. For this study, however, only the

thruster system is used. The angular position of the central body is determined by a Rotary Variable Differential Transformer (RVDT), and the angular rate by an angular rate sensor. The thruster system is shown in Fig. 4. It consists of a 13.3 cubic foot, 3000 psi supply tank connected to 3000-200 psi pressure regulator. There are two thrusters providing torques in both directions. The system uses 200 psi dry air and the thruster produces 0.3 N-m torque.

The schematic representation of the model is shown in Fig. 5. It consists of a rigid body which is constrained to rotate about a fixed axis and a flexible appendage. The axes $\hat{n}_1, \hat{n}_2, \hat{n}_3$ are inertially fixed and the \hat{n}_3 axis represents the rotational axis. The axes $\hat{b}_1, \hat{b}_2, \hat{b}_3$ are fixed in the body and are obtained from $\hat{n}_1, \hat{n}_2, \hat{n}_3$ by rotation of angle θ about the \hat{n}_3 axis. The elastic deformations of a point on the flexible body are represented by vectors w and are represented by the cantilever modal coordinates as

$$\begin{aligned} w_1(x, t) &= \sum_{i=1}^n \phi_i^1(x) q_i(t) \\ w_2(x, t) &= \sum_{i=1}^n \phi_i^2(x) q_i(t) \end{aligned} \quad (20)$$

where for the i -th mode, $q_i(t)$ is the modal coordinate, ϕ_i^1 is the component of the modal vector along \hat{b}_1 axis and ϕ_i^2 is the component along \hat{b}_2 axis.

The equations of motion for the system are given by

$$\begin{aligned} I_3 \ddot{\theta} + \sum_{i=1}^n D_i \ddot{q}_i &= u \\ \ddot{q}_i + \omega_i^2 q_i + D_i \ddot{\theta} &= 0, \quad i = 1, 2, \dots, n \end{aligned} \quad (21)$$

where I_3 is the moment of inertia of the system about the \hat{b}_3 axis, ω_i is the natural frequency of the i -th mode, u is external torque on the body, including control and disturbance torques, and D_i is rigid-elastic coupling for the i -th mode and is given by

$$D_i = \int_F (x_1 \phi_i^1 - x_2 \phi_i^2) dm \quad (22)$$

where x_1 and x_2 are coordinates of the point along the \hat{b}_1 and \hat{b}_2 axes respectively. A finite element analysis was done to determine structural cantilever frequencies and mode shapes. Table 1 gives natural frequencies for the first six modes which are included in the analysis. The modal damping for all modes is assumed to be 0.4 percent. The control torque u is given by

$$\begin{aligned} u(t) &= -N \operatorname{sgn}[s_\gamma(t)] \\ &= -g_1(t) \ddot{\theta} - g_2(t) \dot{\theta} \end{aligned} \quad (23)$$

where

$$s_\gamma(t) = \left[(\theta - \theta_f) + \gamma \frac{I_r \dot{\theta}}{2N} \right] \quad (24)$$

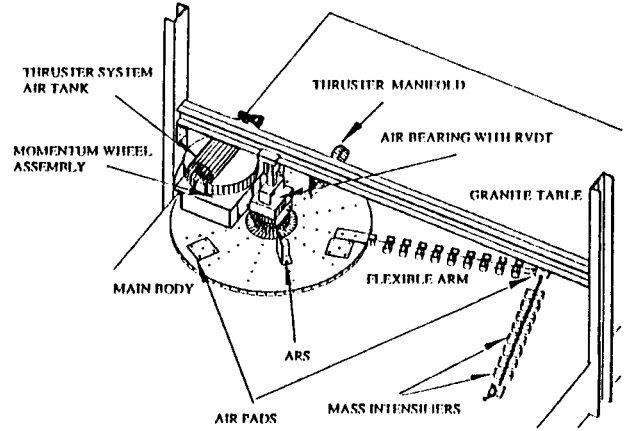

Figure 3 Flexible Spacecraft Simulator

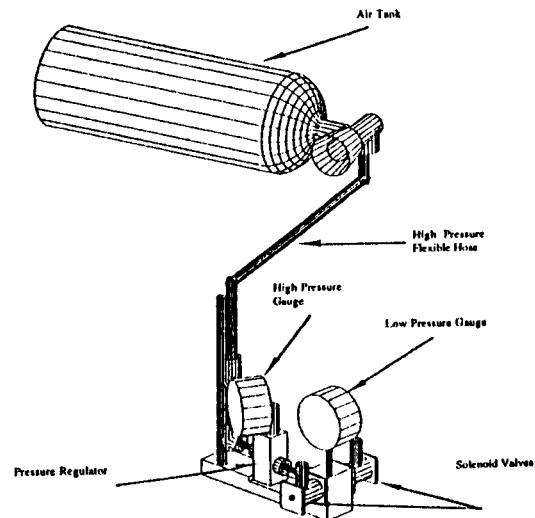

Figure 4 Thruster system configuration

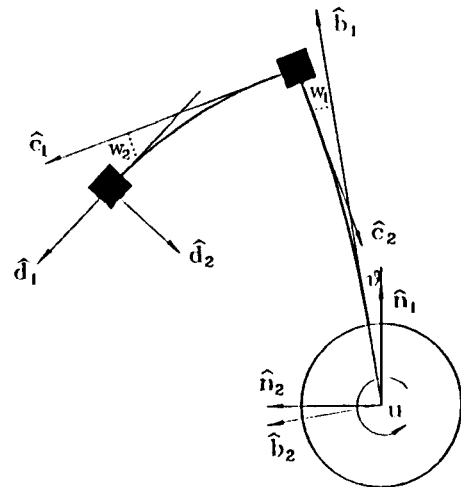

Figure 5 Deformation and sign convention

where I_r is the moment of inertia corresponding to the rigid body motion of the whole structure. The above switching function turned out to produce a close behavior to an open loop approach solution⁵ when γ equal to 1. It has been shown by Junkins and Bang¹² that for the flexible spacecraft configuration, the stability characteristic of the above control law will be the same as for a rigid body. Due to the discontinuous nature of the thruster, the stability is guaranteed within the limitation of the capability of the on-off control action.

Table 1 Natural Frequencies

Mode No.	Frequency(Hz)
1	0.139
2	0.420
3	2.463
4	4.295
5	6.860
6	12.820

IV. Simulation Results

By using the analytical model and the experimental setup, simulations were performed for rest-to-rest slew maneuvers of 50 degrees by using the modified switching control function defined by Eq. (24). A disturbance effect of 6% of control torque magnitude was included in the simulation to create similar environment to the actual experimental set up. Also, in order to prevent unnecessary multiple firings, a deadband around the end of maneuver was used both in the simulation and experiment. Simulations were performed for different values of γ . Figure 6 shows the plot of slew angle, slew angular rate, and thruster firing for analytical simulations with γ equal to 0.8, 1.0, and 1.4. Figure 7 presents the experimental results for the slew angle, angular rate, and thruster firing and strain at the base of flexible structure for γ equal to 0.8, 1.0, and 1.4. As expected, for higher values of $\gamma = 1.4$, the number of firings during the maneuver increases but the overshoot of the slew angle is significantly reduced. For lower value of $\gamma = 0.8$, the number of firing decreases, but the slew angle overshoot increases. The relationship between multiple firings and maneuver performance in these results have a close connection with the open loop approach by Liu and Wie⁸. Also, the strain on the flexible arm was measured by using a piezoceramic sensor. The strain responses are presented in Fig. 8. As expected from

main body response, the strain responses also depend upon the parameter γ . With γ equal to 1.4, the strain level is minimum. Therefore, the parameter γ plays a significant role in the slew maneuver performance.

It should also be noted from the results that significant firings are required to damp out small attitude error and rate near the end of slew maneuver. Therefore, the proposed switching function is not desirable for normal on-orbit control of fine pointing accuracy.

V. Conclusion

The classical switching function provides ideal thruster control of minimum slew maneuver time for a rigid spacecraft with zero modelling errors. For rigid spacecraft with modelling errors and flexible spacecraft, however, the classical switching function will result in multiple thruster firings and pointing errors. The proposed modified switching function provides flexibility of controlling multiple firings and pointing errors in the presence of modelling errors and structural flexibility. The proposed switching function is not desirable for normal on-orbit control of fine pointing accuracy. The proposed control scheme is to use the modified switching function during the slew maneuver and switch to on-orbit control, such as momentum wheel, whenever the attitude error falls within the controllable limit of the on-orbit controllers.

VI. Acknowledgment

The authors would like to express their deepest gratitude to R. Bailey who was responsible for building all the hardware involved. Also, the leading achievement by J. A. Hailey made a significant contribution to this study.

References

1. Turner, J.D., and Junkins, J.L., *Optimal Spacecraft Rotational Maneuvers*, New York, Elsevier Scientific Publishing Co., 1985
2. Wie, B., Weiss, H., and Arapostathis, "Quaternion Feedback Regulator for Spacecraft Eigenaxis Rotations", *Journal of Guidance, Control, and Dynamics*, Vol. 12, No. 3, May-June, 1989, pp. 375-380
3. Byers, R.M., and Vadali, S.R., "Quasi Closed Form Solution to the Time-Optimal Rigid Spacecraft Reorientation Problem", AAS Paper 91-124, AAS/AIAA Spaceflight Mechanics Meeting, Houston, TX, Feb. 11-13, 1991
4. Meier, E.B., and Bryson, A.E., "Efficient Algorithm for Time Optimal Control of a Two-Link Manipulator", *Journal of Guidance, Control, and Dynamics*, Vol. 13, No. 5, 1990, pp. 859-866
5. Singh, G., Kabamba, P.T., McClamroch, N.H., "Planar Time-Optimal, Rest-to-Rest Slewing Ma-

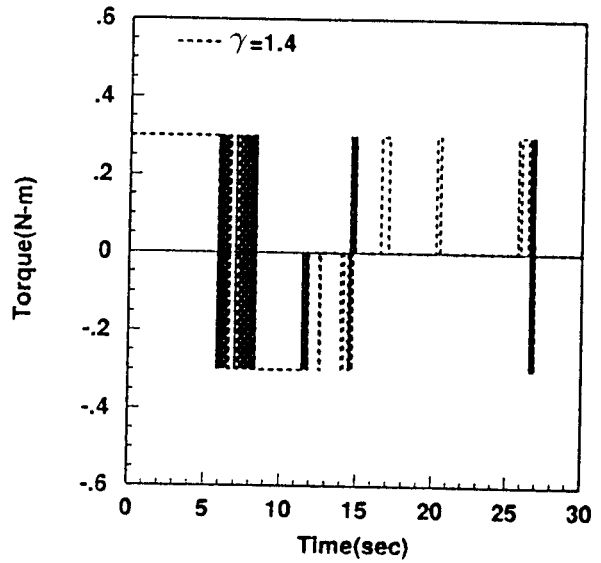
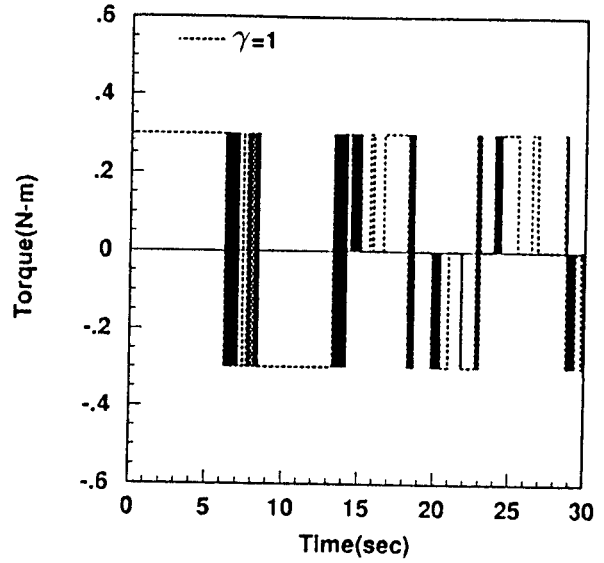
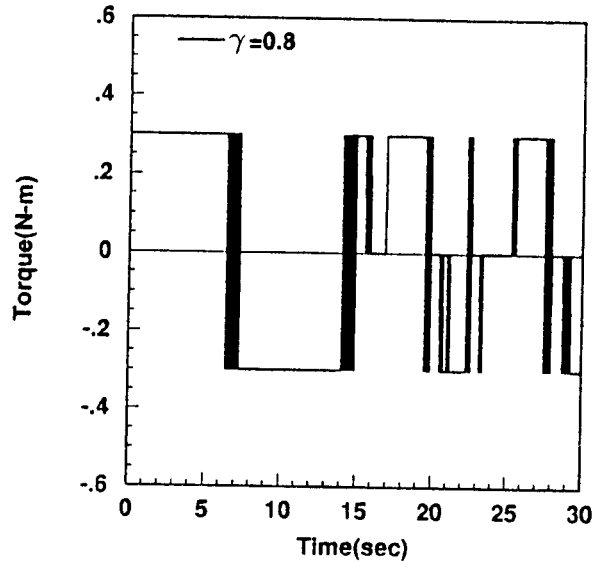
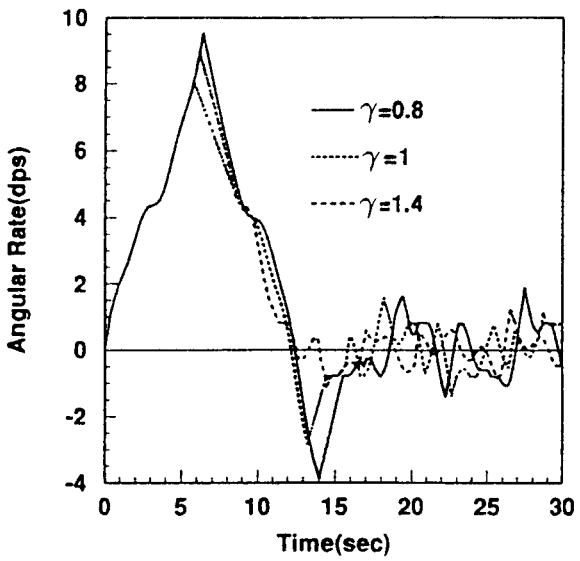
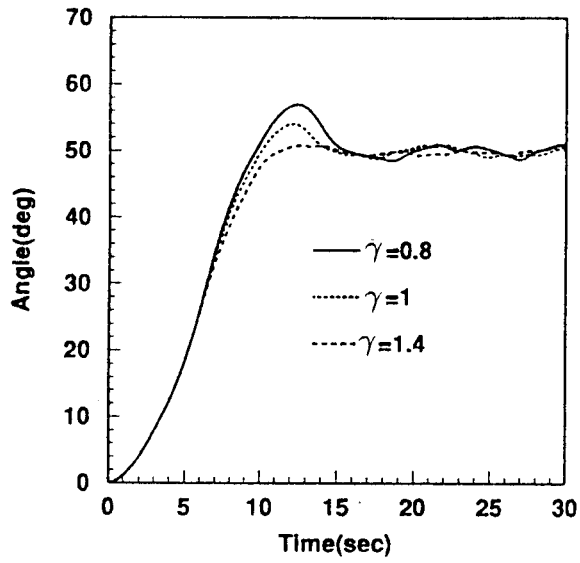

Figure 6 Simulation results for the slew maneuver of Flexible Spacecraft Simulator

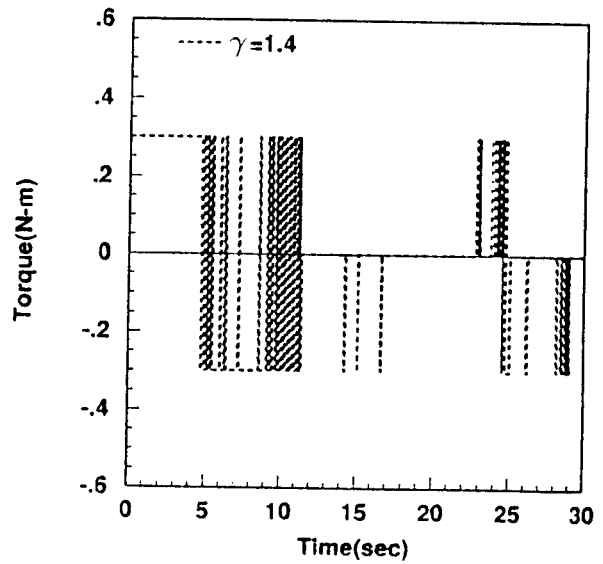
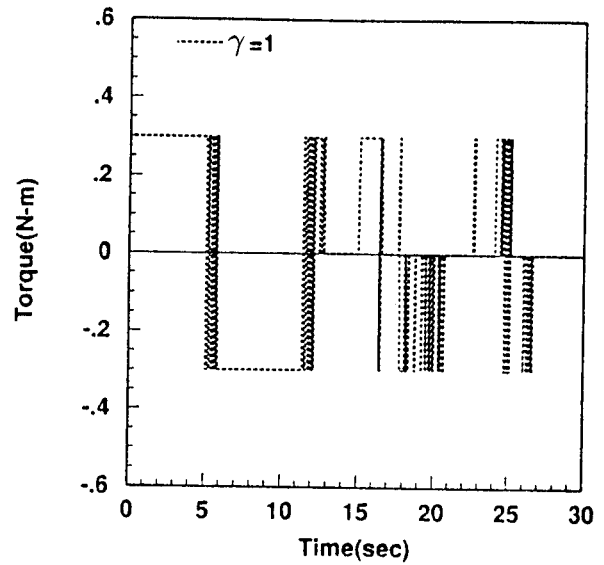
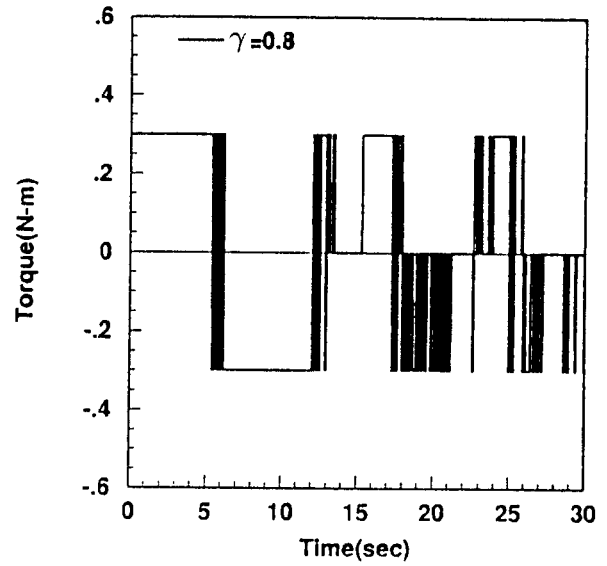
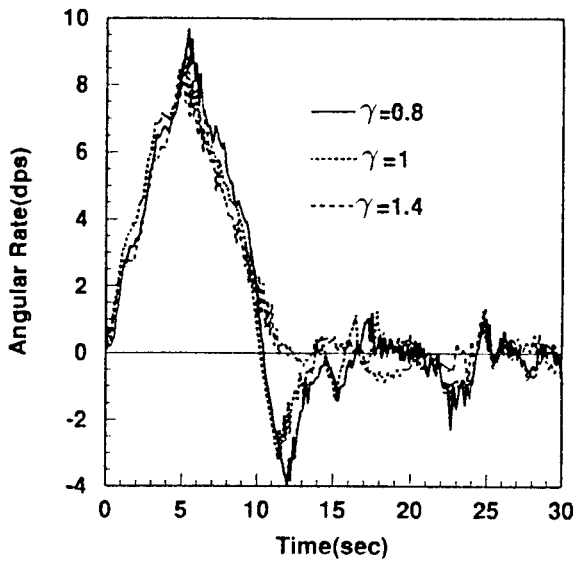
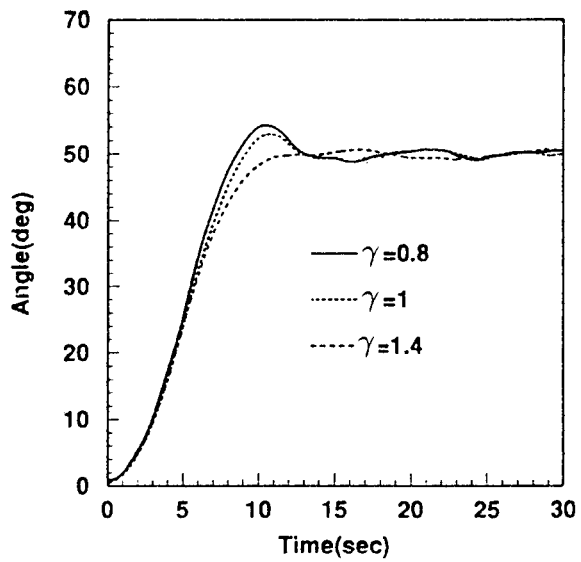

Figure 7 Experimental results for the slow maneuver of Flexible Spacecraft Simulator

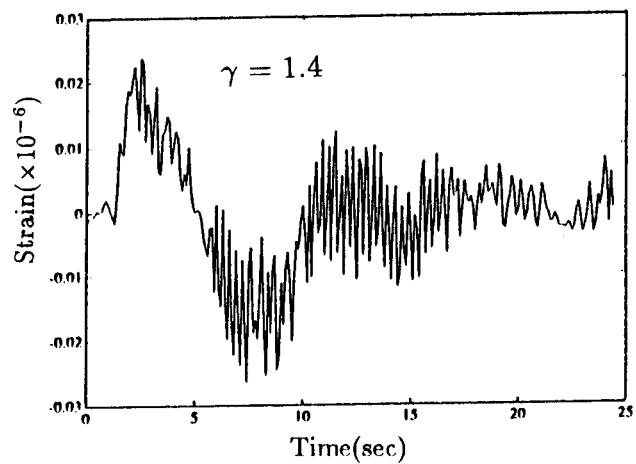
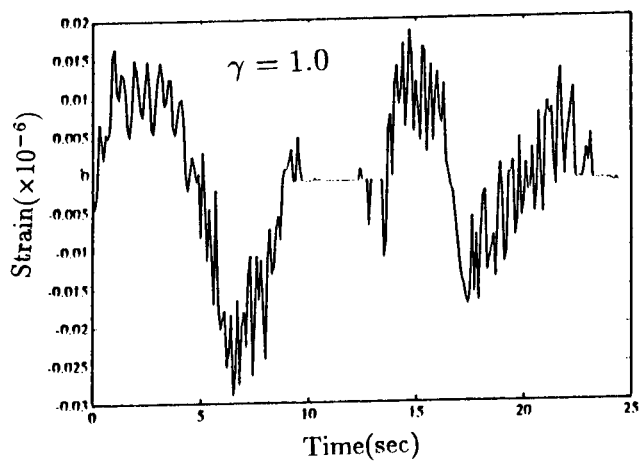
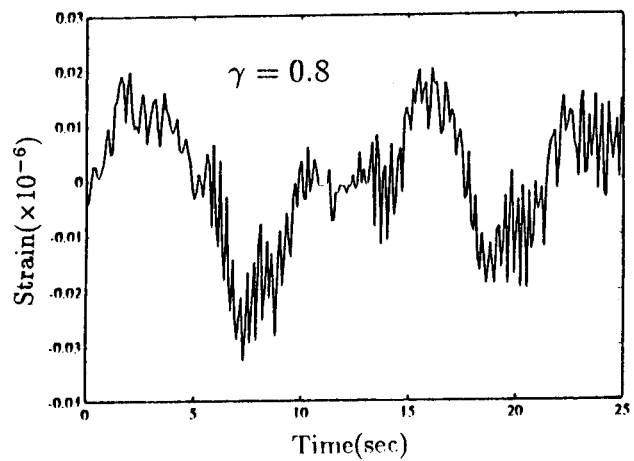

Figure 8 Measured strains during slew maneuver

- neuers of Flexible Spacecraft”, *Journal of Guidance, Control, and Dynamics*, Vol. 12, No.1, 1989, pp. 71-81
6. Vander Velde, W.E., and He, J., “Design of Space Structure Control Systems Using On-Off Thrusters”, *Journal of Guidance, Control, and Dynamics*, Vol. 6, No. 1, 1983, pp.53-60
 7. Hablani, H.B., “Zero-Residual-Energy, Single-Axis Slew of Flexible Spacecraft Using Thrusters: Dynamics Approach”, *Journal of Guidance, Control, and Dynamics*, Vol. 15, No. 1, 1992, pp.104-113
 8. Liu, Q., and Wie, B., “Robust Time-Optimal Control of Uncertain Flexible Spacecraft”, *Journal of Guidance, Control, and Dynamics*, Vol. 15, No. 3, 1992, pp. 597-604
 9. Athans, M., Falb, P.L., *Optimal Control*, McGraw-Hill Book Co., New York, 1966
 10. Pradeep, S., “Stability of Time-Varying Structural Dynamic Systems”, *Mechanics and Control of Large Flexible Structures*, edited by Junkins, J.L., AIAA, Washington, DC, 1990, pp. 349-372
 11. Hailey, J. A., *Experimental Verification of Attitude Control Techniques for Flexible Spacecraft Slew Maneuvers*, Master’s Thesis, Naval Postgraduate School, Monterey, CA, March, 1992
 12. Junkins, J.L., and Bang, H., “Maneuver and Vibration Control of Hybrid Coordinate Systems using Lyapunov Stability Theory”, *Journal of Guidance, Control, and Dynamics*, (to appear)