



Calhoun: The NPS Institutional Archive
DSpace Repository

Theses and Dissertations

1. Thesis and Dissertation Collection, all items

2008-09

The impact analysis of a mixed squadron,
containing LCS and multi-mission surface
platforms, on Blue force casualties and
mission effectiveness

Milliken, Michael S.

Monterey, California. Naval Postgraduate School

<https://hdl.handle.net/10945/3949>

This publication is a work of the U.S. Government as defined in Title 17, United States Code, Section 101. Copyright protection is not available for this work in the United States.

Downloaded from NPS Archive: Calhoun



Calhoun is the Naval Postgraduate School's public access digital repository for research materials and institutional publications created by the NPS community. Calhoun is named for Professor of Mathematics Guy K. Calhoun, NPS's first appointed -- and published -- scholarly author.

Dudley Knox Library / Naval Postgraduate School
411 Dyer Road / 1 University Circle
Monterey, California USA 93943

<http://www.nps.edu/library>



**NAVAL
POSTGRADUATE
SCHOOL**

MONTEREY, CALIFORNIA

THESIS

**THE IMPACT ANALYSIS OF A MIXED SQUADRON,
CONTAINING LCS AND MULTI-MISSION SURFACE
PLATFORMS, ON BLUE FORCE CASUALTIES AND
MISSION EFFECTIVENESS**

by

Michael S. Milliken

September 2008

Thesis Advisor:
Second Reader:

Thomas W. Lucas
Edward J. Lesnowicz Jr.

This thesis was done in cooperation with the MOVES Institute

Approved for public release; distribution is unlimited

THIS PAGE INTENTIONALLY LEFT BLANK

REPORT DOCUMENTATION PAGE			<i>Form Approved OMB No. 0704-0188</i>
Public reporting burden for this collection of information is estimated to average 1 hour per response, including the time for reviewing instruction, searching existing data sources, gathering and maintaining the data needed, and completing and reviewing the collection of information. Send comments regarding this burden estimate or any other aspect of this collection of information, including suggestions for reducing this burden, to Washington headquarters Services, Directorate for Information Operations and Reports, 1215 Jefferson Davis Highway, Suite 1204, Arlington, VA 22202-4302, and to the Office of Management and Budget, Paperwork Reduction Project (0704-0188) Washington DC 20503.			
1. AGENCY USE ONLY (Leave blank)	2. REPORT DATE September 2008	3. REPORT TYPE AND DATES COVERED Master's Thesis	
4. TITLE AND SUBTITLE The Impact Analysis of a Mixed Squadron, Containing LCS and Multi-Mission Surface Platforms, on Blue Force Casualties and Mission Effectiveness		5. FUNDING NUMBERS	
6. AUTHOR(S) Michael S. Milliken		8. PERFORMING ORGANIZATION REPORT NUMBER	
7. PERFORMING ORGANIZATION NAME(S) AND ADDRESS(ES) Naval Postgraduate School Monterey, CA 93943-5000		10. SPONSORING/MONITORING AGENCY REPORT NUMBER	
9. SPONSORING /MONITORING AGENCY NAME(S) AND ADDRESS(ES) N/A		11. SUPPLEMENTARY NOTES The views expressed in this thesis are those of the author and do not reflect the official policy or position of the Department of Defense or the U.S. Government.	
12a. DISTRIBUTION / AVAILABILITY STATEMENT Approved for public release; distribution is unlimited		12b. DISTRIBUTION CODE A	
13. ABSTRACT (maximum 200 words) In today's world, the United States is the dominant naval power. World powers are trading naval dominance in favor of naval defense, creating fleets of smaller ships to protect their littoral waters. As a result, the United States Navy will be called upon to engage enemy naval forces to ensure access against asymmetrical threats close to enemy coastlines. The Littoral Combat Ship (LCS) is a networked, focused-mission platform, designed to be swift, agile, stealthy, and capable of defeating asymmetric threats in the littorals. Although the LCS has limited capability to handle simultaneous missions, it will not be alone. The experimental guided missile destroyer DD(X) represents the U.S. Navy's next-generation. It is a multi-mission, surface combatant tailored for land attack and littoral dominance, with capabilities designed to defeat current and projected threats. Through simulation, data analysis and design of experiment, this analysis simulated 15,420 littoral battles to determine if the addition of a multi-mission platform to an LCS squadron affects overall Blue force casualties and mission effectiveness. The study examined squadron composition, size, and effects of sensors and weapon systems in both a Surface Warfare (SUW) and Anti-Air Warfare (AAW) scenario. The data analysis revealed that a squadron composition of 5 to 11 LCSs with 1 to 2 DDGs in a stressing SUW scenario provided the best outcomes, while Destroyers and aircraft had the most impact for AAW missions.			
14. SUBJECT TERMS LCS, DD(X), DDG-1000, Zumwalt, Littoral, MANA, Asymmetric, Coastlines, Squadron, DDG, Simulation, Design of Experiments, SUW, AAW.			15. NUMBER OF PAGES 123
			16. PRICE CODE
17. SECURITY CLASSIFICATION OF REPORT Unclassified	18. SECURITY CLASSIFICATION OF THIS PAGE Unclassified	19. SECURITY CLASSIFICATION OF ABSTRACT Unclassified	20. LIMITATION OF ABSTRACT UU

NSN 7540-01-280-5500

Standard Form 298 (Rev. 2-89)
Prescribed by ANSI Std. Z39-18

THIS PAGE INTENTIONALLY LEFT BLANK

Approved for public release; distribution is unlimited

**THE IMPACT ANALYSIS OF A MIXED SQUADRON, CONTAINING LCS AND
MULTI-MISSION SURFACE PLATFORMS, ON BLUE FORCE CASUALTIES
AND MISSION EFFECTIVENESS**

Michael S. Milliken
Lieutenant Commander, United States Navy
B.S., University of Iowa, 1997
M.S., Central Michigan University, 2004

Submitted in partial fulfillment of the
requirements for the degree of

**MASTER OF SCIENCE IN
MODELING, VIRTUAL ENVIRONMENTS, AND SIMULATION (MOVES)**

from the

**NAVAL POSTGRADUATE SCHOOL
September 2008**

Author: Michael S. Milliken

Approved by: Thomas W. Lucas
Thesis Advisor

Edward J. Lesnowicz, Jr.
Second Reader

Mathias Kölsch
Chair, MOVES Academic Committee

THIS PAGE INTENTIONALLY LEFT BLANK

ABSTRACT

In today's world, the United States is the dominant naval power. World powers are trading naval dominance in favor of naval defense, creating fleets of smaller ships to protect their littoral waters. As a result, the United States Navy will be called upon to engage enemy naval forces to ensure access against asymmetrical threats close to enemy coastlines.

The Littoral Combat Ship (LCS) is a networked, focused-mission platform, designed to be swift, agile, stealthy, and capable of defeating asymmetric threats in the littorals. Although the LCS has limited capability to handle simultaneous missions, it will not be alone. The experimental guided missile destroyer DD(X) is the U.S. Navy's next-generation; multimission, surface combatant tailored for land attack and littoral dominance, with capabilities designed to defeat current and projected threats.

Through simulation, data analysis and design of experiment, this model simulated 15,420 littoral battles to determine if the addition of a multimission platform to an LCS squadron affected overall Blue force casualties and mission effectiveness. The study examined squadron composition, size, and effects of sensors and weapon systems in both a Surface Warfare (SUW) and Anti-Air Warfare (AAW) scenario. The data analysis revealed that a squadron composition of 5 to 11 LCSs with 1 to 2 DDGs in an SUW scenario provided the best outcomes, while Destroyers and aircraft had the most impact for AAW missions.

THIS PAGE INTENTIONALLY LEFT BLANK

THESIS DISCLAIMER

The reader is cautioned that the computer programs presented in this research may not have been exercised for all cases of interest. While every effort has been made, within the time available, to ensure that the programs are free of computational and logical errors, they cannot be considered validated. Any application of these programs without additional verification is at the risk of the user.

THIS PAGE INTENTIONALLY LEFT BLANK

TABLE OF CONTENTS

I.	INTRODUCTION.....	1
	A. OVERVIEW	1
	B. BACKGROUND AND MOTIVATION	2
	C. RESEARCH QUESTIONS	3
	D. BENEFITS OF THE STUDY	3
	E. METHODOLOGY	4
II.	MODEL DEVELOPMENT	7
	A. INTRODUCTION.....	7
	B. LITTORAL COMBAT SHIP (LCS) DESIGN	7
	1. Overview	7
	2. Seaframe	8
	3. Mission Packages	10
	a. Surface Warfare (SUW).....	10
	b. Antisubmarine Warfare (ASW).....	11
	4. Additional Capabilities.....	12
	C. DDG-1000 DESIGN.....	12
	1. Overview	12
	2. Capabilities	13
	D. DESCRIPTION OF SCENARIOS.....	15
	1. SUW Scenario.....	15
	a. Enemy	16
	b. Friendly	16
	c. Mission	17
	2. AAW Scenario.....	17
	a. Enemy	18
	b. Friendly	18
	c. Mission	19
	E. MAP AWARE NON-UNIFORM AUTOMATA (MANA) SIMULATION MODEL	19
	1. The Decision to Use MANA	20
	F. CHARACTERISTICS OF MANA.....	21
	1. Simulation Goal.....	22
	2. Terrain and Scale.....	22
	3. Enemy Forces	24
	4. Friendly Forces.....	24
	5. Sources, Abstractions, and Assumptions	25
	6. Summary.....	27
III.	DESIGN OF EXPERIMENT.....	29
	A. INTRODUCTION.....	29
	B. MODEL ASSUMPTIONS.....	29
	1. Controllable Factors	31

a.	<i>SUW LCS</i>	31
b.	<i>ASW LCS</i>	31
c.	<i>DDG-1000</i>	31
d.	<i>SUW MH-60R Probability of Detection (Pd)</i>	31
e.	<i>ASW MH-60R Pd</i>	32
f.	<i>DDG Pd</i>	32
g.	<i>LCS Pd</i>	32
h.	<i>ASW USV Pd</i>	32
i.	<i>NLOS Probability of Kill (Pk)</i>	32
j.	<i>57mm Pk</i>	32
k.	<i>30mm Pk</i>	33
l.	<i>RAM Pk</i>	33
m.	<i>.50 Caliber Pk</i>	33
n.	<i>Blue Torpedo Pk</i>	33
o.	<i>Hellfire Pk</i>	33
p.	<i>155mm Pk</i>	33
q.	<i>Standard Missile Pk</i>	34
2.	Uncontrollable Factors	34
a.	<i>Missile boats</i>	34
b.	<i>Submarines</i>	34
c.	<i>Aircraft</i>	34
d.	<i>Merchants</i>	35
C.	EXPERIMENT DESIGN	35
1.	Exploratory Design	35
2.	Preliminary Design	36
3.	Full Design	36
4.	The Nearly Orthogonal Latin Hypercube (NOLH)	37
D.	MODEL EXECUTION	38
IV.	DATA ANALYSIS	41
A.	INTRODUCTION	41
B.	PROCESSING THE DATA	41
C.	RESEARCH QUESTIONS AND CONCERNS	42
1.	Impact of the Addition of Multimission Platforms on LCS Squadron Size	42
a.	<i>SUW Scenario</i>	42
b.	<i>AAW Scenario</i>	49
c.	<i>Summary</i>	54
2.	The Effectiveness of Blue Force Self-Defense Weapon Systems	54
a.	<i>SUW Scenario</i>	55
b.	<i>AAW Scenario</i>	59
c.	<i>Summary</i>	62
D.	FURTHER INSIGHTS	62
1.	LCS Squadron Force Reduction in the SUW Scenario	62
2.	The Advantages of Multimission Platforms in an LCS Squadron	63

3.	Limitations of the Littoral Combat Ship (LCS)	63
V.	CONCLUSIONS AND RECOMMENDATIONS	65
A.	SUMMARY OF FINDINGS	65
B.	QUESTIONS ADDRESSED IN THIS STUDY	65
C.	FURTHER INSIGHTS FROM THE DATA	67
1.	Significance of Early Detection and Force Communication	68
2.	Limitations on the AAW Mission for LCS	68
3.	The Benefit of Simulating Operations Using MANA	68
4.	The Importance of Filtered Data for Analysis	69
D.	TOPICS FOR FURTHER STUDY	70
APPENDIX A.	PERSONALITIES AND CAPABILITIES OF MANA	
AGENTS	73
APPENDIX B.	EXPERIMENTAL DESIGNS	79
APPENDIX C.	GRAPHS AND CHARTS	83
	LIST OF REFERENCES	93
	INITIAL DISTRIBUTION LIST	95

THIS PAGE INTENTIONALLY LEFT BLANK

LIST OF FIGURES

Figure 1.	Composition of a mission package (From: Taylor, 2008).....	8
Figure 2.	Lockheed Martin Team LCS Design (From: Program Executive Office Ships, 2008).	9
Figure 3.	General Dynamics-Bath Iron Works LCS Design (From: Program Executive Office Ships, 2008).	9
Figure 4.	DDG-1000 Ship Design and Characteristics (From: Northrop Grumman Shipbuilding, 2008).	13
Figure 5.	Artist Impression of DDG-1000 in combat. (From: Northrop Grumman Shipbuilding, 2008).	15
Figure 6.	Screen shot of SUW Scenario from MANA.....	17
Figure 7.	Screen shot of AAW Scenario from MANA.	19
Figure 8.	Screen shot of MANA start-up screen. Website contains more reference material (From: MANA 2007).....	20
Figure 9.	Terrain (left) and Background (right) maps used in both scenarios. The gray lining the land on the terrain map is the wall feature and the dark gray covering the peninsula is the hilltop feature (From: Abbott 2008).....	23
Figure 10.	Scatter plot matrix of the variables in the SUW scenario illustrates the orthogonality and space-filling properties of the NOLH. Labels on the diagonal are the names of the variables.	38
Figure 11.	Regression analysis of Mean Total Blue Casualties for the SUW scenario.	43
Figure 12.	Left side of the regression tree for Mean Total Blue Casualties, where there are less than 25 Red missile boats.....	44
Figure 13.	Right side of the regression tree for Mean Total Blue Casualties, where there are greater than 25 Red missile boats.	45
Figure 14.	Graphs of Mean Total Blue Casualties and Mean Total Red Casualties vs. Number of LCSs shows the impact of an employable LCS squadron with 5 to 11 LCSs.....	47
Figure 15.	Graph of Mean Total Blue Casualties, Mean Total Red Casualties, and Mean Total LCS Casualties shows the contribution that a DDG has on an LCS squadron.....	47
Figure 16.	Graph of Mean Total Blue Casualties, Mean Total Red Casualties, and Mean Total LCS Casualties vs. number of DDGs shows the significant contribution made by the DDG in this scenario.....	48
Figure 17.	Regression analysis of Mean Total Blue Casualties for the AAW scenario.	50
Figure 18.	Portion of regression tree for Mean Total Blue Casualties for the AAW scenario.	51
Figure 19.	Portion of regression tree for Mean Total Blue Casualties for the AAW scenario.	52
Figure 20.	Graphs of Mean Total Blue Casualties and Mean Total LCS Casualties vs. Red Aircraft.	53
Figure 21.	Graphs of Mean Total Blue Casualties, Mean Total Red Casualties, and Mean Total Red Aircraft Casualties vs. DDG.	53

Figure 22.	Regression analysis of Mean Total Blue Casualties and Mean Total LCS Casualties when considering only sensors and weapon systems for the SUW scenario.	56
Figure 23.	Regression analysis resulting from effects screening of Mean Total Blue Casualties in the SUW scenario, when considering only sensors and weapon systems.	58
Figure 24.	Regression analysis of Mean Total Blue Casualties and Mean Total Red Casualties, when considering only sensors and weapon systems for the AAW scenario.....	59
Figure 25.	Regression analysis resulting from effects screening of Mean Total Blue Casualties and Mean Total Red Casualties, when considering only sensors and weapon systems for the AAW scenario.	60
Figure 26.	Regression analysis resulting from effects screening of Mean Total Red Casualties, when considering only sensors and weapon systems for the AAW scenario.....	61

LIST OF TABLES

Table 1.	Sensors and weapons for the LCS seaframe (From: Naval Warfare Development Command, 2007).....	9
Table 2.	Systems and weapons contained in the SUW mission package (From: Naval Warfare Development Command, 2007).	10
Table 3.	Systems and weapons contained in the ASW mission package (From: Naval Warfare Development Command, 2007).	11
Table 4.	Variable factors used in the experiment design. Modeled Factors are in grey, and noise factors are in white.	30

THIS PAGE INTENTIONALLY LEFT BLANK

LIST OF KEYWORDS, SYMBOLS, ACRONYMS, AND ABBREVIATIONS

AA	Air to Air
AAW	Anti-Air Warfare
ABD	Agent-Based Distillations
AGS	Advanced Gun System
ALFS	Airborne Low Frequency Sonar
ASM	Anti-Ship Missile
ASW	Antisubmarine Warfare
ASuW	Anti-Surface Warfare
C4I	Command, Control, Communications, Computers and Intelligence
C4ISR	Command, Control, Communications, and Computers, Intelligence, Surveillance and Reconnaissance
CA	Cellular Automaton
CAS	Complex Adaptive Systems
CG(X)	Experimental Guided Missile Cruiser
CIGS	Close-In Gun System
CNO	Chief of Naval Operations
CNSF	Commander Naval Surface Forces
CONOPS	Concept of Operations
CSG	Carrier Strike Group
CSV	Comma Separated Value
DDG	Guide Missile Destroyer
DD(X)	Experimental Guided Missile Destroyer
DTA	Defence Technology Agency (New Zealand)
DTRA	Defense Threat Reduction Agency
EO	Electro-Optical
EOD	Explosive Ordnance Disposal
ERGM	Extended Range Guided Munition
ESG	Expeditionary Strike Group
ESSM	Enhanced Sea Sparrow Missile
GD	General Dynamics
IR	Infrared
JFC	Joint Force Commander
LCS	Littoral Combat Ship
LM	Lockheed Martin
LRLAP	Long Range Land Attack Projectile
MANA	Map Aware Non-uniform Automata
MFR	Multifunction Radar
MFTA	Multifunction Towed Array
MIO	Maritime Interdiction Operations
MIW	Mine Warfare

MOE	Measure of Effectiveness
MOVES	Modeling Of Virtual Environments and Simulation
NLOS	Non-Line of Sight
NLOS-LS	Non-Line of Sight Launch System
NM	Nautical Mile
NOLH	Nearly Orthogonal Latin Hypercube
NPS	Naval Postgraduate School
NumLCS	Number of Littoral Combat Ships
OTH	Over-The-Horizon
Pd	Probability of Detection
PGGF	Fast Attack Craft – Missile
PIM	Plan of Intended Movement
Pk	Probability of Kill
PVLS	Peripheral Vertical Launch System
RAM	Rolling Airframe Missile
RIM	Radar Intercept Missile
RMS	Remote Minehunting System
RMV	Remote Minehunting Vehicle
RTA	Remote Towed Array
RTAS	Remote Towed Active Source
SAM	Surface to Air Missile
SAG	Surface Action Group
SEED	Simulation Experiments and Efficient Designs
SM	Standard Missile
SSM	Surface to Surface Missile
SSTR	Stability, Security, Transition and Reconstruction
SUCAP	Surface Combat Air Patrol
SUW	Surface Warfare
TLAM	Tomahawk Land Attack Missile
TTP	Tactics, Techniques, and Procedures
UAV	Unmanned Aerial Vehicle
UDS	Unmanned Dipping Sonar
UN	United Nations
USV	Unmanned Surface Vehicle
USW	Undersea Warfare
UTS	Unmanned Towed System
UTAS	Unmanned Towed Array System
VLS	Vertical Launch System
VSR	Volume Search Radar
VTUAV	Vertical Takeoff Unmanned Aerial Vehicle
XML	eXtensible Markup Language

ACKNOWLEDGMENTS

There are many people I wish to thank for their contributions and support in making this research project possible. But first, I need to take this opportunity to thank my wife Amy and our four children, Andrew, Annika, Caitlyn, and our latest addition, Sean, for their support and patience, which allowed me to complete this program within the time allotted. Amy, you played an important role in helping me with my studies where it mattered. I am very fortunate to have a strong and supportive family and I want to thank them for all the support they gave me.

I want to thank Professor Curtis Blais of the MOVES Institute for getting me interested in using MANA in the first place. I also want to thank Professor Tom Lucas of the Operations Research Department, who really captured my interest in doing combat and tactical analysis. I had the pleasure to take his Introduction to Combat Modeling course, where everything began to come together. He subsequently became my thesis advisor—a decision I do not regret. His knowledge and guidance have been instrumental in making this research possible. I would also like to thank LT Ben Abbott, whose work is continued through this research. Ben was very helpful and supportive of my research. He guided me and pointed out potential pitfalls before they turned into an abyss.

I also want to thank the SEED Center folks, Debbie Sandoval, Professor Paul Sanchez and Colonel Ed Lesnowicz, USMC (Ret.) for their help and support along the way and for providing a place to do quality work. I also want to give a big thanks and my sincerest appreciation to Mary McDonald, Research Assistant for the SEED Center. Her continuous and timely feedback and analytical support made this research possible. To her, much credit is duly justified—I thank you very much for your humble guidance and outstanding support.

THIS PAGE INTENTIONALLY LEFT BLANK

EXECUTIVE SUMMARY

This study analyzes the impact of a mixed squadron, containing a Littoral Combat Ship (LCS) squadron and multimission surface platforms, on Blue force casualties and mission effectiveness. This summary provides an overview of both the LCS and the Zumwalt Class Destroyer (DDG-1000), which was chosen as the multimission platform. It also describes the research methodology, conclusions, and recommendations. The goal of this study is to analyze and determine the right mix of LCS ships and traditional multimission naval warships in a coastal littoral environment without sacrificing mission capability.

Developed under the DD(X) destroyer program, USS Zumwalt (DDG-1000) is the lead ship in a class of next-generation, multimission surface vessels tailored for land attack and littoral dominance, with capabilities designed to defeat current and projected threats and carry out traditional destroyer missions of Anti-Air Warfare (AAW), Surface Warfare (SUW), and Undersea Warfare (USW). This advanced multimission destroyer will bring revolutionary improvements to precise, time-critical strike and joint fires for our Expeditionary and Carrier Strike Groups of the future. It expands the battlespace by over 400%; has the radar cross section of a fishing boat; and is as quiet as a Los Angeles Class submarine. DDG-1000 will also enable the transformation of our operations ashore. Its on-demand, persistent, time-critical strike capability revolutionizes our joint fire support and ground maneuver concepts of operation, so that our strike fighter aircraft are freed for more difficult targets at greater ranges. DDG-1000 will provide a credible forward presence, while operating independently or as an integral part of naval, joint, or combined expeditionary forces.

The LCS, starting with the USS Freedom (LCS-1), are a new class of fast, agile, and networked warships designed to overcome threats in shallow waters, and are key components in a proposed family of next-generation surface vessels that also includes the much larger DDG-1000 destroyer and the future experimental guided missile cruiser CG(X). LCSs will be able to deploy independently to littoral regions throughout the

world; remain on station for extended periods of time, either with a Carrier Strike Group (CSG) or an Expeditionary Strike Group (ESG), or through a forward-basing arrangement; operate independently or with an LCS squadron. When deploying an LCS as part of a squadron, a Combatant Commander may decide to equip multiple LCS platforms with a mix of focused-mission packages to ensure operational success across the broad range of challenges associated with littoral warfare.

The objective of the LCS concept of operations is to allow the United States Navy to reduce the shipboard manning requirements and maximize asset allocation for the rest of the surface force. The LCS will incorporate advanced technologies, employing cost-optimized advanced weapons; sensors; data fusion; command, control, communications, computers, intelligence, surveillance, and reconnaissance (C4ISR) systems; hull forms; propulsion systems; manning concepts; smart control systems; and self-defense systems.

The goal of this study is to analyze and determine the right mix of LCS ships and traditional multimission naval warships in a coastal littoral environment without sacrificing mission capability. The guiding questions are:

- How many LCSs should there be in a squadron, when adding multimission warships?
- What is the impact of reducing an LCS squadron containing traditional multimission platforms in an environment that may contain multiple threats?
- How effective are the force self-defense weapon systems, with regard to enabling completion of the focused mission?

This study uses simulation, data analysis, and other techniques to investigate these questions and develop a methodology to determine the best configuration of an LCS squadron for a given region, based on the threats that may exist. The approach to these questions was to create two scenarios based on LCS and DDG capabilities: SUW and AAW. In each of these scenarios, a secondary or tertiary threat is included. That other threat is from submarines, allowing some exploration of the Antisubmarine Warfare (ASW) capabilities of the LCS ASW mission package. Each scenario's mission is the

same: render the current mission threat neutralized. For the SUW scenario, the combined squadron of LCS/DDG will face a combined force of a missile boat and submarine threat. For the AAW scenario, the squadron will face a primary threat from the air and secondary threat from the surface, with hostile submarines operating in the area. The intent of this scenario is to capture the multimission capabilities inherent in the DDG.

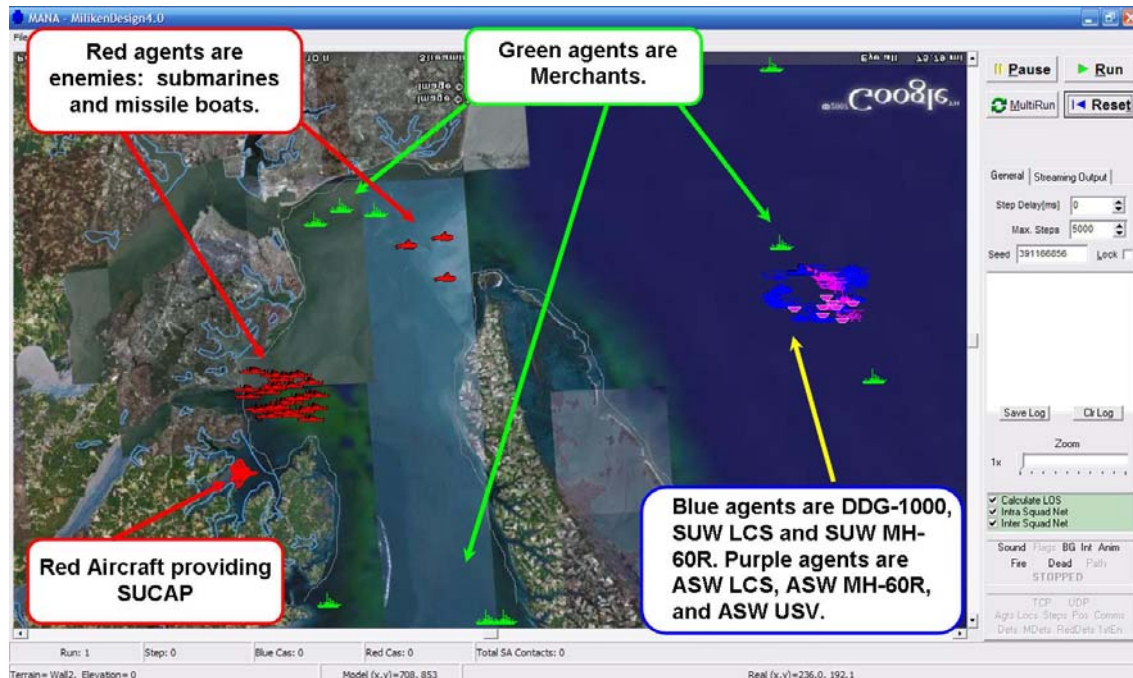

Figure ES-1. Screen Shot of the AAW Scenario in MANA.

The simulation used to model these scenarios is an agent-based combat modeling tool called Map Aware Non-uniform Automata (MANA). MANA is a combat model developed and given to NPS by New Zealand's Defence Technology Agency (DTA); it is user friendly with a quick learning curve, enabling the modeler to perform excellent, quick turn around experiments. MANA allows the user to create numerous scenarios and models. Agent-based personalities that apply to sensors, weapons, and other parameters are easily manipulated in MANA which also lends itself to data farming.

This modeling tool allows numerous variables (i.e., number of ships, planes, submarines, probabilities of kill and detection for sensors and weapon systems) to be

analyzed over broad ranges, providing insight into a large number of possible outcomes. In order to capture as much of the input space as possible, these factors are varied through a Nearly Orthogonal Latin Hypercube (NOLH), creating 257 different situations for each scenario. These runs were replicated 30 times each, resulting in 7,710 separate scenarios, with a total of 15,420 simulated battles. These simulated operations were conducted in minimum time and setup, and would have been costly if conducted in real life.

An analysis of the simulation results generated by this study was conducted, the results of this research supports the following general recommendations:

In order to produce low mean Blue casualties and high Red casualties against a simulated threat environment in this study, the following composition is recommended for SUW missions:

- Three to four SUW LCSs, 2 to 3 ASW LCSs, and one DDG. At least one ASW LCS should always accompany an LCS squadron as a safeguard against unknown submarine threats.

When deploying an employed LCS squadron for an SUW mission that may include an AAW threat, the following composition is recommended:

- Five to seven SUW LCSs, 1 to 2 ASW LCSs, and 1 to 3 DDGs.

In the absence of reliable intelligence the following composition is recommended:

- Five SUW LCSs, one ASW LCS, and two DDGs. This allows for overlapping of capabilities without compromising the force. This would also apply when situations may contain a credible submarine threat.

With regard to the effects of sensors and weapon systems, the analysis reveals the following:

- The number of missile boats and SUW LCSs are more significant than sensors and weapon systems in the SUW scenario.
- 155mm Probability of Kill (Pk), SM-2 Pk, 57mm Pk, Hellfire Pk, Torp Pk, ASW Helo Probability of Detection (Pd), ASW O Pd, and Non-Line of Sight (NLOS) Pk significantly contribute to the Measures of Effectiveness

(MOEs) in the AAW scenario. Weapons and sensors that had interactions with one another in the analysis were also significant.

Upon completion of the simulation experiments and data analysis, the results of this study support the following recommendation for the two scenarios modeled:

- In order to produce low mean Blue casualties and high Red casualties, it is recommended the employed LCS squadron consist of 5 to 11 LCSs, with 1 to 2 DDGs. DDGs provide overlapping capabilities and a creditable AAW deterrent.
- When deploying an LCS squadron for an SUW mission, it is recommended that the force consist of 3 to 4 SUW LCSs, 2 to 3 ASW LCSs, and one DDG. At least one ASW LCS should always accompany an LCS squadron as a safeguard against unknown submarine threats.
- When deploying an employed LCS squadron for an SUW mission that may include an AAW threat, the following composition is recommended: 5 to 7 SUW LCSs, 1 to 2 ASW LCSs, and 1 to 3 DDGs.
- In situations where enemy force disposition is uncertain, the recommended compositional “rule of thumb” is five SUW LCSs, one ASW LCS, and two DDGs. This allows for overlapping of capabilities without compromising the force. This would also apply when situations may contain a credible submarine threat.
- The use of simulation and experimentation helped provide valuable information that was timely and insightful for platforms not yet certified for combat. It is recommended that these techniques be used in future Navy research to guide the development and deployment of new technologies.
- The benefits of using an adaptable, yet easy to learn, simulation tool like MANA cannot be overemphasized. The use of MANA for this research allowed for quick turn around results, which under normal conditions and with the use of more robust simulation tools, would have taken months instead of days or weeks. Tools such as this give commanders insight that is sufficient to make decisions in a timely manner.

This research provides insightful and analytic support for the size and composition of an LCS squadron supported by multimission combatants, such as the DDG, and identifies the significant sensors and weapon systems needed for each warfare area reviewed. The end product is information that can be used by decision makers in

developing policies, Concepts of Operation (CONOPS), and Tactics, Techniques, and Procedures (TTPs) for their deployed forces.

I. INTRODUCTION

Who Commands Sea -- Commands Trade

Fleet Admiral Chester W. Nimitz, USN
on day of departure from the Navy Department as Chief of Naval Operations (CNO)

A. OVERVIEW

In today's world, naval threats have changed; blue ocean fleet engagements have given way to more littoral operations. This leaves naval assets at risk in coastal regions, and vulnerable to coastal missile launchers on land. The big concerns are the bombing of the USS Cole in Yemen, modern-day pirates on the open seas, and small boat swarms. As a result, sea lanes are at greater risk, impacting world trade. Rogue nations are imposing their political and military agendas, creating uneasy and tenuous conditions in these regions. Lastly, the United States is engaged in a protracted global war on terror. What capability that is needed is the right mix of assets and technology. The introduction of new platforms like the Littoral Combat Ship (LCS), the destroyer DD(X), and others are paving the way. New Tactics, Techniques, and Procedures (TTPs) and Concepts of Operations (CONOPS) are needed to ensure these new platforms are effectively and safely used. Other related mission areas affected are Maritime Interception Operations (MIO), involving high-seas piracy; escort operations such as Operation Ernest Will, where the United States Navy escorted reflagged Kuwaiti tankers during the late 80s; humanitarian aid; and ongoing Stability, Security, Transition, and Recovery (SSTR) operations in Iraq.

The DD(X) was picked for this analysis because it represents the cutting edge in warship design. Like the LCS, it has not yet deployed and is unproven; however, by using simulation, we can gain useful insight into her capabilities. Unlike many warships today, the DD(X) meets the U.S. Navy's requirement of a ship "doing more with less," using a mix of technologies never used in warship design. The DD(X) is a multimission warship, hosting a variety of weapons.

The areas of concern for today's surface warrior are the various choke points around the globe. Examples are the Persian Gulf, Straits of Malacca, and Red Sea, to name but a few. These areas have had incidents of high seas piracy and harassment by rogue nations.

What is the solution? What class of ship is best suited for littoral operations? Is it the LCS, the current Arleigh Burke class destroyer (DDG-51), or the new DD(X)? What is the best way to employ these platforms and their respective combinations? What are the vulnerabilities and what information can be passed on to ship designers from this study to assist in assessing future naval warship requirements? These are the questions explored in this study.

B. BACKGROUND AND MOTIVATION

The LCS is a new platform designed for providing multimission support in littoral operations by leveraging new and proven technologies. It has the flexibility to operate independently or as a member of a Surface Action Group (SAG) or squadron, or as part of a Carrier or Expeditionary Strike Group (CSG/ESG). However, the LCS has a large dependency on mission packages, which can limit its capabilities in the event it is not equipped to handle the new threat. The primary motivation for this study is to determine the impact of a mixed squadron, containing the LCS and traditional surface platforms, on Blue forces and mission effectiveness.

The LCS is a focused mission platform, using specially-designed modules to carry out a specific mission. A single LCS is therefore incapable of handling simultaneous missions, whereas it is most capable when operating in a squadron. If the LCS could operate in conjunction with multimission warships, such as the Arleigh Burke Class or DD(X) Class destroyers, perhaps the overall size of each LCS squadron could be lowered, resulting in the leveraging of capabilities without sacrificing mission effectiveness. An adequate force mix could be, for example, one or two destroyers with 3-5 LCSs. In a previous study, Ben Abbott (2008) concluded that the right mix of mission capabilities resulted in a squadron size of 6-10 LCSs, which produces relatively

low friendly casualties with high enemy casualties in each of the three warfare areas: Mine Interdiction Warfare (MIW), Antisubmarine Warfare (ASW), and Surface Warfare (SUW).

C. RESEARCH QUESTIONS

The goal of this study is to analyze and determine the right mix of LCS ships and traditional multimission naval warships, capable of handling traditional threats in a coastal littoral environment without sacrificing mission capability. While this study cannot account for all possible situations or environments, these questions will provide guidance to this research:

- How many LCSs should there be in a squadron when adding multimission warships?
- What is the impact of the reduction of an LCS squadron containing traditional legacy platforms in an environment that may contain multiple threats?
- How effective are the force self-defense weapon systems with regard to completing the required mission?

This study uses simulation, data analysis, and other techniques to investigate these questions and develop a methodology to determine the best configuration of an LCS squadron for a given region, based on the threats that may exist.

D. BENEFITS OF THE STUDY

We know from real-world examples that small boat swarm tactics are a cheap and easy way of thwarting and defeating enemies by using numbers and confusion in the battlespace. Overwhelming an enemy is what small boat swarms want to do and this is a very real concern to the United States Navy. Upon completion of this research, the goal is to provide the Navy with analytical support for the continued development of policies, CONOPS, and tactics for the LCS and its mission packages. Additionally, this study produces insight into the capabilities of an LCS squadron operating with legacy platforms

in an environment that presents many operational challenges. Ultimately, this study will further provide the Navy with a better understanding of the best configuration of an LCS squadron, in conjunction with more traditional platforms, to successfully support joint force operations in an environment rampant with uncertain challenges.

E. METHODOLOGY

Upon completion of this study, it is hoped that the Navy can evaluate operational configurations of an LCS squadron with legacy platforms engaged in littoral operations. Quantifiable measures of effectiveness (MOEs) for two primary mission areas, and a threshold for each, is assigned to measure the effectiveness of a combined LCS/legacy platform SAG.

Parametric analysis will be used to determine probabilities of target acquisition, classification, and neutralization for each mission package. In order to evaluate performance against established success criteria, an agent-based computer simulation is used to place the SAG in numerous scenarios that contain multiple threats.

This study uses an agent-based distillation—a type of computer simulation that attempts to model only the salient features of a situation and not every possible characteristic (Cioppa, Lucas, & Sanchez, 2004). The tool used is Map Aware Non-uniform Automata (MANA), a product developed by New Zealand’s Defence Technology Agency (DTA). The methodology is to develop scenarios that present a range of threats for each mission area. These scenarios are then replicated, many thousands of times, in the simulation tool and the performance of the LCS and the chosen legacy platform is analyzed. Exploratory analysis, or data farming, will then identify previously undetermined characteristics and situations that develop during the simulations (Cioppa, Lucas, & Sanchez, 2004). Statistical analysis and techniques will identify and determine the importance of interactions between variables. The results of the statistical analysis will help identify the best configuration of an LCS squadron for each scenario, noting that LCSs will not operate independently of legacy platforms.

Through quantitative analysis, this study will enhance understanding as to how to supplement an LCS squadron in order to best configure it for a given region and threat set.

THIS PAGE INTENTIONALLY LEFT BLANK

II. MODEL DEVELOPMENT

A. INTRODUCTION

In order to accurately capture how an LCS and DDG-1000 will perform its mission in a littoral environment, scenarios are created that contain both a primary threat and secondary threat. In this chapter, an overview of both LCS and DDG-1000 is given, as well as descriptions of the scenarios used for this study. After covering the scenarios, a brief description of the MANA simulation tool used to model both LCS and DDG-1000 is given. This chapter will also provide details on the approach taken for this simulation.

B. LITTORAL COMBAT SHIP (LCS) DESIGN

1. Overview

The LCS, starting with the USS Freedom (LCS-1), is a new class of fast, agile, and networked warships designed to overcome threats in shallow waters and are key components in a proposed family of next-generation surface combatants that also includes the much larger DDG-1000 destroyer (included in this study), and the future CG(X) cruiser. LCSs will be able to deploy independently to littoral regions throughout the world; remain on station for extended periods of time, either with a CSG or an ESG or through a forward-basing arrangement; and operate independently and/or with an LCS squadron.

The objective of the LCS CONOPS is to allow the Navy to reduce the shipboard manning requirements and maximize asset allocation for the rest of the surface force. The LCS will incorporate advanced technologies, employing cost-optimized advanced weapons; sensors; data fusion; command, control, communications, computers, intelligence, surveillance, and reconnaissance (C4ISR) systems; hull forms; propulsion systems; manning concepts; smart control systems; and self-defense systems (Peoships, 2008).

The most transformational feature of the LCS is its modular capability, which gives maximum mission flexibility. The source of this flexibility resides in the Seaframe concept. The Seaframe is augmented by mission packages that are focused in one of three mission areas: SUW, ASW, or MIW. However, for the purpose of this study, we will only be examining the SUW mission area and the ASW area as the secondary threat. Each mission package contains mission modules that are comprised of different mission systems illustrated in Figure 1. This section provides a detailed look into the Seaframe, as well as the primary mission packages selected from the LCS for this study.

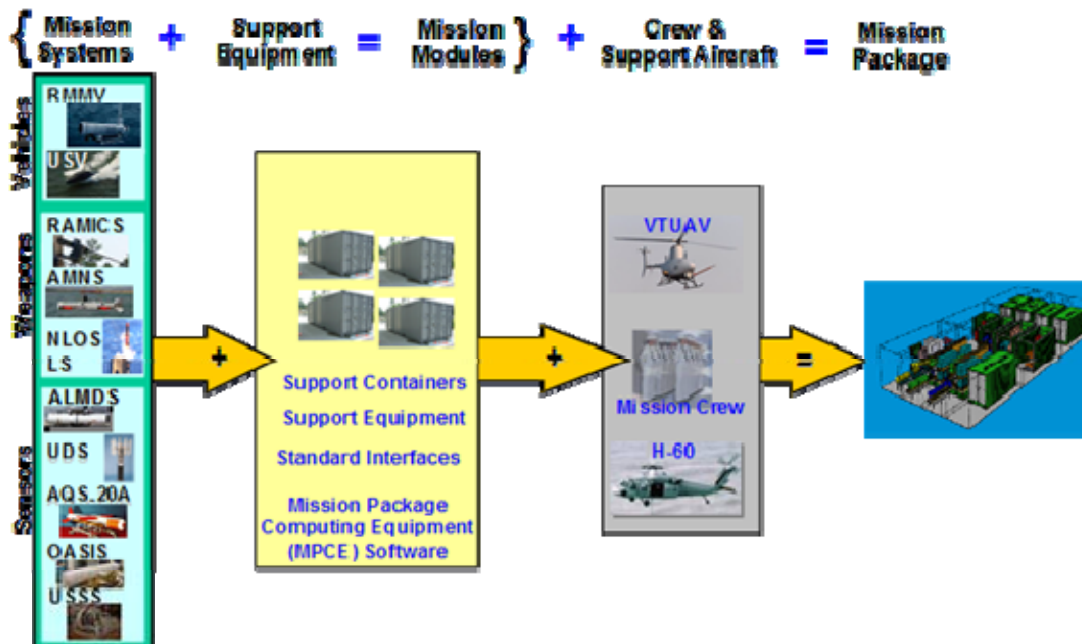

Figure 1. Composition of a mission package (From: Taylor, 2008).

2. Seaframe

As the core of the LCS, the Seaframe provides basic self-defense capability through organic sensors and weapons, and speed. While two Seaframe designs are under construction, both are capable of attaining speeds over 40 knots and are similarly equipped. There are differences between the competing Seaframes, but they are not the focus of this work. Instead, the focus is on the capabilities of the LCS and, specifically, the SUW and ASW mission packages. Figures 2 and 3 show the two competing seaframe designs. Table 1 shows the seaframe sensors and weapons used in this study.



Figure 2. Lockheed Martin Team LCS Design
(From: Program Executive Office Ships, 2008).



Figure 3. General Dynamics-Bath Iron Works LCS Design
(From: Program Executive Office Ships, 2008).

Seaframe Sensors and Weapons	Quantity
Three-dimensional air/surface search radar with periscope detection capability	1
EO/IR mast-mounted sensor	1
Mk-3 57mm gun	1
Crew-served .50-caliber guns	4 mounts
RAM Block 1 air-defense missile (LM)	1 launcher (21 missiles)
SeaRAM missile system (GD)	1 launcher (11 missiles)

Table 1. Sensors and weapons for the LCS seaframe
(From: Naval Warfare Development Command, 2007).

3. Mission Packages

The mission packages provide the mission warfighting capability of the LCS. Three warfare areas have been identified as immediately necessary: SUW, ASW, and MIW. The possibility of additional mission packages are being considered by the Navy, but the focus of this study is on SUW and ASW mission packages.

a. Surface Warfare (SUW)

Designed to detect and engage multiple targets in the littorals, the SUW mission package strengthens the Seaframe by adding a helicopter armed with hellfire missiles, two 30 millimeter guns, and the Non-Line of Sight (NLOS) missile system. (Joint Requirements Oversight Council, 2004) While the MH-60S is listed as a possible part of the SUW mission package, this study models the MH-60R. The SUW mission package, combined with the speed of LCS, provides the Navy with a credible asset to use against surface threats in the littorals. Table 2 shows the systems and weapons contained in the SUW mission package (Abbott, 2008).

SUW Modular Elements	Qty
Vertical Take-Off Unmanned Aerial Vehicle (VTUAV)	2
EO/IR/LD sensor and datalink relay	1
MH-60R/S	1
GAU 16/19 machine gun	1 (60R) or 2 (60S)
Hellfire missiles	8
Non-Line-of-Sight Launch System (NLOS-LS) missile system	60 (4 launchers with 15 missiles each)
Laser designator for NLOS-LS missiles	1
Mk 46 Mod 1 30mm gun system	2
57mm gun system	1

Table 2. Systems and weapons contained in the SUW mission package (From: Naval Warfare Development Command, 2007).

b. Antisubmarine Warfare (ASW)

The ASW mission package takes advantage of off-board technology in the search, localization, and prosecution of enemy submarines. With the inclusion of unmanned vehicles, the ASW-configured LCS is capable of sweeping and maintaining barriers or operating areas, while reducing the risk of casualties. The Unmanned Surface Vehicles (USVs) employ a dipping sonar similar to that used by the MH-60R Helicopter, which is also included in the ASW mission package. The tactic used by a dipping sonar, known as sprint and drift, is not easily modeled in MANA. Therefore, an average search rate was determined for both the MH-60R and the USVs in order to model the effects of the sprint and drift tactic. The Remote Minehunting Vehicles (RMVs) operate differently from the USVs in that the former must operate as a pair. With one RMV towing an active source and the second towing a passive towed array, the pair provides a bistatic sonar capability (Naval Warfare Development Command, 2007). Unlike the SUW LCS, which can fire or launch several SUW weapons, the ASW LCS does not have an antisubmarine weapon that is capable of being delivered by the LCS. Instead, the ASW LCS relies on the MH-60R deploying Mk 54 torpedoes in order to neutralize the enemy. Table 3 shows the weapons and systems contained in the ASW mission package (Abbott, 2008).

ASW Modules	Qty
USV with ASW Systems	2
UDS	1
UTAS	1
MH-60R with	1
Mk 54 Torpedo	Set
ALFS	Set
Sonobuoys	Set
RMV with ASW Systems	2
RTA (MFTA)	1
RTAS	1

Table 3. Systems and weapons contained in the ASW mission package (From: Naval Warfare Development Command, 2007).

4. Additional Capabilities

While only two of the three mission packages have been identified, other capabilities currently exist and additional needs may present themselves in the future. For the purposes of this study, we are only concerned with the SUW and ASW missions. In addition to these mission packages, the LCS has inherent MIO capabilities, and the possibility of a special operations-capable mission package is also being considered (Commander Naval Surface Forces, 2007). The creation of additional mission packages is not limited to special operations, but is being considered for a broad range of operations. The flexibility of LCSs allows for additional mission packages as necessary, as well as creating variations to existing mission packages, which may save cost. This ability to create new mission packages to address a new threat, instead of creating new platforms, is one of the strengths of the LCS program.

C. DDG-1000 DESIGN

1. Overview

Developed under the DD(X) destroyer program, USS Zumwalt (DDG-1000) is the lead ship in a class of next-generation, multimission surface combatants tailored for land attack and littoral dominance, with capabilities designed to defeat current and projected threats and carry out traditional destroyer missions of Anti Air Warfare (AAW), SUW, and Undersea Warfare (USW).

This advanced, multimission destroyer will bring revolutionary improvements to precise, time-critical strike and joint fires for our ESGs and CSGs of the future. It expands the battlespace by over 400%; has the radar cross section of a fishing boat; and is as quiet as a Los Angeles Class submarine. DDG-1000 will also enable the transformation of our operations ashore. Its on-demand, persistent, time-critical strike revolutionizes our joint fire support and ground maneuver CONOPS so that our strike fighter aircraft are freed for more difficult targets at greater ranges. DDG-1000 will

provide a credible forward presence, while operating independently or as an integral part of naval, joint, or combined expeditionary forces.

DDG-1000 will have a crew of 142, including the aviation detachment. This represented major theoretical cost saving compared to crew levels of 330 on Spruance destroyers and 200 on Oliver Hazard Perry frigates. DDG-1000 will have a sensor and weapons suite optimized for littoral warfare and for network-centric warfare.

2. Capabilities

The DDG-1000 is equipped with 20 four-cell Peripheral Vertical Launch System (PVLS) launchers, designed by Northrop Grumman, that are situated around the perimeter of the deck, rather than the usual centrally located Vertical Launch Silo (VLS). This will reduce the ship’s vulnerability to a single hit. Missile systems include Tactical Tomahawk intended to succeed Tomahawk Land Attack Missile (TLAM), Standard Missile SM-3, and the Evolved Sea Sparrow Missile (ESSM) for air defense (see Figure 4).

ASW Modules	Qty
USV with ASW Systems	2
UDS	1
UTAS	1
MH-60R with	1
Mk 54 Torpedo	Set
ALFS	Set
Sonobuoys	Set
RMV with ASW Systems	2
RTA (MFTA)	1
RTAS	1

Figure 4. DDG-1000 Ship Design and Characteristics
(From: Northrop Grumman Shipbuilding, 2008).

The ship will also have two 155mm Advanced Gun System (AGS) guns, designed by BAE Systems, capable of firing up to 100 nautical miles (NM) at a sustained rate of

12 rounds a minute. It will be equipped with a fully automated weapon handling and storage system and a family of advanced munitions and propelling charges, including the Global Position System (GPS)-guided Long Range Land Attack Projectile (LRLAP). Up to 900 rounds of LRAP ammunition will be carried, including technologies derived from the Navy's Extended-Range Guided Munition (ERGM), the U.S. Army's 155mm XM-982 projectiles, and the Defense Threat Reduction Agency (DTRA) 5in projectiles. The ship's Close-In Gun System (CIGS) will be the BAE Systems 57mm Mk 110 naval gun, found on the LCS, with a firing rate of 220 rounds a minute and range of 14km (nine miles).

The radar suite will consist of dual-band radar for horizon and volume search—a Lockheed Martin S-band Volume Search Radar (VSR) integrated with the AN/SPY-3 multifunction radar already being developed by Raytheon for the United States Navy. The two radars are to be integrated at waveform level for enhanced surveillance and tracking capability. The AN/SPY-3 Multifunction Radar (MFR) is an X-band active phased-array radar designed to detect low-observable, antiship cruise missiles and support fire-control illumination for the ESSM and standard missiles. At the heart of the ship's integrated USW will be a dual-frequency (high/medium) bow array and a multifunction towed array. The DDG-1000 will also include two landing spots for helicopters, including Unmanned Aerial Vehicles (UAVs). Figure 5 shows an artist impression of a DDG-1000 in combat.



Figure 5. Artist Impression of DDG-1000 in combat.
(From: Northrop Grumman Shipbuilding, 2008).

D. DESCRIPTION OF SCENARIOS

The initial design for the SUW scenario developed by LT Ben Abbott (2008) was used. Once all the parameters were verified as correct, the DDG-1000 agent was added to the scenario as part of the LCS squadron. All of its SUW capability was also modeled. These scenarios contained the SUW mission as the primary threat and the ASW mission as the secondary threat. This was done to compare results between this effort and prior research. This section explains the different scenarios in detail.

1. SUW Scenario

A CSG is preparing to transit a strait in a contested region. A nation that borders the strait disapproves of the CSG's presence in what it claims as its territorial waters, and is determined to take the necessary actions to prevent the transit. Intelligence reports suggest that the possibility of the CSG being attacked by missile boats is high, but the

number of possible attackers is unknown. These reports further stipulate that enemy submarines may be underway in the strait, and could support the missile boat attack. The locations of the missile boat threat and possible submarine threat are unknown. This straight is also a high traffic area for neutral merchant ships transiting the region. The CSG has asked for a squadron of LCSs to patrol the straight, providing advanced screening and force protection for the CSG. The force will include the new USS Zumwalt (DDG-1000), the Navy's newest Aegis destroyer, which recently completed its first deployment and shakedown cruise.

a. Enemy

The enemy's primary mission is access prevention of the straits to any U.S. vessel. Fast attack guided missile boats deployed in the strait have been ordered to engage any U.S. vessels detected. Due to their individual vulnerability, missile boats often travel and attack as a group. Diesel submarines may or may not be underway in the strait, have been ordered to patrol the entrance of the strait, and to engage any U.S. vessel trying to gain entrance.

b. Friendly

The LCS squadron will vary in size and allocation of mission packages. If an ASW LCS is included in the squadron, it will only use its MH-60R and USV for detection and prosecution of submarines due to the speed necessary for timely completion of the mission. The squadron will transit the strait at 20 knots, with its respective helicopters deployed, searching for missile boats. If an ASW LCS is included in the squadron, this allows the use of the ASW MH-60R as both a scout and pouncer for enemy submarines, and uses the SUW MH-60R as a scout for early detection of missile boats (Abbott, 2008). The DDG-1000 will provide the LCS squadron with the bigger surface picture, as it uses its SPY-3 Aegis sensor capability to screen the force of all enemy threats operating in the area.

c. Mission

The mission of the combined LCS/DDG squadron is to clear the strait of any missile boat threats in order to provide a safe transit for the CSG, while minimizing the number of friendly casualties. Any detected submarines will be considered as supporters of the missile boat threat, and viewed as targets of opportunity. Figure 6 shows the SUW scenario at problem start (Abbott, 2008).

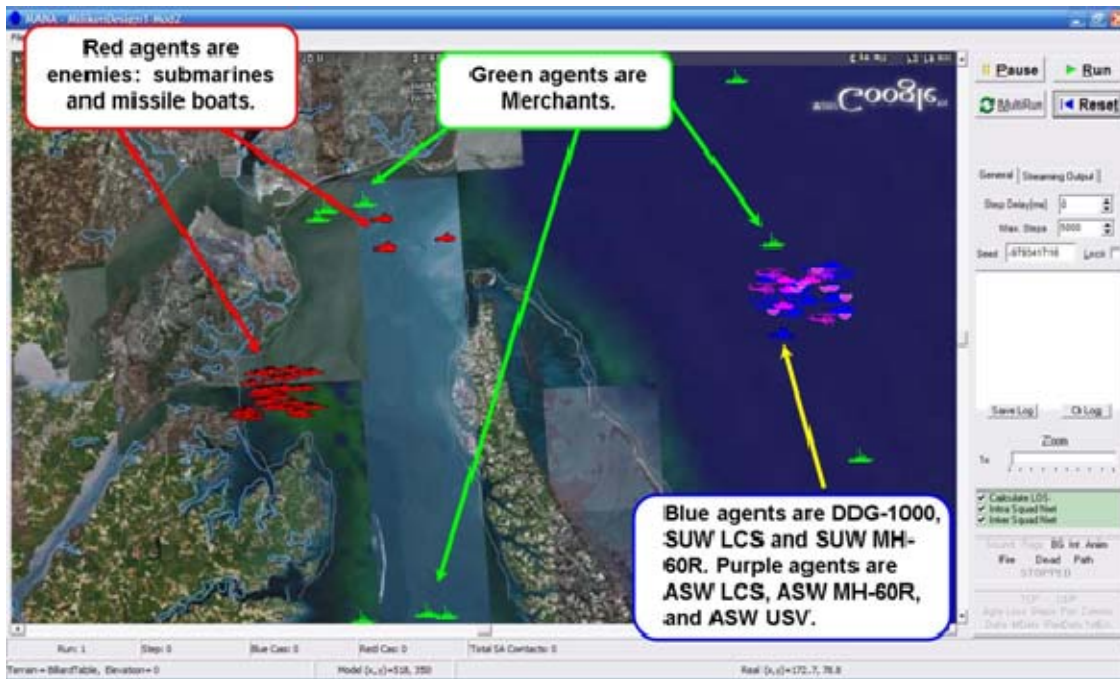

Figure 6. Screen shot of SUW Scenario from MANA.

2. AAW Scenario

A CSG is preparing to transit a strait in a contested region. A nation that borders the strait disapproves of the CSG's presence in what it claims as its territorial waters, and is determined to take the necessary actions to prevent the transit. Intelligence reports suggest that the possibility of the CSG being attacked by multiple threats is high, but the number of possible attackers is unknown. The reports further stipulate that the enemy may employ the use of strike aircraft in support of surface and subsurface combatants to attack friendly forces. The locations of the threats are unknown. This strait is also a high

traffic area for neutral merchant ships transiting the region. The CSG has asked for a squadron of LCSs to patrol the strait, providing advanced screening and force protection for the CSG. The force will include the new USS Zumwalt (DDG-1000), the Navy's newest Aegis destroyer, which recently completed its first deployment and shakedown cruise.

a. *Enemy*

The enemy's primary mission is access prevention of the straits to any U.S. vessel. Fast attack guided missile boats that are deployed in the strait, supported by air cover, have been ordered to engage any U.S. vessels detected. Due to their individual vulnerability, the enemy has bolstered its resolve providing Surface Combat Air Patrol (SUCAP) for the missile boats, which usually travel and attack as a group. These strike aircraft will engage all friendly force air and surface targets. Diesel Submarines, which may or may not be underway in the strait, have been ordered to patrol the entrance of the strait and to engage any U.S. vessel trying to gain entrance.

b. *Friendly*

The LCS squadron will vary in its size and allocation of mission packages. If an ASW LCS is included in the squadron, it will only use its MH-60R and USV for detection and prosecution of Submarines, due to the speed necessary for timely completion of the mission. The squadron will transit the strait at 20 knots, with its respective helicopters deployed, searching for missile boats. If an ASW LCS is included in the squadron, this allows the use of the ASW MH-60R as a both a scout and pouncer for enemy Submarines, and uses the SUW MH-60R as a scout for early detection of missile boat (Abbott, 2008). The DDG-1000 will provide the LCS squadron with the bigger surface picture, as it uses its SPY-3 Aegis sensor capability to screen the force of all enemy threats operating in the area. The DDG-1000 SPY-3 sensor suite will be critical to the squadron's survivability in the event of a combined enemy forces attack. The SPY-3 can detect strike aircraft from ranges beyond that of the LCS.

c. Mission

The mission of the combined LCS/DDG squadron is to clear the strait of any enemy threats in order to provide a safe transit for the CSG, while minimizing the number of friendly casualties. All aircraft that take an aggressive profile against the squadron, and have been classified as hostile, will be fired upon. Any detected Submarines will be considered as supporters of the missile boat threat, and viewed as targets of opportunity. Figure 7 shows the AAW scenario at problem start (Abbott, 2008).

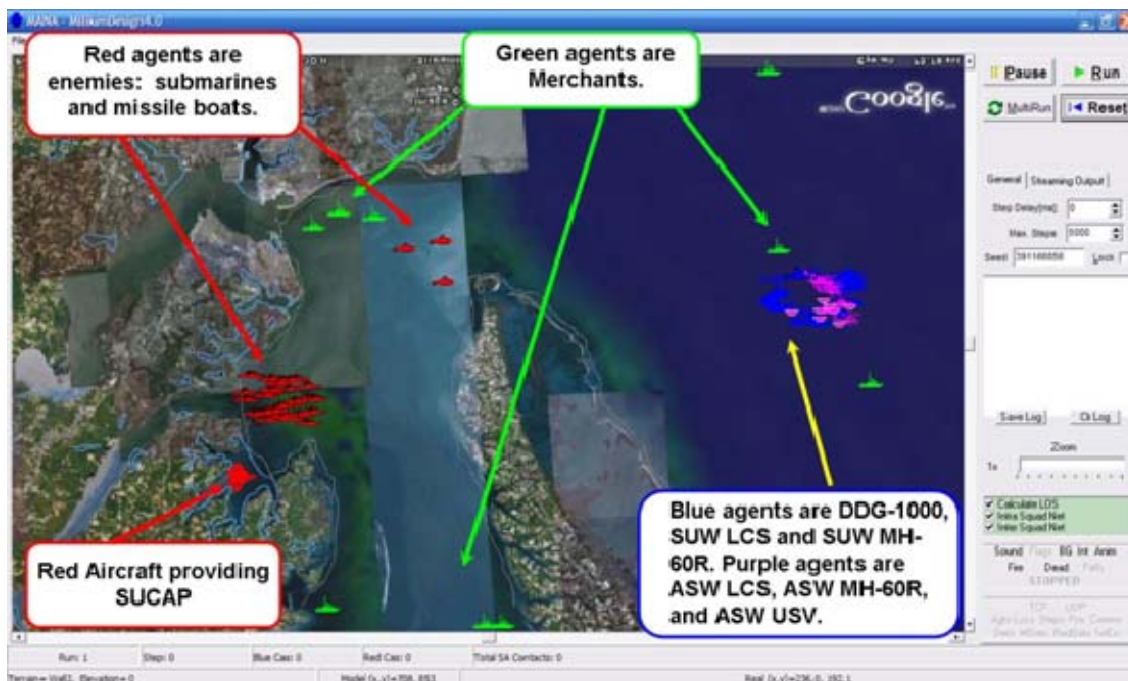

Figure 7. Screen shot of AAW Scenario from MANA.

E. MAP AWARE NON-UNIFORM AUTOMATA (MANA) SIMULATION MODEL

The agent-based distillation tool called MANA version 4.0 was chosen because it allowed the greatest fidelity and flexibility to tailor scenarios to accomplish the task of this study. This section discusses the reasons behind the use MANA 4.0 and not other available simulation tools.

1. The Decision to Use MANA

Initially, this study was going to involve the modeling of ships in a scene graph environment using tools such as SAVAGE Studio, developed by the Modeling, Virtual Environments, and Simulation (MOVES) Institute at the Naval Postgraduate School (NPS). This allows a user or modeler to take a pictorial representation of a ship and place it into a scene in which, through the manipulation of JAVA programming, the ship or entity interact within the parameters of the scene created. However, after an introduction to MANA by Professor Curtis Blais, it was in the best interest of this project to use this simulation tool, as it would be able to model both tactics and the specific characteristics of the ships in a customized, agent-based simulation environment. MANA allows a robust environment to be created in a very short time window, which is a strong suit of this tool. Figure 8 is a snapshot of the MANA 4 start-up screen for reference.



Figure 8. Screen shot of MANA start-up screen. Website contains more reference material (From: MANA 2007).

MANA is a combat model developed and given to NPS by New Zealand's Defence Technology Agency (DTA); it is very user friendly, with a quick learning curve, enabling the modeler to perform excellent, quick turn around experiments. MANA allows the user to create numerous scenarios and models. Agent-based personalities that apply to sensors, weapons, and other parameters are easily manipulated and, more importantly, MANA lends itself to data farming.

F. CHARACTERISTICS OF MANA

MANA is in a general class of models called Agent-Based Models (ABMs). ABMs have the characteristic of containing entities that are controlled by decision-making algorithms. Hence, an agent-based combat model contains entities representing military units that make their own decisions, as opposed to the modeler explicitly determining their behavior in advance (MANA 2007).

To differentiate MANA and ISAAC/EINSTEIN, etc., from highly detailed models that can also use agents, MANA and similar tools are sometimes called Agent-Based Distillations (ABDs). This reflects the intention to model the essence of a problem. MANA falls into a subset of these models, called cellular automaton (CA) models. CA models have their origin in physics and biology. The famous Ising model of magnetic spin alignment is an example of such a model in physics, while Conway's "Game of Life" is an example of a CA model designed to explore biological ideas. MANA and other CA models are often called complex adaptive systems (CAS) because of the way the entities within them react with their surroundings (MANA 2007).

The MANA model is an attempt to create a complex, adaptive system for some important real-world factors of combat such as:

- Change of plans due to the evolving battle.
- The influence of situational awareness when deciding an action.
- The importance of sensors and how to use them to best advantage.

The difference between MANA and other agent-based combat models is that MANA builds on and complements the earlier ISAAC/EINSTEIN CA models developed by the Center for Naval Analyses, and the now discontinued Archimedes model that was being designed for the United States Marine Corps. Its primary use is as a “distillation” tool; that is, to create a bottom-up abstraction of a scenario that captures just the essence of a situation, but avoids nonessential detail. MANA was designed to explore key concepts that ISAAC (at that time) was unable to explore: situational awareness, communications, terrain map, waypoints, and event-driven personality changes (MANA 2007).

1. Simulation Goal

The scenarios developed for this study are designed to gain insight into the size and composition of an employed LCS squadron when augmented by multimission platforms, such as a DDG. The primary MOE is not the number of enemy killed, but the number of friendly force casualties suffered. The important factors in this simulation are the number of enemy combatants, the number and type of LCSs, the number of DDGs, the probability of detection by friendly sensors, and the probability of kill for friendly weapons.

2. Terrain and Scale

MANA is a time step model that requires a coupling of simulation time and real time, as well as the simulation world and the real world. In this simulation, each time step is equal to 30 seconds. Each scenario lasts no longer than 5,000 time steps, which is slightly less than 48 hours. The simulation map is 1,000 pixels by 1,000 pixels, corresponding to a real-world map of 335 NM by 225 NM. This produces a pixel to nautical mile ratio of about 3:1, which provides for accurate modeling of agent movements. This means that each pixel is approximately equivalent to 1/3 of a nautical mile. If large pixels to nautical mile ratios are used, agents could move in unrealistic ways. The above couplings results in a single run lasting anywhere from 7 to 90 minutes

on computers with processor speeds ranging from 448 MHz to 3.19 GHz. The source of variation in these run times is the number of agents involved in that given run (Abbott, 2008).

MANA was originally designed to model land warfare; however, MANA does provide a good foundation for creating other types of scenarios. Terrain such as hilltops, brush, roads, and walls give way to islands and water. Since these scenarios are all nautical, terrain is not used, with the exception of the wall and hilltop feature. The wall feature is used to prevent ships and submarines from running aground, and the hilltop feature is used in the SUW scenario to prevent agents from detecting and engaging each other over a peninsula. A terrain map was created by selecting the desired area map and then using the MANA Scenario Map Editor to line the land in the map with the wall feature, while covering the peninsula with the hilltop feature. This terrain map is used by the agents to assess situational awareness. The different terrain features are assigned different colors in MANA: gray is the color for the wall feature and dark gray identifies the hilltop feature. Figure 9 shows the terrain and background maps.



Figure 9. Terrain (left) and Background (right) maps used in both scenarios. The gray lining the land on the terrain map is the wall feature and the dark gray covering the peninsula is the hilltop feature (From: Abbott 2008).

The terrain map is not the map seen by the user while conducting runs; what is seen is the background map. This allows the user to show a recognizable, real-world map during simulations without affecting the agent's simulation awareness. Essentially, the terrain map is for the agents and the background map is for the user (Abbott, 2008).

3. Enemy Forces

Each enemy agent is assigned a starting location in the scenario. Submarines will independently patrol this position until they detect an enemy or take fire. Submarines will pursue a detected friendly agent and will evade if fired upon by increasing speed and taking random courses away from friendly forces. These traits are also used by missile boats, with minor variations. While missile boats do not patrol, they transit and attack as a group for safety and cumulative strength. When a friendly agent is detected, the missile boats will pursue, and when taking fire, the missile boats will try to evade while pursuing and engaging the friendly agent. In the AAW scenario, both aircraft and missile boats are linked to their respective platform, providing an advantage and allowing coordination of attacks. Submarines are not linked, due to the strong likelihood that they would remain hidden from one another and operate independently.

4. Friendly Forces

Friendly Blue forces are assigned a starting position as well with waypoints specific to each scenario. Each variant of LCS transits from the home position through the waypoints, engaging detected enemies when they are capable. The helicopters associated with the mission packages transit along with the LCS according to their speeds, and will pursue and engage any enemies detected. Fuel consumption is modeled for the helicopters, with the SUW MH-60R needing to refuel every 3.5 hours, and the ASW MH-60R requiring refueling every 3 hours due to their search tactics. During their refueling, which lasts 45 minutes, none of the helicopters can detect or engage enemies. The off-board vehicles behave similar to the helicopters, with the exception of engaging enemies and fuel. None of the unmanned off-board vehicles carry weapons, which limits them to pursuing the enemy and passing this detection to their respective LCS (Abbott, 2008).

5. Sources, Abstractions, and Assumptions

With every simulation, the source of input data and assumptions are quite important. In this simulation, command, control, communication, computers and intelligence (C4I) and logistics are assumed to work perfectly, i.e., regarding logistics, the location and number of available mission packages is not considered, and fuel (with the exception of helicopters) is unlimited. Failure of equipment and maintenance is also not considered in this simulation.

Enemy force sensor and weapon information, number of weapons per enemy agent, and capabilities of certain friendly sensors and weapons were taken from *Jane's Fighting Ships 2006*, *All the World's Aircraft 2006*, the Federation of American Scientists Website, and the Global Security Website. The values given to enemy sensors and weapons were generalized and reviewed by Dr. Tom Lucas, Ph.D., combat modeling expert at NPS, Captain Jeff Kline, USN (Ret.) and Chair of Warfare Innovation at NPS.

Both the ASW MH-60R and the ASW USV use a dipping sonar to detect submarines—a tactic known as “sprint and drift.” Since this tactic is not easily modeled in MANA, effective search rates were developed as an abstraction. The search rates are based on 5 minutes lowering the sonar, 5 minutes operating the sonar, 5 minutes hoisting the sonar, and 5 minutes sprinting to the next search area. The search rates result in an aggregate speed of 20 knots for the ASW MH-60R and 12 knots for the USV. These search rates, as well as the refueling information for the helicopters, were validated previously by Jeff Kline, and CDR Doug Burton, USN, Military Instructor at NPS and SH-60B pilot (Abbott, 2008).

This model assumes that each LCS chooses to operate with its armed helicopter deployed and that the DDG uses a data-link to pass contact information to the friendly forces. In this scenario, the DDG does not model the MH-60 or UAVs that would normally be embarked. Only the DDG weapon systems and advanced sensors are modeled in this study. This being the case, UAVs contained in the mission packages are not modeled. Characteristics and capabilities of the LCS and its off-board vehicles were

provided by CAPT Mike Good, USN, and LCDR Bill Harrell, USN. The number of enemy and friendly agents, as well as the probabilities associated with the friendly sensors and weapons are explored through a Nearly Orthogonal Latin Hypercube (NOLH) and will be discussed in Chapter III. The ranges over which these parameters are explored were previously reviewed by Dr. Lucas, Jeff Kline, and Colonel Ed Lesnowicz, USMC (Ret.), and updated with new information for this study.

Very rarely does a simulation tool perfectly fit the problem being modeled. Frequently, modeling issues are discovered during the model development process and are either fixed through the developers of the tool or addressed through other modeling work arounds. In this study, two such modeling issues were discovered. The first issue is the ability of the ASW LCS to detect submarines at the range of its surface search radar. This occurs because, in MANA, the submarines are modeled as surface contacts and the non-ASW-capable assets are programmed to ignore this specific threat. ASW capable assets, however, are programmed to engage any detected submarines. In order to work around this modeling issue, ASW LCSs were not allowed to pass submarine contacts to its ASW MH-60R, and were given a stand-off distance of 10 nautical miles from detected submarines. This prevented the ASW LCS from engaging submarines from unrealistic distances, and prevented the ASW LCS from driving into the torpedoes of an enemy submarine. While this modeling issue does mean that an ASW LCS can detect an enemy submarine, it does not provide an unfair advantage due to the modeling work arounds mentioned, and the ASW LCS's inability to deploy an ASW weapon (Abbott, 2008).

The second modeling issue is dealing with aircraft and surface contacts. Often the weapons designed to shoot enemy surface targets would engage aircraft and vice versa. To get around this, the advanced options under the weapons tabs were modified so that the weapon would only engage class-specific targets, to get the needed realism in the scenario.

The third modeling issue was the effective use of the DDG's SPY-3 radar. Since sensors in MANA see all targets on the same plane, it necessary to allow the radar to only

see aircraft and not see surface contacts or aircraft. It was decided to use the A and B band settings along with stealth to correctly detect the threats to SPY-3. Thus, aircraft could be seen in the A band, but all the surface contacts would be 100% stealth, basically invisible. For surface contact detection, B band was selected, and in this mode, the aircraft would appear invisible when using 100% stealth. This change allowed the DDG SPY-3 sensor to operate in a more realistic manner.

During the model generation phase, the model was reviewed weekly by simulation experts and analysts to ensure the agent behaviors were adequately modeled. The model benefited from input from military officers, analysts, and simulation experts available at NPS. This feedback was used to produce accurate scenarios that would produce quality results.

6. Summary

For this study, a combat modeling tool was used to develop scenarios that examined the threat environment that an LCS squadron, supported by DDGs, would likely engage. The scenarios looked at the two specific primary warfare areas, SUW and AAW, to stress both ship types in order to provide insight into squadron size, composition, and the significance of the technologies employed aboard both platforms. The result is a simulation that captures the capabilities of both of these platforms, and the inherent risks of operating in littoral areas against an opposing force. Chapter III will discuss the experiment design, assumptions, its many factors and variables, and how they come together in the scenario. These scenarios provide insight into how the LCS and DDG platforms can provide mission support across several warfare areas.

THIS PAGE INTENTIONALLY LEFT BLANK

III. DESIGN OF EXPERIMENT

A. INTRODUCTION

This study is follow-on to research conducted by LT Ben Abbott (2008). Most the information in this section is reused, as it provided the necessary framework and foundation to which the study is presented. Deviations from this study are also presented in order to gain further insight into the model. The model deals with two distinct situations, stemming from the mission that an LCS squadron would face in a littoral combat environment: (1) an LCS squadron augmented by a multimission ship, in this study the DDG-1000, in a surface engagement involving a missile boat swarm supported by diesel submarines; (2) the same squadron composition faced with both the SUW threat supported by aircraft. The aircraft would attempt Anti-Surface Warfare (ASuW) and Anti-Air engagements against the Blue friendly forces. These scenarios provide insight into how the multimission platform can provide mission support across several warfare areas.

For this study, a technique called data farming was used. Simply stated, data farming uses a simple simulation model that is run numerous times, while simultaneously changing the input parameters (Bain, 2005). The result is an output that covers a large number of possible outcomes. This technique helps provide a better understanding of the system being analyzed and identifies regions that contain interesting events (Cioppa, Lucas, & Sanchez, 2004). This chapter addresses the variables used in this study, followed by an explanation of the different designs used throughout the study.

B. MODEL ASSUMPTIONS

Listed here are the important assumptions made with this model. There are two types of variables used in these simulation—those that are controllable and those that are uncontrollable. Controllable variables are those that can be altered by the user. Uncontrollable variables are those that the user cannot control. Controllable variables are

referred to as decision factors, while uncontrollable variables are considered noise factors. This study focuses on the decision factors in order to provide greater insight into two new, yet widely different platforms, with the hope of gaining valuable feedback for further study. Enemy sensor and weapon ranges, as well as their associated probabilities of detection and kill are fixed, making the number of enemies the only enemy variable. It is important that one variable be held, in this case the red forces, while the Blue forces are varied so that changes in the model can be analyzed. Modeling details for each agent and their sensors and weapons is provided in Appendix A. Table 4 summarizes the variables used, their ranges, and a brief explanation.

Factor	Value Range	Description
DDG	1...7	The number of DDG in a given run.
SUW LCS	1...30	The number of SUW LCS in a given run.
ASW LCS	0...5	The number of ASW LCS in a given run.
SUW MH-60R Probability of Detection (Pd)	0.5...1.0	Probability of detection for the SUW MH-60R sensor.
ASW MH-60R Pd	0.5...1.0	Probability of detection for the ASW MH-60R sensor
ASW USV Pd	0.5...1.0	Probability of detection for the ASW USV
ASW RMV Pd	0.5...1.0	Probability of detection for the ASW RMV
DDG Pd	0.5...1.0	Probability of detection for the SPY-3 AEGIS system
LCS Pd	0.5...1.0	Probability of detection for the LCS Seaframe
Standard Missile (RIM-156)	0.5...1.0	Probability of kill for the Standard missile system
155mm Probability of Kill (Pk)	0.5...1.0	Probability of kill for the 155mm gun system
NLOS Pk	0.5...1.0	Probability of kill for the NLOS missile System
57mm Pk (Mk110)	0.5...1.0	Probability of kill for the 57mm gun system
30mm Pk	0.5...1.0	Probability of kill for the 30mm gun system
Rolling Airframe Missile (RAM) Pk	0.5...1.0	Probability of kill for the RAM point defense
.50 Caliber Pk	0.5...1.0	Probability of kill for the .50 Caliber guns
Blue Torpedo Pk (Mk54)	0.5...1.0	Probability of kill for the torpedo used by the ASW MH-60R
Hellfire Pk	0.5...1.0	Probability of kill for the Hellfire missile system used by the SUW MH-60R
Red Missile boats	5...50	Number of enemy missile boats in each run
Red Submarines	1...5	Number of enemy submarines used in each run
Red Aircraft	1...30	Number of enemy aircraft used for in run
Merchants	0...5	Number of outbound, inbound and anchored merchants used for each run

Table 4. Variable factors used in the experiment design. Modeled Factors are in grey, and noise factors are in white.

1. Controllable Factors

The following variables were used in order to look at the effectiveness of the LCS/DDG squadron. Since a fixed number of systems (i.e., helicopters and USVs) come with each type of LCS mission package, only the number of LCSs is varied. All of these variables were previously modeled by LT Ben Abbott (2008) and hence only new models were introduced in order to determine what the impact of a multimission platform, such as a DDG, would be if it were a part of an LCS squadron.

a. SUW LCS

The number of SUW LCSs in the LCS squadron for a given run. For the SUW scenario, this is varied from 1 to 30 due to the surface threat being primary.

b. ASW LCS

The number of ASW LCSs in the LCS squadron for a given run. For the SUW scenario, this is varied from 0 to 5 due to the submarine threat. ASW LCSs are modeled in all scenarios.

c. DDG-1000

The number of DDG-1000s in the LCS squadron for a given run. For all of the scenarios, this varied from 1 to 7.

d. SUW MH-60R Probability of Detection (Pd)

The probability of detection associated with the sensor for the SUW MH-60R. The sensor being modeled is the AN/APS-147 surface search radar. This variable is modeled in all scenarios.

e. ASW MH-60R Pd

The probability of detection associated with the sensor for the ASW MH-60R. The sensor modeled is the AN/AQS-22 dipping sonar. This variable is modeled only in the SUW scenarios.

f. DDG Pd

The probability of detection associated with the sensor used by the Zumwalt Class destroyer. The sensor modeled is the advanced SPY-3 Multi-Function Radar (AEGIS) System that is used by the DDG-1000, and assumed to have all of its capabilities working. This variable is modeled in all scenarios.

g. LCS Pd

The probability of detection associated with the sensor used by the LCS Seaframe. The sensor modeled is the 3D surface search radar that will be used by LCS. This variable is modeled in all scenarios on all types of LCS.

h. ASW USV Pd

The probability of detection associated with the sensor used by the USV. This study models the use of the Unmanned Dipping Sonar (UDS), which operates similarly to the AN/AQS-22 of the ASW MH-60R.

i. NLOS Probability of Kill (Pk)

The probability of kill associated with the NLOS missile system used in the SUW mission package. This variable is modeled in all scenarios.

j. 57mm Pk

The probability of kill associated with the Mk-110 57mm gun system used by the LCS Seaframe and DDG-1000. This variable is modeled in all scenarios.

k. 30mm Pk

The probability of kill associated with the 30mm gun systems used in the SUW mission package. This variable is modeled in all scenarios.

l. RAM Pk

The probability of kill associated with the Rolling Airframe Missile (RAM) system point defense system used by the LCS Seaframe. This variable is modeled in all scenarios, on all types of LCS.

m. .50 Caliber Pk

The probability of kill associated with the .50 caliber crew-served weapons used by the LCS Seaframe. This variable is modeled in all scenarios, but only on the ASW LCS.

n. Blue Torpedo Pk

The probability of kill associated with the Mk 54 torpedo employed by the ASW MH-60R. This variable is modeled in all scenarios.

o. Hellfire Pk

The probability of kill associated with the Hellfire missile system that is used by the SUW MH-60R. This variable is modeled in all scenarios.

p. 155mm Pk

The probability of kill associated with the 155mm AGS used by the DDG-1000 class. This is a secondary weapon and is used as such. The weapon is employing only conventional .62 caliber rounds for close-in, ship-to-ship combat.

q. Standard Missile Pk

The probability of kill associated with the Radar Intercept Missile (RIM-156 standard missile system. The standard missile is a VLS-capable, extended-range, surface-to-air missile. This variable is modeled only in the AAW scenario.

2. Uncontrollable Factors

The following uncontrollable variables were chosen in order to ensure the scenarios are realistically uncertain and to explore the capabilities of both the LCS and DDG-1000 over a range of conditions. These variables are factors that a decision maker is unable to affect and are seen as noise factors.

a. Missile boats

The number of missile boats used in a given run. The number of missile boats is varied from 5 to 50 in the SUW scenario due to their role as the primary threat. The missile boats are modeled after the Chinese Fast Attack Craft – Missile (PGGF), and are modeled in all scenarios.

b. Submarines

The number of submarines used in a given run. They are varied from 1 to 5 in the SUW scenario, where they serve as a secondary threat. The submarines are an abstraction of various Soviet-built Kilo class diesel submarines and are in all scenarios.

c. Aircraft

The number of aircraft used in a given run. The number of aircraft is varied from 1 to 30. The aircraft are modeled after the Sukhoi SU-24 Fencer produced by the former Soviet Union and is widely marketed throughout the world. This variable is modeled only in the AAW scenario.

d. Merchants

The number of each type of merchant (outbound, inbound, and anchored) used for a given run. The adding of merchants provides realism to the scenarios in that they add to the surface clutter for both friendly and enemy sensors. Neither the enemy nor the LCS squadron is interested in engaging the merchants, but their presence makes detection and classification more difficult. All three types of merchants (outbound, inbound, and anchored) are modeled in both the SUW and AAW scenarios. As such, the number of merchants in each run, times the three types of merchants, will provide the total number of merchants for that run. Merchants are used in the scenarios to provide surface clutter, making detection more difficult for both forces.

C. EXPERIMENT DESIGN

For this study, like that of LT Abbott (2008), three stages were used. An initial exploratory design is implemented to gain familiarity with MANA and to debug any modeling issues. Essentially, this step was used as base knowledge and to understand MANA. Secondly, a preliminary design was created in order to ensure that scenario specific agents are being modeled correctly and to identify any last minute concerns. LT Abbott's (2008) design1.xml SUW scenario file was used in order to understand the various interactions of the agents in the model. This was the stepping stone to the final experiment, which was used to obtain the data. This section explains these three designs in detail, as well as the experimental design tool used to create them.

1. Exploratory Design

To understand MANA's ability to address the LCS and DDG interaction, an exploratory design of the SUW scenario was created. Since LT Abbott (2008) provided the basis for the SUW scenario, a model of the DDG had to be created and explored to provide continuity in the scenario. This exploratory scenario was very abstract, and included only a primary threat (a missile boat swarm), and is intended to provide insight and understanding of the agents and the model in the SUW scenario. Several input

variables are used: number of DDGs, number of missile boats, DDG Pd, and weapon system model capability. These variables are varied through the NOLH, creating 65 different input combinations. Each of these scenarios were replicated 30 times, resulting in 1,950 simulations. These data points are used to help further develop the simulation model.

2. Preliminary Design

Since this design is based only on LT Abbott's (2008) design1 base case SUW scenario, additional agents and capabilities are required in order to accurately model the other warfare areas and weapon system capability. The preliminary design was created to provide a more detailed look at the specific scenario after the refinement from the exploratory design. The total number of input variables was 19. This number was necessary for the SUW scenario.

In order to capture as much of the input space as possible, these factors are varied through the NOLH creating 257 different situations for each scenario. These runs were replicated 30 times each, resulting 7,710 scenarios and 15,420 simulated battles. These data points were analyzed and the results reviewed by simulation experts on MANA, research analysts, and subject matter experts to ensure that the scenarios were being modeled correctly before conducting the full experiment. Some of the insights provided from these preliminary results include: the addition of the AAW scenario, and modeling air-to-air combat, air-to-surface engagement, and AAW. The remaining agents from LT Abbott's (2008) study were retained for this study.

3. Full Design

Once the inputs and feedback gained from the preliminary design were provided, adjustments were made to the agent behaviors, and the simulation model, so the full design could be implemented. Since no additional input variables were identified, the same 257 runs created by the NOLH for the preliminary design were used. Each of these runs were again replicated 30 times each, resulting in 7,710 scenarios and 15,420

simulated battles. These data points were used as the research data and the basis for this study, which is covered in Chapter IV.

4. The Nearly Orthogonal Latin Hypercube (NOLH)

The NOLH experimental design technique was developed at NPS by LTC Thomas Cioppa, United States Army, in 2002. The technique was designed to efficiently explore simulations that have a large input space, requiring minimum a priori assumptions (Cioppa, 2002). Just as in LT Abbott's (2008) study, here we reveal the orthogonality of the input variables. This provides the resulting data statistical properties that allow for efficient analysis. The space-filling property of the NOLH allows the analyst to explore more of the input space than the traditional factorial design, in which only high and low values are considered. A NOLH generation tool created by Professor Susan Sanchez at NPS is used to generate the designs for this study. A detailed table of the experimental design used for this study can be found in Appendix B. Figure 10 shows the orthogonality and space-filling properties of the NOLH through the use of a scatter plot matrix.

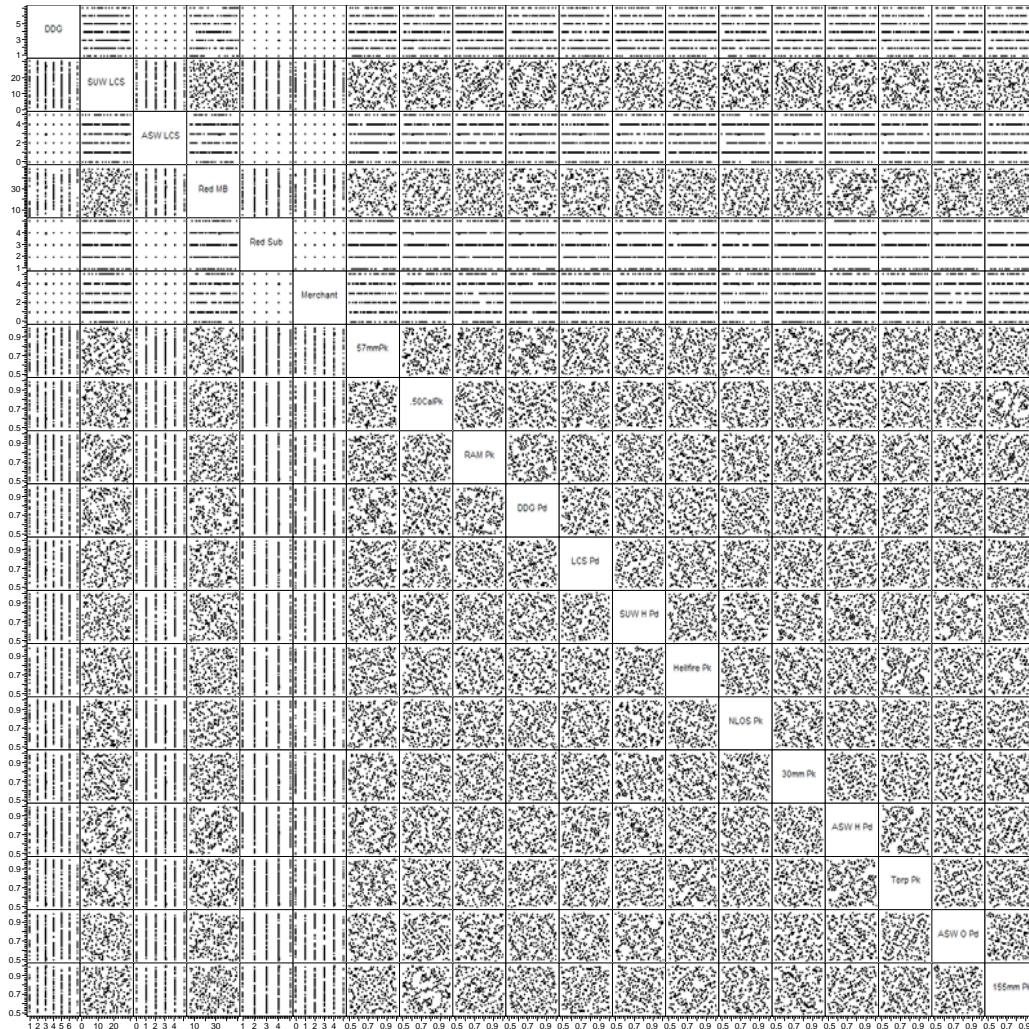

Figure 10. Scatter plot matrix of the variables in the SUW scenario illustrates the orthogonality and space-filling properties of the NOLH. Labels on the diagonal are the names of the variables.

D. MODEL EXECUTION

MANA uses eXtensible Markup Language (XML) files to run simulations. After identifying the input variables and creating the scenarios through the NOLH, an XML file had to be created for each scenario. In short, these programs take the inputs from the NOLH and use them to generate 257 variations of the base XML file for each scenario. The subsequent XML files were then placed on a cluster of computers operated by the Simulation Experiments and Efficient Designs (SEED) Center for Data Farming at NPS.

This cluster of high-performance computers conducted the simulations for both the preliminary and full designs (Abbott, 2008). The preliminary designs took approximately one day for the entire run to complete. The results of the exploratory and final, or full, design took approximately 15 hours on the cluster, which created 15,420 simulated battles.

This chapter discussed the methods and techniques used to build the scenarios for this study. Chapter IV explains the data analysis methodology, and the tools used to investigate the scenario outcomes in MANA in order to draw conclusions about the effectiveness of the scenarios presented.

THIS PAGE INTENTIONALLY LEFT BLANK

IV. DATA ANALYSIS

A. INTRODUCTION

This chapter explains how the data are collected, our analysis methodology, and the designs and statistical tools used to explore the scenario effectiveness in MANA and the insights gained. The purpose is to provide insight into the model, which describes the output data, in order to draw conclusions about the effectiveness of the scenarios presented. This analysis is a follow-on study to LT Abbott's conducted in 2008. It provides answers to his future research question: What is the affect of multimission platforms, on an LCS squadron's composition and size?

B. PROCESSING THE DATA

Since MANA uses XML files to run simulations, the output provided is in the form of comma-separated values (CSV). This file allows for simple processing and provides the number of injuries and casualties for each agent, as well as the total Blue force and total Red force using MANA's numbering scheme to identify the different agents. In order to compile the output data with the 257 rows of input variables that originated from the NOLH, a summary of the scenario output file was needed. A statistical software package called JMP (version 7.0) was used to analyze the data by importing the output into JMP.

Once the input was complete, a calculation of the means of each input combination was done. These 257 rows of mean values were then coupled with the input data to create the summary data set used for analysis. This was done to compare results to the same method that LT Abbott (2008) used to analyze his data set in order to gain insight to any significant changes. The MOEs used in this study are the mean total Blue casualties and the mean total LCS casualties when a multimission combatant is added to

the LCS squadron. While the mean total Blue casualties encompass the entire friendly force including unmanned vehicles, the mean total LCS casualties considers only the number of LCSs killed.

C. RESEARCH QUESTIONS AND CONCERNS

In Chapter I, three questions were asked as the foundation of this study. Each question is addressed through data analysis and discovery. This analysis includes the use of several analytical tools, including regression trees. Regression trees are exploratory models that help reveal structure in data. An example would be finding a clear change in the impact on the numbers of ships in the scenario. These are also helpful in summarizing large data sets with many variables. In Appendix C, there is a compilation of the graphs and regression results used in conducting this analysis.

1. Impact of the Addition of Multimission Platforms on LCS Squadron Size

This section looks at the impact of the addition of multimission platforms on LCS squadron size for each of the scenarios.

a. SUW Scenario

In order to determine the impact that a multimission combatant such as the Zumwalt Class DDG has on an LCS squadron, the original scenario was recreated with the addition of the new DDG agent. To understand the relationship between the variables, the same method of regression (i.e., main effects) was used in LT Abbott's (2008) study. Figure 11 shows that SUW LCSs and missile boats are the most statistically significant in this scenario, and the regression explains 84 percent of the variance in mean total Blue casualties. These same variables are also statistically significant and consistent in predicting mean total LCS casualties. The ASW LCS and Submarines are not shown to be statistically significant. This analysis reveals that SUW LCSs and missile boats are the dominant factors in the SUW scenario.

In the case of Figure 11, the number of SUW LCS and missile boats are the most influential factors on mean total Blue casualties, which is quantified by their t-ratios—the larger the t-ratio, the more statistically significant the factor. The estimate column of the regression analysis shows the contribution of each factor to the MOE. For example, for each missile Boat added to the engagement, mean total Blue casualties will increase by 0.356. Estimates with negative values will decrease the MOE.

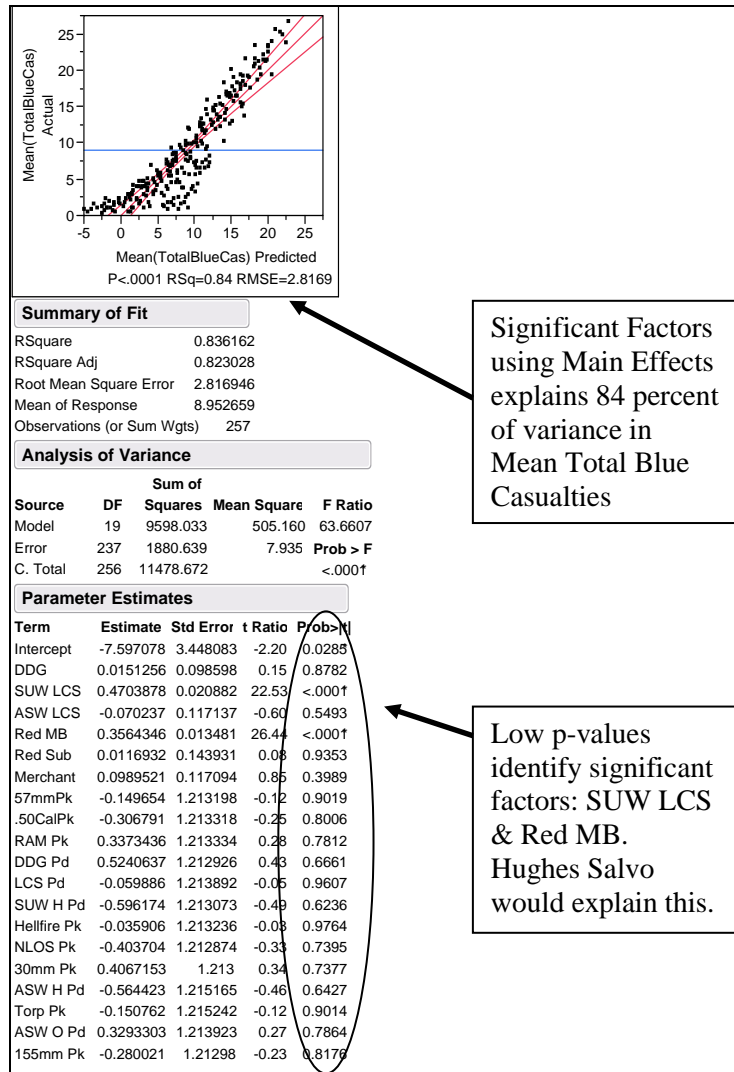

Figure 11. Regression analysis of Mean Total Blue Casualties for the SUW scenario.

This regression identifies which factors have more influence and what their contribution to the MOE is. Regression tree analysis (Figure 12), of mean total Blue casualties again shows that the missile boats have a significant impact in the SUW

scenario. It also suggests that when there are less than 25 missile boats, having less than 16 SUW LCSs produces lower mean total Blue casualties. When missile boats are greater than 25, less than five SUW LCSs and two ASW LCSs produces lower mean total Blue casualties.

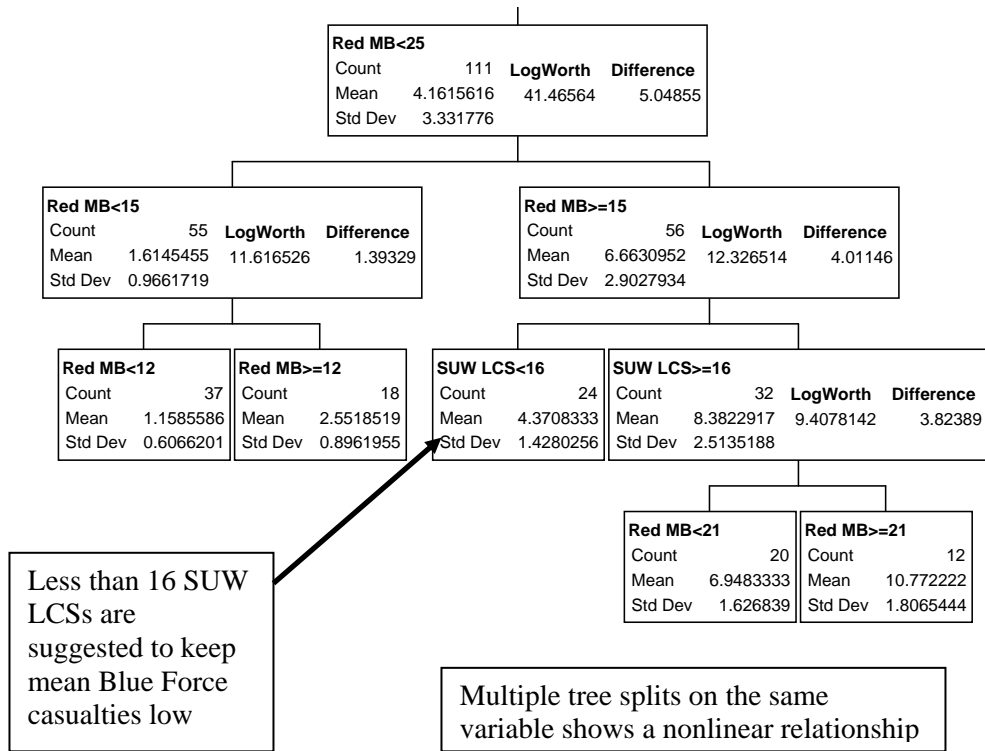

Figure 12. Left side of the regression tree for Mean Total Blue Casualties, where there are less than 25 Red missile boats.

From this initial look, the limit of 11 SUW LCSs is considered as an upper bound for the LCS employable squadron. This is considered the upper bound, as the rapid increase in mean Blue casualties accelerates beyond 11 LCSs as depicted in Figure 14. The combination of less than five SUW LCSs and two ASW LCSs are suggested to produce lower mean Blue force casualties. This is consistent with the findings LT Abbot (2008) had for his study. Figures 12 and 13 show portions of the regression tree for mean total Blue casualties that illustrate the analysis for the lower and upper bounds. The full regression tree can be founded in Appendix C.

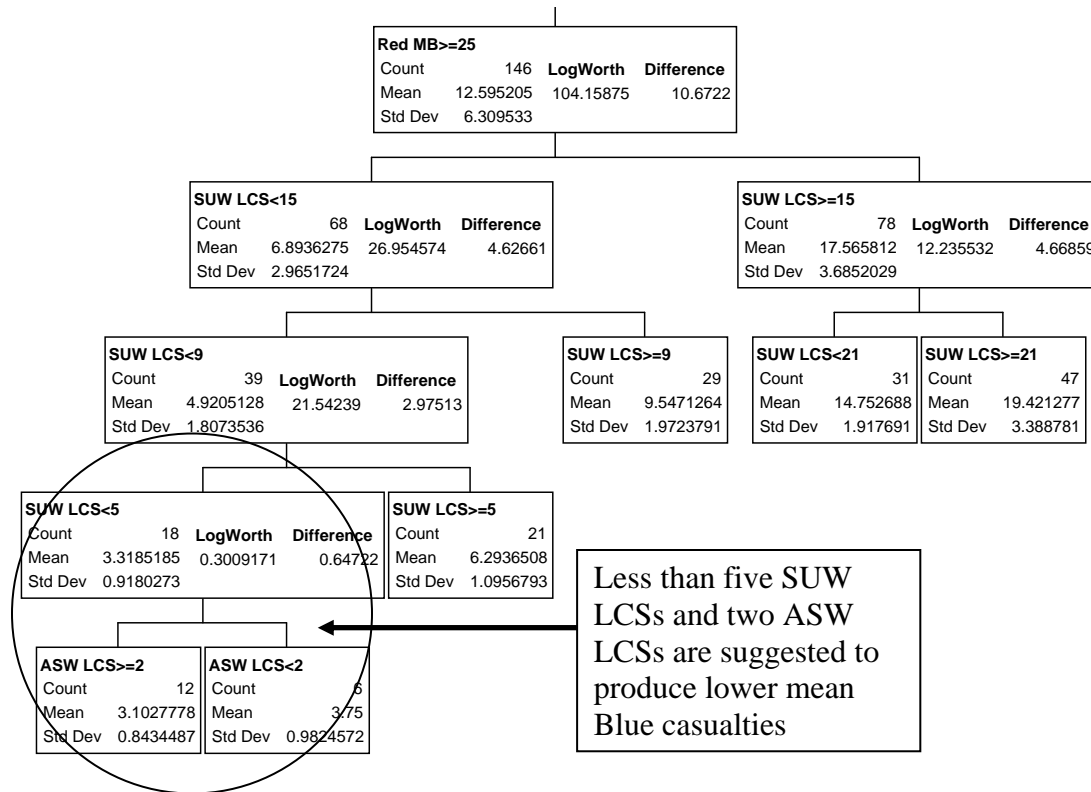

Figure 13. Right side of the regression tree for Mean Total Blue Casualties, where there are greater than 25 Red missile boats.

This represents the left side of the regression tree for mean total Blue casualties. Regression tree analysis conducts a binary split, with the lower values displayed on the left-hand side. In each split, the regression tree shows how many cases meet the best specified criteria (count), the mean of the MOE for these cases (average number of casualties), and the standard deviation associated. The LogWorth value tells us the significance of the split, providing the researcher an understanding of how JMP indicates which side has more importance in the next split. For example, in Figure 12 (the first split for less than 25 missile boats), there are 111 situations meeting this criteria, and for these 111 situations, 4.16 is the mean (average) number of Blue casualties, with a standard deviation of 3.33, using only two significant figures.

Regression tree analysis of the mean total LCS casualties produced similar results, supporting the squadron size of 5 to 11 LCSs (Appendix C). The right side of the regression tree tells a more precise story in Figure 13. When there are greater than or

equal to 25 missile boats, less than five SUW LCSs and two ASW LCSs yields lower mean total Blue casualties. In the regression tree, there is a scenario where less than nine SUW LCSs also yields lower mean total Blue casualties, but it is not as optimal and, hence, further splitting of the tree was required to get the lowest mean casualty value, with the smallest standard deviation. The take-away from this regression tree is that less Blue targets provides fewer targets for Red forces to engage, keeping Blue casualties low.

Overall, this is consistent with LT Abbott's (2008) findings in which he stated that a squadron of 6 to 10 LCSs is capable of producing lower mean total Blue casualties and mean total LCS casualties. It was discovered that 5 to 11 LCSs is a better working range within this study. However, submarines and ASW LCSs were not found to be significant in this analysis.

Regression trees are a great way to find the optimal points providing greater insight into the study. In addition to regression trees, it is also very useful to see the data plotted on X and Y planes to spot potential trends. In Figure 14, plotting mean total Blue casualties versus the number of LCSs (NumLCS) shows that mean total Blue casualties do increase over the range of 5 to 11, but at a reduced rate. Each data point, or dot, in these charts represents the mean of 30 simulated littoral combat operations. The line connects the mean value of the y-axis, either mean total Blue casualties or mean total Red casualties, for the corresponding number of total LCSs. These graphs help to identify significant trends or changes in the curve. When comparing this to the mean total Red casualties for the same range, Figure 15 shows that 5 to 11 LCSs produces at least 16.1 times as many mean Red casualties than mean LCS casualties.

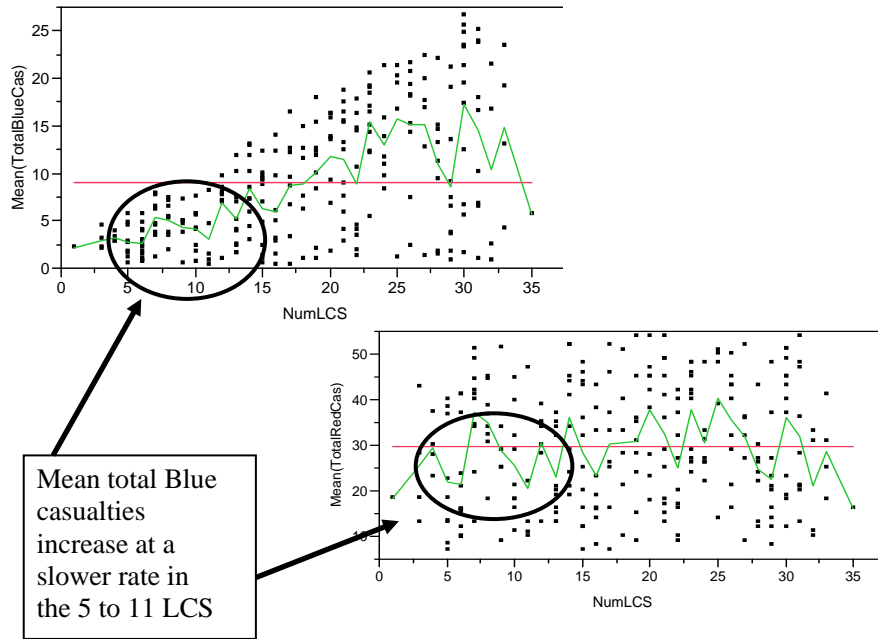

Figure 14. Graphs of Mean Total Blue Casualties and Mean Total Red Casualties vs. Number of LCSs shows the impact of an employable LCS squadron with 5 to 11 LCSs.

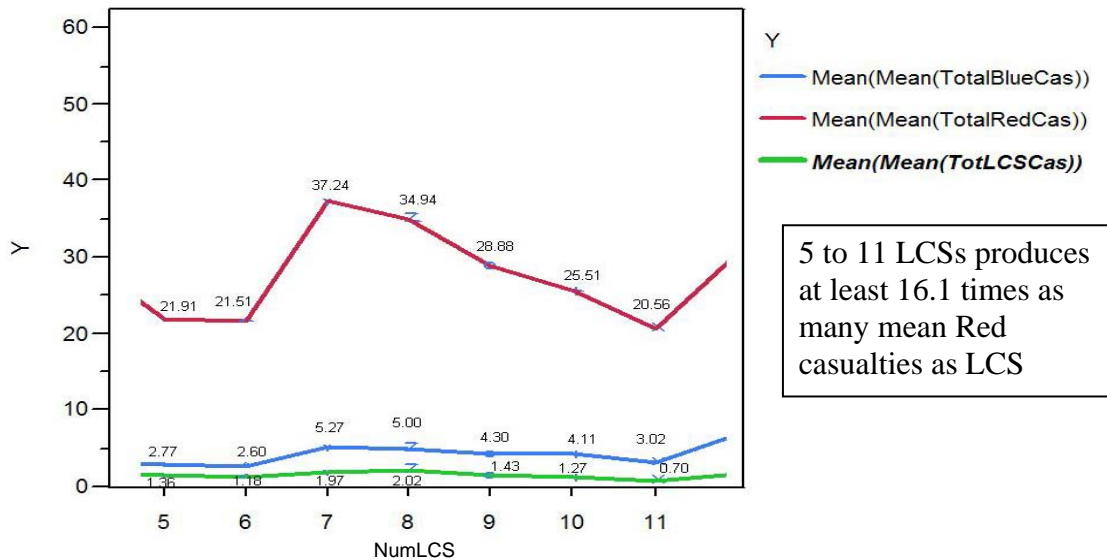

Figure 15. Graph of Mean Total Blue Casualties, Mean Total Red Casualties, and Mean Total LCS Casualties shows the contribution that a DDG has on an LCS squadron.

What is not significant, but perhaps implied, in the data is that a multimission platform can contribute to the LCS squadron. This is the first evidence of this. In LT Abbott's (2008) study, the casualty rate was much lower for Red forces, with a value

of 4.7. In that study, DDGs, or other multimission platforms, were not considered. This is a significant change, and can only be explained by suggesting that the addition of the DDG has raised the Red force casualty rate.

To gauge whether or not the regression tree was consistent, an additional regression tree analysis was performed and, in this instance, mean total Red casualties was examined. That analysis suggested that a missile boat force greater than 27 would require an LCS force of greater than five SUW LCSs, as this produces higher mean Red casualties. Again, this is consistent with earlier findings within this study. A squadron size of 5 to 11 LCSs would produce high mean Red casualties, while keeping mean Blue and LCS casualties low. The mix of the various mission packages would have to be determined, based on the need of the mission at that time. However, 3 to 4 SUW LCSs and 2 to 3 ASW LCSs, augmented by 1 or 2 DDGs depending on the mission, should be sufficient. Figure 16 shows the contribution that a multimission platform, such as a DDG, can have in an LCS squadron. Again, the effect of this addition to the force is greater than was found in LT Abbott’s study.

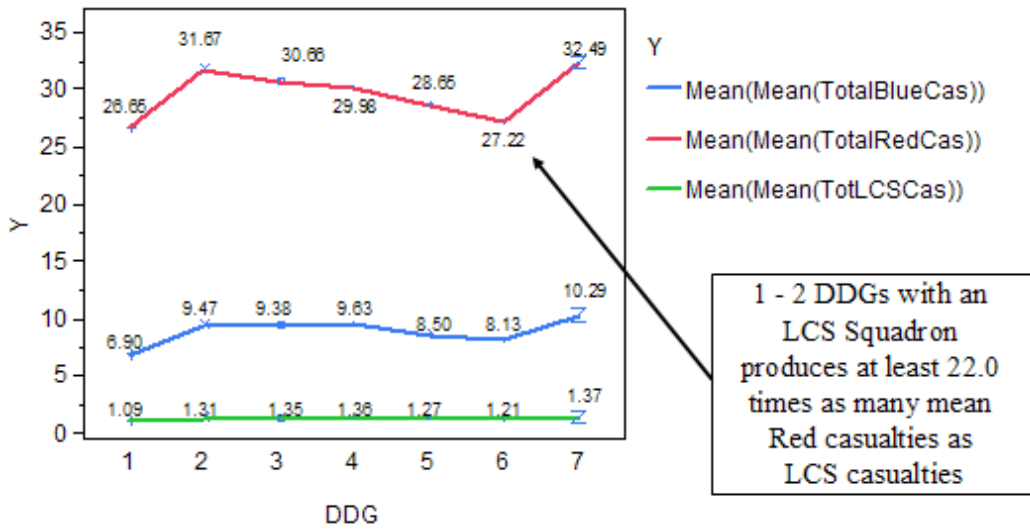

Figure 16. Graph of Mean Total Blue Casualties, Mean Total Red Casualties, and Mean Total LCS Casualties vs. number of DDGs shows the significant contribution made by the DDG in this scenario.

b. AAW Scenario

The next analysis is the AAW Scenario. However, this will not be AAW exclusively, merely the addition of AAW threat to the SUW scenario. The difference between the AAW scenario and the SUW scenario is the use of Red force aircraft providing support to friendly surface forces. This scenario will keep the Red submarine threat as a tertiary threat giving this a more robust situation. The addition of aircraft will allow the opportunity to take full advantage of the DDG and the air defense capability of the LCS via the RAM. As before, a main effects linear regression was performed in order to provide an understanding of the relationship between the MOEs and the variables. What was revealed in the analysis was that SUW LCS, DDG, and Red aircraft are statistically significant in predicting mean total Blue casualties, explaining 84 percent of the variation. In addition, the analysis also shows that while Red missile boats are important, they are just not as significant as in the SUW scenario. Figure 17 shows the regression analysis of mean total Blue casualties for the AAW scenario.

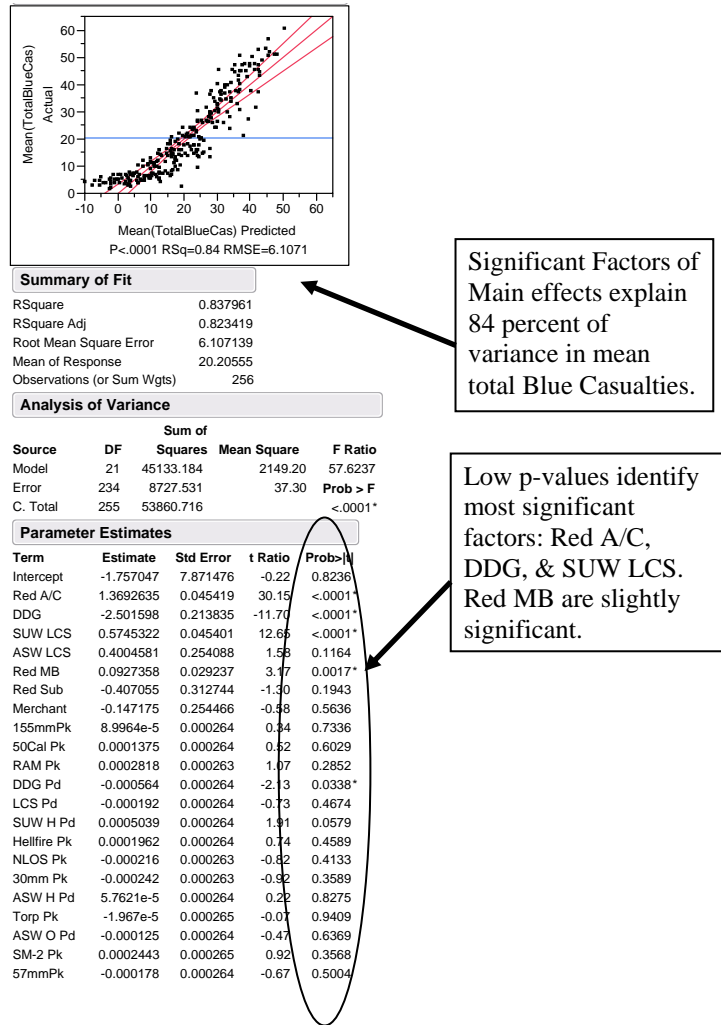

Figure 17. Regression analysis of Mean Total Blue Casualties for the AAW scenario.

It is important to point out that for this scenario, it was necessary to examine LCS, DDG, and Red aircraft casualties to gain insight to the contributing loss. Three more regression models were analyzed to examine what impacted each of these three platforms. In the case of mean total LCS casualties, the analysis demonstrated that SUW LCS, DDG, and Red aircraft are statistically significant in predicting mean total LCS casualties, explaining 82 percent of the variation. For the mean total DDG casualties, the analysis revealed that DDG, Red aircraft, and, this time, Red missile boats, are statistically significant in predicting the mean total DDG casualties, explaining 81 percent of the variation. Lastly is the resulting impact of introducing aircraft to the scenario. Since the outcome is to see how aircraft influence the battlespace, it is

important to see how aircraft contributed and what was significant. The analysis revealed that SUW LCS, DDG, and Red aircraft are again statistically significant in predicting mean total aircraft casualties, explaining 85 percent of the variation, higher than in the first analysis for Blue force casualties.

Upon determining what factors were significant in the AAW scenario, regression tree analysis was conducted. Regression tree analysis of mean total Blue casualties shows that aircraft are the most significant factor, which is what should be expected from this scenario. When there are 6 to 11 aircraft, the regression tree suggests that less than 17 SUW LCSs produce lower mean Blue casualties. The regression tree also shows that 4 to 6 DDGs produce lower mean Blue casualties when the number of aircraft is greater than 11, but less than 16. Figure 18 shows the regression tree analysis. The full regression tree can be found in Appendix C.

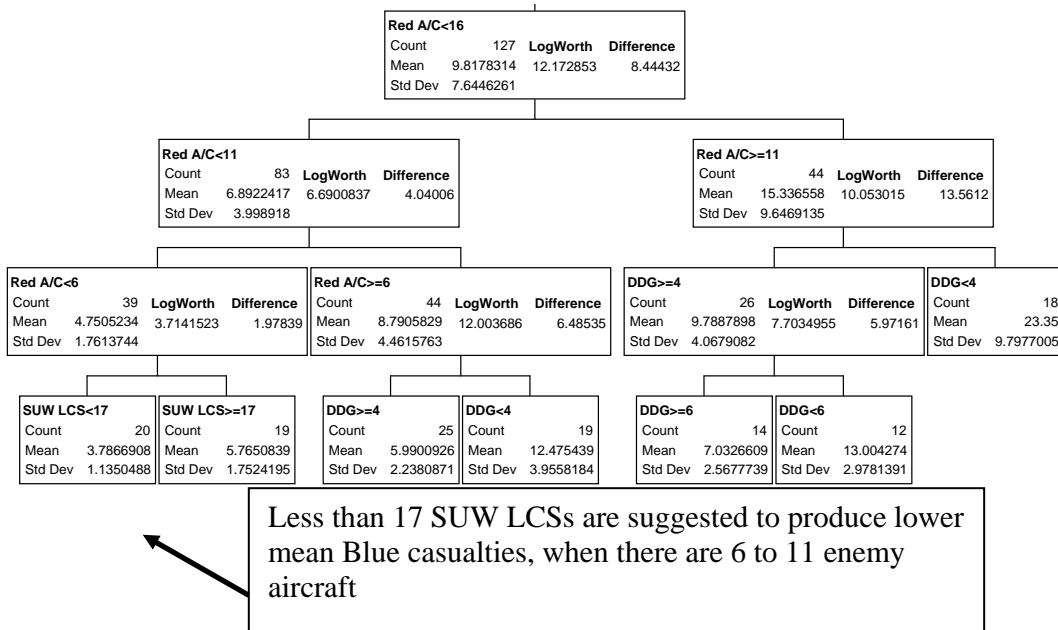

Figure 18. Portion of regression tree for Mean Total Blue Casualties for the AAW scenario.

Further regression analysis in Figure 19 shows that between 7 and 13 SUW LCSs are needed when confronting a force of Red aircraft greater than 16, thus reducing mean Blue casualties. The sharp increase is indicated in the graph in Figure 20,

which supports the increase in Blue casualties at 13 SUW LCSs and signifies that this is could be an upper limit or force threshold for the squadron.

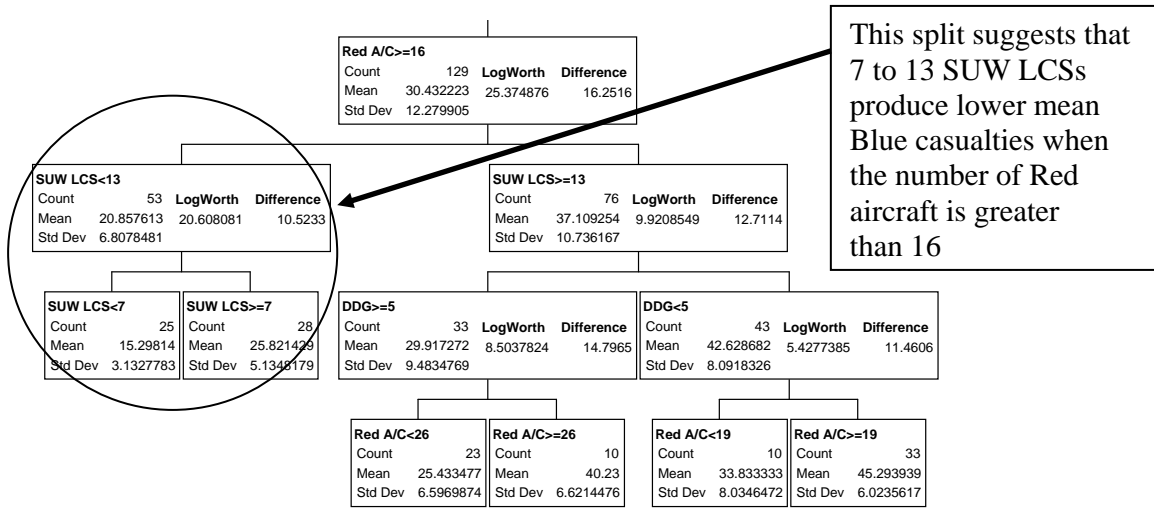

Figure 19. Portion of regression tree for Mean Total Blue Casualties for the AAW scenario.

In Figure 20, mean total Blue casualties and mean total LCS casualties increase slowly until reaching 13 Red aircraft, after which Blue force losses accelerate. Plotting the number of DDGs versus mean total Red aircraft casualties increases Red aircraft casualties, while simultaneously decreasing mean Blue casualties. DDGs have an overall positive effect against mean total Red casualties. While mean LCS casualties are increasing, they are increasing at a slower rate right before they spike.

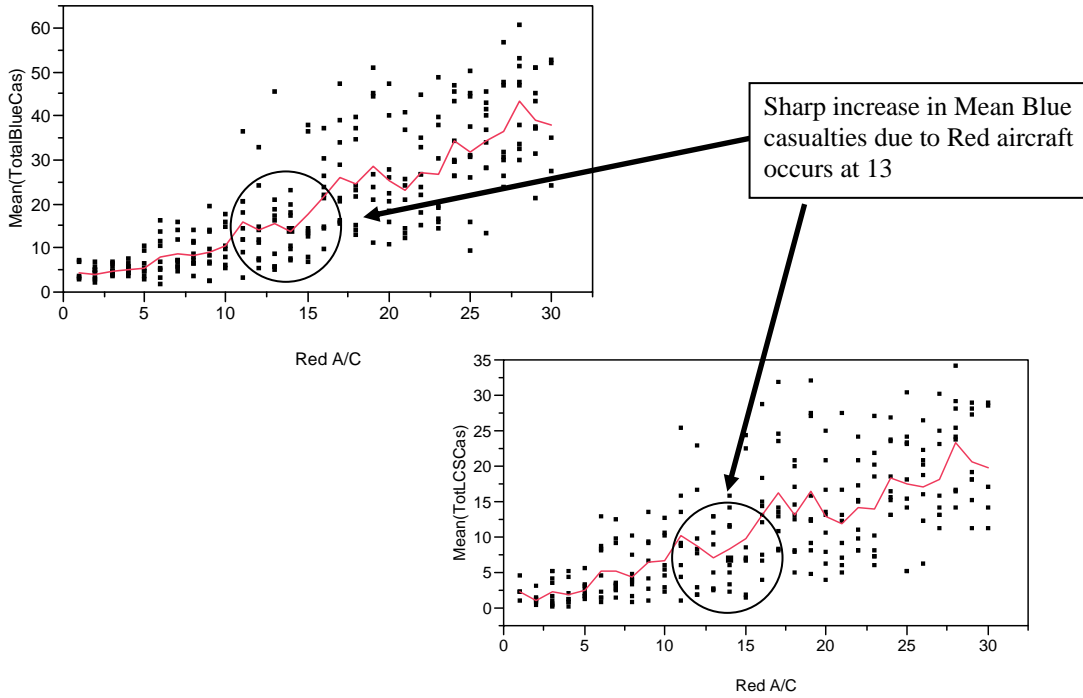

Figure 20. Graphs of Mean Total Blue Casualties and Mean Total LCS Casualties vs. Red Aircraft.

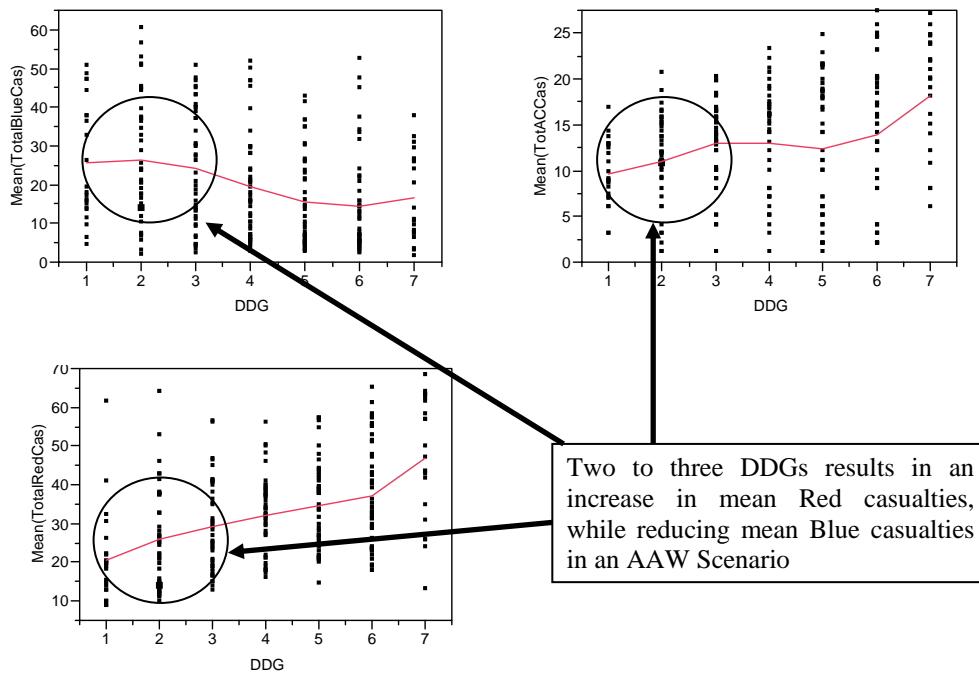

Figure 21. Graphs of Mean Total Blue Casualties, Mean Total Red Casualties, and Mean Total Red Aircraft Casualties vs. DDG.

In considering the squadron's composition for the AAW scenario, previous regression tree analysis suggested 7 to 13 SUW LCSs in order to provide lower mean Blue casualties. Adding just one more SUW LCS increases the mean total LCS casualties, but reduces mean Red casualties. The graph can be found in Appendix C. In all AAW scenario analyses, having one or more ASW LCS contributed to the increase in mean Red casualties. This suggests that while at least five SUW LCSs and two DDGs are needed in a squadron composition to produce lower mean Blue casualties in the AAW scenario, seven SUW LCSs, two ASW LCSs, and two DDGs provide the highest mean Red casualties, while staying below the 13-ship threshold where there is a sharp increase in mean Blue casualties.

c. Summary

In summary, both scenarios provide analytic support for an employed LCS squadron. The range for both scenarios falls between 5 and 13 LCSs. A composition of at least 3 to 4 SUW LCSs and 2 to 3 ASW LCSs is recommended for the SUW scenario. The addition of a DDG did not provide a significant difference in the SUW scenario. For the AAW scenario, both aircraft and DDG were significant. Thus, a squadron composition of at least five SUW LCSs, 1 to 2 ASW LCSs and one or more DDGs produced lower mean Blue casualties and higher mean Red casualties for the AAW scenario. In essence, when faced with aircraft, the DDG is needed to enhance AAW capability in an LCS squadron.

2. The Effectiveness of Blue Force Self-Defense Weapon Systems

The next question that needs to be analyzed is the success of sensors and self-defense weapon systems on overall Blue force effectiveness. Sensors and weapon systems are important systems and cannot be ignored, and their significance to the overall force effectiveness. This section examines the significance of sensors and weapon systems in both scenarios.

a. SUW Scenario

The analysis of sensors and weapon systems follows the same methods used to examine the composition of the LCS squadron. We first must understand the relationship between the variables and the MOEs. For sensors and weapon systems, the parameters used in the regression analysis are only the variables that are probabilities. In the SUW scenario, when answering the first question in the analysis, no weapons or sensors stood out as being individually significant in predicting both mean total Blue casualties and mean total LCS casualties when in the presence of SUW LCSs, ASW LCSs, DDGs, missile boats, and submarines. In the regression tree analysis performed for squadron size and composition, sensors and weapons showed no significance either. Therefore, in the absence of individual significance, we must examine the interaction or dependency that the weapons and sensors have with one other parameter in the MOE. The type of screening analysis conducted for each MOE was stepwise regression effects screening to determine when sensors and weapon systems do become statistically significant. In Figure 22, we see that the weapon systems and sensors alone are insignificant.

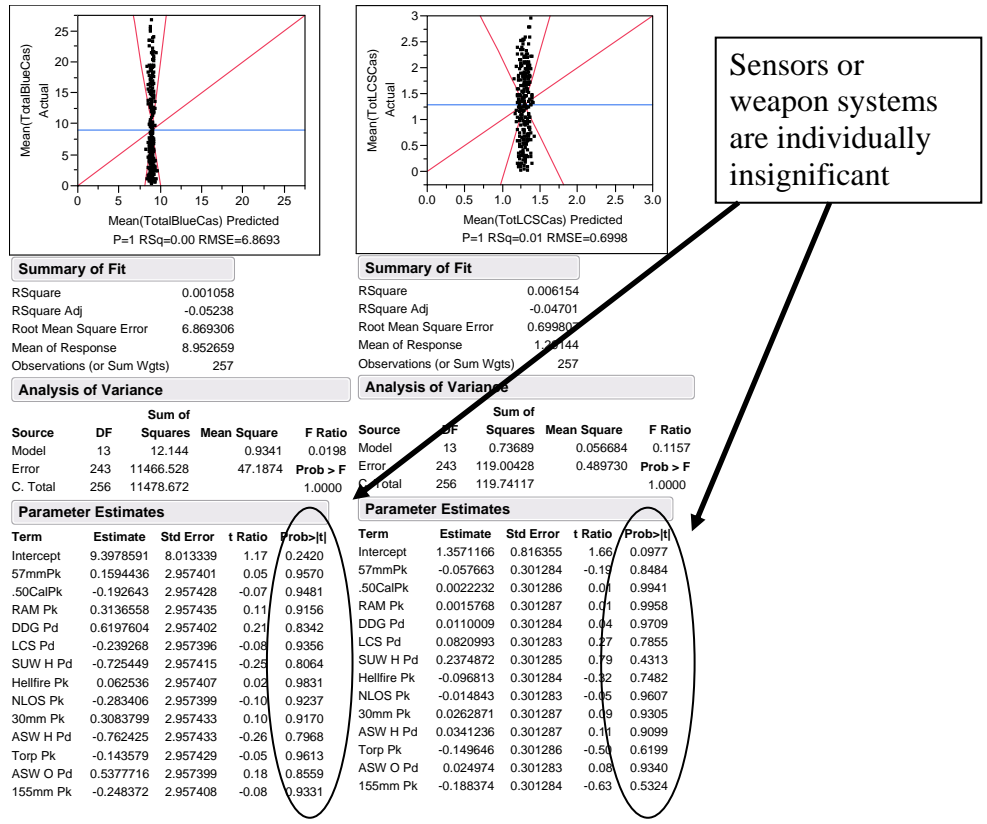
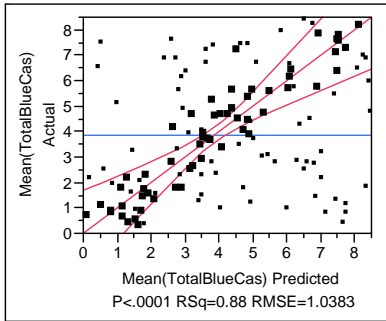

Figure 22. Regression analysis of Mean Total Blue Casualties and Mean Total LCS Casualties when considering only sensors and weapon systems for the SUW scenario.

Figure 22 shows us that a more in-depth analysis is needed to determine sensor and weapon system dependencies. Thus, a factored regression analysis was created. This interaction was factored to the second degree, allowing only two parameters to show their interdependence to one another. The results only explained four percent of the variance; therefore, a filtering of the dataset was needed. The narrowed parameters for the analysis created a subset, to focus only on the lower and upper bound of 5 to 11 LCSs and DDGs. The DDG was considered because although the analysis shows the DDG was insignificant, its sensors or weapon systems could be and, hence, the DDG was left in the analysis. This analysis suggests that sensors and weapon systems become statistically significant only in the interaction terms.

When analyzing mean total Blue casualties, the screening identifies .50Cal Pk, LCS Pd, Torp Pk, RAM Pk, ASW O Pd, and other interaction terms as statistically significant, and that they explain 88 percent of the variation. Similarly,

effects screening analysis of mean total Red casualties identifies .50Cal Pk, ASW O Pd, and other interaction terms as statistically significant, and that they explain 89 percent of the variation in mean Red casualties. These results show that in a squadron size of 5 to 11 LCSs, 50Cal Pk, LCS Pd, Torp Pk, and ASW O Pd significantly contribute to the MOEs. Figure 23 shows the regression analysis resulting from the effects screening for mean total Blue casualties over the data subset in the SUW scenario, when considering only sensors and weapon systems.



Summary of Fit

RSquare	0.881656
RSquare Adj	0.792002
Root Mean Square Error	1.038286
Mean of Response	3.846893
Observations (or Sum Wgts)	59

Analysis of Variance

Source	DF	Sum of Squares	Mean Square	F Ratio	Prob > F
Model	25	265.03394	10.6014	9.8339	
Error	33	35.57522	1.0780		
C. Total	58	300.60915			<.0001*

Parameter Estimates

Term	Estimate	Std Error	t Ratio	Prob> t
Intercept	-3.091963	2.757343	-1.12	0.2702
57mmPk	-0.898056	1.283746	-0.70	0.4891
.50CalPk	7.5106985	1.782877	4.21	0.0002*
RAM Pk	2.2388727	1.042004	2.15	0.0391*
DDG Pd	-1.285542	1.269742	-1.07	0.3187
LCS Pd	-3.964431	1.19929	-3.31	0.0023*
SUW H Pd	-1.853117	1.216222	-1.52	0.1371
NLOS Pk	-0.217067	1.196167	-0.18	0.8571
30mm Pk	-1.709717	1.114497	-1.53	0.1345
ASW H Pd	0.9479953	1.074615	0.88	0.3841
Torp Pk	5.7708208	1.764615	3.27	0.0025*
ASW O Pd	3.3505584	1.180808	2.84	0.0077*
155mm Pk	-0.211725	1.115205	-0.19	0.8506
(57mmPk-0.74322)*(RAM Pk-0.75764)	-35.08429	8.4661	-4.14	0.0002*
(57mmPk-0.74322)*(ASW O Pd-0.74181)	91.566172	14.59005	6.28	<.0001*
(57mmPk-0.74322)*(155mm Pk-0.7538)	47.773875	13.0835	3.65	0.0009*
(.50CalPk-0.75829)*(SUW H Pd-0.7549)	19.095418	9.044618	2.11	0.0424*
(.50CalPk-0.75829)*(NLOS Pk-0.75758)	-57.88989	7.599699	-7.62	<.0001*
(.50CalPk-0.75829)*(30mm Pk-0.74)	34.722977	8.275917	4.20	0.0002*
(.50CalPk-0.75829)*(155mm Pk-0.7538)	47.155738	10.68466	4.41	0.0001*
(RAM Pk-0.75764)*(NLOS Pk-0.75758)	31.419918	7.448421	4.22	0.0002*
(DDG Pd-0.7398)*(ASW H Pd-0.7641)	38.868407	10.90952	3.56	0.0011*
(LCS Pd-0.7619)*(SUW H Pd-0.7549)	-48.31175	8.850074	-5.46	<.0001*
(SUW H Pd-0.7549)*(ASW O Pd-0.74181)	40.372206	7.481331	5.40	<.0001*
(NLOS Pk-0.75758)*(ASW O Pd-0.74181)	-32.45948	8.953522	-3.63	0.0010*
(Torp Pk-0.74136)*(ASW O Pd-0.74181)	-61.73817	12.55899	-4.92	<.0001*

Identified as individually significant .50Cal Pk, LCS Pd, Torp Pk, RAM Pk, and ASW O Pd

Identified (57mm Pk*Ram Pk) and many interaction terms as statistically significant

Figure 23. Regression analysis resulting from effects screening of Mean Total Blue Casualties in the SUW scenario, when considering only sensors and weapon systems.

b. AAW Scenario

The AAW scenario will be analyzed in much the same way as the SUW scenario. A regression analysis was performed to gain insight into sensors and weapon systems significance in predicting mean total Blue casualties and mean total Red casualties. The results are shown in Figure 24. Again, as with the SUW scenario, the regression analysis reveals that there is no individual significance of the weapon systems or sensors.

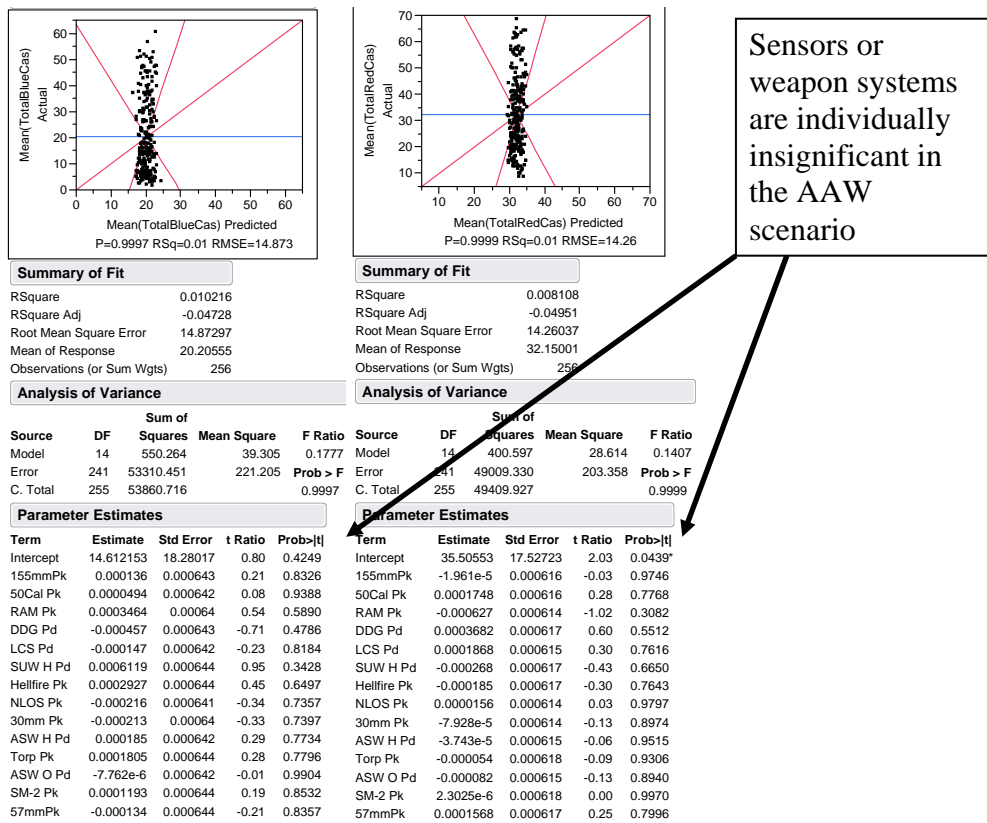

Figure 24. Regression analysis of Mean Total Blue Casualties and Mean Total Red Casualties, when considering only sensors and weapon systems for the AAW scenario.

Thus, a filter of the complete data set was performed with 5 to 13 LCSs and five total DDGs. This comes from the results of the regression tree analysis. In Figure 25, the effect screening of the filtered data subset shows statistical significance among individual sensors and weapon systems in the AAW scenario. When analyzing

mean total Blue casualties, effects screening identifies 155mm Pk, SM-2 Pk, 57mm Pk, ASW O Pd, and Hellfire Pk as statistically significant, and that they explain 44 percent of the variation in that MOE.

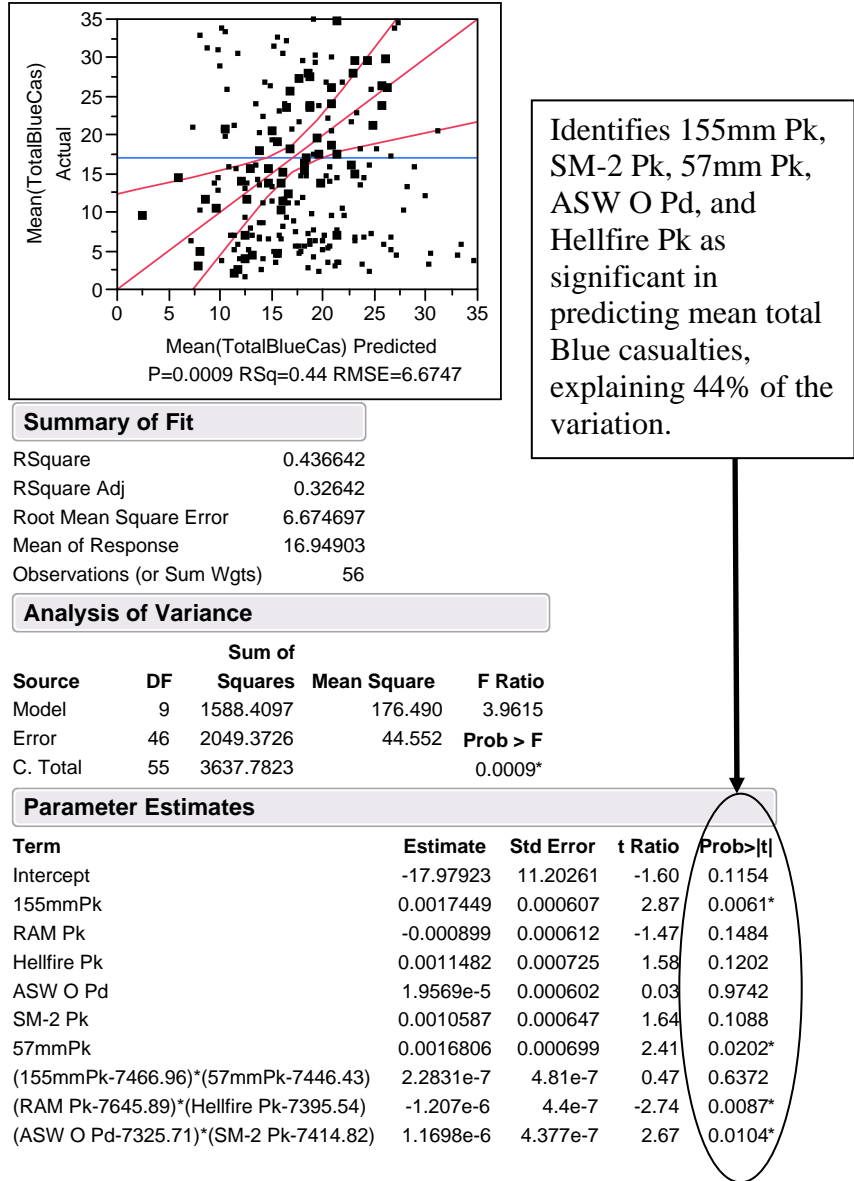

Figure 25. Regression analysis resulting from effects screening of Mean Total Blue Casualties and Mean Total Red Casualties, when considering only sensors and weapon systems for the AAW scenario.

Effects screening of the data subset shows significance among individual sensors and weapon systems. For the mean total Red casualties, the analysis identifies

.50Cal Pk, NLOS Pk, SM-2 Pk, RAM Pk, ASW O Pd, Hellfire Pk, Torp Pk, ASW H Pd, and other interaction terms as significant, and that they explain 69 percent of the variation in that MOE for mean Red casualties.

These results show that in a squadron of LCSs and DDGs, 155mm Pk, SM-2 Pk, 57mm Pk, and NLOS Pk significantly contribute to the MOEs. Figure 26 shows the regression analysis resulting from the effects screening for mean total Red casualties over the data subset in the AAW scenario, when considering only at sensors and weapon systems.

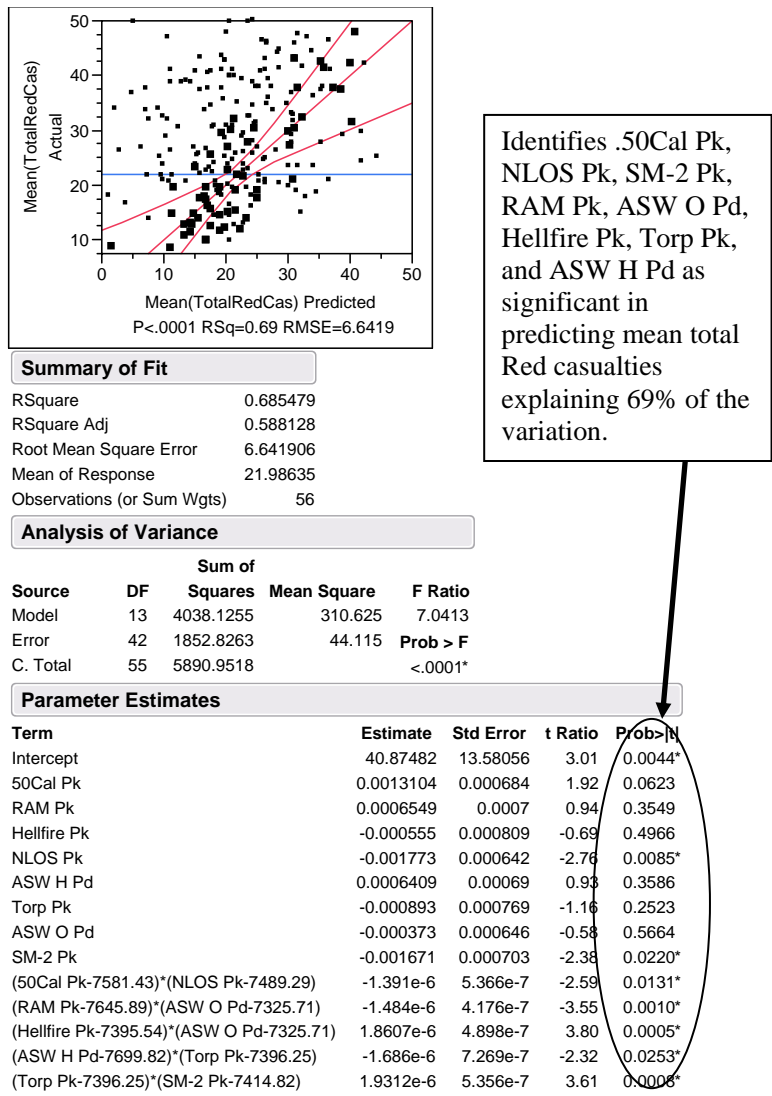

Figure 26. Regression analysis resulting from effects screening of Mean Total Red Casualties, when considering only sensors and weapon systems for the AAW scenario.

c. Summary

This section has shown that in each scenario, sensors and weapon systems contribute at various levels to the MOEs. In the presence of others, none of the sensors or weapons are individually identified as statistically significant, suggesting that previous numbers play a larger role in impacting the MOEs. While .50Cal Pk is significant in the SUW scenario, SM-2 Pk is significant in the AAW scenario after the data has been filtered to the specified size of the force. The DDG makes a large contribution to the AAW scenario, whereas it plays a minor role in the SUW scenario. While it is important for the sensors and weapon systems to be identified as statistically significant, the results show that sensors and weapon systems do contribute to the MOEs during the interaction with others.

D. FURTHER INSIGHTS

Further insights come as a result of conducting the data analysis. These serve as the lessons learned from this study and what the data tells us. Often these new insights can further be reviewed in follow-on research. This section outlines those insights and the resulting impacts.

1. LCS Squadron Force Reduction in the SUW Scenario

When conducting the analysis for size and composition of the LCS squadron in the SUW scenario, it was discovered that missile boats and not submarines contributed the most to mean total Blue casualties and mean total LCS casualties. These results suggest that the missile boat threat has higher priority in the battlespace in order to reduce Blue force casualties. However, since the ever-increasing spread of diesel submarine technology, it would be wise for the LCS squadron to be configured to handle that threat. The research here indicates that 2 to 3 ASW LCSs would be sufficient to handle the task. The addition of the DDG to the force drives down the requirement for more LCSs and, hence, reduced squadron size.

2. The Advantages of Multimission Platforms in an LCS Squadron

The analysis from the AAW scenario clearly points out the importance of having sufficient capability in this mission area. Multimission combatants like the DDG-1000 bring multilayer defense that the LCS cannot deliver. The analysis clearly demonstrated, as it was predicted, that aircraft are the most important threat in an AAW environment. Although in the SUW scenario, force size was slightly reduced, in an AAW scenario, numbers are an advantage and especially platforms that can reach out and engage aircraft at longer ranges. The LCS lacks that punch and is therefore vulnerable. The regression tree analysis clearly shows the need for higher numbers in both SUW LCSs and DDGs. However, further analysis suggests that too large a force accelerates Blue force casualties.

3. Limitations of the Littoral Combat Ship (LCS)

With the development of the LCS, its ability to engage multiple threats is limited. The LCS relies on numbers and mission modules to augment abilities already inherent in larger warships. The ability of the LCS to handle small boat swarms in these scenarios is good and provides valuable support to the ship's design. However, stand-off, air-launched weapons or those from the sea are its Achilles heel, which leaves the LCS vulnerable. In the absence of an AAW-capable platform, the addition of DDGs to the squadron provides that credible AAW defense. In short, the analysis shows that the presence of DDGs in an LCS squadron drives down Blue force casualties, while raising Red force casualties.

THIS PAGE INTENTIONALLY LEFT BLANK

V. CONCLUSIONS AND RECOMMENDATIONS

With every new ship building program comes both questions and assumptions.

LT Ben Abbott, USN

A. SUMMARY OF FINDINGS

The littoral battlespace requires focused capabilities in greater numbers to assure access against asymmetrical threats. This is the purpose of the LCS. The multimission DDG-1000 Zumwalt is designed for sustained operations in the littorals and land attack, and will provide a forward presence and deterrence. Together, these ships present an affordable balance between force size and capabilities to meet current and projected threats, helping the United States Navy defeat growing littoral, or close-to-shore, threats and providing access and dominance in coastal water battlespace.

This study set out to provide critical insight into the employment of an LCS squadron augmented by a multimission warship, in a stressful operational environment. Through the use of realistic scenario simulations, this study produced detailed analysis regarding the size, composition, and effects of sensors and weapon systems of this squadron. It also provided a framework for future use of agent-based models, such as MANA, in exploring similar or related topics.

B. QUESTIONS ADDRESSED IN THIS STUDY

A summary discussion of the study questions are addressed in the following.

1. **How many LCSs should there be in a squadron when adding multimission warships?**

Through the process of careful data analysis using several regressions, regression with main effects screening and regression trees provided a view of LCS squadron size and composition. The driving force behind this study was to see if multimission combatants, such as the DDG-1000, would drive down the numbers needed for LCSs in a squadron. The result was that it did, indeed, lower the requirement. LT Abbott's (2008)

study said that in the three primary mission areas tested (SUW, ASW, and MIW) 6 to 10 LCSs produce lower mean casualties for both the Blue force, and LCS specifically, while producing higher mean Red casualties in each of the warfare areas. When one or more DDGs were added to the squadron, SUW LCS numbers were reduced between 1 and 2 for SUW warfare missions. Overall, the SUW scenario required 5 to 11 LCSs in order to keep Blue force casualties low. For the AAW scenario, an area not previously explored by other studies, the force size was slightly larger, emphasizing an LCS footprint of 7 to 13 LCSs. Specifically, the study emphasized that 5 to 7 SUW LCSs, and the addition of several DDGs, were necessary to counter the AAW threat. ASW LCSs were reduced down to 1 or 2, simply because of the overlapping capabilities that the ASW LCS brings to the squadron. Overall, a DDG brings multimission capabilities that are not inherent in the LCS, especially in terms of the AAW threat.

2. What is the impact of the reduction of an LCS squadron containing traditional multimission platforms in an environment that may contain multiple threats?

In this study, when presented with an AAW/SUW combined threat, DDGs were significant and provided that stand-off, air defense capability. The LCS can defend itself against air threats, but not against those aircraft with stand-off weapons that can operate beyond the range of its RAM system. The AAW threat modeled the Soviet-built SU-24 Fencer, carrying weapons capable of hitting the LCS outside of its weapons ranges. In addition, this study clearly shows the significance of the SM-2 missile and its ability to hit air threats at greater distances than what the LCS can provide. Further analysis recommends the following LCS squadron composition: for SUW scenarios, 3 to 4 SUW LCSs, 2 to 3 ASW LCSs, and 1 or 2 DDGs; the AAW scenario requires 5 to 7 SUW LCSs, 1 to 2 ASW LCSs, and 1 to 3 DDGs. This variance in squadron size allows the decision maker to decide what is important in the mission. It is important to note that in this analysis, ASW was always a threat, even when it was a tertiary concern to the squadron. In all cases, a squadron size beyond 13 ships is not recommended, as the study reveals a significant increase in mean Blue force casualties with decreasing mean Red force casualties.

3. How effective are the force self-defense weapon systems with regard to enabling completion of the given mission?

Each ship design has its specific purpose and with it, the technology applied to allow it to complete those assigned missions. For the LCS, it is littoral warfare—the capability of bringing a flexible, yet measurable, response against similar threats in close to enemy territory, where a more traditional asset might be constrained. The DDG-1000 is designed for multimission threats, including in areas of littoral warfare, where a graduated response can be applied and at greater distances than current assets can provide. Each warship has different weapons and sensors: the LCS is designed for close-range engagements with some Over-the-Horizon (OTH) capability; and the DDG-1000 is designed for multiple range threat detection and engagement, to include asymmetrical threats presented by small, yet capable, missile boats.

Through this analysis, using multiple regressions, effects screening, and regression trees, this study shows that sensors and weapon systems play a more significant role in the AAW scenario than the SUW scenario. For the SUW scenario, numbers were the primary mover of the data. In the AAW scenario, standout systems such as the SM-2 Pk, 155mm Pk, 57mm Pk, ASW O Pd, Hellfire Pk, and other interactions between sensors and weapons were significant in predicting mean total Blue casualties, explaining 44% of the variation in the MOE. The number was even higher for mean total Red casualties, explaining 69% of the variation in the MOE. However, it is worth noting that the weapons themselves generally were insignificant in terms of the overall scenario. The weapons were significant when the data was filtered down to the subset of the expected squadron size. While it is clear that the variation is not high and the numbers are imprecise for thresholds for most of these systems, this study does show that sensors and weapon systems play a significant role in predicting the MOEs.

C. FURTHER INSIGHTS FROM THE DATA

In addition to addressing the research questions, this study produced further insights into the use of an employed LCS squadron. This section briefly summarizes these insights.

1. Significance of Early Detection and Force Communication

In MANA, forces are able to communicate with one another and pass detection and classification information to the overall force. This presents an advantage, especially when presented with a numerically superior enemy force. This was explored in MANA and through repeated observations of the scenario interaction, evidence of targeting information being passed by both Red and Blue forces became known. The contributing evidence does not stand out in the analysis, but is noticeable in the associated higher casualty rate by both forces. History tells us that when a force has information about the enemy first, they have an advantage. In the AAW scenario specifically, Red aircraft had the ability to combine efforts to detect, classify, and engage threats, this was evident in the behavior of the agents. For Blue forces, SUW and ASW helicopters were able to engage enemy missile boats sooner when they were detected and classified by friendly sensors, especially by those of the DDG-1000's SPY-3, with its longer ranges.

2. Limitations on the AAW Mission for LCS

The regression tree analysis of the AAW scenario displays an inconsistency in the handling of enemy aircraft. Suggesting that the numbers of LCSs for high levels of aircraft and low numbers of LCSs when the threat is large gave rise to the thought that there may be a limit to the number of aircraft that a squadron of LCSs can handle without support. In this case, 13 LCSs was an upper bound when confronting aircraft greater than 16, which was defined in this analysis. This suggests that this LCS force needs multimission platform support and further justifies the need of including at least one DDG in the mix, in order to reduce mean total Blue force casualties.

3. The Benefit of Simulating Operations Using MANA

The benefit of computer simulation cannot be overemphasized in its ability to simulate numerous operations and, in this case, the littoral operations, without placing our forces at risk. A great deal of simulations were executed in a short amount of time, with little setup, creating a large number of possible outcomes for review. The analysis

of the results provides the lessons learned and helps improve CONOPS and TTPs for these combat environments. This also provides costs savings in time, money, and manpower conducted in real life. Through this type of experimentation, valuable insight can give the decision maker a close approximate answer in much less time than those of more complex simulations. MANA may have been designed for use by land forces, but its design and foundation can be adapted for a much broader range of applications.

4. The Importance of Filtered Data for Analysis

During the course of this study, analysis was performed to determine cause and effect for a given situation. The sheer numbers of a force were easily handled; however, when determining the impact of weapons and sensors in this model, it was not so simple. After careful observation, filtering of the data down to what the numbers support in the regression trees provided genuine insight into that force's capability. Initially, the lack of significance created a pause, wondering if the scenario was modeled correctly. Once the data was filtered into a subset, only then was the significance realized for the given scenario. Remember that the majority of the weapons and sensors did not stand out themselves; the majority stood out when they interacted with others. This provided more realism to the scenario. Rarely does any one system operate independent of the others; it is usually in concert with all of them. Thus, filtering the data was used and it aided greatly in understanding the applicable forces' ability to deal with the threat presented.

The results of this study support the following recommendations:

- In order to produce low mean Blue casualties and high Red casualties, it is recommended that the employed LCS squadron consist of 5 to 11 LCSs, with 1 to 2 DDGs. DDGs provide overlapping capabilities and a credible AAW deterrent.
- When deploying an LCS squadron for an SUW mission in the absence of all other threats, it is recommended that a composition of 3 to 4 SUW LCSs, 2 to 3 ASW LCSs, and one DDG be used. At least one ASW LCS should always accompany an LCS squadron as a safeguard against unknown submarine threats.

- When deploying an employed LCS squadron for an SUW mission that may include an AAW threat, it is recommended that a composition of 5 to 7 SUW LCSs, 1 to 2 ASW LCSs, and 1 to 3 DDGs be used.
- In situations where information regarding the disposition of enemy forces is uncertain, it is recommended that the compositional rule of thumb be five SUW LCSs, one ASW LCS, and two DDGs. This allows for overlapping of capabilities without compromising the force. This would also apply when situations may contain a credible submarine threat.
- The use of simulation and experimentation helped provide valuable information that was timely and insightful for platforms not yet certified for combat. It is recommended that these techniques be used in future naval research to guide the development and deployment of new technologies.
- The benefits of using an adaptable, yet easy-to-learn, simulation tool like MANA cannot be overemphasized. The use of MANA for this study allowed for quick turn around results, which, under normal conditions and the use of more robust simulation tools, would have taken months instead of days or weeks. Tools such as this give commanders a good approximation of performance, sufficient to make decisions in a timely manner.

D. TOPICS FOR FURTHER STUDY

While conducting this study, the following topics were identified for further research:

- Analysis of a multiple threat environment on Blue force casualties and mission effectiveness.
- Effects of communication and data links across Blue forces, and its effects on both Blue force and Red force casualties and mission effectiveness.
- Analysis of the impact of a mixed squadron, containing LCS and multimission platforms used against shore targets in support of surface platforms, on Blue force casualties and mission effectiveness.
- The modeling and simulation of shore missile threats against Blue forces operating in a littoral or near littoral combat environment.
- Focused analysis of the sensors and weapon systems under development in order to provide recommended thresholds.
- The modeling and simulation effects of indirect fire of surface-to-surface missiles against naval targets.

- The modeling and simulation effects of stealth technology used in air and naval combat.
- Analysis of total force attrition and survival rates against highly maneuverable surface threats.
- The development and inclusion of coastal and ocean geography for MANA to provide realism to naval scenarios.
- Analysis and effects of sea clutter on naval force targeting against small, highly maneuverable surface threats.
- The development of cruise missile agents in MANA that allow for the use of point defense systems.
- The development of cruise missile agents to be deployed aboard other agents. This would allow for the creation of cruise missile launchers for either land or sea platforms.
- Further development of MANA sensors to allow for the agent to distinguish between air and surface threats.

THIS PAGE INTENTIONALLY LEFT BLANK

APPENDIX A. PERSONALITIES AND CAPABILITIES OF MANA AGENTS

The information in this appendix is provided as a reference for the reader and describes the personality of each Blue force and Red force agent used in the MANA model (Abbott 2008). Only the DDG-1000 and Red aircraft were added to the original scenario.



Red Force Missile Boats

Weapon	Range	Pk	# Rounds
C-802 SSM	66 nm	.75	4
30 mm Gun	1 nm	.7	3000

Sensors and Speed: Basic surface search with a detection range of 20 nm, and classification range of 12 nm. Missile boats transit at a speed of 8 knots, attack at 40 knots, and can travel at 15 knots when injured.

Personality Summary: Missile boats commence attack as a group once they detect any blue forces. When attacked by blue, they disperse from the area receiving fire. Their smaller sensor range does not allow them to capitalize on their long range missile capability. Once an enemy is detected they pursue. Number of missile boats is varied through the Nearly Orthogonal Latin Hypercube (NOLH).

Source: Abbott 2008

WWW.NPS.EDU



Red Force Submarines

Weapon	Range	Pk	# Rounds
Torpedo	10 nm	.75	18

Sensors and Speed: Submarine is assigned a detection range on surface targets of 20 nm but cannot classify until 8 nm. Submarines are assigned an attack speed of 15 knots and a patrol speed of 6 knots. Due to the intended abstractness of this study, no concern was given to the various depth profiles normally associated with ASW problems.

Personality Summary: Enemy Submarines lie in waiting for Friendly forces entering the channel. Once an enemy is detected they pursue and use torpedoes. If they are fired upon they commence evasion procedures by taking randomly drawn courses away from blue forces. Number of enemy submarines is varied through the NOLH.

Source: Abbott 2008

WWW.NPS.EDU



Red Force Aircraft

Weapon	Range	Pk	# Rounds
C-802 ASM	66 nm	.75	4
AA-11 Missile	12 nm	.90	2
Gsh-6-23mm Gun	1 nm	.90	500

Sensors and Speed: The Aircraft are assigned to provide SUCAP for the missile boat force. Aircraft will patrol and engage both air and surface targets. Aircraft are assigned a classify and detection range of 120 nm. Aircraft are assigned an attack speed of 300 knots and a patrol speed of 200 knots.

Personality Summary: Modeled after the Su-24 Soviet made Fencer. Enemy Aircraft will provide Surface Combat Air Patrol (SUCAP) for the missile boat force. The purpose is to provide a multi-threat attack on any Blue Forces that enter the channel. Once an enemy is detected the aircraft engage any surface assets with anti-ship missiles. For any air assets the aircraft will engage with Soviet built AA-11 air-to-air missiles. Number of enemy aircraft is varied through the NOLH.

WWW.NPS.EDU



Merchant Traffic

Sensors and Speed: Merchant traffic is able to detect and classify targets at 20 nm. Due to the importance of timely delivered goods and fuel economy, Merchants always travel at 20 knots. Anchored merchants remain anchored throughout the scenario.

Personality Summary: Merchant traffic is used in the model as a realistic source of surface clutter complicating the operational picture for both red and blue. Neither the friendly forces nor the enemy forces have an interest in investigating, impeding, or attacking merchant traffic. Merchants are able to be attacked and no consideration for their safety is taken into account by either side when engaging the enemy. The number of Merchants will be varied through the NOLH.

Source: Abbott 2008

WWW.NPS.EDU



DDG-1000 Zumwalt Class

Weapon	Range	Pk	# Rounds
Mk 110 57mm	15 nm	NOLH	500
155mm(62 Cal) AGS	15 nm	NOLH	500
Standard Missile	75 nm	NOLH	40

Sensors and Speed: DDG detection and classification are linked because there will be a probability associated with its detection. DDG is assigned a detection range of 200 nm and its Probability of Detection will be varied through the NOLH with a range of .5 - 1.0. DDG has a transit speed of 20 knots, and an attack speed of 30 knots. If injured, DDG will travel at a speed of 12 knots.

Personality Summary: The SUW Scenario is designed to model a LCS Squadron with the DDG added. The DDG is to provide situational awareness for the squadron by maximizing all of its sensor (AEGIS SPY-3) and weapons capabilities. Upon commencement, DDG will follow an assigned PIM into the channel. Upon enemy detection, DDG will engage and destroy its objective. Once the enemy is neutralized, DDG will return to PIM. Since the DDG is a multi-mission platform, a DDG will pursue threats associated with both its SUW and AAW mission. It will not pursue, or engage a submarine. This task is assigned to the ASW LCS in the squadron. The number of DDG will be varied through the NOLH.

WWW.NPS.EDU



Weapon	Range	Pk	# Rounds
NLOS	22 nm	NOLH	60
Mk 3 57mm	9 nm	NOLH	500
30 mm	3 nm	NOLH	3000
RAM	10 nm	NOLH	21

Sensors and Speed: For LCS detection and classification are linked because there will be a probability associated with its detection. LCS is assigned a detection range of 50 nm and its Probability of Detection will be varied through the NOLH with a range of .5 – 1.0. LCS has a transit speed of 20 knots, and an attack speed of 40 knots. If injured, LCS will be able to travel at its transit speed.

Personality Summary: The SUW Scenario is designed to model a LCS Squadron transiting a channel to clear it of any surface threats. Upon commencement, SUW LCS are following assigned PIM into the channel with an embarked MH-60R airborne. Upon enemy detection, squadron will detach LCS gaining detection and order pursuit with a kill objective. Once the enemy is neutralized, LCS will return to PIM. Since LCS is a focused mission platform, a SUW LCS will not pursue anything other than a surface threat (i.e. it will not pursue, and cannot detect, a submarine). The number of SUW LCS will be varied through the NOLH.

WWW.NPS.EDU

Source: Abbott 2008



Weapon	Range	Pk	# Rounds
Hellfire (MH-60R)	5 nm	NOLH	8

Sensors and Speed: The MH-60R is assigned a detection range of 75 nm and its probability of detection will be varied through the NOLH with a range of .5 – 1.0. The UAV will have a sensor range of 20 nm and its probability of detection will also be varied through the NOLH with a range of .5 – 1.0. The MH-60R transits at an operational speed of 144 knots, and the UAV will transit at 80 knots.

Personality Summary: The assumption is that the LCS will operate with its MH-60R airborne as opposed to the UAV. This being the case, each LCS will have their MH-60R airborne at scenario start. Modeling an initial use of a UAV due to a MH-60R being down because of maintenance is still being considered, but may be left for further research. The MH-60R follows the LCS PIM in station with LCS. Once the MH-60R detects an enemy it will pursue but will maintain a standoff distance of 20 nm until LCS is able to close, due to the short reach of its weaponry. Once LCS has closed the MH-60R, the MH-60R will approach the enemy with the LCS. Since this MH-60R is assigned to an SUW LCS, it will not pursue or attack anything other than a surface threat. Each SUW LCS is assigned 1 SUW MH-60R.

To model the loss of a MH-60R due to combat, the MH-60R is given 100 per cent concealment when it is injured and its sole desire is to find a friendly platform. Once a friendly platform is found, its concealment is returned to 0 per cent and its MH-60R attributes are replaced with those of the UAV. Due to the MH-60R standoff distance this option is not exercised very often.

WWW.NPS.EDU

Source: Abbott 2008



ASW LCS

Weapon	Range	Pk	# Rounds
Mk 3 57mm	9 nm	NOLH	500
30 mm	3 nm	NOLH	3000
RAM	10 nm	NOLH	21
.50 Cal MG	1 nm	NOLH	5000

Sensors and Speeds: With regards to sensors and speed, the ASW LCS is no different than the SUW LCS.

Personality Summary: The ASW LCS is in escort mode for this scenario, thus it is not patrolling a barrier and the SUW LCS is not necessarily following behind the ASW LCS (positions are randomized within the friendly start box at problem start). ASW LCS is assigned the same PIM as SUW LCS. Once an enemy is detected it will pursue. While the ASW LCS has weaponry to engage both surface and subsurface contacts, it will engage enemy submarines with a priority over enemy surface threats. Further, the enemy submarine engagement will be conducted with the MH-60R. Since the ASW LCS does not have a way to deliver an ASW weapon, it is assigned a 10 nm standoff from a detected submarine. Once the subsurface threat is neutralized the ASW LCS will continue on PIM and is available to assist the SUW LCS in a surface engagement.

There is a slight modeling issue regarding the ASW LCS detecting the submarine at 50 nm. This occurs because the submarine is essentially modeled like a surface contact, and the non-ASW assets (SUW LCS and SUW MH-60R/UAV) are simply told not to pursue that specific enemy. While this is a problem, I believe it is resolved through the fact that the ASW LCS cannot engage a submarine due to its lack of organic delivery of an ASW weapon (no SVTT). This being the case, while ASW LCS detects the submarine early the submarine isn't engaged until the MH-60R detects the submarine and pursues. The ASW LCS does act as a torpedo re-loader for the MH-60R which can only carry 3 torpedoes.

WWW.NPS.EDU

Source: Abbott 2008



ASW MH-60R

Weapon	Range	Pk	# Rounds
Mk 54 Torpedo	8 nm	NOLH	3

Sensors and Speed: With regard to speed, the ASW MH-60R is modeled exactly the same as the SUW MH-60R/UAV. For sensors, however, the ASW MH-60R is given a sensor range of 22 nm with a probability of detection that will be varied through the NOLH with a range of .5 - 1.0. This is to model the A/N-AQS-22 system that the MH-60R will be using to find the submarine. The A/N-AQS-22 is a system that is designed to be operated by a MH-60R in a hover, but I am not capable of modeling that in MANA. This may be one of the modeling issues I concede to the ASW field.

Personality Summary: The ASW MH-60R acts just like the SUW MH-60R/UAV (see above). Once an enemy is detected the ASW MH-60R will pursue and engage. Since the ASW MH-60R only has 3 torpedoes, once its primary ammunition is expended it transits to a reloading waypoint. Once the ASW MH-60R reaches the waypoint it is given 3 more torpedoes and is able to re-engage the enemy. A reloading waypoint is used to simulate the ASW MH-60R returning to its respective ASW LCS for an ammunition reload. Once the subsurface enemy is neutralized, the ASW MH-60R will continue to transit PIM and may assist in a surface engagement.

WWW.NPS.EDU

Source: Abbott 2008

Sensor	Range	Pk
UTAS	5 nm	NOLH
UDS	5 nm	NOLH

Sensors and Speed: For sensors an Unmanned Surface Vehicle is assigned per sensor, and is given a range of 5 nm with a probability of detection that will be varied through the NOLH with a range of .5 – 1.0. A speed of advance of 12 knots is given to the USVs as they operate much like the ASW MH-60R (dipping sonar) but with a lower maximum speed in between dips.

Personality Summary: The ASW USVs transit at a speed of 12 knots while looking for enemy submarines. Once a submarine is detected the ASW USV will close to help localize the enemy, and pass the information to the ASW LCS for prosecution.

WWW.NPS.EDU

Source: Abbott 2008

Sensor	Range	Pk
RTA (MFTA)	5 nm	NOLH
RTAS	5 nm	NOLH

Sensors and Speed: For sensors a Remotely Manned Vehicle is assigned per sensor, and is given a range of 5 nm with a probability of detection that will be varied through the NOLH with a range of .5 – 1.0. A speed of advance of 12 knots is given to the RMVs as they operate much like the ASW MH-60R (dipping sonar) but with a lower maximum speed in between dips.

Personality Summary: The ASW RMVs transit at a speed of 12 knots while looking for enemy submarines. Once a submarine is detected the ASW RMV will close to help localize the enemy, and pass the information to the ASW LCS for prosecution.

WWW.NPS.EDU

Source: Abbott 2008

APPENDIX B. EXPERIMENTAL DESIGNS

This appendix illustrates the Nearly Orthogonal Latin Hypercubes (NOLHs) used to conduct the simulation experiment, and their associated correlation matrices. Since no changes were made to the preliminary designs prior to running the full experiment, only the full designs are shown. Due to the size of the design, only a limited amount of the rows are provided. Correlation values are also provided.

A. EXPLORATORY DESIGN

Elements[]	1	2	3	4	5
low level	1	5	0.5	0.5	0.5
high level	3	50	1	1	1
decimals	0	0	3	3	3
factor name	SUW DD(X)	Swarm	155mm Pk	57mm Pk	DD(X) Pd
1	2	7	0.68	0.664	0.563
2	3	37	0.555	0.711	0.672
3	3	21	0.977	0.609	0.648
4	2	45	0.859	0.727	0.531
5	3	26	0.594	0.508	0.547
6	2	46	0.617	0.742	0.578
7	3	13	0.766	0.516	0.625
8	3	39	0.961	0.656	0.688
9	2	6	0.508	0.906	0.703
10	3	36	0.742	0.883	0.5
11	2	6	0.984	0.766	0.602
12	3	28	0.844	0.961	0.586
13	2	15	0.664	0.82	0.695
14	3	30	0.711	0.945	0.633
15	2	20	0.891	0.977	0.719
16	2	31	0.773	0.859	0.57
17	3	25	0.695	0.563	0.836
18	2	44	0.633	0.672	0.789
19	2	23	0.781	0.648	0.891
20	2	38	0.93	0.531	0.773
21	3	14	0.703	0.547	0.992
22	3	42	0.5	0.578	0.758
23	3	23	0.898	0.625	0.984
24	2	50	0.914	0.688	0.844
25	2	16	0.547	0.797	0.906
26	3	33	0.578	1	0.883
27	3	9	0.875	0.898	0.766
28	3	43	0.813	0.914	0.961
29	3	18	0.563	0.805	0.82
30	2	47	0.672	0.867	0.945
31	2	11	0.852	0.781	0.977
32	3	35	0.969	0.93	0.859
33	2	28	0.75	0.75	0.75
34	2	48	0.82	0.836	0.938

Correlation					
	SUW DD(X)	Swarm	155mm Pk	57mm Pk	DD(X) Pd
SUW DD(X)	1				
Swarm	0.005722	1			
155mm	0.023276	0.006203	1		
57mm	-0.066753	0.003870	-4.407E-08	1	
DD(X) Pd	-0.017391	0.003193	-4.407E-08	-4.407E-08	1

B. SUW FULL DESIGN

Elements[]	1	2	3	4	5	6	7	8	9	10	11	12	13	14	15	16	17	18	19
low level	1	1	0	5	1	0	0.5	0.5	0.5	0.5	0.5	0.5	0.5	0.5	0.5	0.5	0.5	0.5	0.5
high level	7	30	5	50	5	5	1	1	1	1	1	1	1	1	1	1	1	1	1
decimals	0	0	0	0	0	0	3	3	3	3	3	3	3	3	3	3	3	3	3
factor name	DDG	SUW LCS	ASW LCS	Red MB	Red Sub	Merchant	155mmPk	57mmPk	.50 Cal Pk	Ram Pk	DDG Pd	LCS Pd	SUW H Pd	Hellfire Pk	NLOS Pk	30mm Pk	ASW H Pd	Torp Pk	ASW O Pd
1	3	27	3	33	4	4	1	0.938	0.594	0.533	0.619	0.693	0.531	0.592	0.67	0.697	0.723	0.529	0.518
2	2	13	4	48	4	3	0.986	0.922	0.771	0.805	0.813	0.871	1	0.943	0.756	0.512	0.531	0.568	0.502
3	2	18	1	30	5	4	0.971	0.945	0.822	0.682	0.602	0.623	0.564	0.572	0.969	0.916	0.783	0.965	0.922
4	3	6	2	33	4	4	0.939	0.975	0.773	0.969	0.891	0.982	0.977	0.822	0.922	0.791	0.895	1	0.889
5	3	17	3	23	5	4	0.877	0.844	0.533	0.908	0.543	0.527	0.66	0.539	0.752	0.58	0.574	0.557	0.639
6	4	12	5	12	4	5	0.867	0.977	0.861	0.729	0.92	0.881	0.92	0.854	0.957	0.713	0.691	0.721	0.686
7	1	19	2	10	3	3	0.883	0.793	0.836	0.793	0.502	0.635	0.654	0.66	0.572	0.955	0.957	0.83	0.99
8	3	2	2	23	5	4	0.85	0.84	0.742	0.535	0.732	0.766	0.904	0.826	0.713	0.953	0.865	0.916	0.807
9	1	16	5	33	3	4	0.869	0.99	0.588	0.691	0.973	0.615	0.729	0.715	0.592	0.826	0.703	0.648	0.67
10	4	3	4	37	1	3	0.783	0.775	0.979	0.875	0.701	0.842	0.879	0.975	0.566	0.779	0.721	0.555	0.627
11	2	28	2	48	3	3	0.988	0.799	0.951	0.643	0.822	0.605	0.605	0.701	0.824	0.551	0.885	0.76	0.764
12	1	5	0	38	2	3	0.885	0.811	0.746	0.994	0.719	0.746	0.99	0.818	0.859	0.771	0.799	0.9	0.918
13	3	29	3	8	3	4	0.822	0.832	0.686	0.969	0.883	0.604	0.521	0.736	0.906	0.834	0.629	0.539	0.602
14	1	9	4	11	2	4	0.994	0.756	0.857	0.59	0.676	0.889	0.836	0.83	0.801	0.934	0.711	0.672	0.654
15	3	19	0	27	1	3	0.881	0.781	0.869	0.986	0.783	0.633	0.523	0.574	0.555	0.652	0.92	0.979	0.771
16	3	9	1	8	3	4	0.969	0.928	0.553	0.752	0.506	0.764	0.887	0.789	0.588	0.648	0.854	0.865	0.779
17	3	16	4	40	5	2	0.82	0.83	0.578	0.684	0.754	0.826	0.661	0.664	0.666	0.668	0.914	0.576	0.555
18	4	9	4	32	3	1	0.926	0.838	0.887	0.893	0.953	0.621	0.805	0.814	0.738	0.586	0.844	0.592	0.576
19	2	24	2	28	4	0	0.936	0.895	0.838	0.615	0.621	0.861	0.578	0.549	0.846	0.764	0.693	0.883	0.869
20	2	7	1	35	4	1	0.889	0.959	0.732	0.717	0.902	0.51	0.928	0.904	0.887	0.924	0.643	0.855	0.783
21	3	16	4	14	4	0	0.992	0.982	0.688	0.871	0.514	0.898	0.555	0.584	0.963	0.648	0.959	0.545	0.705
22	4	11	3	14	5	1	0.934	0.912	0.883	0.559	0.871	0.521	0.975	0.992	0.742	0.637	0.709	0.621	0.623
23	3	24	2	26	3	2	0.891	0.863	0.844	0.869	0.609	0.947	0.586	0.678	0.648	0.992	0.551	0.939	0.928
24	2	12	2	17	4	0	0.908	0.828	0.738	0.693	0.742	0.752	0.867	0.871	0.627	0.84	0.5	0.986	0.969
25	3	16	4	45	2	2	0.768	0.998	0.535	0.744	0.811	0.916	0.646	0.527	0.705	0.883	0.883	0.66	0.734
26	4	8	5	29	3	0	0.842	0.943	0.879	0.951	0.607	0.627	0.742	0.98	0.65	0.756	0.758	0.697	0.564
27	2	24	2	42	3	2	0.803	0.904	0.859	0.621	0.836	0.775	0.645	0.729	0.777	0.711	0.564	0.877	0.961
28	2	4	1	39	2	2	0.848	0.771	0.736	0.902	0.762	0.711	0.783	0.902	0.99	0.621	0.652	0.781	0.955
29	3	25	4	14	2	2	0.918	0.887	0.744	0.988	0.875	0.887	0.615	0.689	0.924	0.902	0.768	0.764	0.537

	DDG	SUW LCS	ASW LCS	Red MB	Red Sub	Merchant	155mmPk	57mmPk	.50 Cal Pk	Ram Pk	DDG Pd	LCS Pd	SUW H Pd	Hellfire Pk	NLOS Pk	30mm Pk	ASW H Pd	Torp Pk	ASW O Pd
DDG	1																		
SUW LCS	0.02262	1																	
ASW LCS	-0.00362	-0.00669	1																
Red MB	0.00943	-0.00077	-0.01385	1															
Red Sub	-0.04785	-0.01354	0.01264	0.01797	1														
Merchant	-0.02246	-0.01838	0.00043	0.00323	-0.01055	1													
155mmPk	0.01258	0.00453	0.00976	-0.00277	-0.00850	0.00298	1												
57mmPk	0.00966	0.01194	-0.01932	-0.00107	0.00970	0.00005	0.00000	1											
.50 Cal Pk	0.00676	0.00131	-0.01718	0.00161	-0.01967	0.01398	0.00125	0.00049	1										
Ram Pk	-0.00688	0.00179	0.00688	-0.02444	-0.01251	-0.00069	0.00001	-0.00355		1									
DDG Pd	-0.00597	0.00397	0.00244	-0.00061	-0.01049	0.00987	0.00001	-0.00212	0.00103	-0.00136	1								
LCS Pd	0.00709	-0.00391	-0.01609	-0.00205	-0.03613	-0.01555	0.00085	-0.00087	0.00188	0.00008	0.00032	1							
SUW H Pd	-0.00810	-0.00145	-0.01787	-0.00336	0.00791	0.00631	-0.00139	0.00074	-0.00007	-0.00198	-0.00042	-0.00211	1						
Hellfire Pk	-0.00601	0.00068	0.01423	0.00333	-0.01790	-0.01265	0.00081	0.00103	0.00104	-0.00101	0.00089	0.00006	0.00067	1					
NLOS Pk	0.00478	0.00409	-0.01212	-0.00001	0.00011	-0.00014	-0.00004	0.00107	-0.00009	-0.00140	0.00188	0.00002	-0.00103	-0.00120	1				
30mm Pk	-0.00464	0.00107	-0.00508	-0.00354	-0.01155	-0.01728	0.00215	-0.00078	0.00051	-0.00281	-0.00058	-0.00003	0.00294	-0.00164	0.00110	1			
ASW H Pd	-0.02443	0.00104	0.02285	-0.00637	-0.05080	0.00438	-0.00107	0.00096	0.00242	0.00210	0.00141	-0.00017	0.00024	-0.00170	0.00022	0.00217	1		
Torp Pk	-0.02862	0.00121	-0.02375	-0.00160	-0.04723	0.01825	-0.00074	-0.00200	0.00236	-0.00035	-0.00021	-0.00083	-0.00070	-0.00209	-0.00068	-0.00187	-0.00353	1	
ASW O Pd	-0.01002	0.00049	0.00735	0.00683	-0.03974	-0.00634	0.00261	-0.00040	-0.00033	-0.00141	-0.00024	-0.00036	0.00114	0.00013	0.00099	-0.00034	-0.00047	0.00007	1

C. AAW FULL DESIGN

Element[]	1	2	3	4	5	6	7	8	9	10	11	12	13	14	15	16	17	18	19	20	21
low level	1	1	1	0	5	1	0	0.5	0.5	0.5	0.5	0.5	0.5	0.5	0.5	0.5	0.5	0.5	0.5	0.5	
high level	30	7	30	5	50	5	5	1	1	1	1	1	1	1	1	1	1	1	1	1	
decimals	0	0	0	0	0	0	0	3	3	3	3	3	3	3	3	3	3	3	3	3	
factor name	Red A/C	DDG	SUW LCS	ASW LCS	Red MB	Red Sub	Merchant	155mmPk	57mmPk	.50 Cal Pk	Ram Pk	DDG Pd	LCS Pd	SUW H Pd	Hellfire Pk	NLOS Pk	30mm Pk	ASW H Pd	Torp Pk	ASW O Pd	SM-2 Pk
1	9	3	27	3	33	4	4	1	0.938	0.594	0.533	0.619	0.693	0.531	0.592	0.67	0.697	0.723	0.529	0.518	0.586
2	18	2	13	4	48	4	3	0.986	0.922	0.771	0.805	0.813	0.871	1	0.943	0.756	0.512	0.531	0.568	0.502	0.676
3	3	2	18	1	30	5	4	0.971	0.945	0.822	0.682	0.602	0.623	0.564	0.572	0.969	0.916	0.783	0.965	0.922	0.621
4	5	3	6	2	33	4	4	0.939	0.975	0.773	0.969	0.891	0.982	0.977	0.822	0.922	0.791	0.895	1	0.889	0.508
5	20	3	17	3	23	5	4	0.877	0												

	Red A/C	DDG	SUV LCS	ASV LCS	Red MB	Red Sub	Merchant	155mmPk	57mmPk	.50 Cal Pk	Ram Pk	DDG Pd	LCS Pd	SUV H Pd	Helire Pk	NLOS Pk	30mm Pk	ASV H Pd	Torp Pk	ASV O Pd	SM-2 Pk
Red A/C	1																				
DDG	0.00970	1																			
SUV LCS	-0.01663	0.02262	1																		
ASV LCS	-0.01161	-0.00362	-0.00669	1																	
Red MB	0.00143	0.00943	-0.00077	-0.01385	1																
Red Sub	-0.01895	-0.04785	-0.01254	-0.01264	0.01797	1															
Merchant	0.01239	-0.02246	-0.01938	0.00943	0.00323	-0.01055	1														
155mmPk	-0.00058	0.01258	0.00453	0.00976	-0.00277	-0.00850	0.00298	1													
57mmPk	-0.00462	0.00966	0.01194	-0.01522	-0.00107	0.00970	0.00005	0.00000	1												
.50 Cal Pk	-0.00668	0.00676	0.00131	-0.01718	0.01611	-0.01967	0.01398	0.00125	0.00049	1											
Ram Pk	0.00211	-0.00688	0.00179	0.00688	-0.00159	-0.02444	-0.01351	-0.00669	0.00001	-0.00355	1										
DDG Pd	-0.00101	-0.00597	0.00397	0.00241	-0.00081	-0.01049	0.00967	0.00001	-0.00212	0.00163	-0.00126	1									
LCS Pd	0.00253	0.00709	-0.00391	-0.01699	-0.00205	-0.02813	-0.01555	0.00095	-0.00087	0.01018	0.00008	0.00032	1								
SUV H Pd	0.00198	-0.00810	-0.00145	-0.01787	-0.00336	0.00791	0.00631	-0.00139	0.00074	-0.00007	-0.00198	-0.00042	-0.00211	1							
Helire Pk	-0.00228	-0.00601	0.00068	0.01423	0.00333	-0.01790	-0.01265	0.00081	0.00103	0.00104	-0.00101	0.00089	0.00006	0.00067	1						
NLOS Pk	-0.00270	0.00478	0.00489	-0.01512	-0.00001	0.00011	-0.00014	-0.00094	0.00107	-0.00069	-0.00140	0.00188	0.00002	-0.00103	-0.00120	1					
30mm Pk	-0.00025	-0.00464	0.00107	-0.00508	-0.00354	-0.00155	-0.01728	0.00215	-0.00078	0.00051	-0.00281	-0.00058	-0.00003	0.00294	-0.00184	0.00110	1				
ASV H Pd	-0.00329	-0.02443	0.00104	0.02206	-0.00637	-0.00980	0.00438	-0.00107	0.00086	0.00242	0.00218	0.00141	-0.00017	0.00024	-0.00170	0.00022	0.00217	1			
Torp Pk	0.00147	-0.02862	0.00121	-0.02375	-0.00160	0.04723	0.01825	-0.00074	-0.00200	0.00236	-0.00025	-0.00021	-0.00083	-0.00070	-0.00209	-0.00088	-0.00187	-0.00353	1		
ASV O Pd	0.00122	-0.01002	0.00049	0.00735	0.00663	-0.03974	-0.00634	0.00261	-0.00040	-0.00033	-0.00141	-0.00024	-0.00036	0.00114	0.00013	0.00099	-0.00034	-0.00047	0.00007	1	
SM-2 Pk	-0.00380	0.00658	0.00262	0.02352	-0.00125	0.00216	0.01149	-0.00075	-0.00129	0.00276	-0.00117	-0.00047	0.00031	-0.00030	0.00148	0.00024	0.00067	-0.00048	-0.00086	-0.00050	1

THIS PAGE INTENTIONALLY LEFT BLANK

APPENDIX C. GRAPHS AND CHARTS

This appendix provides the graphs and charts produced for this study and are associated with the data analysis provided in Chapter IV.

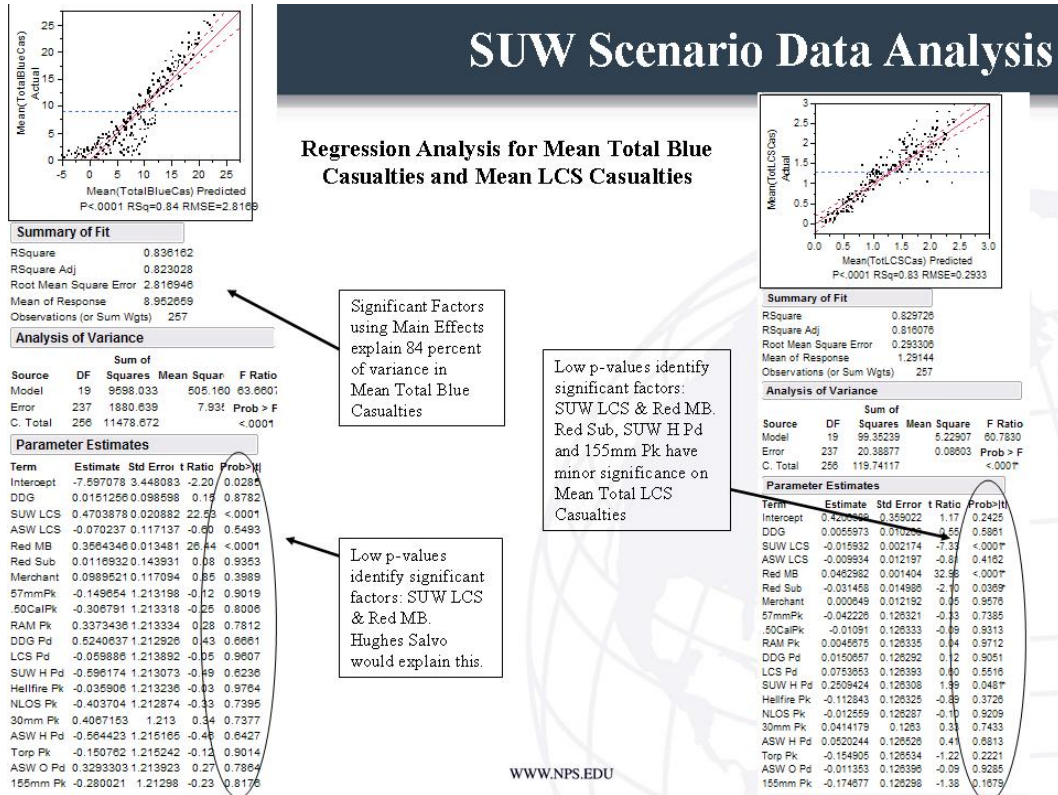



SUW Scenario Data Analysis

R Square	Number N of Splits
0.918	287

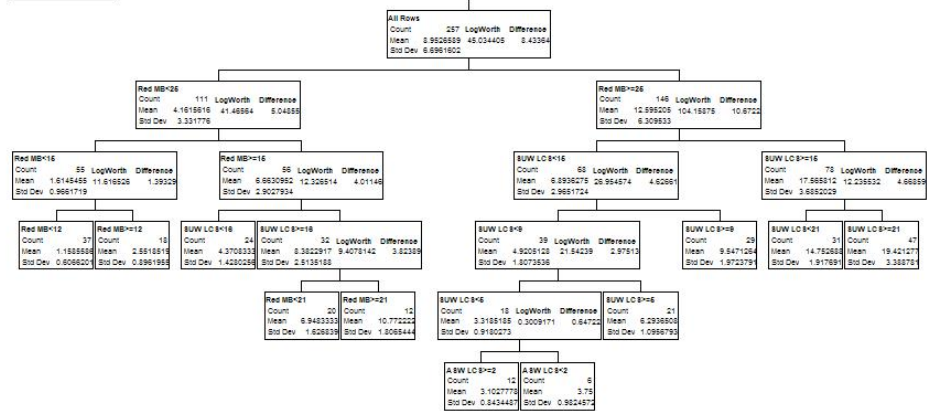

Regression tree for Mean (Total Blue Casualties)

- Enemy Missile Boats play a significant role
- Suggested maximum of SUW LCS is 15 when there are less than 25 missile boats
- If greater than 25 missile boats and less than 5 SUW LCS and approximately 2-3 ASW LCS are necessary to reduce Blue force casualties. Hughes Salvo Equation explains this.
 - Squadron size: 3-4 SUW LCS + 2-3 ASW LCS
- Recommend setting 5 LCS as lower bound and 11 LCS as upper bound

WWW.NPS.EDU



SUW Scenario Data Analysis

R Square	Number N of Splits
0.876	287

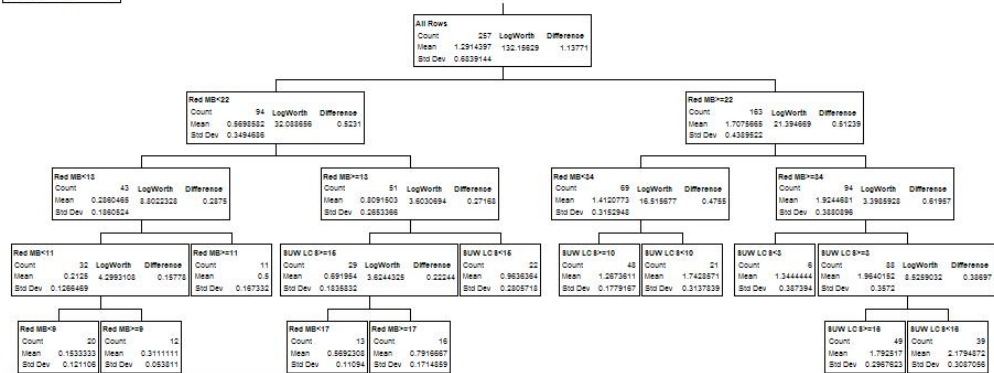

Regression tree for Mean (Total LCS Casualties)

- Enemy Missile Boats play a significant role
- Suggested maximum of SUW LCS is 15 when there are less than 22 missile boats
- If greater than 34 missile boats and between 3 and 16 SUW LCS are necessary to reduce LCS casualties.
- Supports Maximum LCS squadron size 15 LCS

WWW.NPS.EDU



SUW Scenario Data Analysis

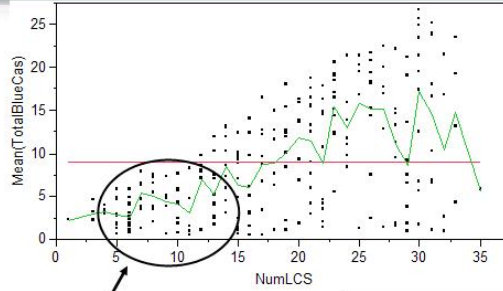

Graphs of Mean Total Blue Casualties, and Mean Total Red Casualties illustrating the impact of an employable LCS squadron

Mean total Blue casualties increase at a slower rate in the range of 5 to 11 LCS

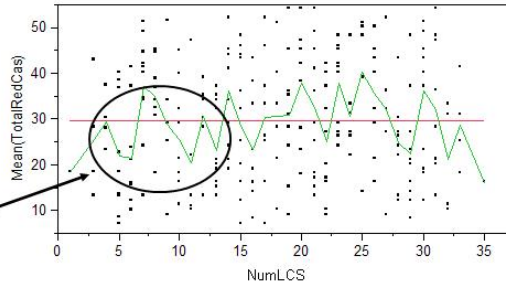

WWW.NPS.EDU



SUW Scenario Data Analysis

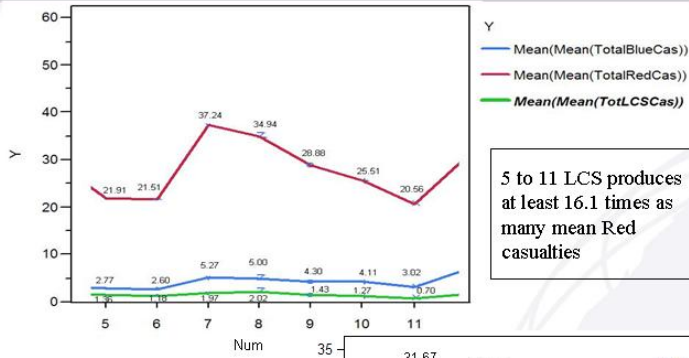

5 to 11 LCS produces at least 16.1 times as many mean Red casualties

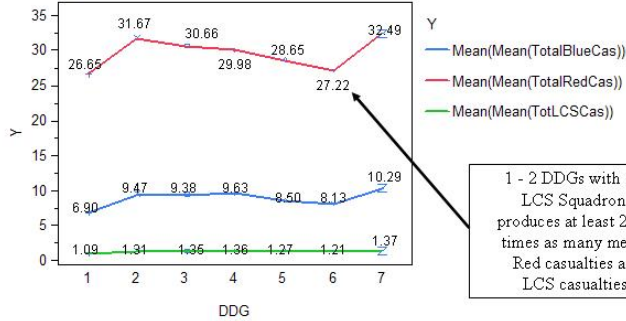

1 - 2 DDGs with an LCS Squadron produces at least 22.0 times as many mean Red casualties as LCS casualties



Bivariate Fit of Mean(TotalRedCas) By NumLCS

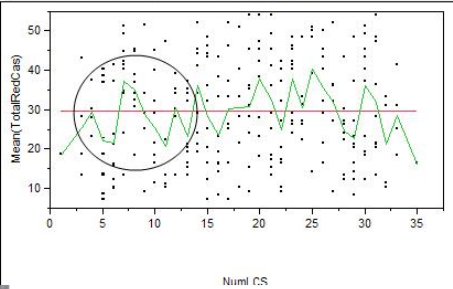

Bivariate Fit of Mean(TotalBlueCas) By NumLCS

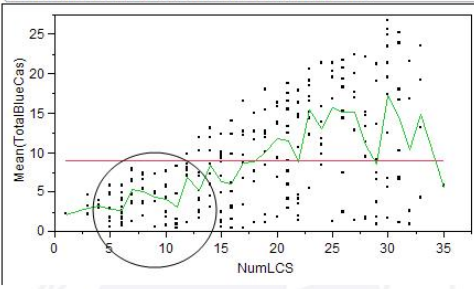

Bivariate Fit of Mean(TotLCSCas) By NumLCS

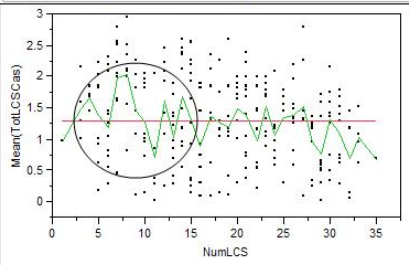

Graphs showing the Number of LCS and their impact on casualties

WWW.NPS.EDU

SUW Scenario Data Analysis

Regression Analysis of Mean Total Red Casualties

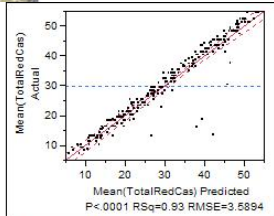

Summary of Fit

RSquare	0.929224
RSquare Adj	0.92355
Root Mean Square Error	3.589417
Mean of Response	29.82685
Observations (or Sum Wgts)	257

Analysis of Variance

Source	DF	Squares	Mean Square	F Ratio
Model	19	40089.681	2109.98	163.7688
Error	237	3053.488	12.88	Prob > F
C. Total	256	43143.169		<.0001*

Parameter Estimates

Term	Estimate	Std Error	t Ratio	Prob> t
Intercept	-4.290733	4.393626	-0.98	0.3298
DDG	-0.14514	0.125635	-1.16	0.2492
SUW LCS	0.1669099	0.026608	6.27	<.0001*
ASW LCS	-0.0577	0.149259	-0.39	0.6994
Red MB	0.9458542	0.017177	55.08	<.0001*
Red Sub	0.8712074	0.1834	4.75	<.0001*
Merchant	-0.12567	0.149203	-0.84	0.4005
57mmPk	0.2430168	1.545885	0.16	0.8762
.50CalPk	1.6347144	1.546038	1.06	0.2914
RAM Pk	0.0859469	1.546058	0.06	0.9557
DDG Pd	-0.252144	1.545538	-0.16	0.8705
LCS Pd	1.2713612	1.546769	0.82	0.4119
SUW H Pd	2.4178333	1.545725	1.56	0.1191
Hellfire Pk	-0.239105	1.545933	-0.16	0.8772
NLOS Pk	-1.137524	1.545472	-0.74	0.4624
30mm Pk	0.0263969	1.545633	0.02	0.9864
ASW H Pd	2.1199096	1.548392	1.37	0.1723
Torp Pk	-0.544413	1.54849	-0.35	0.7255
ASW O Pd	-0.99582	1.546809	-0.64	0.5203
155mm Pk	-0.486231	1.545607	-0.31	0.7534

Significant Factors using Main Effects explain 93 percent of variance in Mean

Low p-values identify significant factors: SUW LCS, Red MB & Red Sub. Red MB are the most significant with its high t-Ratio.

WWW.NPS.EDU



AAW Scenario Data Analysis

R Square	Number N of Splits
0.582	256

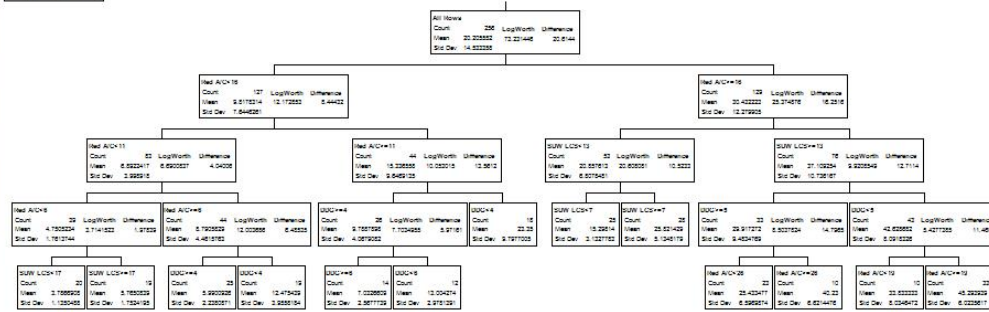

AAW - Regression tree for Mean Total Blue Casualties

- Enemy Aircraft play a significant role
- Suggested maximum of SUW LCS is 17 when there are less than 11 aircraft
- If greater than 16 aircraft, then less than 13 SUW LCS and greater than 7 SUW LCS are necessary to reduce Blue force casualties. The addition of 1-4 DDGs is necessary to provide a creditable AAW protection and reduces Blue force casualties.
- Squadron size: 5-7 SUW LCS + 1-2 ASW LCS + 1-4 DDGs
- Recommend setting 5 LCS as lower bound and 13 LCS as upper bound

WWW.NPS.EDU



AAW Scenario Data Analysis

R Square	Number N of Splits
0.784	256

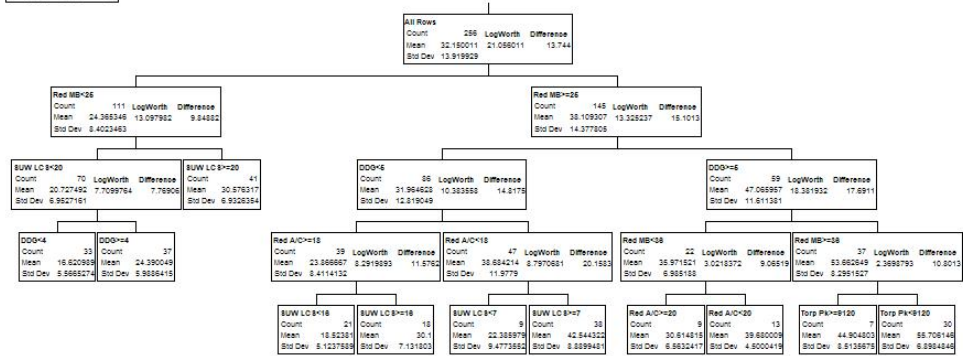

AAW - Regression tree for Mean Total Red Casualties

- Enemy Aircraft and Missile Boats play a significant role
- Suggested maximum of 5 DDG in all cases when Missile boats exceed 25 and aircraft exceed 18.
- Suggested maximum of SUW LCS is 15 when there are greater than 18 aircraft
 - If less than 18 aircraft, then less than 7 SUW LCS are required to reduce Blue force casualties.
- Squadron size: 5-7 SUW LCS + 1-2 ASW LCS + 1-2 DDGs

WWW.NPS.EDU



AAW Scenario Data Analysis

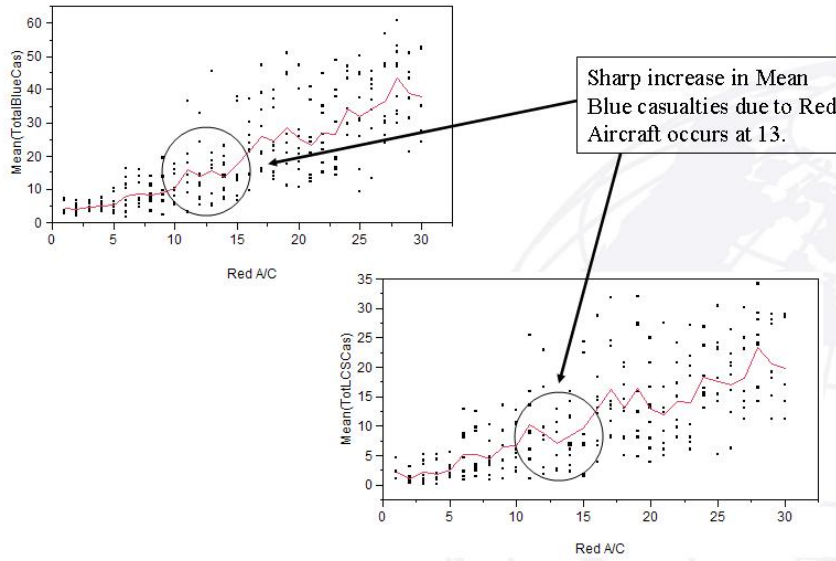

WWW.NPS.EDU



AAW Scenario Data Analysis

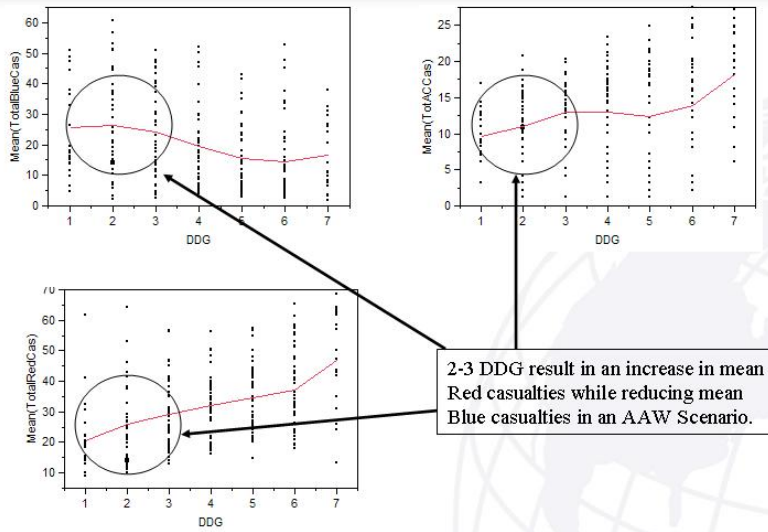

WWW.NPS.EDU

AAW Scenario Data Analysis

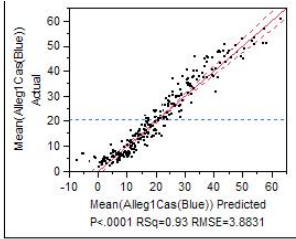

Summary of Fit

RSquare	0.932726
RSquare Adj	0.928521
Root Mean Square Error	3.883083
Mean of Response	20.21336
Observations (or Sum Wgts)	256

Analysis of Variance

Source	DF	Sum of Squares	Mean Square	F Ratio	Prob > F
Model	15	50173.077	3344.87	221.8330	
Error	240	3618.800	15.08		<.0001*
C. Total	255	53791.878			

Parameter Estimates

Term	Estimate	Std Error	t Ratio	Prob> t
Intercept	-2.945632	2.538369	-1.16	0.2470
Red A/C	1.3588732	0.028808	47.17	<.0001*
DDG	-2.517368	0.135829	-18.53	<.0001*
SUW LCS	0.584979	0.028892	20.25	<.0001*
ASW LCS	0.4289393	0.161309	2.66	0.0084*
Red MB	0.0944842	0.018589	5.08	<.0001*
Red Sub	-0.349107	0.197776	-1.77	0.0788
RAM Pk	0.0002194	0.000168	1.31	0.1929
DDG Pd	-0.000596	0.000167	-3.56	0.0004*
SUW H Pd	0.0004519	0.000168	2.69	0.0077*
(Red A/C-15.5273)*(SUW LCS-15.457)	0.056705	0.003917	14.48	<.0001*
(Red A/C-15.5273)*(ASW LCS-2.5)	0.0454194	0.017689	2.57	0.0108*
(DDG-4.00781)*(SUW LCS-15.457)	-0.110771	0.022167	-5.00	<.0001*
(SUW LCS-15.457)*(Red MB-27.4805)	0.0047224	0.002251	2.10	0.0369*
(Red MB-27.4805)*(RAM Pk-7508.55)	-4.064e-5	1.726e-5	-2.35	0.0194*
(Red MB-27.4805)*(SUW H Pd-7508.63)	-2.062e-5	1.224e-5	-1.68	0.0934*

Mean Total Blue Casualties using Effects Screening for 7 to 13 LCS and all DDG

- These parameters with the interaction terms explain 93 per cent of the variance in mean total blue casualties in the data where 7 to 13 LCS and all DDGs.

- Identifies Red A/C, DDG, SUW LCS, Red MB, DDG Pd, SUW H Pd and many interactions as significant.

WWW.NPS.EDU

AAW Scenario Data Analysis

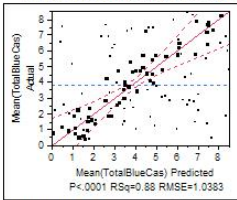

Summary of Fit

RSquare	0.881656
RSquare Adj	0.792002
Root Mean Square Error	1.038286
Mean of Response	3.846893
Observations (or Sum Wgts)	59

Analysis of Variance

Source	DF	Squares	Mean Square	F Ratio	Prob > F
Model	25	285.03394	10.6014	9.8339	
Error	33	35.57522	1.0790		<.0001*
C. Total	58	300.60915			

Parameter Estimates

Term	Estimate	Std Error	t Ratio	Prob> t
Intercept	-3.091983	2.757343	-1.12	0.2702
57mmPk	-0.898050	1.283746	-0.70	0.4891
50CalPk	7.5109885	1.782877	4.21	0.0002*
RAM Pk	2.2388727	1.042004	2.15	0.0391*
DDG Pd	-1.285542	1.269742	-1.01	0.3187
LCS Pd	-3.984431	1.19929	-3.36	0.0029*
SUW H Pd	-1.853117	1.218222	-1.52	0.1371
NLOS Pk	-0.217067	1.198167	-0.18	0.8571
30mm Pk	-1.1097117	1.114497	-1.03	0.3145
ASW H Pd	0.9479953	1.074615	0.88	0.3841
Torp Pk	5.7708208	1.764615	3.27	0.0029*
ASW O Pd	3.3505884	1.180808	2.84	0.0077*
155mm Pk	-0.211725	1.115205	-0.19	0.8506
(57mmPk-0.74322)*(RAM Pk-0.75764)	-35.08429	8.4661	-4.14	0.0002*
(57mmPk-0.74322)*(ASW O Pd-0.74181)	91.588172	14.85005	6.13	<.0001*
(57mmPk-0.74322)*(155mm Pk-0.7538)	47.773875	13.0835	3.65	0.0009*
(50CalPk-0.75829)*(SUW H Pd-0.7549)	19.095418	9.044618	2.11	0.0424*
(50CalPk-0.75829)*(NLOS Pk-0.75758)	-57.88989	5.996999	-9.62	<.0001*
(50CalPk-0.75829)*(30mm Pk-0.74)	34.722977	8.275917	4.20	0.0002*
(50CalPk-0.75829)*(155mm Pk-0.7538)	47.155738	10.88466	4.40	0.0001*
(RAM Pk-0.75764)*(NLOS Pk-0.75758)	31.419918	7.448421	4.22	0.0002*
(DDG Pd-0.7398)*(ASW H Pd-0.7841)	38.868407	10.90952	3.56	0.0011*
(LCS Pd-0.7819)*(SUW H Pd-0.7549)	-48.31175	8.850074	-5.46	<.0001*
(SUW H Pd-0.7549)*(ASW O Pd-0.74181)	40.372208	7.481331	5.40	<.0001*
(NLOS Pk-0.75758)*(ASW O Pd-0.74181)	-32.45848	8.953522	-3.63	0.0010*
(Torp Pk-0.74136)*(ASW O Pd-0.74181)	-81.73817	12.55899	-6.52	<.0001*

• Weapons and Sensors Only

• Mean Total Blue Casualties and Mean Total Red Casualties using Effects Screening for 5 to 11 LCS and all DDG

• These parameters with the interaction terms explain 88 & 89 percent of the variance in both means for 5 to 11 LCS and all DDGs.

Identified 50Cal Pk, LCS Pd, Torp Pk, RAM Pk, ASW O Pd as significant. Interaction terms were others as significant.

WWW.NPS.EDU

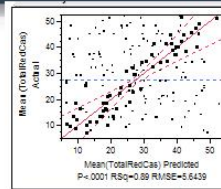

Summary of Fit

RSquare	0.889208
RSquare Adj	0.815057
Root Mean Square Error	6.643869
Mean of Response	27.34407
Observations (or Sum Wgts)	59

Analysis of Variance

Source	DF	Squares	Mean Square	F Ratio	Prob > F
Model	22	8842.8080	401.946	12.6187	
Error	36	1146.7174	31.853		<.0001*
C. Total	58	9989.5254			

Parameter Estimates

Term	Estimate	Std Error	t Ratio	Prob> t
Intercept	9.036816	13.70782	0.66	0.5139
57mmPk	-8.62027	8.781174	-0.64	0.5248
50CalPk	19.88458	8.565649	2.32	0.0250*
RAM Pk	7.289162	5.844212	1.31	0.1969
LCS Pd	-9.742987	6.262004	-1.56	0.1278
SUW H Pd	2.4659784	6.087469	0.41	0.6878
NLOS Pk	-10.43361	6.316376	-1.65	0.1072
30mm Pk	-6.863868	5.782137	-1.19	0.2367
ASW H Pd	6.0274495	6.188655	0.98	0.3319
Torp Pk	-2.107603	6.517388	-0.32	0.7483
ASW O Pd	24.230224	6.588862	3.69	0.0007*
(57mmPk-0.74322)*(RAM Pk-0.75764)	-208.9089	45.95482	-4.55	<.0001*
(57mmPk-0.74322)*(ASW O Pd-0.74181)	318.8622	68.56953	4.65	<.0001*
(50CalPk-0.75829)*(NLOS Pk-0.75758)	-409.5381	40.87948	-10.02	<.0001*
(50CalPk-0.75829)*(30mm Pk-0.74)	148.83279	44.89845	3.33	0.0020*
(50CalPk-0.75829)*(ASW O Pd-0.74181)	-109.7202	60.32659	-1.82	0.0773
(RAM Pk-0.75764)*(NLOS Pk-0.75758)	116.14434	38.35891	3.03	0.0045*
(RAM Pk-0.75764)*(Torp Pk-0.74136)	116.81093	48.05176	2.44	0.0157*
(LCS Pd-0.7819)*(SUW H Pd-0.7549)	-194.3047	48.08488	-4.04	0.0005*
(LCS Pd-0.7819)*(NLOS Pk-0.75758)	195.86595	48.96465	2.20	0.0289*
(SUW H Pd-0.7549)*(ASW H Pd-0.7541)	-133.6239	37.48074	-3.58	0.0011*
(SUW H Pd-0.7549)*(ASW O Pd-0.74181)	159.50178	42.66738	3.74	0.0006*
(Torp Pk-0.74136)*(ASW O Pd-0.74181)	-172.0354	48.5364	-3.54	0.0011*



AAW Scenario Data Analysis

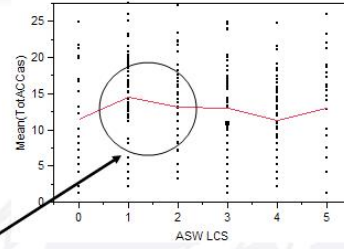
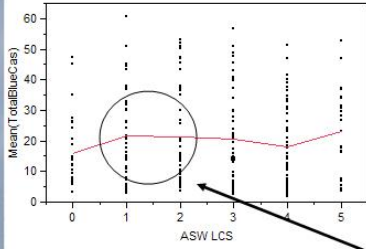

1-2 ASW LCS reduces both mean Blue and mean LCS casualties while increasing mean Aircraft and mean Red casualties in an AAW Scenario.

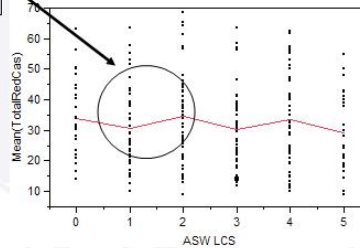
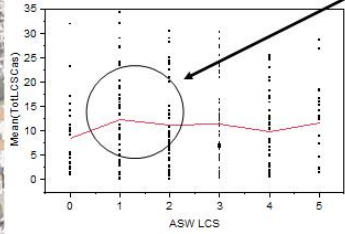

THIS PAGE INTENTIONALLY LEFT BLANK

LIST OF REFERENCES

- Abbott, B.P. (2008, March). Littoral combat ship (LCS) mission packages: Determining the best mix. Master's Thesis. Monterey, CA: Naval Postgraduate School.
- Bain, M.D. (2005, September). Supporting a Marine Corps distributed operations platoon: A quantitative analysis. Master's Thesis, Monterey, CA: Naval Postgraduate School.
- Cioppa, T.M., Lucas, T.W., & Sanchez, S.M. (2004). Military applications of agent based simulations. Proceedings of the 2004 Winter Simulation Conference.
- Cioppa, T.M. (2002, September). Efficient nearly orthogonal and space-filling experimental designs for high-dimensional complex models. Doctoral dissertation, Monterey, CA: Naval Postgraduate School.
- Commander Naval Surface Forces. (2007, January 7). Littoral combat ship platform wholeness concept of operations (Revision B).
- Dunnigan, J.F., & Nofi, A.A. (1995). *Victory at sea*. William Morrow & Company, Inc., 537-539.
- Federation of American Scientists. (2008). Retrieved on July 2008 from <http://www.fas.org>.
- Global Security.Org. (2008). Retrieved on July 2008 from <http://www.globalsecurity.org>.
- Jane's Information Group Limited. (2005). *Fighting ships 2005 – 2006*. United Kingdom: Thanet Press.
- Jane's Information Group Limited. (2005). *All the world's aircraft 2005 – 2006*. United Kingdom: Thanet Press.
- Joint Requirements Oversight Council. (2004, January 16). Initial capabilities document for assured access in the littorals. ACAT: I.
- MANA (Map Aware Non-Uniform Automata), Version 4. (2007, May). *User Manual*. Operations Analysis Section, Defence Technology Agency.
- Naval Education and Training Command. (2000, October). Radar fundamentals chart: Radar systems of the U.S. Navy. *Fire-Control Rate Training Manual*, Fire Controlman, Volume 2, NAVEDTRA 14099, United States Navy.
- Naval Warfare Development Command. (2007, March 14). Littoral combat ship warfighting concept of operations (Revision A).

- O'Rourke, R., "Navy DDG-1000 destroyer program: Background, oversight issues, and options for Congress," CRS Report for Congress. July 2008.
- Peoships. (2008, July). U.S. Navy littoral combat ship. Program Executive Office Ships Online. Retrieved on July 2008 from <http://peoships.crane.navy.mil/lcs/program.htm>.
- RAND Corporation. (2007). Littoral combat ships - Relating performance to mission package inventories, homeports, and installation sites. RAND Study.
- Taylor, S. (2007, April 17). MCM systems for littoral combat ship advanced flight mission package industry day brief. Office of Naval Research.
- Wikipedia. (2008, July). AN/SPY-3 radar. Retrieved on July 2008 from http://en.wikipedia.org/wiki/AN_SPY3.
- Wright, W. (2004, November). LCS mission module overview. Mission Modules Program Office. PMS 420.

INITIAL DISTRIBUTION LIST

1. Dr. Thomas Lucas
Naval Postgraduate School
Monterey, California
2. Dudley Knox Library
Naval Postgraduate School
Monterey, California
3. CAPT Doug Otte, USN
Naval Postgraduate School
Monterey, California
4. CAPT Jeff Kline, USN (Ret.)
Naval Postgraduate School
Monterey, California
5. Mr. Edward J. Lesnowicz, Col, USMC (Ret.)
Naval Postgraduate School
Monterey, California
6. Dr. Mathias Kolsch
Naval Postgraduate School
Monterey, California
7. CDR Joseph A. Sullivan
Naval Postgraduate School
Monterey, California
8. Curtis Blais
Naval Postgraduate School
Monterey, California