



Calhoun: The NPS Institutional Archive
DSpace Repository

Reports and Technical Reports

All Technical Reports Collection

2007

**Perfect Storm: analyzing strategic issues
confronting program executive office, missiles
and space**

Anderson, Joseph S.; Warnick, David A.

Monterey, California. Naval Postgraduate School

<https://hdl.handle.net/10945/407>

Downloaded from NPS Archive: Calhoun



Calhoun is the Naval Postgraduate School's public access digital repository for research materials and institutional publications created by the NPS community. Calhoun is named for Professor of Mathematics Guy K. Calhoun, NPS's first appointed -- and published -- scholarly author.

Dudley Knox Library / Naval Postgraduate School
411 Dyer Road / 1 University Circle
Monterey, California USA 93943

<http://www.nps.edu/library>

NPS-AM-07-042



ACQUISITION RESEARCH SPONSORED REPORT SERIES

**“Perfect Storm”: Analyzing Strategic Issues Confronting
Program Executive Office, Missiles and Space**

30 March 2007

by

MAJ Joseph S. Anderson, USA, and

MAJ David A. Warnick, USA

Advisors: Cary L. Simon, Lecturer, and

Keith F. Snider, Associate Professor,

Graduate School of Business & Public Policy

Naval Postgraduate School

Approved for public release, distribution unlimited.

Prepared for: Naval Postgraduate School. Monterey. California 93943



ACQUISITION RESEARCH PROGRAM
GRADUATE SCHOOL OF BUSINESS & PUBLIC POLICY
NAVAL POSTGRADUATE SCHOOL

The research presented in this report was supported by the Acquisition Chair of the Graduate School of Business & Public Policy at the Naval Postgraduate School.

To request Defense Acquisition Research or to become a research sponsor, please contact:

NPS Acquisition Research Program
Attn: James B. Greene, RADM, USN, (Ret)
Acquisition Chair
Graduate School of Business and Public Policy
Naval Postgraduate School
555 Dyer Road, Room 332
Monterey, CA 93943-5103
Tel: (831) 656-2092
Fax: (831) 656-2253
e-mail: jbgreene@nps.edu

Copies of the Acquisition Sponsored Research Reports may be printed from our website www.acquisitionresearch.org



ACQUISITION RESEARCH PROGRAM
GRADUATE SCHOOL OF BUSINESS & PUBLIC POLICY
NAVAL POSTGRADUATE SCHOOL

Abstract

This MBA Project analyzed the following four strategic issues surrounding Program Executive Office Missiles and Space: the implementation of Program Budget Decision 753, the deterioration of the matrix support structure, the aging of the civilian workforce, and the influx of new organizations resulting from the Base Realignment and Closure process. The goals of this project were to conduct an analysis of the interrelationships among several strategic problems and challenges facing PEO, Missiles and Space, to provide a scientific foundation from which alternatives can be drawn and to present a sound case analysis that can be used by PEO, Missiles and Space, the Army Acquisition community, and similar Department of Defense commands. This project was conducted with the sponsorship and assistance of the Acquisition Research Program, Naval Postgraduate School and Program Executive Office, Missiles and Space, Redstone Arsenal, Alabama.

Keywords: Program Executive Office, Missiles and Space, strategic issues, Program Budget Decision 753, BRAC, personnel, funding, aging of the workforce, Organizational Systems Framework model, matrix support, contractor support



THIS PAGE INTENTIONALLY LEFT BLANK



ACQUISITION RESEARCH PROGRAM
GRADUATE SCHOOL OF BUSINESS & PUBLIC POLICY
NAVAL POSTGRADUATE SCHOOL

Acknowledgements

First and foremost, we would like to thank our families for their unwavering support throughout this process and over the entire length of our program. Second, we would like to thank our advisors, editors and reviewers for their steadfast dedication and patience. We also acknowledge the support of the Acquisition Chair at the Naval Postgraduate School for providing funding for this research and of its entire team for providing tremendous assistance. And finally, we would like to express our gratitude to PEO, Missiles and Space for their generosity, candor and commitment to this project.



THIS PAGE INTENTIONALLY LEFT BLANK



NPS-AM-07-042



ACQUISITION RESEARCH SPONSORED REPORT SERIES

**“Perfect Storm”: Analyzing Strategic Issues Confronting
Program Executive Office, Missiles and Space**

30 March 2007

by

MAJ Joseph S. Anderson, USA, and

MAJ David A. Warnick, USA

Advisors: Cary L. Simon, Lecturer, and

Keith F. Snider, Associate Professor,

Graduate School of Business & Public Policy

Naval Postgraduate School

Disclaimer: The views represented in this report are those of the author and do not reflect the official policy position of the Navy, the Department of Defense, or the Federal Government.



ACQUISITION RESEARCH PROGRAM
GRADUATE SCHOOL OF BUSINESS & PUBLIC POLICY
NAVAL POSTGRADUATE SCHOOL

- v -

THIS PAGE INTENTIONALLY LEFT BLANK



ACQUISITION RESEARCH PROGRAM
GRADUATE SCHOOL OF BUSINESS & PUBLIC POLICY
NAVAL POSTGRADUATE SCHOOL

Table of Contents

I. INTRODUCTION	1
A. PURPOSE	1
B. SCOPE	2
C. METHODOLOGY	2
D. RESEARCH QUESTIONS.....	2
II. BACKGROUND.....	5
A. OVERVIEW	5
B. PEO, MISSILES AND SPACE	5
C. DEFENSE BUDGETING AND PROGRAM BUDGET DECISIONS	8
D. THE AGING WORKFORCE	11
E. BASE REALIGNMENT AND CLOSURE (BRAC)	12
F. ORGANIZATIONAL SYSTEM'S FRAMEWORK MODEL.....	14
G. CHAPTER SUMMARY	21
III. FINDINGS AND ANALYSIS SYSTEM INPUTS.....	23
A. OVERVIEW	23
B. FINDINGS: ENVIRONMENT/CONTEXT	23
D. FINDINGS: KEY SUCCESS FACTORS	35
E. ANALYSIS: KEY SUCCESS FACTORS.....	36
F. FINDINGS: SYSTEM DIRECTION	37
E. ANALYSIS: SYSTEM DIRECTION.....	43
F. CHAPTER SUMMARY	44



IV.	FINDINGS AND ANALYSIS SYSTEM THROUGHPUTS	45
A.	OVERVIEW	45
B.	DESIGN FACTORS.....	45
C.	CHAPTER SUMMARY	57
V.	FINDINGS AND ANALYSIS SYSTEM OUTPUT.....	59
A.	CULTURE.....	59
B.	OUTPUTS.....	61
C.	OUTCOMES	65
D.	CHAPTER SUMMARY	66
VI.	CONCLUSIONS AND RECOMMENDATIONS.....	67
A.	OVERVIEW	67
B.	CONCLUSION ONE	67
C.	CONCLUSION TWO	68
D.	CONCLUSION THREE.....	70
E.	CONCLUSION FOUR.....	71
F.	CHAPTER SUMMARY	72
	LIST OF REFERENCES.....	73
	APPENDIX A. SEMI-STRUCTURED RESEARCH QUESTIONS.....	75



Executive Summary

In April of 2006, a white paper with the subject line of “Personnel Crisis, Redstone Arsenal” was forwarded from the Program Executive Officer for PEO, Missiles and Space to the Office of the Assistant Secretary of the Army (Acquisition, Logistics, and Technology). This document warned of a looming personnel crisis brought on by the coincidence of four major issues. The four issues were identified as Program Budget Decision 753, deterioration of the matrix support base, the aging workforce, and the influx of new organizations as a result of the 2005 BRAC decisions. Recognizing that some or all of these factors were common to most organizations in the Department of Defense, further investigation into these strategic issues seemed warranted. With the cooperation of PEO, Missiles and Space, an independent effort was initiated to further characterize the identified crisis with the intent of drawing conclusions and making recommendations that would benefit the PEO and other organizations confronted with similar strategic issues.

The methodology employed was to use the Organizational Systems Framework model, a flexible tool capable of taking into account multiple interrelated variables, to characterize the complex issues being analyzed. The primary methods for collecting the data necessary to effectively utilize the model were: literature research to obtain background information, teleconferences with select PEO, Missiles and Space staff members, and a site visit to conduct semi-structured interviews. During our initial broad investigation of the strategic issues confronting the PEO, it became clear that in its characterizing of the Perfect Storm argument, PEO, Missiles and Space had discovered a related and more significant strategic issue. This issue centered on the missile technology base and the risks knowingly or unknowingly being accepted in that area. This component and its link to the original Perfect Storm initiatives became the focus of our research.

Through the use of the open systems model, we characterized various aspects of the issues confronting PEO, Missiles and Space in terms of three main



areas: inputs, throughputs (organizational design factors), and results. In terms of organizational inputs, we found that the external environment to the PEO was identified as an area in which recent and evolving changes have placed an interrelated and substantial burden on the organization. The current operational environment in the execution of the Global War on Terror is resource intensive. Providing essential resources is a paramount priority—often driving an array of funding decisions. In short, missile technologies have not fared well. Science and technology funding has been flat or declining, developmental systems have been eliminated or delayed, and production quantities have been reduced. These factors and trends contribute to a number of consequences, including personnel and structural disruptions. Recognizing that the Army has chosen to accept risk in certain areas, industry has moved its missile technical expertise into other fields with higher priorities in the current operational environment and with better prospects for future profits. Although we found that PEO, Missiles and Space is capable of meeting its short-term output requirements, mid-to-longer-term results will be markedly more difficult to achieve (i.e., five years out). If current trends continue, the intersection of the declining missile technology base issue, with the personnel issues identified in the Perfect Storm argument will lead to mid- and longer-term unresolved personnel problems.

Based on these findings and other relevant analysis contained in this report, four conclusions were drawn regarding the strategic issues confronting PEO, Missiles and Space. The primary conclusion is that PEO, Missiles and Space has entered into a vicious downward spiral from which substantial external assistance will be required to recover. This spiral was initiated by recent funding decisions that industry has interpreted as a signal of limited prospects in missile-related technologies. As more time passes and this signal is not changed, personnel discontinuities and mission loss further perpetuate related factors caught-up in the accelerating spiral: i.e., loss of institutional knowledge due to personnel departures from the critical technological fields. The risk accepted and the cost of recovery will



likely grow at a rate commensurate with that of the descent. The result of this vicious spiral will be lost developmental capability and degraded support to fielded systems.

Several recommendations have been suggested that address the strategic issues facing PEO, Missiles and Space. To recover or to intervene from the vicious spiral the PEO has entered will probably require external assistance necessary to reverse the trends and cues signaling industry. The recommendation in this area is to develop a detailed cost benefit analysis that takes into account and describes the risk that knowingly or unknowingly has been accepted. Additionally, scenario analysis may be a useful tool to capture and quantify the costs associated with a shrinking technological gap between the US and adversaries. By characterizing the issue in this cost benefit format, more informed decisions as to priorities of funding can be made.

In summary, this research was initiated based on strategic issues identified by PEO, Missiles and Space in April 2006. These issues were believed to have some common characteristics with other organizations within the DoD—making their investigation a worthwhile endeavor. The use of a flexible analytical tool enabled these strategic issues to be characterized and led to four conclusions and several recommendations that could assist PEO, Missiles and Space or other organizations.



THIS PAGE INTENTIONALLY LEFT BLANK



ACQUISITION RESEARCH PROGRAM
GRADUATE SCHOOL OF BUSINESS & PUBLIC POLICY
NAVAL POSTGRADUATE SCHOOL

I. INTRODUCTION

A. PURPOSE

BG Samuel Cannon, PEO, Missiles and Space, authored a White Paper (Bogosian & Cannon, 2006, April 30) informing the Office of the Assistant Secretary of the Army (Acquisition, Logistics, and Technology) of a “looming crisis regarding personnel necessary to support Army and Joint programs managed at Redstone Arsenal.” The crisis is being precipitated by the coincidence of the following four initiatives or strategic issues: (1) Program Budget Decision 753, (2) deterioration of the matrix support base, (3) the aging workforce, and (4) influx of new organizations as a result of the most recent BRAC decisions. This paper researches and analyzes those strategic issues and develops conclusions and recommendations that may assist the organization in terms of strategic thinking and decision-making.

Therefore, the purpose of this research was threefold:

1. Describe and analyze the complex interaction and planning centered on the four *strategic issues* facing the Army Program Executive Office (PEO), Missiles and Space Command, Redstone AL. A strategic issue is a “fundamental policy question or challenge affecting an organization’s mandates, mission, and values; product or service level and mix; clients, users, or payers; or costs, financing, structure, or management” (Bryson, 1995, p. 20).
2. Describe and analyze aspects of these issues to assist PEO, Missiles and Space leaders and managers in terms of identifying and resolving these important issues, i.e., focused data collection, stakeholder analysis, generation of alternatives, and recommendations.
3. Provide scientific observations and data points to the DoD, the United States Army and the Army Acquisition community regarding the strategic issues confronting acquisition commands today and how they are attempting to resolve the issues and maintain their position as a viable acquisition program office.



B. SCOPE

The focus of this research was limited to the strategic issues facing PEO, Missiles and Space and the issues discovered during research which are relevant to PEO, Missiles and Space, the Army Acquisition community and the DoD. The research analyzed the issues over a limited period of time beginning with the release of *PBD 753* through the publication of this report.

C. METHODOLOGY

The methodology used for this professional report included literature reviews of the Army budget process, the aging of the workforce and Base Realignment and Closure. The primary method of data collection was through the use of semi-structured interviews with nearly a dozen members of PEO, Missiles and Space during a site visit and through multiple teleconferences and e-mail exchanges. These members included the senior leaders of the organization and mid-grade managers. (See Appendix A for interview questions). Due to the complex nature of the data collected, the Organizational System's Framework model was employed as the analytical tool to better understand these interactions at PEO, Missiles and Space, and to frame conclusions and recommendations.

D. RESEARCH QUESTIONS

1. Primary Research Question

What is the nature of the complex interaction and planning centered on the four strategic issues (Program Budget Decision 753, deterioration of the matrix support base, the aging workforce, and the influx of new organizations as a result of the most recent BRAC decisions) facing Program Executive Office Missiles and Space?



2. Supporting Research Questions

Who are the major stakeholders impacted by *PBD 753* (and other major issues)? What do they have at stake, and how can Missiles and Space influence the issue positively?

What are the reasons behind a deterioration of the current matrix-support structure, and what are the alternatives to resolve the unintended consequences of that deterioration, including personnel processes?

How can Missiles and Space command learn more about the influx of new organizations (and personnel) resulting from BRAC, and how can the command positively affect the issue?



THIS PAGE INTENTIONALLY LEFT BLANK



II. BACKGROUND

A. OVERVIEW

This chapter describes the organization of the PEO, Missiles and Space. It outlines the mission, goals, capabilities, tasks and structure of the organization. Additionally, this chapter presents background information on the four strategic issues of initial concern identified in the Perfect Storm and how those issues are relevant to this research and to PEO, Missiles and Space. Finally, a detailed description of the Organizational Systems Framework Model is provided in order to understand how the analytical tool was utilized to evaluate the strategic issues central to this research project.

B. PEO, MISSILES AND SPACE

Program Executive Office (PEO), Missiles and Space is the Army's lead organization for the lifecycle management of missile systems. Its mission is to provide an unprecedented level of service and support for PEO, Missiles and Space weapons systems (PEO, Missiles and Space, 2007a, p. ii). In this capacity, it is responsible for the development, acquisition, and sustainment of assigned warfighting systems. The PEO is currently assigned and tasked to support programs that span four Battlefield Operating System (BOS) elements—including infantry, aviation, field artillery, and air defense artillery. Additionally, the supported programs cover the full spectrum of the acquisition lifecycle, with some programs in the early stages of development while others are nearing retirement and disposal.

PEO, Missiles and Space has six goals representing how it intends to successfully accomplish its mission, including meeting all the responsibilities it has been charged with.

- Support the warfighter in current operations



- Excel beyond all others in fielding the best rocket, missile and space systems in the world
- Effectively team with industry
- Mature and weaponize critical technologies for the future force
- Reduce the lifecycle cost of our systems and in-theater logistics footprint
- Build the Army acquisition corps of the future

Supporting the warfighters in current operations means ensuring they have safe, reliable, effective weapon systems. This requires the PEO to accurately translate the end-users' need expressed in a Capabilities Development Document (CDD) into a supportable weapon that provides the requested capability. Additionally, current operations may require timely changes or modifications to the program. Production quantities may need to be increased or product improvements accelerated to provide the support required. Meeting the warfighter's immediate need is a critical task for the PEO and one that represents significant challenges. Advances in missile technologies continue to push weapon systems forward by providing increased capabilities with each increment. These advances are not only taking place within the United States, but also abroad. PEO, Missiles and Space must strive to stay ahead of potential rivals in system development. In order to accomplish this, it must effectively accomplish the next two goals of teaming with industry and maturing and weaponizing the critical technologies required for the future force.

A dynamic relationship exists between the government and industry. When the relationship is working well, the efforts of both are synchronized and focused toward a common goal. When it is not, resources are expended inefficiently, and neither side is satisfied with the result. The better the relationship, the more likely the users' needs will be met in timely manner. In order to mature the technologies for the future force, industry must be involved. Its involvement with identifying where advances are taking place can help shape the acquisition strategy. By fostering a



good relationship with industry, the PEO gains the unity of effort necessary for effective development of systems. Another way the PEO brings about efficiencies is by addressing lifecycle costs and logistical considerations. The PEO must consider all the costs of a system throughout its lifecycle—not just its developmental costs. Likewise, it must also consider the logistical tail required to support the system. The failure to take these considerations into account could result in a system requiring more resources during the sustainment phase of the acquisition lifecycle than necessary. The more resources spent on operating and maintaining existing systems, the less available for improvement or development of new systems. The final goal necessary for the PEO to effectively accomplish its mission is to ensure the development of the acquisition corps members who will be responsible for acquiring the future force. By putting in place a training and education plan for grooming future leaders, the acquisition corps will continue to improve and effectively accomplish its mission

Accomplishing the goals required to meet its mission requires significant resources. In order to provide the required “cradle to grave” support it has been tasked with, PEO, Missiles and Space employs approximately 1,400 personnel. The personnel are organized into seven Project Offices that have been tailored to support a specific subset of the PEO’s programs that are generally focused on a particular BOS element. Although the Project Offices vary in exact composition and organization, each contain personnel of similar disciplines that come from the three general personnel pools of Core, Matrix and Systems Engineering and Technical Assistance (SETA) contractor support. The Project Offices organize the personnel from these personnel pools in the most efficient manner based on the lifecycle phases of its supported programs. Project Offices with more developmental efforts taking place will have a larger number of engineering-focused personnel, while more logistics-oriented personnel are required for Project Offices supporting systems in the sustainment phase. The organizational chart (Figure 1) of PEO, Missiles and Space is included below. A listing of the PEO supported programs can found at www.msl.army.mil (PEO, Missiles and Space, 2007b).



PEO Missiles and Space Organization

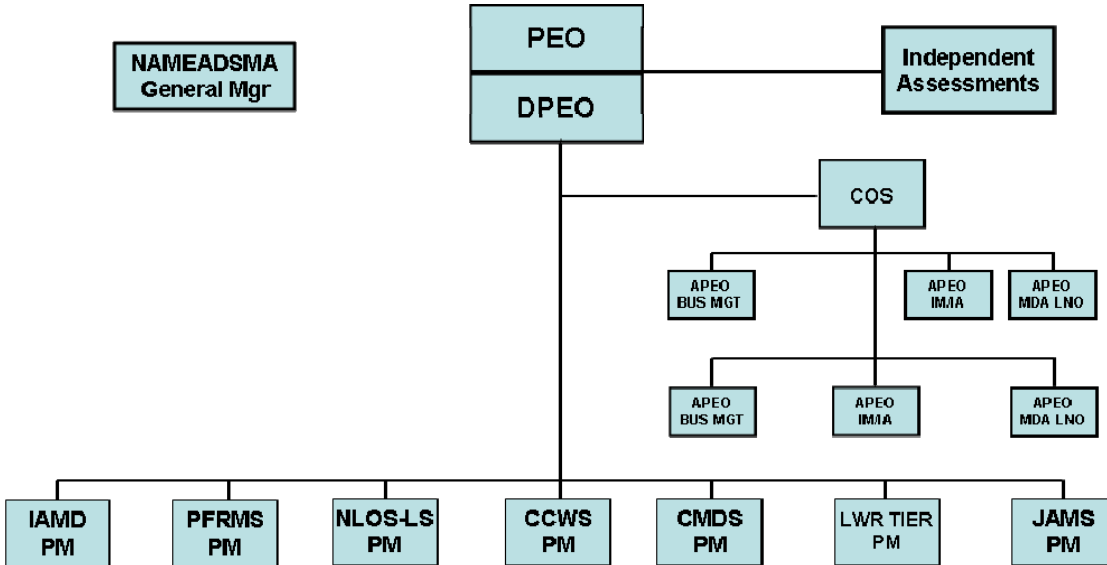

Figure 1. Organization chart, PEO, Missiles and Space
(PEO, Missiles and Space, 2007a)

C. DEFENSE BUDGETING AND PROGRAM BUDGET DECISIONS

The Department of Defense uses the Planning, Programming, Budgeting, and Execution System (PPBES) to prepare its budget. Resource allocation, planning, policy implementation and managing a budget of this size and magnitude required the development or need for a formalized system. At any given time, the Pentagon is planning, preparing and executing three different budgets. The PPBES has four distinct and different phases that overlap, making it essential for an agency to keep up with what is going on in the previous or next phase. The first phase is planning. It is in this phase that the initial steps are taken to develop the plan for the budget; this begins in the Executive branch with plans to layout a national defense strategy. It is in this phase that the Secretary of Defense submits the Defense Planning



Guidance (DPG). The DPG is the official guidance from the Secretary to the services on how they should prepare their Program Objective Memorandums (POM) (Jones & McCaffery, 2004, pp. 97-99).

The second phase is programming. The goal is for each military component to design a POM that will answer how it plans to spend monies over a six-year period. The POM must address fiscal restraints; it must support the Combatant Commander's unrestrained Integrated Priority Lists (IPL), and it must support the guidance given by the Secretary of Defense in the DPG. Additionally, the POM must meet the fiscal restraints as laid out in the DPG (which are total obligations by military department by year) because POMs are developed in even-numbered years and reviewed in the odd-numbered years. The POMs are reviewed by the Joint Chiefs of Staff (JCS) to ensure compliance with national strategy and the DPG, and to ensure that they also meet capability requirements and addresses force levels. Following the review by the JCS, the Chairman issues the Chairman's Program Assessment (CPA) to assist the Secretary of Defense in the development of the Program Decision Memorandum (PDM). The CJCS also provides recommendations and alternative solutions and budget proposals for the Secretary of Defense to consider prior to his issuing the Program Decision Memorandum (PDM). The PDM adjusts or approves programs in the POMs. The approved or amended POM is the baseline document in which departments will submit their budget inputs (2004, pp. 100-101).

For acquisition matters, CJCS is assisted in his advisory process by the Joint Resources Oversight Committee (JROC). The JROC is chaired by the Vice-Chairman of the Joint Chiefs and is staffed by the Vice-Chairs of all services. The JROC reviews all joint acquisition programs or those in which a common interest has been established. A program that has been deemed to meet joint requirements is labeled a priority by the JROC and is added into the POM and, further, the budget for funding. Successful vetting and staffing of joint programs at this level may take up to six months (2004, pp. 101-102).



The third phase is budgeting. This begins with approved programs in each POM. The items that support the POM are “cost out” by each military component for that budget year, and each component submits each part of the budget as a Budget Estimate Submission (BES). In the even numbered POM years, the BES is a two-year submission. It is factored on the first two years of the POM as adjusted by the PDM. The services amend the BESs during the odd-numbered years POM update, and they cover just one year. The military secretaries under the authority of military department secretaries review each and every BES. The DoD Comptroller, various OSD officials, the JCS, Deputy Secretary of Defense and, finally, the Secretary of Defense review the budgets of the military department secretaries. This review is conducted along with the President’s Office of Management and Budget. This is to ensure compliance with DPG, PDM and the National Security Strategy. The Secretary of Defense makes all necessary changes and provides the rationale for each change in the form of the Program Budget Decision (PBD). The PBD is to allow the secretary of each military department the time to submit appeals back to the Secretary of Defense and the Office of Secretary of Defense Comptroller. Program Budget Decisions are coordinated with all of the stakeholders on a particular issue. Through this review process, all perspectives—including those of the Chairman of the Joint Staff, Under Secretaries of Defense, Service Secretaries, and the OMB—are considered as an integral part of the decision-making process. The Deputy Secretary of Defense considers the PBD and also the responses prepared by all interested parties. Once decisions have been made on any issues identified by the Comptroller or OMB, the Defense Components are given an opportunity to resolve the issues with OUSD(C) as an out-of-court settlement or, subsequently, to appeal directly to the Secretary of Defense for final resolution (DoD Comptroller, 2007a) After final resolutions, the final defense budget is forwarded to OMB for submission as part of the President’s Budget (Jones & McCaffery, 2004, pp. 101-102).

The final phase is execution. This phase begins by requesting permission to spend congressionally approved appropriations. The DoD must describe how it is



going to spend the appropriations, the month, the quarter or by-year for multi-year appropriations. The appropriations must now be attributed to individual programs and further allocated into the months in which they will be spent. Once the Treasury and OMB receive the allotment approvals, the DoD begins the process of distributing the share of the budget to the different departments, agencies, and DoD commands. Then, the organizations begin to obligate and spend the allocations through the outlays of monies. This process is monitored by comptrollers at all levels of the DoD. By the end of September (fiscal year's end), all accounts must be reconciled and all appropriations and spending accounted for prior to closing the accounts (2004, p. 102).

The Budget process and the generation of the PBD is important for this research due to the fact that *PBD 753*, published 23 December 2004 and announced in January 2005, initiated an Army activity to gain program reductions in order to fund other priority Army initiatives. PEO, Missiles and Space's part of those reductions were approximately \$360 million to be realized over the FY 2006-2011 period. This amounts to an average reduction of about \$60 million per year. Additionally, these reductions were targeted at the elimination of contractor support jobs.

D. THE AGING WORKFORCE

As mentioned above, the aging of the workforce has been a growing concern—not only within the DoD but also within the commercial industry. In the United States today, there are approximately 22.8 million people aged 55 or over who are working. They comprise approximately 16 percent of the workforce. The number of workers aged 55 or over is growing approximately 4 times faster than the workforce as a whole. Because of the relative size of their group, as the Baby Boomers age, they will have a disproportionate impact on the overall age distribution of the nation's population in general and the workforce in particular. Baby Boomers, who in 2007 will range in age from 43 to 61, currently represent nearly 50% of the US workforce. This is slightly more than the combined numbers from the



succeeding two generations (Generation X and the Millennial Generation) (Ernst and Young, 2006, January, p. 8).

The importance of understanding the issue of an aging workforce is because PEO, Missiles and Space like any other organization, government or commercial, must develop effective strategies to confront these concerns. The PEO has estimated that as much a half of its workforce is eligible to retire by FY 2008 and over three quarters by FY 2010. The PEO cannot make a prediction as to exactly how many will retire, but it feels that based on current trends as many as 50% of those eligible will retire. For the purposes of this project, it is important to understand that the issue does exist and that the organization has recognized it as a strategic issue (Bogosian & Cannon, 2006, April 30).

E. BASE REALIGNMENT AND CLOSURE (BRAC)

BRAC, officially known as the Defense Base Realignment and Closure Commission, is the process used by the DoD and Congress to close excess military installations in order to save money on operations and maintenance and to achieve maximum efficiency in line with Congressional and DoD objectives. The process begins when the Secretary of Defense submits a list of military installations to be closed, shrunk, enlarged or realigned. More than 350 installations have been closed in four BRAC rounds: 1989, 1991, 1993 and 1995. The most recent round of BRAC completed in the fall of 2005 and, with the commission's recommendations, became law in November of 2005. The BRAC process was developed in an attempt to achieve the government's goal of closing and realigning military installations despite the political challenges which often arise when facilities face reduction or elimination. The process has varied through the iterations slightly, but the objective has been fairly constant. Because a military base can bring millions of dollars in federal money to its surrounding area each year, challenges raised by members of Congress from affected districts make such initiatives very difficult. Congress created the BRAC process in 1988 as a politically acceptable methodology to pursue such needed goals. Following the submission by the Secretary of Defense, an



independent commission (the BRAC Commission) evaluates the list by taking testimony from interested parties and paying visits to affected bases. The BRAC Commission has the opportunity to make changes to the list. The commission then submits its list to the President, who approves or disapproves the list in its entirety. The list then goes to Congress for action. Congress has 45 days to disapprove the entire list, otherwise BRAC recommendations are final (Defense Base Closure and Realignment Commission, 2007).

The latest round of BRAC decisions approved by the President on 15 September 2005 is going to have a significant impact on PEO, Missiles and Space. According to the PEO, as many as 4,700 Government jobs and 5,000 contractor jobs will be moving to the Redstone Arsenal area (Bogosian & Cannon, 2006, April 30). Redstone Arsenal will see significant gains, as this installation will be the new home to the Army Materiel Command (AMC) headquarters, the Space and Missile Defense Command (SMDC) headquarters as well as significant assets from the Missile Defense Agency (MDA). At the time of the BRAC deliberations, the arguments to relocate these organizations to Redstone Arsenal were: 1) Cost savings, 2) the collocation of units with similar missions, 3) enhanced jointness between MDA, SMDC, the Aviation and Missile Command (AMCOM), and NASA's Marshall Space Flight Center, and 4) an established Missile Defense Center of Excellence. Additionally, the political decisions to relocate organizations were made under the assumption that the positions of those individuals who chose not to relocate with their organization would be filled by the local community. To PEO, Missiles and Space, this is more competition for the already highly sought after skilled professions such as: 1) Rocket and Missile Engineers, 2) Propulsion Technology, and 3) Program Management.



F. ORGANIZATIONAL SYSTEM'S FRAMEWORK MODEL

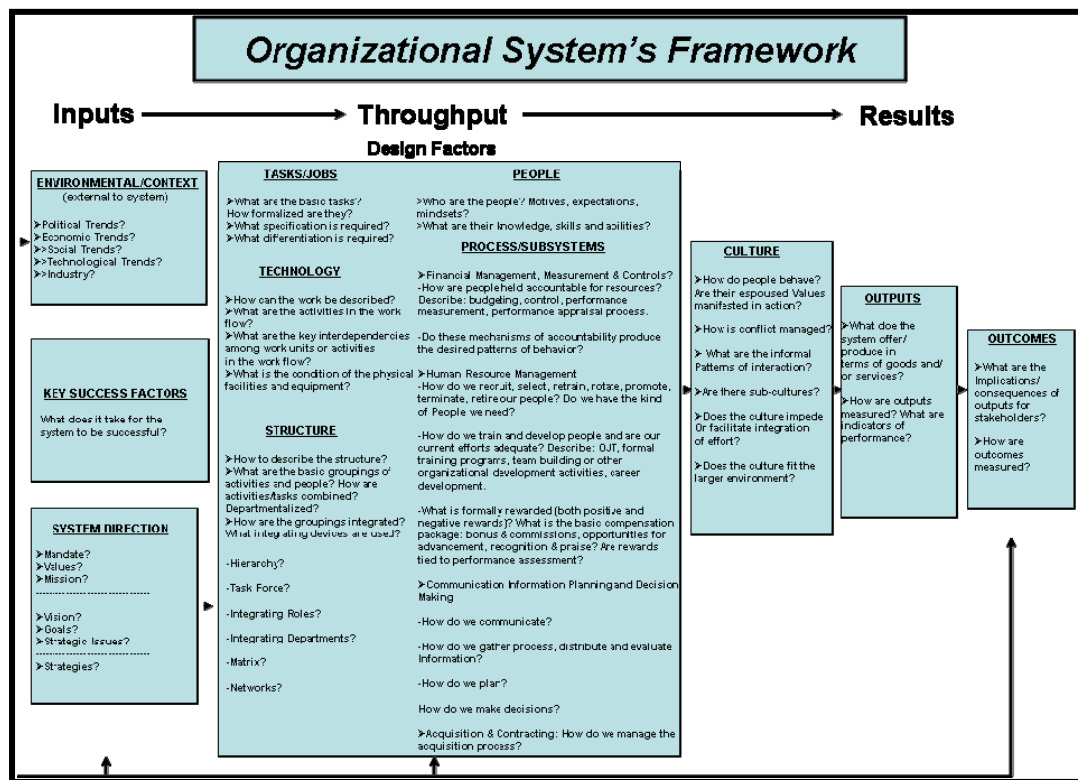

Figure 2. The Organizational System's Framework
(Roberts, 2003)

The Organizational System's Framework model describes an organization as a system, and it assists in prescribing changes in the design factors. A model is nothing more than an analytical tool to help us describe highly complex organizations. The system's perspective is based on several overarching assumptions and that an organization is open to its external environment. The boundary that separates an organization from its environment is permeable, meaning there is dynamic interaction between internal organizational variables and external factors—i.e., congressional oversight decisions affecting hiring decisions. The ideal is to keep the organization in dynamic equilibrium with its environment by ensuring key variables "fit" or are in congruence. As the environment changes, organizations adapt to survive. Of course, organizational changes can likewise impact the external environment. We must clearly acknowledge, however, that



mutual adaptation between the organization and its environment isn't guaranteed. Using a model must be done carefully and with the full understanding of its capability to effect positive change. A model can not be expected to capture all of the complex relationships influencing an organization. Therefore, managers should anticipate that their changes may have unintended consequences—making the adoption of a less conservative change style more desirable.

Organizational survival and viability can be described as a dynamic process of converting external, input and design factors into various organizational results (outputs and outcomes). Because defense organizations face a plurality of stakeholders (external and internal) with different goals and objectives, stakeholder perceptions and evaluations are a substantial part of the “bottom line.” With positive stakeholder views, an organization might choose to maintain the status quo. Likewise, as stakeholders perceive poor performance, either the organization adapts and changes direction or becomes irrelevant (bankrupt in the private sector). The point is when and what types of corrective interventions apply. Intervention can involve incremental changes (continual process improvement), transitional changes, and transformation (system-wide change). Interventions create ripple effects where cause-and-effect may not be close together in time and space. Misaligned parts reduce system efficiency and effectiveness (Roberts, 2003).

The following paragraphs further describe each critical element and sub-element within the model.

1. Environment/Context

According to research conducted by Grandrath at the Naval Postgraduate School, environment refers to external environmental forces and trends. The external environment influences the organization through the actions of people, social influences and politics, technological and economic forces, and legal considerations. The environment often makes demands on the organization and imposes restrictions on the organization’s actions. At the same time, the



environment offers realistic opportunities for the organization to be successful (Grandrath, 2000, p. 23).

In addition to the external environment, context can be described as the organization's view of its current situation in relation to its historical, political and social perspectives. The historical perspectives of an organization might provide insight on how it is likely to respond to environmental turbulence. Past leadership values and actions, cultural response to threatening events and trends, and the role of organizational values all contribute to how an organization will perform.

2. Key Success Factors

Key success factors are the critical indicators against which an organization must demonstrate at least adequate performance if it is to prosper and grow. The specific factors will differ for each organization and are often larger in number and inherently more unclear for public organizations than for bottom-line-oriented private organizations (2000, p. 25).

3. System Direction

System direction is a leadership process that informs all relevant stakeholders as to the future direction or strategy of the firm. Direction setting is perhaps the first charge of leadership, in terms of was a direction set, and does the direction fit with external forces and trends? System direction is determined by the following critical attributes (2000, p. 25):

a. Mandate

Mandates are both formal and informal requirements on what to do (and not do) from external authorities (2000, p. 26). Mandates are things the organization must and should do.

b. Values

The values of an organization are part of a belief system meant to shape and guide behavior. Underlying organizational values are meant to assist in decision-



making and to settle disputes. Values are typically part of an organizational philosophy of operations and help explain how personnel approach their work, manage internal issues, and relate to their external environment. Values can differ between organization elements and individual values (2000, p. 26).

c. Mission

Mission is the stated purpose or reason an organization exists.

d. Strategic Issues

Strategic issues are core policy questions that affect an organization's mandates, values, or mission (2000, p. 26).

e. Vision

A vision can provide clarity of an organization's direction and purpose. A vision can specify success in terms of mission, core values, basic strategies, goals and performance factors, ethical conduct and important rules for decision-making. A vision can highlight a path to success (2000, p. 26).

f. Goals

Goals are known to motivate human behavior. Similarly, specific, measurable, attainable, realistic and timed goals can motivate and concentrate the efforts of many employees. The identification and obtaining of organizational goals is a useful criterion for determining leadership effectiveness and organizational performance.

g. Strategies

Strategy specifies the direction of the organization in terms of mission, values, goals, and objectives. The pattern developed by organizational policies, programs, actions, decisions, and resource allocation can define a strategy. Strategy is usually the first organizational component to be addressed because it establishes the measurements for choosing among alternative organizational forms (2000, p. 27).



4. Design Factors

Organization design factors refer to the individual elements and structure of the organization. Grandrath asserts design factors typically reside in the management domain—i.e., managers intervene in terms of structure, processes, people, tasks and technology. Again, the central hypothesis of systems thinking and acting is the fit or congruence of the variables determines performance. For example, if a university institutes distance learning using video-teleconference technology, but professors refuse to use it, then the misfit indicates the likelihood of poor performance.

a. Task Jobs

This comprises the work of an organization or the tasks that are to be done by the individuals, groups or by the organization as a whole. The jobs that the organization does are constructed and formed around these tasks.

b. Technology

Technology is the physical and mental processes used to convert inputs into manageable outputs—i.e., how the core work gets done. Technology in this context is much more than the devices and equipment used by the individuals within the organization, but includes also their knowledge and activities within and about the organization. Technology can affect the actions of individuals within the organization and how it operates. Increasing technology levels often leads to more efficient and effective organizational processes—which leads to a better flow of inputs into outputs (2000, p. 30).

c. Structure

Structure within an organization refers to the way the organization arranges individuals and groups concerning the jobs or duties they will perform—including how the work will be coordinated. Groups and teams, functional and client-based divisions, and matrix relationships are examples of organizational structure. Structure also includes decision-making and communications structure, both of which managers have some control over.



d. People

There have been numerous studies concerning leaders, managers and followers, particularly in terms of achieving productive relationships. Whom the firm hires, promotes, removes and retains obviously impacts organizational performance. The ability to understand and influence human strengths and weakness, organizational members' motivations and needs is paramount according to most scholars and practitioners (2000, p. 32).

c. Processes/Subsystems

The processes and subsystems are the elements that weave the organization design factors together.

Financial Management, Measurement and Controls

Financial management, budgeting, accounting, and other control mechanisms are fundamental processes of organizational management.

Human Resource Management

Human resource management includes all policies dealing with recruitment, selection, retention, promotion, training and education required to develop the workforce that can achieve the goals formulated by management. It forces the organization to look internally to determine if the people are the right mix. This also includes the rewards program that provides motivation and incentives for the achievement of goals. The purpose of a reward system is to align both the employees' goals and the goals and direction of the organization.

Communication, Information, Planning, and Decision-making

This is the process for determining how the organization communicates both internally and externally. Internally, it determines how the organization communicates both up and down the communication network. This communication



decision also includes the gathering and processing, distribution and evaluation of information, planning and decision-making.

Acquisition and Contracting

The acquisition and contracting process is how the organization acquires goods and or services from outside sources.

5. Culture

Organizational culture describes how people within the organization interact with each other and their stakeholders—i.e., the way of life for a group of people. Grandrath also explains that culture can be a direct growth of an organization's values and beliefs, or a far cry from espoused values. Values form the basic core positions of right and wrong at human, organizational and societal levels. Culture often runs-deep and is slow to change. Culture is an emergent variable developed over time and can be both an organizational strength and/or weakness.

6. Outputs

Outputs are what the organization produces, normally in terms of goods and services. Outputs may be visible indicators of organizational success (e.g., exploding Starbucks growth). Outputs can be described in terms of three factors. How successfully does the organization meet strategic objectives? How successfully does the organization use its scarce resources? Last, how successful is the organization at positioning itself to seize opportunities and ward off threats presented by the environment (2000, p. 32).

7. Outcomes

Outcomes are the consequences of the outputs, including intended and unintended consequences. They are typically more important, yet harder to measure than outputs. For example, an output of additional submarines and strategic bombers might not have the intended consequence of defeating asymmetric US enemies.



G. CHAPTER SUMMARY

This chapter discussed the critical issues that contributed to the development of the Perfect Storm described in Bogosian and Cannon's White Paper and were the focus of this research. For several years, generally accepted wisdom is that many organizations in the United States Army have been asked to do more with less and to make reductions where reductions were once unimaginable. Now it appears that the Perfect Storm has arrived at the doorstep of PEO, Missiles and Space, requiring strategic thinking and acting to resolve identified issues. This chapter outlined the fundamental analytical systems model as a way to describe all the major factors associated with organizational performance, particularly the strategic issues confronting PEO, Missiles and Space. The understanding of this analytical tool will enable the findings and analysis presented in Chapters 3, 4 and 5 to follow.



THIS PAGE INTENTIONALLY LEFT BLANK



III. FINDINGS AND ANALYSIS SYSTEM INPUTS

A. OVERVIEW

An accepted logical method of presenting analysis findings is by organizing key variables using the theoretical foundation contained within systems thinking, e.g., the Organizational Systems Model. This chapter presents findings obtained during the research process according to the input section of the systems model. Subsequent chapters will address the findings related to the throughput and results sections of the model. The external environment/context, key success factors and system direction are addressed to describe PEO, Missiles and Space functions, and to provide an understanding of how changes to these elements of the model may positively or negatively impact the overall system. Following the presentation of findings as they relate to a particular element of the model, analysis of these findings will be conducted. The analysis summarizes the elements as they relate to the primary research question and provide a basis from which conclusions and recommendations can be drawn.

B. FINDINGS: ENVIRONMENT/CONTEXT

1. **Political**

The first findings to be addressed are those relating to the environmental/context elements of the Organizational Systems Model. As described in Chapter Two, these are factors that lie primarily outside PEO's boundaries, but which can impact its operation— e.g., political, economic, social, and technological elements. In the conduct of the research, four major findings were discovered that related to political factors. The first was the challenge facing PEO, Missiles and Space in gaining political support for their Perfect Storm argument due to political capital spent during the most recent BRAC cycle. Where the Perfect Storm argument warns of a “looming crisis regarding personnel necessary to support Army and Joint programs managed at Redstone Arsenal” (Bogosian & Cannon, 2006,



April 30), the arguments made during the BRAC decision analysis were quite the opposite. In the political process that led up to the 2005 BRAC decisions, elected officials were successfully convinced the area had sufficient human resources to support not only all existing organizations, but also additional personnel requirements resulting from the influx of new organizations. On the surface these two arguments, Perfect Storm and BRAC, would seem to be in direct conflict with each other—making it very difficult for PEO, Missiles and Space to find support in political channels. Getting the same political figures that successfully used the available human resources in the local area as strength in the BRAC argument to now support an argument that highlights a personnel challenge is not likely. As the researchers discussed the political aspects of the Perfect Storm with the senior leadership of the PEO as it relates to BRAC, the respondents identified some key points necessary to put the arguments in perspective. The first is that on the whole, BRAC is expected to be fully supportable by the human resources available in the Redstone Arsenal area. Of the approximately 4,700 Government and 5,000 support contractor jobs transitioning to the area from 2007-2011, most will be easily filled by qualified personnel. There are, however, some highly technical positions in which this may not be the case. These specific positions will be highlighted later when discussing the design factors of the systems organizational model. The political challenge now facing PEO, Missiles and Space is in how to successfully craft a personnel argument which focuses on these limited positions that does not give the appearance of poor analysis in the BRAC decision. The PEO is currently framing this argument in a manner that will be more politically supportable.

The second political factor in the external environment is the recent change in control of the Congress as a result of the November 2006 elections. The effects of this change are difficult to predict; but at a minimum, funding priorities will be reviewed and past decisions positively or negatively affecting PEO, Missiles and Space could be revisited. With the control of the Arms Services and Appropriations Committees changing hands, new relationships will need to be cultivated. How successful the Army Staff and PEO, Missiles and Space are at fostering these



relationships could make additional courses of action available or could close some approaches previously open to the organization. The changes to the President's budget submitted in February 2007 will indicate how effectively these relationships are being managed. If the systems assigned to PEO, Missiles and Space receive higher-than-requested funding levels, this could indicate a more supportive environment; if they receive less, it could indicate less responsiveness to its Perfect Storm issues.

The third factor in the political element of the environment is the Global War on Terror. In this area, there are two competing findings that relate to PEO, Missiles and Space. The first is that the systems managed by the PEO have by all accounts performed well during the execution of the wars in Afghanistan and Iraq. Although the majority of the systems have only seen limited use due to the type of warfare being employed in the current operational environment, they have provided the required capability when necessary. The successful track record favors the PEO, but the current operational environment does not. Politically, there is strong pressure to provide the warfighter with what he needs right now, but less pressure on developing what he might need tomorrow. With this dynamic in play, the systems managed by PEO, Missiles and Space may be seen politically as "good enough" in the current environment. The more difficult argument the PEO is left with, at least politically, is that the required capabilities for future conflicts are not being resourced. The capabilities necessary to defeat more technologically advanced adversaries such as North Korea, China or members of the former Soviet Union are not the focus of current political discussions. Although the nations that represent these potential threats may see this as an opportunity to close the technological gap between themselves and the US, it is still a difficult argument for the PEO to make.

In a highly competitive political environment, the best way to interpret the prioritization of an effort is by evaluating its level of resourcing—which brings this discussion to the final political component of the researchers' findings: funding decisions. These politically motivated resourcing decisions may be the single



largest external factor impacting the PEO, Missiles and Space. Of the four major initiatives identified as contributors to the Perfect Storm, *PBD 753* is the most directly tied to these decisions and likely the most difficult to mitigate internally. As stated in the previous paragraph, significant political pressure exists to ensure the warfighter receives the resources necessary to execute current operations. Decisions such as *PBD 753* reflect this prioritization, but at the expense of other priorities. In the case of PEO, Missiles and Space, *PBD 753* resulted in requirements to return approximately \$360 million over the FY06-11 timeframe. The plan for meeting these cost objectives was briefed to the Department of the Army Staff in April 2005 and involved the elimination of support contractor positions and reductions in funding for the Guided Multiple Launch Rocket System (GMLRS) production line.

The changing of priorities from year to year can also result in programmatic changes to systems and technologies being developed. If additional funding is required to meet requirements in more immediate years, then risk may be accepted by taking funding from developmental systems and applying them toward the more immediate requirements. In recent years, PEO, Missiles and Space has seen its assigned developmental systems identified as areas in which risk could be accepted. The President's Budget submitted in February 2007 continued this trend as the Advanced Precision Kill Weapon System (APKWS), Army Tactical Weapon System (ATACMS), and Joint Common Missile (JCM) programs were eliminated; \$250 million was taken out of the Medium Extended Air Defense System (MEADS) program, as well (Assistant Secretary of the Army, 2007). BG Cannon indicated he did not believe the Army Staff understood exactly how much risk they were accepting by making these decisions. This point will be further expanded upon when this study discusses findings regarding the technological aspects of the external environment. (See Figure 3.)



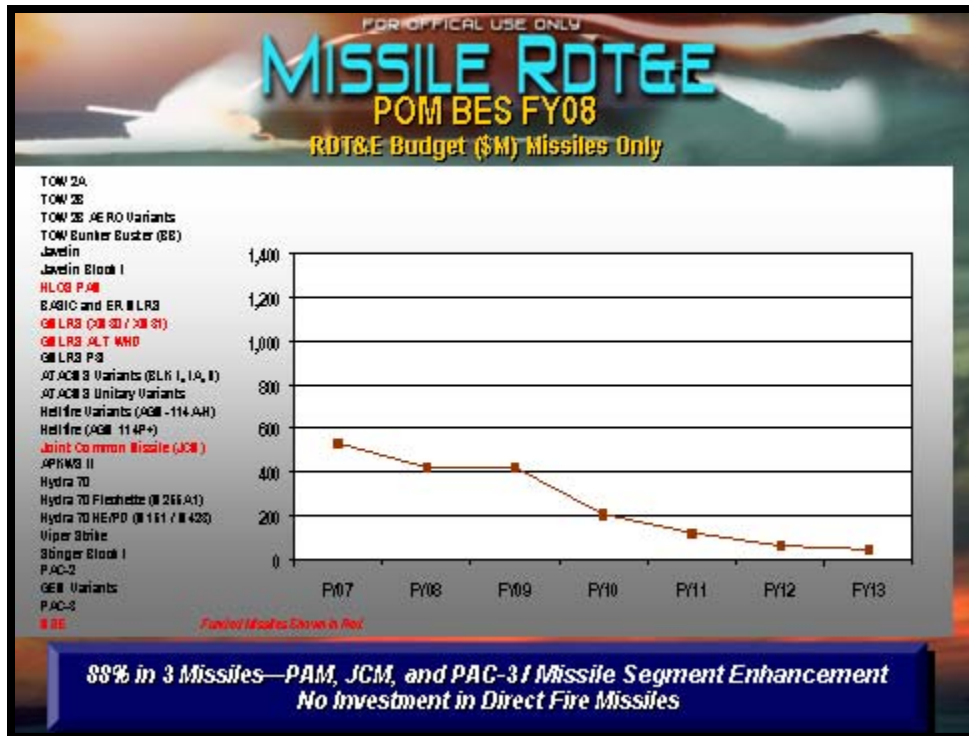

Figure 3. Missile RDT&E
(Program Executive Office, Missiles and Space, 2007, February)

2. Economic

The economic component of the external environment is the national economy and the fiscal health of our nation. Although the political priorities mentioned in the previous section identify where the spending goes, the economic component plays a significant role in determining how much there is to spend. While the national economy continues at reasonable growth levels, trends in how the funds are allocated also continue along a trend line. As depicted in the graph below (Figure 4), defense spending has continued on a downward trend, while nondiscretionary spending has continued to account for more and more of the total percent of federal spending. What this illustrates is that the nation has taken on responsibilities in the form of nondiscretionary spending that, unless changed, will require changes to economic policies, or more difficult prioritization decisions concerning discretionary funds.

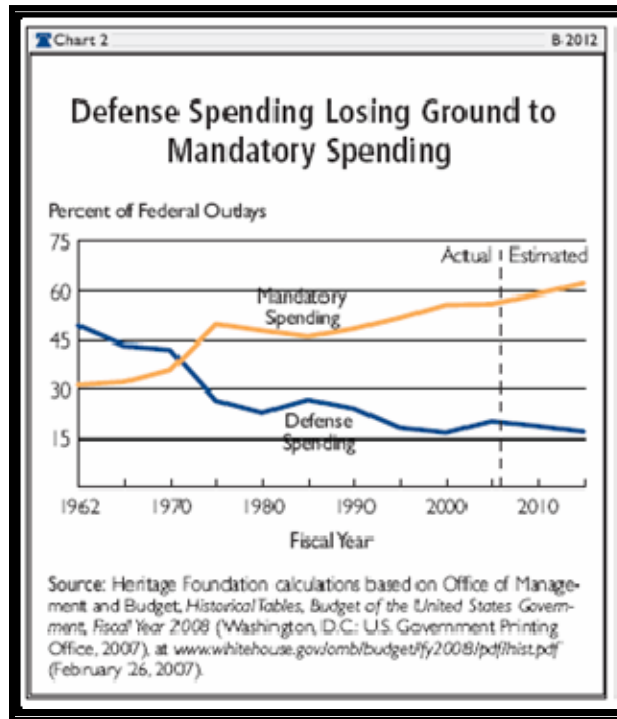

Figure 4. Defense Spending vs. Mandatory Spending
(Heritage Foundation, 2007)

In the second chart (Figure 5), the comparison is made to funding levels of previous conflicts and wars measured as a percent of GDP. Even with the slight increase in funding during the initial years of the GWOT, the funding levels are still below those provided during any past efforts and even the peacetime spending levels of most previous years. What these national trends mean to PEO, Missiles and Space is that unless the economy grows at an exceptionally faster rate, overall defense budgets will continue to decline—provided political priorities remain the same.



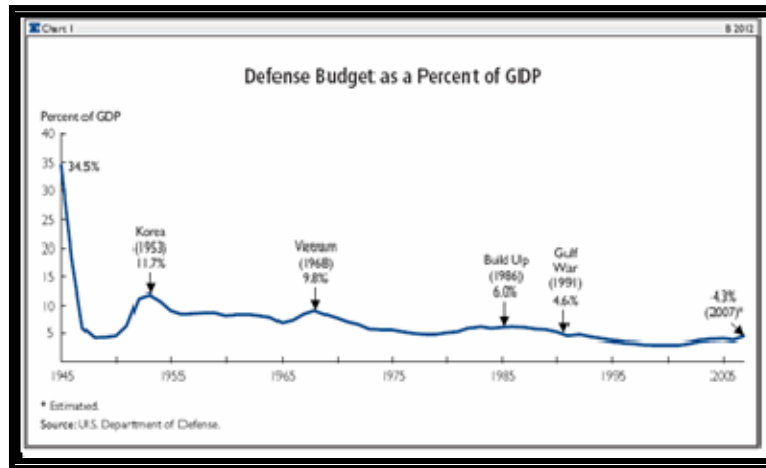

Figure 5. Defense Budget as Percent of GDP
(Department of Defense Comptroller, 2007b)

3. Social

The primary social element of the external environment is the aging workforce. As the “Baby Boomer” generation ages, many social changes are likely to take place. Several of these changes may have direct and indirect impacts on PEO, Missiles and Space. There are two changes relative to the research and analysis of this project. The first is that workers will remain in the workforce for longer periods of time. This will directly impact the PEO in terms of the demographics of their workforce. Some of these factors will be discussed later in analysis of the design factors. Indirectly, an aging population will affect the economic and political elements of the external environment of the PEO. The second change relative to the aging workforce is related to the expertise held by these employees: what changes are necessary to retain them. As Nancy Lockwood writes in her article, “To retain older workers with their experience and knowledge base—and offset the skilled labor shortage—legislative changes must be made to allow older workers to continue to work, or return to work, without financial penalty (e.g., changes in social security, pension plans, IRS regulations)” (Lockwood, 2003). This challenge for PEO, Missiles and Space is compounded by its limited ability to offer incentives to its employees in these skilled labor positions comparable to those offered by industry.



The final social element related to the environment surrounding PEO, Missiles and Space is the benefits associated with being a government employee and how effective these benefits are in attracting potential employees. Because a significant portion of the arguments made in the Perfect Storm relate to the aging workforce, it is important to evaluate how easily these positions can be filled as retirements occur. One consideration that must be taken into account is the pension plans offered to government employees. In today's social environment, more people are working longer because of the increased life expectancy and the need to meet the associated costs with living longer. Very few commercial organizations offer retirement plans as enticing as those offered to government employees. As healthcare costs for the elderly continue to climb, a job opportunity that offers pensions and medical benefits will be more highly sought after.

4. Technological

The last environmental/context component of the inputs affecting PEO, Missiles and Space are the technological factors. It is in this area of the model where the direction research became more focused and the analysis more concentrated. As previously alluded to in the political environmental factors, there is a risk associated with funding more immediate priorities with resources originally intended for research or developmental activities. The President's FY 08 Budget accepted risk in the areas represented by the systems managed under PEO, Missiles and Space. During interviews in the research and data collection process, it became evident to the researchers that the PEO's efforts to characterize the Perfect Storm argument had revealed a closely linked and potentially more serious concern. As it evaluated its workforce and the expertise in the missile-specific engineering fields, the PEO discovered what it labeled, "militarily significant critical technology atrophy." (See Figure 6.) In essence, it identified that not only were the personnel concerns highlighted in the Perfect Storm an issue because of the shortage of required personnel, but more importantly, those personnel being lost represented an unrecoverable skill-set central to current and future missile development.



In its characterization of the external technological environment, PEO, Missiles and Space identifies multiple elements which we have grouped into four major components. The first is the position of the United States missile capabilities in relation to our allies and potential adversaries. During the time of interviews for this project, PEO, Missiles and Space was drafting a presentation to characterize the capability gap and trends in this area. In its draft form, the presentation made the following five claims.

1. Existing capability gaps are not being met.
2. Performance gap closing between existing US and Foreign Systems
3. Targets and threats are evolving and present greater challenges
4. US science and technology no longer leads world in many missile-relevant categories.
5. No new development of “Next Generation” tactical missiles.

Confirming the degree of accuracy of these claims goes beyond the scope of this project; however, accepting the underlying premise that a technological gap is desirable is central to the characterization of the external technological environment. As with the development of all military weapon systems, the environment surrounding missile development is a competitive one. Unless resources are steadily allocated toward advancing critical technologies, the gap between the world leaders and the rest of the world will close in that particular field. This brings us to the second major component of the technological environment: funding of the missile science and technology base.

This is the first step in the development process—in which technologies are investigated and matured to the point where they can be weaponized. Because the process often requires several paths to be followed until a useable capability is developed, this is a resource-intensive first step. Both funding and the commitment of technological leaders by the government and industry are required for this phase to be successful. For this reason, it is more difficult to maintain a technological gap



than it is to close one. In the past, the US has been willing to fund these activities to maintain at least one technological generation ahead of the nearest competitor. Based on recent and estimated future funding levels appropriated to PEO, Missiles and Space, maintaining this gap may no longer be a priority (Assistant Secretary of the Army, 2007). (See Figure 6) This leads directly into the third element of properly creating incentives for industry.

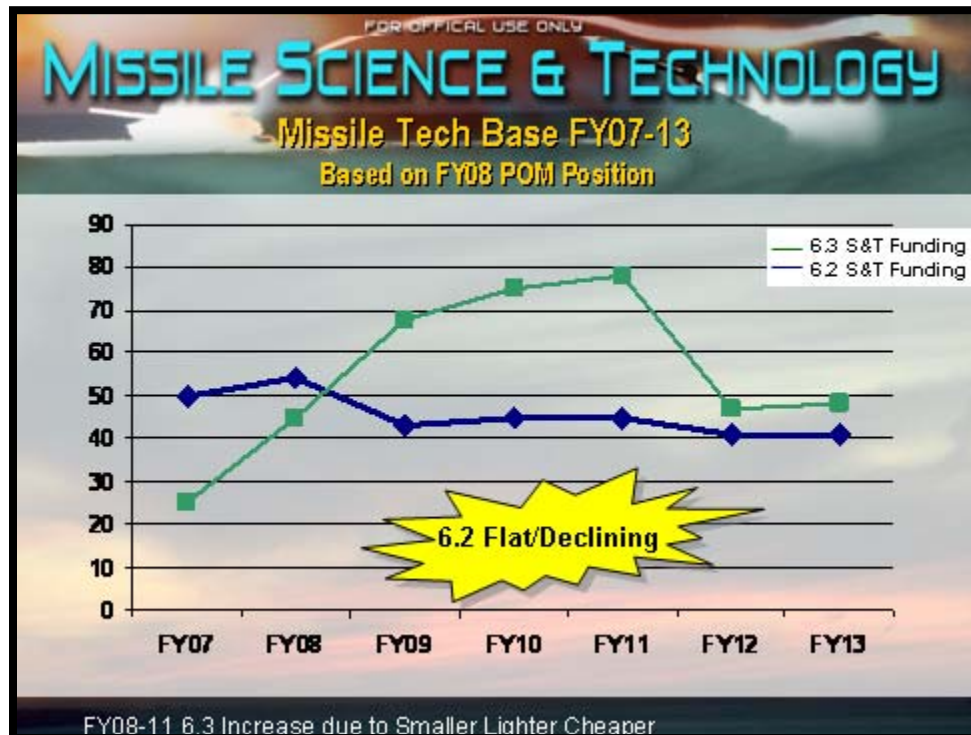

Figure 6. Missile Science & Technology
(Program Executive Office, Missiles and Space, 2007, February)

Industry takes its cues from the developmental priorities set by the DoD through its allocation of resources and the perceived profitability in those areas. When developmental funding for a particular field decreases, this sends the signal that other areas may be more profitable in future years. In response to this signal, industry will reallocate its technical expertise and commit its independent R&D efforts into more profitable developmental projects. Unlike other areas in which a technological gap is advantageous, missile technologies do not have a significant commercial application. When the DoD makes a decision to accept risk in aviation,



communications, or other technological areas, an incentive remains in place for industry to push the technological envelope in hopes of future commercial sales. Because this is not the case with vital missile technologies, industry has no incentive to keep critical personnel in those areas or to invest resources toward developing new technologies or sustaining systems already developed and fielded. As a result, industry has already begun to reassign personnel out of missile critical technologies. A recent study conducted by PEO, Missiles and Space found a decrease in 32-63% of personnel in these fields by its largest industrial partner. Further research is underway to compare these results and verify the trend with other members of industry in the missile development field. Similar results are expected, highlighting what the PEO is calling an unrecoverable erosion of the technological base. It is this technological base which represents the final element of the technological environment.

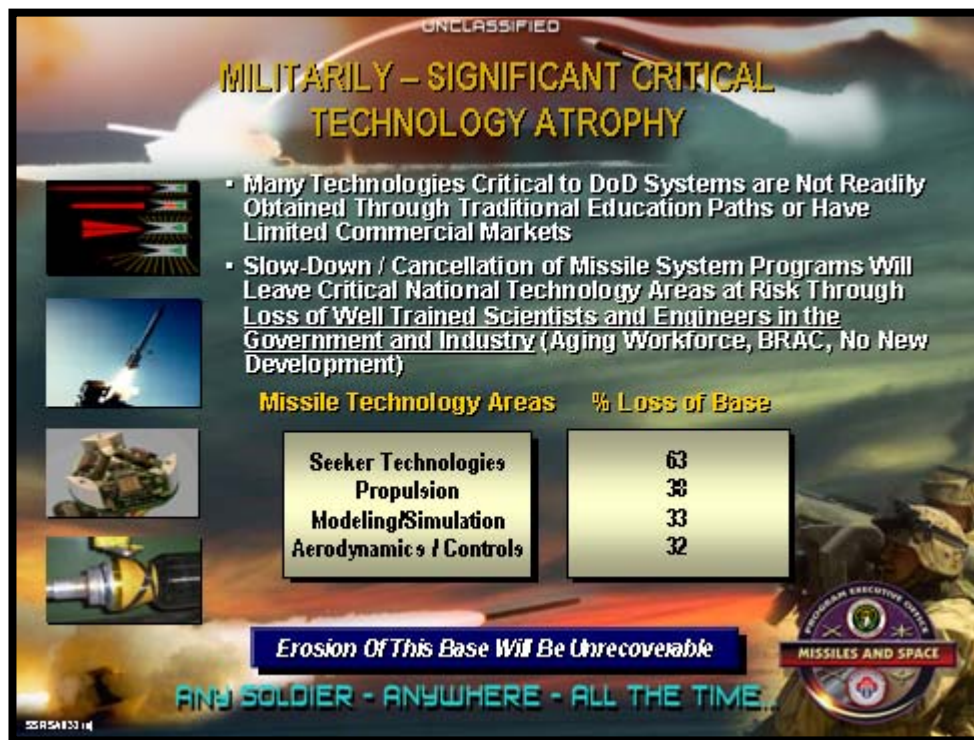

Figure 7. Military Significant Critical Technology Atrophy
(Program Executive Office, Missiles and Space, 2007, February)



It is clear that the DoD has accepted risk by reducing funding for developmental efforts. What is not clear is exactly the level of risk it has accepted or whether or not it has been accurately characterized. If the strength and depth of the technological base (along with the capability gap between the US and its competitors) have been effectively characterized, then the accepted risk can be mitigated by increased resourcing—should a threat quickly emerge. If, however, these estimates have overestimated the technology base and/or the current capabilities gap, then increased resourcing will not be able to mitigate emerging threats. It is at this point in evaluating the technological risk that the personnel argument made in the Perfect Storm reemerges. After a prolonged period of no new development in a technical field, the subject matter expertise is lost. When this occurs, no matter how many new resources are applied, a relearning of the field must take place before advances can be made. Many of the current engineers in the missile field are in the latter stages of their careers. This component of the issue will be expanded upon in the design factors of the organizational systems model. With no significant future in missile technologies visible to industry, the next generation of missile developers is not seen as a worthwhile investment.

C. ANALYSIS: ENVIRONMENT/CONTEXT

Based on these findings, the external environment/context surrounding PEO, Missiles and Space could best be described as challenging. The combination of political, economic, social, and technological factors comprising the external environment to the organization will require positive adjustments in other areas if the same desired results are expected to be achieved as outputs of the PEO. Because the organizational model that defines the PEO continuously changes as throughput and results provide feedback, it is important to evaluate the environment in terms of trends. Politically, the most significant trend is the waning support for the war in Iraq. As this trend continues, the political trend of providing the warfighter with what he needs to successfully execute the GWOT will gradually become less of a priority. As political support focuses on other national priorities, fewer resources will be made



available for defense spending. Although this general trend has been consistently downward for years, the trend may intensify as a result of political factors. This will further aggravate the adverse environment already facing PEO, Missiles and Space. The significant trends in this area have been to prioritize funding of systems being utilized in the current operational environment at the expense of those geared toward other national threats, and to accept risk and delay or eliminate next-generation systems for more immediate funding needs. In both of these cases, PEO, Missiles and Space is not in a favorable position based on the weapon systems they manage. The combination of these trends in turn signals to the industrial base that sectors other-than-missile-related technologies may be more profitable. The mid-to-long-term effects of this trend can have a significant adverse effect on PEO, Missiles and Space. The current organization could become dysfunctional, and a more optimal system capable of surviving in the current external environment may need to arise.

D. FINDINGS: KEY SUCCESS FACTORS

The second input of the organizational systems model is the key success factors. The primary research efforts in this area were to determine whether or not the PEO identified the correct factors, whether recent results of the system confirmed this, and finally whether or not the PEO saw the need to reevaluate its measures of success. The four key success factors identified by the PEO are: 1) Perform as the Army's centralized manager for assigned programs, 2) As the responsible management official, provide overall direction and guidance for the development, acquisition, testing, production, product improvement, fielding and sustainment of assigned programs, 3) Place primary management emphasis and oversight on total life-cycle cost, schedule and performance while ensuring compliance with applicable national policies such as environmental protection and socioeconomic programs, and 4) Maintain a total Army perspective in managing assigned programs, and keep the senior Army leadership fully apprised of program status—to include problems which could affect the Army's ultimate commitment to



the program (Program Executive Office, Missiles and Space, 2007a, p. iv). Through interviews with members of the PEO, it became clear to the researchers that the Perfect Storm and its surrounding issues centered on one particular key success factor; although the first three success factors have relevance to the research, the fourth is where attention needed to be focused. This success factor concerns the voicing of the Perfect Storm issues and the related development and packaging of the industrial base concerns. In addition to these stated success factors or responsibilities, the PEO (like all other organizations) is concerned about its survival and the well-being of its employees. These unwritten measures of success must also be considered when evaluating its strategic decision-making process.

Based on the PEO's recently generated results that relate to the first three key success factors, we can determine that the organization performed well; those factors were most likely correctly determined. When evaluating the results that serve as a metric for performance as it relates to the fourth key success factor, a less conclusive answer is arrived at. The challenge in this area is in interpreting the boundary of the system and how PEO, Missiles and Space relates to the larger Army system. The fourth factor implies that keeping the Army leadership fully informed is beneficial to the PEO, Missiles and Space system, or that the survival of the PEO is secondary to the objectives of the Army. In either interpretation, the systems model boundaries would determine whether or not this was a key success factor. For the purposes of our analysis, the assumption that PEO, Missiles and Space would have survival and retention of personnel as a key success factor was made. In determining whether or not the PEO Staff saw the need to reevaluate their measures of success, it is clear they are at least assessing their performance and appear willing to change if necessary. Again, there are no significant findings in this area.

E. ANALYSIS: KEY SUCCESS FACTORS

Given the findings concerning the environment/context and the trends in those areas, success for the PEO may need to be redefined. Ultimately, the



success of its system may hinge on how well it executes its fourth key success factor and how the Army leadership responds to its issues. Overall, this component has a positive impact on the PEO, but does not have a significant impact on the organization's systems operations—at least in terms of the issues central to the Perfect Storm and related issues.

F. FINDINGS: SYSTEM DIRECTION

The final component of the input section of the organizational systems model is the system direction. For PEO, Missiles and Space, setting this system direction in the wake of *PBD 753* has been a priority. Its focus in this area has been to identify the impact of this shock to the organization and to determine a course of action to stabilize the system. Findings in this area can be broken down into the seven subcomponents identified in the Organizational Systems Framework model.

1. Mandate

The first subcomponent is mandate. As in the case of most military organizations, findings in this area are fairly clear. PEO, Missiles and Space has a formal mandate to manage its assigned systems to specified cost, schedule and performance measures. Additionally, it is required to comply with higher-echelon directives such as *PBD 753* and congressionally directed regulations and procedures. The only significant finding in this area is that due to these mandates, some potential courses of actions to issues identified in the Perfect Storm may not be feasible.

2. Values

The values of the organization and its impact on the overall operation of the system can be significant. In the case of PEO, Missiles and Space and the issues surrounding the Perfect Storm, most of the relevant findings in this area center on the recent merger and the effects of *PBD 753* on support contractors. In January 2005, PEO Tactical Missiles and PEO Air Space and Missile Defense merged to form PEO, Missiles and Space. This merger took place only one month after the



issuing of *PBD 753*—which targeted “support contractors” as the primary area in which directed efficiencies should be made. As will be discussed in the analysis of the design factors, every effort was made to gain the efficiencies through natural attrition and retirements. Whether beneficial or detrimental to the organization, this personnel-first approach sent a message to the organizational employees that they were important. Although personnel may have been retained simply because they were essential to the operation of the system and future personnel cuts to meet the remaining efficiency may be necessary, this initial round tells us something about the values of the organization. This point, however, has limited influence in terms of the direction of the system. Had there been many personnel cuts and increased workloads for the remaining employees, this would have signaled a change in direction.

3. Mission

The mission is a powerful component of the direction of the system. In the case of PEO, Missiles and Space, its mission was not changed with the mandate of *PBD 753* and remains as outlined in Chapter Two. The recent presidential budget decisions that have resulted in the termination or delay of systems development have only reduced the scope of their mission and perhaps made it a more difficult mission to accomplish. The primary findings in this area are related to what changes to their mission may be necessary if current trends continue. In its *Declining Missile Base* presentation, PEO, Missiles and Space identifies that as a result of recent budget decisions, no programs under its management are due to transition from the tech base from FY08-13 (2007, February). (Figure 8.).





Figure 8. The Eroding Business Base
 (Program Executive Office, Missiles and Space, 2007, February)

If for six years there is no planned execution of this component of its mission, the question arises of whether to retain the personnel, training, and resources focused on this element, or to simply eliminate this part of the mission. If the six-year period is only a pause in future missile development, then changing the mission would not be wise. Although continued resources will be inefficiently spent to maintain a capability not being utilized, it will be more cost-effective than losing the skill set and being forced to redevelop it within the organization. If, however, these periods indicate the beginning of the end to missiles as warfighting systems, then the mission should be changed and continue to change as the systems the PEO manages are slowly phased out of the inventory. This decision will hinge on the resolution of the Perfect Storm and related issues outlined in the next component of the system direction.



4. Strategic Issues

Bogosian & Cannon's White Paper is the characterization of some of the strategic issues facing PEO, Missiles and Space that may effect the direction of the system. The primary and secondary research questions identified in Chapter One identify how the direction may be intentionally or unintentionally changed based on the resolution of these issues. Our findings have revealed additional strategic issues that are also significant to the PEO. The most significant issue presented to us during research and interviews with the PEO staff was the classification of missile technology as an asset of national security and as a resource that must be protected. This argument is closely related to the Perfect Storm personnel issues and was summarized earlier in this chapter under the technological environment section. Essentially, the strategic issue being faced is that current trends indicate no future missile development for any of the four battlefield operating systems supported by the PEO. BG Cannon indicated he did not know whether or not the Army staff recognized they eliminated all missile development, or if they evaluated each of the decisions independently and failed to realize the sum effect of their decisions. The resolution of these strategic issues could have a range of impacts on the direction of the system. The system could continue to proceed along its present direction or take a turn that leads to the collapse of PEO, Missiles and Space.

5. Vision

A vision can clarify an organization's direction and purpose by illustrating a future state and identifying the path to get there. Our findings in this area indicate that PEO, Missiles and Space is anticipating successful resolution of the strategic issues it is presently facing. This position is based on the future state expressed in the PEO's vision—which has missiles and missile-related technology playing a key role in the Army's warfighting strategy. The vision identifies a path that mitigates the impact of the four primary elements contributing to the Perfect Storm and related issues. This path will be further defined in subsequent paragraphs that outline the strategy and address the design factors of the organizational systems model.



6. Goals

The goals PEO, Missiles and Space have established were listed in Chapter Two. In Chapter One, we stated our research in this area would need to determine what, if any, goals were established by the organization that directly related to the Perfect Storm and associated issues. The primary short-term goal of fending off the efficiencies mandated by *PBD 753* was not successful. The Perfect Storm argument stated: “Now is the absolute wrong time for attempting to gain personnel efficiencies at Redstone Arsenal” (Bogosian & Cannon, 2006, April 30). But, the PEO was unsuccessful in its argument. The focus of the PEO then shifted to mitigation options. During our research, we discovered the organization had put in place a Strategic Workforce Transformation Plan (which will be discussed in more detail in the next section of this chapter). The plan identified seven goals focused on mitigating the effects of the four elements of the Perfect Storm. The seven goals are: 1) Develop a Living five-year plan to recruit a diverse, highly motivated and talented workforce, 2) Establish training and development that links to the mission in order to achieve yearly performance goals, 3) Target programmatic areas that will be losing expertise in the short- (3-5 years) and long-term (5+ years), 4) Provide aging workforce the opportunity to share their expertise with new hires, 5) Partner with academic institutions, Government programs and private organizations to maintain an effective workforce, 6) Promote a lifelong learning environment, and 7) Develop a multi-functional culture (Parmer, 2006, September).

Our findings on these goals are that they are well conceived and support the vision, mission, and key success factors previously covered in this chapter. However, we find they were most likely established too late to fully mitigate the impact of the Perfect Storm issues. Due to the academic and on-the-job training required in the more technical positions, mitigation strategies that are just now being employed may not produce the required number of workers until some time after they are needed.



7. Strategies

Changes to the external environment necessitated changes in other areas of the organization in order for the system to remain stable. PEO, Missiles and Space employed two strategies for dealing with the changes with one being internally focused toward the design factors, and another aimed at addressing the outcomes generated by the PEO. The first internally focused strategy is the Strategic Workforce Transformation Plan mentioned previously in the goals. This plan focuses internally on the organization and the design factors which capture the operations and inner working of the PEO. In simple terms, the strategy was to grow the next generation of personnel to replace those identified in the Perfect Storm argument who would be retiring, taking positions in BRAC organizations, eliminated due to *PBD 753*, or returned to their parent matrix organization. The strategy identifies critical positions or fields within the PEO that must be intensely managed. These positions are primarily the more technical positions in which the greatest risk has been identified.

Utilizing partnerships with academic organizations, internships, and expanded recruiting efforts to attract qualified personnel is the next phase of the strategic plan. During our site visit, we discovered a relationship with the University of Alabama in Huntsville (UAH) had been in place for more than fifteen years. This program, Students Working at the Army in Parallel (SWAP), is evidence that at least some of the personnel issues PEO, Missiles and Space is facing today were experienced and addressed at some point in the past. Further evidence of this is the unique and specialized Missile Systems Engineering degree that UAH offers. The strategic plan hinges on attracting personnel and then providing them with incentives to remain with the organization. When the staff was questioned as to whether or not they had sufficient incentives to compete with industry, a clear answer could not be given, but there were mechanisms identified that would enable the government to be competitive. As we further questioned how the strategy may be providing education and training for individuals who would then leave to work for the higher salaries offered by the defense manufacturers, we again saw the intersection of the Perfect



Storm argument with the eroding missile technology base issue. As previously mentioned, industry will focus its efforts where it sees the most potential return on investment. If in the future the missile development business again appears profitable, industry will need experts in the field to spearhead its efforts. If its internal experts have been moved to other projects as the figures presented earlier in this chapter indicate, then it will look external to the organization to fill these positions. Given the potential financial gains, industry most likely can offer an incentive package that the government can not match. This apparent shortcoming in the internally focused strategy of the PEO is exactly what the second prong of their strategy addresses.

As we described in Chapter Two and identified at different points in this chapter, the model defining PEO, Missiles and Space's organization is a living model; the results constantly fed back into the throughput and inputs in a continuous process. The second prong of PEO Missile and Space's strategy is to forecast results based on the changes to the inputs. Specifically, the strategy focuses on highlighting the outcomes that other stakeholders may not have correctly identified when making recent budget decisions. The industrial base and missile-critical technologies issues related to the Perfect Storm are the outcomes the PEO, in its strategy, hopes will signal more risk has been accepted than previously thought or understood. This effort utilizes what, in terms of the systems model, are the feedback loops in an effort to change the external environment to one more favorable to PEO, Missiles and Space.

E. ANALYSIS: SYSTEM DIRECTION

Based on the findings in this area of the model, some of the impacts of the Perfect Storm elements can and are being mitigated by a shift in the direction of the organization. The strategies put in place are having a positive effect—which will be discussed later in the findings of the design factors for which they were oriented. The effectiveness of the second prong of the strategy is at addressing the technology base issues related to the Perfect Storm will determine whether or not



changes to the mission of the PEO will need to be made. It is clear that the mission, vision, goals, and strategies are currently based on the DoD continuing to have missile weapon systems in its strategic vision. If this is not the case, then significant adjustments will need to be made; the organization will have to endure a drastic reorganization to be more efficiently tailored to produce the desired outputs.

F. CHAPTER SUMMARY

Research revealed the environment/context external to PEO, Missiles and Space is not a favorable one, and is in fact quite challenging. Short-term funding issues may be leading to long-term technological problems. The key success factors have, based on our findings, accurately taken into account this adverse environment and provided a focus for the organization. The system direction has, in turn, been oriented toward those key success factors; likewise, the mission, vision, and goals are aligned with the strategy for this shift. Based on the changes to the inputs of the system, either the PEO must become more efficient or the expectation of outputs must be reduced for the system to remain in balance.



IV. FINDINGS AND ANALYSIS SYSTEM THROUGHPUTS

A. OVERVIEW

This chapter presents the findings and analysis relevant to the throughput section of the organizational systems model, e.g., design factors. The same format utilized in presenting the data for the input section in Chapter Three is followed. Findings relative to the five elements of the design factors is presented and an analysis of those findings is conducted. The focus of these findings and analysis is to provide an understanding of how PEO, Missiles and Space operates, how the inputs previously discussed affect operations, and how changes to operations affect the results of the system. Design Factors of Structure, Tasks/Jobs, People, Technology, and Processes are addressed from the perspective of the Perfect Storm and related issues. Focus is on the primary elements of these areas that are relative to the issues being discussed, and how they interact to produce the results of the system.

B. DESIGN FACTORS

As stated in Chapter Two, this section of the model represents the area under the most direct control of PEO, Missiles and Space. The premise of the Perfect Storm was that directed changes to the external environment of the system (*PBD 753*) without changes to the desired results could not be achieved simply by making internal adjustments to the design factors that define how the organization operates. Our research efforts in this area focused on determining whether or not this was an accurate representation of the situation and whether or not the position taken by the PEO was valid.

1. Findings: Structure

In order to understand how the five design factors interact, it is necessary to start by describing the findings related to the structure of the organization. PEO,



Missiles and Space is a complex organization with a wide range of responsibilities. The PEO is comprised of seven Project Offices which each manage their assigned systems. Although the size and structure of each Project Office varies based on the systems its supports, each office has similar capabilities with common characteristics. The personnel that work in the PEO come from four primary sources: core, matrix, military and contractor support. The core forms the base of the organization and accounts for the majority of the leadership and approximately 32 % of the total workforce. This group is responsible for the programmatic functions related to the assigned weapon systems and the overall acquisition strategy. The matrix personnel are the technical experts that provide inputs to the core members enabling them to make informed decisions. PEO, Missiles and Space receives support from six different matrix organizations that each provides a specific technical skill. All matrix organizations have a pool of personnel from which they assign technical support to acquisition organizations at Redstone Arsenal as their expertise is needed. They are designed as a flexible workforce to be utilized for a specific task and then returned to their matrix pool for assignment to another project. Matrix support personnel make up approximately 40% of the workforce within PEO, Missiles and Space. The third source of personnel is the military. The assigned military make up the smallest component of the workforce at only 4%. Their primary role is to provide leadership and guidance to the organization and to serve as the key liaisons between the developers and the user community. They are assigned on a rotational basis and typically have tours of 2-3 years. The final source of personnel is from commercial contractor support. These are the Systems Engineering and Technical Assistance (SETA) personnel who provide a specific technical expertise that is not available through the matrix pools. When a specific skill is required to provide oversight of a technical aspect during system development, a SETA employee may be brought on to the government team because this skill set is highly unique and not in frequent enough demand to be part of the core or matrix organizations. Where the core, matrix and military personnel levels are set by authorization documents, the SETA personnel are assigned and



constrained by budget. Personnel in this category presently account for 24% of the workforce within PEO, Missiles and Space.

When discussing the structure of the PEO and the Project Offices, it is important to include the members of industry with which the government works. Although technically not part of the organization, they are an integral component of the structure that must be worked with hand-in-hand to successfully develop, produce, and maintain warfighting systems. Through the use of Integrated Product Teams (IPT), the government and its contracted material developers have become more of a joint structure. When analyzing PEO, Missiles and Space through the organizational systems model these IPTs must be considered part of the structure in order to effectively capture how the system operates.

Within the structure of the design factors there are three main areas on which we concentrated our findings. The *PBD 753*, matrix support, and the industrial base each have significant relevance to the Perfect Storm and related issues. The first of these areas to be addressed is *PBD 753*. This decision affected the structure of the organization by targeting SETA employees within government organizations. Although not clearly stated in the decision, it is evident the *PBD* was based on the assumption that subordinate organizations were operating with excess personnel. By requiring the mandated efficiencies to be arrived at through the elimination of SETA and not simultaneously reducing the required outputs of the organizations, this inference can be made. The question our research needed to answer, then, was whether or not the assumption was valid. If the assumption was correct, then the outputs of the system could remain the same. If, however, the assumption was incorrect, then changes to the outputs would be necessary to keep the system in balance. Our finding on this issue revealed the assumption at the time of this research was for the most part valid. There are, however, three caveats to this finding.

1. All of the required positions have not yet been eliminated.



2. Of the positions eliminated to date, most would have been eliminated independently of the PBD.
3. In addition to the personnel positions, minor cuts to the GMLRS program were also required to meet required efficiencies.

At the time of our site visit, 154 positions had been eliminated in order to reach the targeted cost efficiencies required by *PBD 753* (Human Resource Manager, 2007). A plan has been implemented to meet the remaining required personnel cuts, but the plan does not reach the full 300 positions estimated in the Perfect Storm. During our interviews, it became evident that the final cuts would be difficult and could prove the assumption false. Unlike the initial cuts, the positions to be identified for elimination most likely would not yet have been. As previously mentioned, PEO, Missiles and Space was born out of the merger of two separate PEOs in January 2005. Most of the cuts made to date would have been eliminated as part of the efficiencies associated with the creation of the new organization. Now that these positions have been eliminated, the PEO will need to address other elements of the design factors to meet its required outputs. The impact of *PBD 753* on the PEO has been negative because it did require the elimination of positions, but the net result to the system has been neutral based on its continued ability to meet required outputs. At this point in time, the cuts appear to have only eliminated the unnecessary excess portion of the organization. The effects of further cuts may prove to be negative not only to the design factors, but to the overall organizational system as well.

The second area of matrix support was also one of the four major initiatives that comprised the Perfect Storm. The argument made by PEO, Missiles and Space is that the matrix support base has been so poorly managed over the past decade that it is no longer capable of providing the quantity or quality of technical experts necessary to support its customers. Our findings on this topic were mixed. The matrix support base has not been managed as well as it could have been, but the cost of this mismanagement and the risk it represents are difficult to quantify. Because the PEOs had the ability to hire SETA to augment their matrix personnel



when necessary, or provide a skill set that the matrix had not developed in its pool, any problems with the matrix have been masked.

During our site visit, we asked the technical personnel on the PEO staff whether they were pleased with the quality of the matrix personnel they were receiving from the pools. We also posed this same question to technical members of the Project Offices. In both cases, they indicated that they were pleased with the personnel, but also did have some concerns. The primary concerns were that the expertise had become somewhat stove-piped—one of the arguments alluded to in the Perfect Storm. Although training and education may be able to effectively provide the matrix pools with qualified individuals, the issue facing the PEO is that much of the institutional knowledge and histories of the decisions surrounding weapon systems can not be easily transferred. In an ideal situation, a new employee would have a lengthy transition period with the matrix personnel holding the institutional knowledge. This, however, is not a cost-effective method for doing business—at least in the short-term. Because of the inability to hire the government employees back as SETA support as was the practice prior to *PBD 753*, the transition period is not likely to occur—resulting in the loss of the institutional knowledge. Based on these findings, the assessment of the matrix support system on the PEO is negative. Although the majority of the adverse effects are yet to be realized, it is clear based on the current path that they will be.

The final area to be addressed regarding the design factor of structure is the industrial base. The industrial base itself lies outside of the organization in the external environment discussed in Chapter Three. Why this is being addressed in the structure of the organization is because of the shared pool of technical experts from which both industry and PEO, Missiles and Space draw. The boundary between the external environment and the organization relative to this issue is somewhat permeable and free flowing. Because of this relationship, it is important to include these limited personnel resources as a component of the structure. In the planning of this research, this area was not originally considered as a significant



element relative to the Perfect Storm, but as initial findings were made it became evident that the personnel aspect of the industrial base was in fact an area that must be considered. The majority of the significant findings in this area were addressed when discussing the technological elements of the external environment earlier in this chapter. The specific findings that relate to the structure of the organization are those that address the shared pool of technological experts. Over the past 15 to 20 years, two significant factors have had a significant impact on the missile industrial base and the personnel that work in these highly technical fields. The first is the Army has downsized from over 730,000 in 1990 to just over 512,000 in today's force (Department of Defense Statistical Analysis Information Division). A smaller force means less warfighting systems, which in turn results in less demand for missile systems and less required technical expertise from the shared pool to work in both government and industry roles. The second factor is the consolidation of defense-oriented business through mergers over that same time period that further reduced the demand on the shared personnel pool. As a result of those two factors, the industrial base and the common pool of personnel to the structure of the organization have shrunk dramatically. What is left is now in terms of the technical expertise in the missile development field is consolidated under a few major contractors and the government. In industry, the leader is Lockheed Martin who now provides an estimated 80-85% of the missile-related acquisitions PEO, Missiles and Space engages in (Business Manager, 2007). These findings illustrate a very dependent relationship between the government and limited producers of missile technologies. The trends which indicate industry is moving its personnel from the common personnel pool out of the missile-related fields and into more profitable areas demonstrate how the structure for PEO, Missiles and Space can be weakened. Essentially, it does not matter how many resources are provided as inputs to the system if the structure is not capable of producing the desired outputs.



2. Analysis: Structure

Our findings in this area indicate that PEO, Missiles and Space is structurally capable of producing the short-term outputs the organization is designed to generate. The mid-to-longer-term effects of *PBD 753*, the matrix personnel pool, and the shrinking industrial base will likely impact the structure of the organization in a way that will substantially challenge the organizations' ability to produce mid- and longer-term desired outputs (five years out).

3. Findings: People

People are the central strategic issue of Bogosian & Cannon's White Paper. Each of the four initiatives has an identified adverse effect on the personnel working for PEO, Missiles and Space. On the surface, it is relatively clear that all four initiatives will have the suggested negative effect on the organization. Yet, the focus of research in this area was to go beyond how the initiatives would in general affect the workforce, and to determine what specific groups of people were going to be affected. By doing this, the researchers could assess the impact on the design factors of the organizational systems model and determine the effect on the overall model. The findings in this area were grouped into three areas consisting of technical, retirement, and BRAC.

Because of the wide range of tasks performed by the organization, PEO, Missiles and Space is comprised of people with various skill sets. Many of these positions require a very skilled and educated person, while others require less technical skills and formal education. Although the Perfect Storm and related issues address all of the positions in the PEO, it is the highly technical positions where the greatest risk has been identified. The combination of the four initiatives will impact all positions; however, mitigation strategies are much easier to develop for lesser skilled positions because of two factors. The first is there is a larger pool of qualified personnel to perform those tasks. The more training and specific education requirements required for a position, the lower the number of qualified potential applicants. During our site visit, we interviewed personnel in the human resources



department of PEO, Missiles and Space. They identified positions to us that were difficult to fill. One example provided was an Operations Research Analyst. In one particular case, a job opening was advertised and only attracted 3 applicants for a position paying between \$74,000 and \$97,000 annually (Human Resource Manager, 2007). All three of those that applied were offered jobs. The second factor limiting mitigation strategies is the timeframe required to properly educate and train an employee for a position. One of the senior technical analysts of PEO, Missiles and Space provided us with a timeline of seven to nine years for a person to complete basic eligibility requirements, and 11-12 years before they will have enough practical application and job experience to be useful in a technical role (Senior Leader, 2007). Estimating what the optimal size of the workforce will be a decade out is difficult, and the timeframe greatly limits mitigation options. Based on these findings, the technical personnel issues within the organization are the ones that present the greatest risk to PEO, Missiles and Space. If efforts to attract, train and retain are not effective the organizational system will not function efficiently.

Like the rest of the workforce in the country, a large percentage of PEO, Missiles and Space's employees at or approaching retirement age. As of 24 September 2006, 52% of the workforce was 50 years or older (Parmer, 2006, September). Although this trend applies to all skill level positions, based on the findings in the previous section, the people we are most interested in are the retirement-age personnel in the highly technical positions. The PEO is closely monitoring the average age of its employees, their years of experience, and their eligibility for retirement. These figures are grouped based on the personnel source and skill level of the individual making the statistics very useful in determining trends and identifying risk. In addition to these statistics, the PEO is also tracking trends in the replacements for those retiring. Since January 2006, 50 personnel have been lost—with the group having an average age of 56, and 25 years of experience. Their replacements, on the other hand, have been 10 years younger and on average have 16 years of experience. Our findings regarding retirement as it relates to the people of the organizational system are that the PEO is doing an exceptional job of



monitoring the trends, but can do little to manage the retirements. On one hand, the average age of the workforce getting younger is a positive trend, but it is normally accompanied with the same trend in years of experience which may be the more significant metric.

The third major issue related to the people of the organization is the impact of BRAC on PEO, Missiles and Space. Similar to how aspects of the external environment needed to be addressed when analyzing the structure of the PEO, components of the BRAC must be considered when analyzing the issues surrounding the people of the PEO. Although BRAC is an external political factor now, after the organizations arrive and begin drawing from the same government, matrix, and SETA personnel pools, they will become part of the organization. For this reason, we must address relevant issues of that future time period when discussing the internal design factors. For Huntsville and Redstone Arsenal, this latest set of realignments and closures will result in the net gain of an estimated 9,700 jobs over the next few years. Based on the type of organizations being moved into the area, similar skill sets to those required within PEO, Missiles and Space will be needed. During interviews with the PEO staff, it became evident the staff did not believe it could compete in terms of pay grades with some of the organizations coming to the area. Specifically, the Missile Defense Agency (MDA) had the ability to offer more competitive salaries—increasing the incentive for current Missiles and Space employees to leave the organization. Although people are also motivated by factors which would make them less likely to leave PEO, Missiles and Space such as job satisfaction, loyalty, and the fear of the unknown, monetary reasons will lure some percentage of employees away. Additionally, these new organizations will be drawing from the same matrix pools as the PEO. Therefore, any problems with the matrix will be exacerbated. One finding relative to these issues is there appears to be no central management of personnel regarding the BRAC. Although planning committees exist, these seem to be more facility oriented and not focused on potential personnel issues. Another finding made in this area is the number of technical job openings for Redstone Arsenal—including those related to the BRAC



organization that are already being advertised. During our site visit, we did a job search for Huntsville, Alabama. On 30 January 2007 there were 46 openings on the official USA Jobs website. Of the 46 positions, 35 were for engineers and another 2 were for physicists (Office of Personnel Management, 2007). In monitoring the website since that date, the technical positions being advertised have continued to grow. This indicates that the people holding those technical skills may not feel the need to conform to the organizational norms and standards due to their high demand and recognition of their value to the organization.

4. Analysis: People

Based on the findings relative to the technical, retirement, and BRAC elements discussed, the skill sets of the people of the organization, their experience and needs must be aligned with organizational design factors. The impact of having the required skilled people in an organization such as PEO, Missiles and Space is paramount. The timeline required for replacing lost personnel will be compounded as the competition for personnel grows. The PEO has put in place the proper mechanisms to track the people and the trends that motivate them. Additionally, it has an aggressive strategy for addressing the personnel losses expected as a result of the Perfect Storm and related issues. Overall the people of the organization are currently having a neutral effect on the productivity of the PEO. As more BRAC organizations arrive and more personnel retire the effectiveness of the mitigation strategy will determine whether or not the organizational system is adversely affected.

5. Findings: Tasks/Jobs

In Chapter Two, the mission of PEO, Missiles and Space was defined and the responsibilities they were charged with were described. The tasks and jobs associated with meeting these responsibilities is the focus of this section. Our research in this area focused on determining what tasks were most directly impacted by the changes to the external environment discussed in Chapter Three.

Additionally, the potential mitigation strategies the PEO considered for these tasks



needed to be evaluated. As we have discussed throughout the findings regarding the design factors of the model, the technical personnel, tasks and structural organization are the key components at risk according to the Perfect Storm. In the case of tasks, the risk that will be realized first is the inability to provide effective oversight of the contractors developing and producing the missile systems. In an environment with performance-based contracting, it is important to have the subject-matter expertise capable of evaluating the technical approaches being taken. As the technical personnel pool shrinks due to the factors previously discussed, there will not be sufficient personnel to accomplish these key tasks. If this occurs, the programmatic elements will be out of control, and PEO, Missiles and Space will become much more inefficient.

6. Analysis: Tasks/Jobs

The changes to the external environment have done little to change the tasks/jobs the PEO performs. What they have done is put in place conditions that could ultimately result in the inability to perform them due to the lack of qualified personnel available. At this point in time, the PEO has not been significantly impacted. In evaluating the mid-to-longer-term environment, the greater the loss of oversight over time on the developers, the greater the negative impact on the organization.

7. Findings: Technology

The technology component of the design factors refers to the processes and equipment used to make the organization more efficient and not to the technology associated with the products or outputs. The focus of research in this area was to determine how PEO, Missiles and Space could offset potential personnel losses through the implementation of technology. There were two primary findings that related to this area. The first is that organizations, including PEO, Missiles and Space, normally are looking to insert technologies all of the time and not just when changes to the external environment necessitate their implementation. Because of this, the PEO did not have many options available to it that had not already been



implemented. The uses of video teleconferencing, advanced programmatic software, and multiple automated processes have already been implemented in order to gain additional efficiencies. The second finding related to technology is that it is expensive in the short-run. The insertion of technology can greatly advance the efficiency of a system, but it comes at a price. If the PEO were to find a new technology that would enable it to achieve the same outputs with fewer personnel, it most likely would not be able to afford it. The recent budgetary decisions have all sold the future in order to pay for today—meaning; it is unlikely that a capital investment that does not payoff for a few years could be implemented.

8. Analysis: Technology

Overall, the changes to the external environment have had no effect on the technology design factor, and it is unlikely that it will. PEO, Missiles and Space can become more efficient by increasing the use of existing technologies, but it is unlikely additional technologies can be inserted at this time.

9. Findings: Process/Subsystems

The final design factor to be discussed is the process/subsystems. This refers to the systems in place to manage budget, personnel, communications and all networks that link the design factors. Although all of these areas are important, the focus of our efforts was on the human resources management processes. This component would obviously be critical to the efficient operation of a system that was being challenged in terms of personnel. Our research efforts in this area were focused on the internal process the PEO had in place to address how the organization would deal with the changes to the external environment causing personnel issues. As mentioned in the strategy portion of the system direction in Chapter Three, PEO, Missiles and Space put in place a strategy to address the people of the organization. Recognizing there are critical positions and personnel that must be closely managed given the impact of the initiatives addressed in the Perfect Storm, the PEO has put in place a robust mitigation strategy. Central to its recruiting efforts is the partnering with local universities. Additionally, the PEO is



conducting road shows at local schools to make the students aware of the programs offered by the government and the universities with whom they have partnered. The PEO has also addressed the issue with the matrix pools where knowledge became stove-piped. In order to prevent this from occurring, a rotation plan has been put in place for personnel of specific pay grades and backgrounds. This rotation plan will also provide the future leaders of the organization with a diverse background that better prepares them for those leadership roles. Retaining personnel may be the most difficult element addressed in its strategic plan. As previously mentioned, when discussing the impact of BRAC, the PEO does not have the ability to offer the financial incentives necessary to compete with other organizations. The efforts are, therefore, oriented toward creating a good work environment that builds loyalty to the organization. Our findings are that the PEO has put in place a solid plan, but how effective it is in recruiting, training, and retaining people of the organization will not be known for a few years. Overall, this aspect can only have a positive effect on the organizational system.

10. Analysis: Process/Subsystems

PEO, Missiles and Space clearly understands the importance of managing its personnel and has put an emphasis on recruiting, training, and retaining the personnel qualified for the difficult to fill technical positions. The impact on the PEO is a positive one; however, these efforts will most likely struggle to breakeven given the anticipated losses of personnel.

C. CHAPTER SUMMARY

Earlier in this chapter, we described the external environment as a challenging and particularly difficult one for PEO, Missiles and Space to operate in as a result of some recent changes and shocks to the system. Additionally, we found that through the correct identification of key success factors and effective setting of the systems direction, some of the adverse effects could be mitigated, improving system fit. For this to occur, the throughput variables of the model would



have to operate more efficiently than in the past to offset the changes to the inputs. Based on our findings relative to the design factors of the model, this is most likely achievable in the short-term, but is unlikely in the mid-to-longer-term. Many of the changes to the external environment have yet to have an impact on the PEO. It will not be until feedback from the results section of the organizational systems model are processed after a period of time that the full impact of the changes will be known. If the structure of the organization withstands a shrinking pool of technical expertise, and the effects of BRAC, retirements, and the matrix system do not result in the loss of institutional knowledge, then the system will continue to produce the required outputs in an efficient manner. This will also mean that the mitigation strategy put in place by the PEO has effectively addressed the issues the strategy was designed to resolve. The measure of whether or not the organization is producing the desired outputs will be covered next in the results section of the organizational systems model.



V. FINDINGS AND ANALYSIS SYSTEM OUTPUT

This chapter presents the findings and analysis relevant to the results section of the organizational systems model. The same format utilized in presenting the data for the input and throughput sections in Chapters Three and Four is followed. Findings relative to the culture, outputs, and outcomes is presented and an analysis of those findings is then conducted. The focus of research in this area is to analyze short term results produced since the changes to the external environment, and the implementation of mitigation strategies in the design factors, and to forecast results in mid- to longer-term periods based on current trends. Following the analysis of this final section in the organizational systems framework model, the complex interactions of variables surrounding PEO, Missiles and Space should be better understood.

A. CULTURE

This section analyzes how PEO, Missiles and Space has processed recent changes to the external environment and how the realignment of design factors has affected the culture of the organization. After identifying these cultural changes, analysis determines whether or not they facilitate the organizations efforts to accomplish assigned tasks or are an impediment to accomplishing their mission.

1. Findings: Culture

There are two findings concerning the culture of PEO, Missiles and Space that relate to the strategic issues being analyzed. The first is the results of the changing labor mix driven by *PBD 753*. In Chapter 4, we addressed the government, matrix, and SETA personnel pools and their roles in the structure of the organization. In an organization of approximately 1450 personnel, the elimination of 154 positions has resulted in a 10% change in structure and a dramatic shift in the PEO's composition. With the positions lost primarily being SETA, and the remaining cuts necessitated by *PBD 753* also expected to come from this personnel pool, a



change in culture is taking place. Interviews with members of the PEO's human resource department revealed a growing trend of current SETA employees aggressively seeking government positions. This is understandable given the elimination of many of these positions is planned. As part of its strategy for retaining expertise and demonstrating loyalty to its personnel, the PEO has assisted SETA employees with the structuring of their resumes for government positions. Additionally, it has adjusted its personnel authorization document when possible to convert positions to a government core or matrix slating. This affects the culture of the organization in the three ways described below.

First, SETA employees are pressured to demonstrate their irreplaceable value to the organization to ensure job security. On the positive side, this may result in increased effort and performance by employees attempting to demonstrate their worth. On the negative side, employees may seek to show their value by hoarding knowledge in an effort to make themselves a unique and essential cog in the organization's operations. The second affect is the forming of subcultures within the PEO. As the number of SETA employees decrease as a percentage of the workforce, they will become more and more isolated. Despite PEO team building efforts, the natural division between government and SETA employees will grow. The final way these changes potentially affect the culture is in the loyalty to the organization. If PEO, Missiles and Space is able to demonstrate loyalty to its employees during this time when positions are being eliminated, then it will increase the probability of those employees returning that loyalty. This cultural aspect may be valuable when BRAC positions open and offer employees alternative employment options.

The second finding relative to the cultural element is the anticipated turnover of PEO leadership in the summer of 2007. Over the past two years, PEO, Missiles and Space has undertaken and endured changes that can greatly influence the culture of the organization. After being established through the merger of two organizations with cultures of their own, PEO, Missiles and Space further



reorganized some of the subordinate Project Offices, dealt with the personnel impacts of *PBD 753*, and adjusted to additional changes in the external environment. Through this tumultuous time period, the leadership in the Program Executive Office and many of the Project Offices has remained constant providing a consistent and familiar guiding hand. The norms and values of the organization have been established and formed around these leaders; the subordinates have developed formal and informal channels based on the direction they have set. With the anticipated departure of the PEO BG Cannon and four of his seven Project Managers in the summer of 2007, these channels may or may not prove to be effective with the new leadership. The fragile still-forming culture of the organization will be challenged, and a new direction may be taken. Although not directly related to the strategic issues being addressed, the turnover of leadership and subsequent changes to culture will impact the organization's approach for addressing these issues. This variable and its positive or negative affect on the organization will not be known for some time, but their potential impact must be acknowledged.

2. Analysis: Culture

Our findings in this area are inconclusive. Although two cultural impacts have been identified, quantifying and estimating their impact on the system is difficult to complete. As these anticipated changes to PEO, Missiles and Space culture occur and are reflected back into the system, the effects of their change will be better known.

B. OUTPUTS

1. Findings: Outputs

The output of PEO, Missiles and Space is more than the just the weapon systems it produces. The lifecycle management of those systems, the quality of support provided to the warfighter, and the effectiveness of its teaming with industry are all outputs of the organization that must be measured. As they relate to the strategic issues of focus in this analysis, there are three outputs and associated



findings in those areas with which we are concerned. The PEO is responsible for approximately 58 systems in all possible stages of lifecycle management (Program Executive Office, 2007b). The development and production of those systems is the first area under outputs to be covered. Research in this area focused on directed changes to required outputs based on annual authorizations for the systems the PEO manages. The historic funding levels and quantities of systems produced were taken from data available at the Office of the Director for Army Budget (Assistant Secretary of the Army, 2007). The primary finding in this area is not the systems that have been produced, but the ones that will not be produced. During interviews with the PEO staff, the researchers discovered that in order for the PEO to meet the efficiencies required by *PBD 753*, some of the funding would have to come from allocations previously directed for programs. In this case, the GMLRS product line was identified as the source for these funds (Senior Leader, 2007). This change in the outputs of the system was necessary to offset the changes in political priorities. The cancellation of ATACMS, APKWS, JCM and significant reductions to the MEADS program in the President's Budget submitted February 2007 are further examples of reduced outputs for PEO, Missiles and Space necessitated by changes in priorities. These changes affect both short- and longer-term outputs. The cancelled research and development efforts in the short-term translate to less production and sustainment outputs in the longer-term.

The second area of outputs to be considered is the PEO's support to the warfighter in the form of the reliability and availability of fielded weapon systems. Our findings in this area were mixed. In the short-term, it appears PEO, Missiles and Space has been able to provide the same level and quality of support as before the strategic issues being discussed were identified. No significant short-term issues in providing support to the warfighter were identified during the conduct of our interviews. The effects of recent decisions in the mid-to-longer-term, however, are unclear. During our site visit to PEO, Missiles and Space, several concerns in this area were raised. Stockpile reliability was identified as one of those areas of concern. With no new systems being brought on-line to replace aging systems, the



life of the current systems will need to be extended beyond their originally planned lifecycles. In addition to this extension being a costly undertaking, there are also some challenges which will make it more difficult. Concerns over obsolescence are an issue. By extending the life of these systems, there is a chance that some of the technologies used in their design or in their production process will have become outdated and replaced. In these cases the parts, procedures, or the knowledge necessary to ensure the systems reliability may no longer be available. It is difficult to quantify exactly how the outputs of PEO, Missiles and Space will be affected by these issues in the mid-to-longer-term and whether or not the desired reliability and availability output levels will be reached.

The final output area to be addressed is Foreign Military Sales (FMS). This output is significant both as a means to reduce per unit cost and as an indicator of the perceived capability gap of US products over those of other nations. During our interview with BG Cannon, he indicated PEO, Missiles and Space was experiencing declining trends in FMS as a result of competition from other nations. This is troubling for two reasons related to the strategic issues facing the PEO. First, FMS sales increase the total quantity of units produced—enabling economies of scale to be achieved which reduce the per unit cost of systems. Without these sales, the price for each US system goes up—requiring either greater funding levels or reduced quantities than originally planned. Additionally, these sales are valuable in managing the production flow. FMS can be utilized to fill the gaps between production runs for the US inventory that allow the production lines to stay active, thus avoiding start-up fees associated with bringing production back on line. The second reason declining FMS sales is troubling is that it signals there are other systems in the market that are perceived as better options than the ones being offered by PEO, Missiles and Space. (See Figure 9.)





Figure 9. Performance Gap is Closing
 (Program Executive Office, Missiles and Space, 2007, February)

If maintaining a capability gap and being a world leader in missile technologies is a required output of the organization, then declining FMS sales could indicate PEO, Missiles and Space is not producing its required outputs.

2. Analysis: Outputs

In the short-term, PEO, Missiles and Space has been able to meet its required outputs. The reduction in inputs has been accompanied by corresponding changes to the quantities of systems produced, and the support and services provided to the warfighter have not been degraded. This has resulted in a smaller, but still effective organization. Analysis of the mid-to-longer-term outputs is less conclusive. It is evident based on trends in the areas evaluated that the organization may not be able to fully meet future requirements. The declining quantities by both the US and FMS customers will drive the per-unit-cost up, making it difficult to produce desired outputs without first gaining efficiencies in the alignment of the

organization. Higher costs related to the stockpile reliability and the risk in this area will also adversely impact the outputs beyond the short-term.

C. OUTCOMES

1. Findings: Outcomes

The strategic issues identified in the Perfect Storm, and the issues related to them uncovered during research, are in most cases forecasts of anticipated outcomes of PEO, Missiles and Space. These unintended results are by products of the desired outputs and indicate how the PEO is performing or expected to perform in regards to the changing external environment. These outcomes are important because they indicate a cost to the organization's operations; they also serve as inputs to the external environment as feedback loops continuously process these most-recent results. There are two primary findings in this area. The first is industry's response to the Army's decreased funding and apparent shift away from missile systems in the short-term. As previously discussed in Chapter 3, industry takes its cues from the funding authorizations—which signal the Army's intentions. The signals sent by recent Army decisions to decrease investment in missile technologies, cancel developmental programs, and reduce production quantities of existing systems are signals that the future of missiles is not a bright one. The migration by engineers in critical missile technology fields into other disciplines has been industry's response to these signals. Why this is significant is that if the Army changes its position on missile systems and the role it is expected to play in future forces, the industrial base may not be able to immediately support the change in priorities. The outcome in this case is the increased response time necessary to meet the Army's changing needs. This dynamic could also be classified as risk. The Army's short-term shift in priorities may be acceptable—provided the risk does not exceed a threshold.

The second finding under outcomes involves the personnel and strategic issues identified in the Perfect Storm. In the same way that Army priorities send



signals to industry, they also send signals to the workforce. An outcome for PEO, Missiles and Space as a result of *PBD 753* is that SETA employee positions are in jeopardy and do not offer the same level of stability as in the past. This fact may persuade potential workers who value stability to take job opportunities with other organizations. This, in turn, will limit the potential employee pool and require the PEO to offer greater incentives to attract those who would otherwise be unwilling to take a job without the prospect of long-term employment.

2. Analysis: Outcomes

The two short-term outcomes identified above indicate the first signs of larger problems that PEO, Missiles and Space may face in the mid-to-longer-term. These initial findings validate, at least to a certain extent, the technical base and personnel arguments made in the PEO's recent strategic arguments. Although the impact of these outcomes does not threaten the PEO's ability to meet short-term outputs, they do represent a threat to their ability to meet requirements in years to come.

D. CHAPTER SUMMARY

There has been limited data in the form of results (culture, outputs and outcomes) produced by PEO, Missiles and Space since the identification of the Perfect Storm issues. Those which have been observed are just now feeding back into the organization and will likely drive future changes. Based on the results to date, it appears in the short-term the PEO has been able to meet required outputs and limit negative outcomes. The more troubling component in this analysis is that the initial indicators for the larger strategic issues warned of in the Perfect Storm and industrial base arguments made by the PEO appear to be present. The outcomes of decreased funding for research and development have already been processed by industry and their answer has been to move away from missile-related technologies. Personnel issues, specifically in the more technical positions, have not been realized to date; but the trends indicate problems may exist in the mid-to-longer-term. How the risks represented by these findings and analysis are processed and



subsequently used to shape the external environment will determine the future success or failure of PEO, Missiles and Space.

VI. CONCLUSIONS AND RECOMMENDATIONS

A. OVERVIEW

This chapter presents four overarching conclusions and recommendations resulting from an analysis of strategic issues facing PEO, Missiles and Space primarily over a mid-term timeframe (five years out). Senior executives composed and forwarded a strategic issues document which described the basics of four interrelated personnel, retirement and financial problem areas. This study collected data relative to these issues primarily through the use of semi-structured interviews conducted with approximately 12 officer and relevant civilian personnel. The benefits of this study include validating personnel concerns in the technical missile fields and, the identification of trends linking Army prioritizations with corresponding actions in industry. Recommendations are made suggesting possible alternatives for abating the vicious downward spiral missile technologies have entered into as a result of declining investment in development. This spiral and decline in the missile industry eventually generates an institutional loss of knowledge, thereby decreasing core capability in the missile arena and possibly degrading the development of future missile warfighting systems. The four conclusions are:

B. CONCLUSION ONE

PEO, Missiles and Space has formulated and is implementing an array of initiatives which are having a short-term positive effect in terms of mitigating and anticipating the effects of four interrelated issues initially outlined in the Perfect Storm.

Those initiatives are 1) Partnering with local universities, 2) Students Working at the Army in Parallel (SWAP), 3) Executions of road shows to promote



employment opportunities within the DoD, 4) Establishment of the Missile Systems Engineering Degree offered at University of Alabama, Huntsville, and 5) Implementation of the strategic workforce transformation plan. The current organization, operating procedures, and resourcing levels are capable of meeting required short-term outputs. Despite reduced funding in the most recent President's Budget and the continuing effects of cost efficiencies mandated by *PBD 753*, the organization appears in balance and capable of meeting directed requirements outlined in the most recent POM. The reduction in resources has been offset by efficiencies gained in the organization and through reductions in required outputs—specifically, the elimination of the APKWS, JCM, ATACMS programs, and significant reductions to the MEADS program.

Recommendations

PEO, Missiles and Space continue to reevaluate programs and assess changes to resourcing levels and requirements. The reinstatement of an eliminated program without sufficient resourcing could put the organization into an imbalanced state that adversely affects not only the reinstated program, but the other programs within the PEO.

PEO should identify and retain the critical technical personnel from the four programs that have been eliminated/reduced to ensure core technical capability resides within PEO, particularly during the next two to five years, which still contain uncertainty. Although carrying these personnel will come at a cost to the organization, the expertise of these limited resources may be necessary to offset any unanticipated rapid changes in the personnel structure as a result of BRAC and retirements.

C. CONCLUSION TWO

In the mid-to-longer time frame (five years out) PEO, Missiles and Space will likely experience a substantial “gap” in terms of having an (un)balanced



workforce capable of handling future requirements, particularly in the low-density technical positions.

This gap is primarily a result of both a lag in achieving newly initiated programs and mitigation measures, and an unclear future ability to hire, grow and retain technical-oriented personnel. Initiatives implemented by PEO, Missiles and Space to mitigate the looming personnel crisis identified in the Perfect Storm are not likely to fully alleviate the human resource problems central to this strategic issue. As discussed in Conclusion 1, balance is projected for the short-term; however, this balance does not appear to be maintainable into the mid- and long-term periods given current trends. The initiatives implemented by PEO, Missiles and Space to attract, train, and retain the next generation of missile system developers will be successful in the less technical positions with fewer educational and training requirements. For the positions requiring longer lead times to produce a productive employee, it appears there will be a three-to-four-year gap where these initiatives will not yet be producing the quantities of technical personnel required to offset losses to retirement and BRAC organizations.

Recommendations

Continue and expand upon the stated initiatives already implemented to attract, train, and retain personnel. Without these efforts, the organization will become less efficient and require a greater number of resources to meet the required outputs of the organization.

Seek relief from SETA hiring constraints until the expertise required has been grown within the core and matrix personnel pools. Failure to do this will result in a break in continuity and the loss of institutional knowledge critical to the efficient running and balance of the organization.

Should the current trends in reduced funding for RDT&E efforts and the cancellation of developmental programs continue, PEO, Missiles and Space may



need to reduce excess capability (people and facilities). A revamped structure would focus on the technical expertise needed to support already-fielded systems (and their modifications), and would considerably reduce all RDT&E requirements—i.e., perhaps by 90 percent. The current organization has been optimized based on the need for each Project Office to support systems in all phases of the lifecycle. The recent cancellation of programs and developmental efforts in Project Offices eliminates the need for the capability to be maintained in the majority of the Project Offices. Restructuring based on these trends would be advisable if the trends are expected to continue.

D. CONCLUSION THREE

The strategy of using “white papers” to raise attention and support for emerging and continuing PEO issues—although manageable in the short-term— appears to be inadequate to solve mid- and longer-term anticipated consequences.

Recommendations

PEO, Missiles and Space must gain the backing of the four supported BOS elements and the missile development industry to effectively address these issues. Formalize the current informal and ad hoc process of meeting and collaborating with all relevant stakeholders, i.e., form a stakeholder task force with sufficient power to influence more powerful stakeholders. This should be established to address current and future missile-related issues. This unified voice is required to compete for resources on a level playing field with organizations that by design or through their scope have a more centralized and focused effort.

Formalize a process for managing personnel inflows and outflows base-wide to ensure rational, equitable, and timely transitions of multiple streams of personnel, i.e., a central honest-broker, clearing-house. A neutral party must be appointed to oversee the personnel aspects of the transition of BRAC elements to Redstone Arsenal. There appears to be no higher echelon involvement in ensuring current



and transitioning organizations competition for personnel, particularly from matrix pools, does not result in an element becoming dysfunctional. This neutral party should be tasked with resolving personnel concerns of all stakeholders and be empowered to make decisions regarding these matters.

E. CONCLUSION FOUR

Cancellation of programs and reduced funding streams (e.g., RDT&E) have contributed to a vicious spiral. To the extent that the missile industry loses profitability and atrophies, a commensurate loss in institutional knowledge will likely occur, eventually adversely affecting missile warfighting capability in the field.

Decisions and anticipated personnel issues in missile-related technical positions have put the future of Army missile systems at risk. Intentionally or unintentionally, the combined effect of recent decisions has initiated a sequence of events that points toward a time when missile technologies will not be an integral part of military doctrine. Based on the actions industry has already taken in response to the Army's declining investment in future missile technologies, the expertise in this field will soon be lost unless signals are sent indicating this trend is not indicative of the future role of missiles in the force. The longer that decision-makers delay in terms of solving this macro problem, the more difficult intervention efforts will be—i.e., the greater the cost and time to regain lost capability.

Recommendations

Develop and present a detailed cost benefit analysis representing the risk associated with continued flat or declining investments in missile technologies. This analysis should include the estimated cost over time associated with delaying action and, subsequently, resulting in the need to rebuild this segment of the industrial base. Scenario analysis might also prove to be a useful tool in terms of quantifying the effects of degradation in US Army missile efforts, compared to several key adversaries.



Identify a mid- and long-term strategy for retaining personnel with critical missile experience. Based on current trends the pool of subject matter experts in the technical areas will continue to shrink. Even if trends are not reversed and there is no anticipated future for missile systems, the current inventory will need to be sustained until the end of its lifecycle. In order to provide sufficient oversight of the support contracted to provide this sustainment, the government will need to retain skilled personnel. Incentives comparable with those offered by industry will be necessary unless other retention mechanisms are employed.

F. CHAPTER SUMMARY

The conclusions above were made based on the facts and perceptions available at the time of this project. Many of the variables discussed are not anticipated to have an identifiable impact on PEO, Missiles and Space for several years out. As more time passes from the completion of this project and the assumptions and estimates these conclusions were based on are replaced by actual data points, more accurate recommendations can be made.

Further research and analysis of the technical aspects beyond the scope of this project will also reveal more concrete recommendations regarding the industrial base and the risks identified in this report. Additionally, we recommend follow-on research efforts focus on the industry and user communities perspectives of the issues analyzed in this project. Specifically, determining industries ability to respond to changes in the direction of missile development, and the using communities' expectations of missiles systems in future forces would complement the efforts of this report.



LIST OF REFERENCES

- Assistant Secretary of The Army for Financial Management and Comptroller. (2007). Retrieved from <http://www.asafm.army.mil/budget>; <http://www.asafm.army.mil/budget/fybm/fybm.asp>
- Bogosian, P., & Cannon, S.M. (2006, April 30). *Personnel crisis, Redstone Arsenal*. A White Paper.
- Bryson, J. M. (1995). *Strategic planning for public and nonprofit organizations: a guide to strengthening and sustaining organizational achievement*. San Francisco: Jossey-Bass Publishers.
- Business Manager. (2007, January 29-31). [Interview with researchers]. PEO, Missiles and Space, Redstone Arsenal, Alabama.
- Cannon, S., BG. (2007, January 29-31). [Interview with researchers]. PEO, Missiles and Space, Redstone Arsenal, Alabama.
- Cannon, S., BG. (2006, August 8). The looming crisis. Briefing presentation for the Graybeard Panel, August 8, 2006, in Huntsville, AL.
- Contracted Support Analyst. (2007, January 29-31). [Interview with researchers]. PEO, Missiles and Space, Redstone Arsenal, Alabama.
- Defense Base Closure and Realignment Commission. (2007). History of BRAC. Retrieved from <http://www.brac.gov/>
- Department of Defense. (2004). Program Budget Decision 753. Washington, DC: author.
- Department of Defense Comptroller. (2007a). *PPBE-Budgeting*. Retrieved from <http://www.dod.mil/comptroller/icenter/budget/budgphase.htm>.
- Department of Defense Comptroller. (2007b). *Budget History*. Retrieved from http://www.dod.mil/comptroller/icenter/budget/budget_history.htm.
- Department of Defense Statistical Analysis Information Division. Retrieved from <http://siadapp.dior.whs.mil/personnel/MILITARY/Miltop.htm>
- Ernst and Young. (2006, January). *The aging of the US workforce: Employer challenges and responses*. Publication for the Human Capital Institute.
- Grandrath, W.E. (2000). *Business process reform at Marine Corps installations: A systems perspective*. Monterey, CA: Naval Postgraduate School.



- Heritage Foundation. (2007). Retrieved March 2007, from www.heritage.org
- Human Resource Manager [2 of them, names not used for anonymity]. (2007, January 29-31). [Interview with researchers]. PEO, Missiles and Space, Redstone Arsenal, Alabama.
- Jones, L. R., & McCaffery, J. (2004, January 29). *Budgeting and financial management for national defense*. Charlotte, NC: Information Age Publishing.
- Lockwood, N.R. (2003). The aging workforce: the reality of the impact of older workers and eldercare in the workplace. *HR Magazine*, December.
- Office of Management and Budget. (2007). Retrieved from <http://www.whitehouse.gov/omb/budget/fy2008>
- Office of Personnel Management. (2007). Retrieved from <http://jobsearch.usajobs.opm.gov/>
- Parmer, C. (2006, September). PEO, Missiles and Space strategic workforce transformation plan. Presented at Redstone Arsenal, Alabama.
- Program Executive Office, Missiles and Space. (2007b). *2006-2007 Weapon Systems Book*.
- Program Executive Office, Missiles and Space. (2007a). Official Website. Supported programs. Retrieved January, 2007, from <http://www.msl.army.mil>
- Program Executive Office, Missiles and Space. (2007, February). *The declining missile business base: Are we taking too much risk?* Organizational published brief.
- Roberts, N. (2003, Fall). *Note on organizational System's framework*. Paper presentation. Monterey, CA: Naval Postgraduate School.
- Senior Budget Analyst. (2007, January 29-31). [Interview with researchers]. PEO, Missiles and Space, Redstone Arsenal, Alabama.
- Senior Leaders [3 of them, names not used for anonymity]. (2007, January 29-31). [Interview with researchers]. PEO, Missiles and Space, Redstone Arsenal, Alabama.
- Senior Personnel Officer. (2007, January 29-31). [Interview with researchers]. PEO, Missiles and Space, Redstone Arsenal, Alabama.



APPENDIX A. SEMI-STRUCTURED RESEARCH QUESTIONS

BACKGROUND

1. PEO, Missiles and Space consists of 1,447 personnel.
 - a. Which TDA is this based on?
 - b. How many of the positions are in the technical areas of concern?
2. Military specific technology areas listed as % of base on slide 10.
 - a. What is the “base”?
 - b. What does the reference to ~1000 lost man years represent?

PBD

1. *PBD 753* requires \$360 million in efficiencies from FY 06-11.
2. How these efficiencies gained briefed to Army Staff in April 2005.
 - a. Where is this brief?
3. PEO is to eliminate approximately 300 support contractor jobs between FY 07-09 with the intent of eliminating 100/year.
 - a. What is the status of this effort?
 - b. How many support contractors are currently on the payroll?

MATRIX

1. Matrix support has deteriorated since 1989/90.
 - a. Massive downsizing is based on personnel figures.
2. Part of strategy to meet PBD is to return matrix support.
 - a. How many over the effected timeframe?
 - b. Returning personnel to matrix-parent organizations is difficult because they have been charged with efficiencies as well. What efficiencies?
3. PEOs have rehired matrix personnel back into the organization to maintain required skill sets.
 - a. What numbers support this, and how were they obtained?
 - b. Has there been a gap created since the hiring freeze?

RETIREMENT

1. 50% of the workforce eligible to retire by FY-08 and 80% by FY-10.
 - a. What percentage within the technical positions?



- b. How have these figures changed since the white paper?
- 2. Current trends suggest 30-50% of those eligible will retire.
 - a. What does that translate into as far as total numbers?
 - b. Are the percentages different by division or organization?
- 3. Low estimate of 250 personnel retiring by FY 10.
 - a. Are these all vacancies or will some be backfilled?
 - b. How many openings with unfilled requisitions are there at present?
- 4. As of brief, 57% of AMCOM workforce over 50 years old?
 - a. What are these figures in the technical positions?
- 5. Multiple figures on slides 8 and 9 of brief concerning retirement.
 - a. What do these numbers represent in terms of issues?

BRAC

- 1. Approximately 4,700 government and 5,000 support contractor jobs will be moving to the RSA area.
 - a. What is the source of this data?
 - b. How many of these positions are in the technical areas?
- 2. 30-65% of personnel will not move to RSA creating vacancies.
 - a. Source of data?
 - b. What historically is known about the technical positions?
- 3. Influx begins in FY 07 and continues through FY-11.
 - a. What is the “master plan” for BRAC?
 - b. Who controls timetables?
 - c. Arriving units would seem to be more concerned about their ability to fill required technical positions. What are their concerns, and have they raised any issues to the DA level?
- 4. AMC, MDA, and SMDC are relocating to Huntsville and have similar required skills.
 - a. What are the TDAs of these organizations?
 - b. Are there any BRAC losses that will decrease personnel requirements?

IMPACT

- 1. Slide #3 illustrates three areas over the FY 08-10 timeframe that apparently will be impacted.



- a. What is/are the point(s) of this slide?
- 2. Since January 2006 (to time of brief) 50 personnel had been lost to retirement/reassignment/resignation, and 25 personnel had been hired. (B)
 - a. What positions are the 25 vacancies and how many (if any) were intentionally not filled?
- 3. Average age and years of experience of personnel hired were 10 and 9 years less than those lost.
 - a. Is this a good- or bad-news story?
 - b. Has there been any noticeable performance impact of these changes?
- 4. Strategic plan referenced on slide 11 with multiple components.
 - a. What is the detail or objectives for each of these components?
 - b. How successful have these efforts been to date?

SYSTEMS MODEL INPUTS

- 1. Environment/Context
 - a. Political
 - i. What are the challenges of balancing Perfect Storm and BRAC arguments?
 - ii. What are the perceived points of conflict with the arguments and who is making them?
 - iii. What are the actual differences?
 - iv. Will changes in control of the HASC/SASC/HAC/SAC have any significant impact?
 - v. Other?
 - b. Economic
 - i. How would you characterize the strength of the defense industrial base today in economic terms as it relates to PEO, Missiles and Space?
 - ii. How is the industrial base interpreting funding decisions such as *PBD 753*?
 - iii. How does the current competition for resources compare to that of the recent past?
 - iv. Other?
 - c. Social



- i. What impact has the decision had on the SETA and Matrix employees' sense of being integral members of the PEO, contributing to the organization accomplishing its mission?
 - ii. How have these decisions affected the Core members of the PEO?
 - iii. What social issues (if any) from the merger are still present?
 - iv. Other?
 - d. Technological
 - i. How would you characterize the pace at which the Missiles and Space industry is presently evolving?
 - ii. What training is necessary to remain abreast of the technological advances in the fields?
 - iii. What do the ideal and typical career paths for the technological fields look like?
 - iv. How important is understanding a particular system to general technological expertise?

2. Key Success Factors

- a. Given the political/economic/social/technological environment identified above, what has PEO, Missiles and Space identified as the critical elements in accomplishing their mission?
- b. Do you see these factors changing in the near or short term?



Initial Distribution List

1. Defense Technical Information Center
Ft. Belvoir, Virginia
2. Dudley Knox Library
Naval Postgraduate School
Monterey, California
3. Acquisition Research Program
Naval Postgraduate School
Monterey, California
4. Dr. Cary Simon
Naval Postgraduate School
Monterey, California
5. Dr. Keith Snider
Naval Postgraduate School
Monterey, California
6. Program Executive Office Missiles and Space
Executive Officer
Redstone Arsenal, Alabama
7. Karey L. Shaffer
Program Manager, Acquisition Research Program, GB
555 Dyer Road, Naval Postgraduate School, Monterey, CA 93943-5000

Copies of the Acquisition Sponsored Research Reports may be printed from our website www.acquisitionresearch.org



THIS PAGE INTENTIONALLY LEFT BLANK



2003 - 2006 Sponsored Acquisition Research Topics

Acquisition Management

- Software Requirements for OA
- Managing Services Supply Chain
- Acquiring Combat Capability via Public-Private Partnerships (PPPs)
- Knowledge Value Added (KVA) + Real Options (RO) Applied to Shipyard Planning Processes
- Portfolio Optimization via KVA + RO
- MOSA Contracting Implications
- Strategy for Defense Acquisition Research
- Spiral Development
- BCA: Contractor vs. Organic Growth

Contract Management

- USAF IT Commodity Council
- Contractors in 21st Century Combat Zone
- Joint Contingency Contracting
- Navy Contract Writing Guide
- Commodity Sourcing Strategies
- Past Performance in Source Selection
- USMC Contingency Contracting
- Transforming DoD Contract Closeout
- Model for Optimizing Contingency Contracting Planning and Execution

Financial Management

- PPPs and Government Financing
- Energy Saving Contracts/DoD Mobile Assets
- Capital Budgeting for DoD
- Financing DoD Budget via PPPs
- ROI of Information Warfare Systems



- Acquisitions via leasing: MPS case
- Special Termination Liability in MDAPs

Logistics Management

- R-TOC Aegis Microwave Power Tubes
- Privatization-NOSL/NAWCI
- Army LOG MOD
- PBL (4)
- Contractors Supporting Military Operations
- RFID (4)
- Strategic Sourcing
- ASDS Product Support Analysis
- Analysis of LAV Depot Maintenance
- Diffusion/Variability on Vendor Performance Evaluation
- Optimizing CIWS Life Cycle Support (LCS)

Program Management

- Building Collaborative Capacity
- Knowledge, Responsibilities and Decision Rights in MDAPs
- KVA Applied to Aegis and SSDS
- Business Process Reengineering (BPR) for LCS Mission Module Acquisition
- Terminating Your Own Program
- Collaborative IT Tools Leveraging Competence

A complete listing and electronic copies of published research within the Acquisition Research Program are available on our website: www.acquisitionresearch.org





ACQUISITION RESEARCH PROGRAM
GRADUATE SCHOOL OF BUSINESS & PUBLIC POLICY
NAVAL POSTGRADUATE SCHOOL
555 DYER ROAD, INGERSOLL HALL
MONTEREY, CALIFORNIA 93943

www.acquisitionresearch.org