



Calhoun: The NPS Institutional Archive
DSpace Repository

Theses and Dissertations

1. Thesis and Dissertation Collection, all items

2002-09

**Enterprise Resource Planning (ERP) : a case
study of Space and Naval Warfare Systems
Center San Diego's Project Cabrillo**

Hoffman, Dean M.; Oxendine, Eric

Monterey, California. Naval Postgraduate School

<https://hdl.handle.net/10945/4714>

This publication is a work of the U.S. Government as defined in Title 17, United States Code, Section 101. Copyright protection is not available for this work in the United States.

Downloaded from NPS Archive: Calhoun



Calhoun is the Naval Postgraduate School's public access digital repository for research materials and institutional publications created by the NPS community. Calhoun is named for Professor of Mathematics Guy K. Calhoun, NPS's first appointed -- and published -- scholarly author.

Dudley Knox Library / Naval Postgraduate School
411 Dyer Road / 1 University Circle
Monterey, California USA 93943

<http://www.nps.edu/library>

NAVAL POSTGRADUATE SCHOOL
Monterey, California



THESIS

**ENTERPRISE RESOURCE PLANNING (ERP): A CASE
STUDY OF SPACE AND NAVAL WARFARE SYSTEMS
CENTER SAN DIEGO'S PROJECT CABRILLO**

by

Eric Oxendine
Dean M. Hoffman IV

September 2002

Thesis Advisor: Lawrence R. Jones
Co-Advisor: John Mutty

Approved for public release; distribution unlimited

THIS PAGE INTENTIONALLY LEFT BLANK

REPORT DOCUMENTATION PAGE			Form Approved OMB No. 0704-0188	
Public reporting burden for this collection of information is estimated to average 1 hour per response, including the time for reviewing instruction, searching existing data sources, gathering and maintaining the data needed, and completing and reviewing the collection of information. Send comments regarding this burden estimate or any other aspect of this collection of information, including suggestions for reducing this burden, to Washington headquarters Services, Directorate for Information Operations and Reports, 1215 Jefferson Davis Highway, Suite 1204, Arlington, VA 22202-4302, and to the Office of Management and Budget, Paperwork Reduction Project (0704-0188) Washington DC 20503.				
1. AGENCY USE ONLY (Leave blank)		2. REPORT DATE September 2002		3. REPORT TYPE AND DATES COVERED Master's Thesis
4. TITLE AND SUBTITLE Enterprise Resource Planning (ERP): A Case Study Of Space And Naval Warfare Systems Center San Diego's Project Cabrillo			5. FUNDING NUMBERS	
6. AUTHOR (S) Eric Oxendine and Dean M. Hoffman IV				
7. PERFORMING ORGANIZATION NAME(S) AND ADDRESS(ES) Naval Postgraduate School Monterey, CA 93943-5000			8. PERFORMING ORGANIZATION REPORT NUMBER	
9. SPONSORING / MONITORING AGENCY NAME(S) AND ADDRESS(ES)			10. SPONSORING/MONITORING AGENCY REPORT NUMBER	
11. SUPPLEMENTARY NOTES The views expressed in this thesis are those of the author and do not reflect the official policy or position of the U.S. Department of Defense or the U.S. Government.				
12a. DISTRIBUTION / AVAILABILITY STATEMENT Approved for public release; distribution unlimited			12b. DISTRIBUTION CODE	
<p>13. ABSTRACT (maximum 200 words)</p> <p>This thesis examines the Enterprise Resource Planning (ERP) pilot implementation conducted at the Space and Naval Warfare Systems Center San Diego (SSC-SD), the first of four Department of the Navy (DON) pilot implementations. Specifically, comparisons are drawn between both successful and unsuccessful ERP implementations within private sector organizations and that of SSC-SD. Any commonalities in implementation challenges could be applied to future ERP implementations in both the DON and Department of Defense (DOD). The findings are based in part upon interviews and data collected. From the comparison, commonalities exist in ERP implementation challenges between private sector organizations and SSC-SD. Additionally the management techniques used to mitigate those challenges are similar. Finally, due to SSC-SD's financial management structure and appropriated funding constraints, unique obstacles were identified during the implementation. These unique obstacles will be encountered by other Working Capital Funded (WCF) organizations planning to implement ERP on the same scale as SSC-SD. This thesis supports that the implementation of ERP at SSC-SD was a success based on industry comparisons, the goals of Project Cabrillo's business case analysis (BCA), and its Chief Financial Officer (CFO) Act compliancy assessment, January 2002.</p>				
14. SUBJECT TERMS Enterprise Resource Planning, Financial Management, Project Cabrillo, Space and Naval Warfare Systems Center San Diego, SSC-SD			15. NUMBER OF PAGES 165	
			16. PRICE CODE	
17. SECURITY CLASSIFICATION OF REPORT Unclassified	18. SECURITY CLASSIFICATION OF THIS PAGE Unclassified	19. SECURITY CLASSIFICATION OF ABSTRACT Unclassified	20. LIMITATION OF ABSTRACT UL	

NSN 7540-01-280-5500

Standard Form 298 (Rev. 2-89)
Prescribed by ANSI Std. Z39-18

THIS PAGE INTENTIONALLY LEFT BLANK

Approved for public release; distribution unlimited

**ENTERPRISE RESOURCE PLANNING (ERP): A CASE STUDY OF SPACE
AND NAVAL WARFARE SYSTEMS CENTER SAN DIEGO'S PROJECT
CABRILLO**

Eric Oxendine
Lieutenant Commander, United States Navy
B.A., University of North Carolina, 1992

Dean M. Hoffman IV
Captain, United States Army
B.A., Lycoming College, 1991

Submitted in partial fulfillment of the
requirements for the degree of

MASTER OF SCIENCE IN MANAGEMENT

from the

**NAVAL POSTGRADUATE SCHOOL
September 2002**

Authors: Eric Oxendine
Dean M. Hoffman IV

Approved by: Lawrence R. Jones
Thesis Advisor

John Mutty
Co-Advisor

Douglas A. Brook
Dean, Graduate School of Business and Public
Policy

THIS PAGE INTENTIONALLY LEFT BLANK

ABSTRACT

This thesis examines the Enterprise Resource Planning (ERP) pilot implementation conducted at the Space and Naval Warfare Systems Center San Diego (SSC-SD), the first of four Department of the Navy (DON) pilot implementations. Specifically, comparisons are drawn between both successful and unsuccessful ERP implementations within private sector organizations and that of SSC-SD. Any commonalities in implementation challenges could be applied to future ERP implementations in both the DON and Department of Defense (DOD). The findings are based in part upon interviews and data collected.

From the comparison, commonalities exist in ERP implementation challenges between private sector organizations and SSC-SD. Additionally the management techniques used to mitigate those challenges are similar. Finally, due to SSC-SD's financial management structure and appropriated funding constraints, unique obstacles were identified during the implementation. These unique obstacles will be encountered by other Working Capital Funded (WCF) organizations planning to implement ERP on the same scale as SSC-SD. This thesis supports that the implementation of ERP at SSC-SD was a success based on industry comparisons, the goals of Project Cabrillo's business case analysis (BCA), and its Chief Financial Officer (CFO) Act compliancy assessment, January 2002.

THIS PAGE INTENTIONALLY LEFT BLANK

TABLE OF CONTENTS

I.	INTRODUCTION	1
	A. BACKGROUND	1
	B. PURPOSE	3
	C. RESEARCH QUESTIONS	4
	1. Primary	4
	2. Secondary	4
	D. EXPECTED BENEFITS OF STUDY	4
	E. SCOPE OF THESIS	5
	F. METHODOLOGY	5
	G. ORGANIZATION OF STUDY	6
II.	BACKGROUND	9
	A. DEFINITION	9
	B. HISTORY OF ERP	12
	1. Private Sector	12
	2. Public Sector	17
	a. 1990 Chief Financial Officers (CFO) Act	18
	b. 1993 Government Performance and Results Act (GPRA)	18
	c. 1994 Government Management Reform Act (GMRA)	19
	d. 1996 Federal Financial Management Improvement Act (FFMIA)	19
	e. 1996 Clinger-Cohen Act	19
	3. Current Public Sector ERP Initiatives	20
	a. The United States Mint	20
	b. The Strategic Petroleum Reserve	21
	c. Department of Defense	22
	d. Department of the Navy	24
III.	SPACE & NAVAL WARFARE SYSTEMS CENTER-SAN DIEGO (SSC-SD) AND ENTERPRISE RESOURCE PLANNING (ERP): AN OVERVIEW	27
	A. INTRODUCTION	27
	B. HISTORY OF SSC-SD	27
	1. Organization	27
	2. Products	28
	3. Resources	29
	C. SSC-SD AND ERP	32
	1. ERP Pilot Selection	32
	2. Plan Development	33
	3. Software Selection	38
	4. Go Live	40

IV. LESSONS FROM INDUSTRY	43
A. INTRODUCTION	43
B. ERP ADVANTAGES	43
1. Elimination Of Costly, Inflexible Legacy Systems	43
2. Improvement of Current Business Processes ...	44
3. Improved Decision-Making Capabilities	44
4. Reduced Paper Documents	44
5. Greater Accuracy Of Information With Detailed Content	45
6. Improved Cost Control	45
7. Decrease In Customer Response Time	45
8. Decreased Cycle Time Of Payments	46
9. Improved International Operations	46
10. ERP Provides Functionality to Interact With Other Modules	47
11. Single-Vendor Approach	47
12. Web Based Applications	47
B. ERP DISADVANTAGES	47
1. Implementation Time	47
2. Expense Of Implementation	48
a. <i>Training</i>	49
b. <i>Integration, Testing, and Maintenance</i> ..	49
c. <i>Data Conversion</i>	49
d. <i>Data Analysis</i>	49
e. <i>Consultants</i>	50
f. <i>Replacing The Best And Brightest</i>	50
g. <i>Implementation Teams Can Never Stop</i> ...	50
h. <i>Waiting for Return of Investment (ROI)</i> .	51
i. <i>Post ERP Depression</i>	51
3. Risk Of Using One Vendor	52
4. Security Issues	53
C. LESSONS LEARNED FROM THE PRIVATE SECTOR:	53
1. Business Case Analysis (BCA)	54
2. Metrics	56
a. <i>5 (+ or -2) Rule</i>	56
b. <i>Linked To Value</i>	57
c. <i>Meaningful</i>	57
d. <i>Timely</i>	57
e. <i>Appropriate Standards Used</i>	58
3. Senior Leadership Commitment	58
4. Return On Investment (ROI)	58
a. <i>Create A List</i>	60
b. <i>Bring IT and Finance Together</i>	60
c. <i>Have ROI Benefits That Are Auditable</i> ...	61
d. <i>Soft Benefits Matter</i>	61

	e.	Factor In Productivity Discounts	61
	f.	Separate Proposals	61
	g.	Ensure That ROI Benefits are Staggered .	62
5.		Change Management	62
	a.	Communicate! Communicate! Communicate! .	63
	b.	Rule of Fifties	64
	c.	Benefits Sell, But Features Do Not!	64
	d.	Make Your Pitch Distinctive And Vivid ..	64
	e.	Segment Your Market	64
	f.	Never, Ever Lie, Not Even A Little	64
6.		Productivity Dip	65
	a.	Use Of Pilot Systems Or "Sandboxes"	66
	b.	"Superuser" Involvement	66
	c.	Excellent Project Execution	66
	d.	Continuous Involvement Of Senior Leadership	66
7.		Personnel Recruitment, Teambuilding, and Retention	66
8.		Document	68
9.		Data Integration	68
	a.	Business Objectives	69
	b.	Weak Project Specifications Will Blow More Than Just The Budget	69
	c.	Most Data Are "Dirtier" Than One Might Expect	69
	d.	Once Is Never Enough	69
	e.	Take Charge Of Project Management	70
	f.	Monitor Transmissions To Avoid Fatal Bottlenecks	70
	g.	Do Not Forget Training and Support ...	70
10.		Costs	70
	a.	Eliminate Inefficient Legacy Systems ...	71
	b.	Buy Commercial-Off-The-Shelf (COTS)	71
	c.	Know The Contract	72
	d.	Time Is Money	72
	e.	Focus More On Value And Not Costs	73
	f.	Money Talks, Use Incentives	73
	g.	Avoid "Big Bang" Approach, Release In A Series	73
	h.	Funding Of Major Functionality Additions And Major Release Upgrades Should Be Treated As Funded Capital Projects	74
	i.	Centralize Help Desk	74
	j.	Benchmark IT Expenditures Against Competition	74

11.	Training	75
a.	<i>Set Up Feedback Loops</i>	75
b.	<i>Train Workers "Just In Time"</i>	76
c.	<i>Small Workshops With Technical Experts In Mock Working Environment</i>	76
12.	Maintenance And Support	76
13.	Security	77
D.	SUMMARY	77
V.	ERP IMPLEMENTATION COMPARISON: SPACE AND NAVAL WARFARE SYSTEMS CENTER SAN DIEGO (SSC-SD) AND COMMERCIAL INDUSTRY	79
A.	INTRODUCTION	79
B.	COMMONALITIES WITH PRIVATE SECTOR	79
1.	Business Case Analysis	79
2.	Commercial-Off-The-Shelf (COTS) Business Processes	80
3.	Project Metrics	81
4.	Training	88
5.	Data	89
C.	SSC-SD UNIQUE ERP IMPLEMENTATION OBSTACLES	93
1.	Memorandums Of Agreement (MOA)	93
2.	Government Processes In A Commercial System .	94
a.	<i>Work Received</i>	95
b.	<i>Funds Processing</i>	96
c.	<i>Authorization</i>	96
d.	<i>Controls</i>	97
e.	<i>Additional Efficiencies</i>	99
3.	Ramp Up	101
D.	SUMMARY	103
VI.	CONCLUSIONS AND RECOMMENDATIONS	105
A.	SUMMARY	105
B.	RESEARCH QUESTION	106
1.	Primary: Given the current constraints within the Department of Defense (DOD) on infrastructure investment, what aspects of an ERP implementation must be closely managed in order to increase success?	106
a.	Business Case Analysis (BCA) Development	106
b.	Metrics	107
c.	Senior Leadership Commitment	107
d.	Return on Investment (ROI)	107
e.	Change Management	108
f.	Productivity Dip	108

	g.	<i>Personnel Recruitment, Teambuilding, and Retention</i>	108
	h.	<i>Document</i>	109
	i.	<i>Data Integration</i>	109
	j.	<i>Costs</i>	109
	k.	<i>Training</i>	110
	l.	<i>Maintenance & Support</i>	110
	m.	<i>Security</i>	110
2.	Secondary:		111
	a.	<i>What commonalities exist between Space and Naval Warfare Systems Support Center San Diego (SSC-SD) Project Cabrillo implementation and those of private sector organizations?</i>	111
	b.	<i>What were the unique obstacles discovered during Project Cabrillo's implementation.</i>	113
	c.	<i>Can such challenges be overcome and, if so, how?</i>	116
B.	CONCLUSIONS		117
C.	RECOMMENDATIONS		118
D.	AREAS FOR FURTHER RESEARCH		119
APPENDIX A	DETAILED HISTORY OF ERP		121
APPENDIX B	PREDOMINATE ERP PROVIDERS		123
	1.	SAP	123
	2.	Oracle Corporation.	124
	3.	Peoplesoft	124
	4.	J.D. Edwards	125
	5.	Baan	125
APPENDIX C	COMMON ERP SOLUTIONS		127
APPENDIX D	PROJECT CABRILLO 10 YEAR ECONOMIC ANALYSIS		129
APPENDIX E	PROJECT CABRILLO 10 COST BENEFIT ANALYSIS		131
	LIST OF REFERENCES		133
	INITIAL DISTRIBUTION LIST		147

THIS PAGE INTENTIONALLY LEFT BLANK

LIST OF FIGURES

Figure 2.1.	ERP Solutions (From: Ref. 7)	10
Figure 2.2.	ERP by Example (After: Ref. 9)	11
Figure 2.3.	History of ERP (From: Ref. 18)	12
Figure 3.1.	SSC-SD Evolution (From: Ref. 33)	28
Figure 3.2.	NWCF: A Graphical Overview (From: Ref. 36) .	30
Figure 3.3.	SSC San Diego FY 2001 Total Funding by Appropriation (From: Ref. 33)	31
Figure 3.4.	SSC San Diego Resource Base (From: Ref. 33)	32
Figure 3.5.	"As Is" Business Model (SSC SD) (From: Ref. 39)	34
Figure 3.6.	"To Be" Business Model (Project Cabrillo (From: Ref. 39)	35
Figure 3.7.	Gartner Group ERP Implementation Recommendations (From: Ref. 39)	37
Figure 3.8.	Project Cabrillo Wave One Schedule (From: Ref. 38)	37
Figure 3.9.	SAP R/3 Architecture (From: Ref. 38)	39
Figure 5.1.	Net Operating Results Metric Tree (From: Ref. 38)	83
Figure 5.2.	Revenue Growth Metric Tree (From: Ref. 38) .	84
Figure 5.3.	Working Capital Metric Tree (From: Ref. 38)	85
Figure 5.4.	Balanced Scorecard for Cabrillo's Nine KPIs (From: Ref. 38)	86
Figure 5.5.	Project Cabrillo KPI Status and Goals January 2002 (From: Ref. 74)	87
Figure A.1.	Detailed History of ERP (From: Ref. 10) ...	122
Figure B.1.	Market Share (From: Ref. 15)	123
Figure D.1.	Project Cabrillo 10 Year Economic Analysis (From: Ref. 38)	129
Figure E.1.	Project Cabrillo 10 Year Cost Benefit Analysis (From: Ref. 38)	131

THIS PAGE INTENTIONALLY LEFT BLANK

ACKNOWLEDGEMENTS

The quality of this thesis was greatly enhanced by the guidance, patience, and expertise provided by:

Naval Postgraduate School:

Professor Lawrence R. Jones, Thesis Advisor
CAPT John Mutty, USN (Ret.) Thesis Co-Advisor
LCDR Glenn R. Cook, SC, USN
CDR Phillip J. Candreva, SC, USN

Space and Naval Warfare Systems Command:

RADM Kenneth D. Slaght, USN
Ms. Sarah Lamade
CAPT Kevin F. Spalding, USN

Space and Naval Warfare Systems Center San Diego:

Mr. Randy B. Volker
Mr. Michael H. Nguyen
Mr. Bob Frye
Mrs. Carmen S. Fendlemen
Mr. John R. Gorman
Ms. Helen Topacio

Northrop Grumman:

Mr. Doug Timmer
Mr. Tim Reese
Ms. Kimberly A. Dorey

Strategic Petroleum Reserve:

Mr. John O'Brien

THIS PAGE INTENTIONALLY LEFT BLANK

I. INTRODUCTION

A. BACKGROUND

In 1998, under the auspices of the Department of Navy's (DON) Revolution in Business Affairs (RBA), the Commercial Business Practices (CBP) Working Group, led by VADM John Lockard, Commander, Naval Air Systems Command (COMNAVAIRSYSCOM), selected Enterprise Resource Planning (ERP) as a foundation and lever for change for the DON from "Cold War" business practices to better business practices as exemplified by leaders in commercial industry. Six "Beta Tests" were undertaken to properly assess whether ERP was the right tool to:

- Provide improved decision quality information to all levels of management.
- Improve efficiency and effectiveness (better, faster, cheaper) through reengineered business processes and integrated information to managers.
- Manage costs for maximum reallocation of resources to recapitalization and modernization.
- Enable compliance with statutory requirements

Specifically within the public sector, Enterprise Resource Planning (ERP) is a relatively new approach for the integrated management of resources and processes in an enterprise. ERP functions on a relational database concept utilizing an integrated set of applications that span functional "silos" of an enterprise (e.g. human resources, financial management, inventory management, production, etc.). ERP standardizes company processes, integrates

operations, reengineers business processes, optimizes the supply chain, and increases flexibility [Ref. 1]. It provides consistent information from common data as a basis for timelier decision-making and improved performance at all levels of management.

Since the election of President George W. Bush and his appointment of Donald Rumsfeld as Secretary of Defense, the implementation of better business practices and the improvement of financial management/decision support systems have been top priorities.

...Without accurate and timely financial information, it is not possible to accomplish my agenda to secure the best performance and highest measure of accountability for the American people... [Ref. 2]

One of my highest priorities is to have reliable, accurate and timely financial management information upon which to make the most effective business decisions. Because we do not always have that information, we must change the Department's business operations and systems [Ref. 3].

Their goals for better business practice and financial management information system reformation throughout the DOD are a continuation of the Revolution in Business Affairs (RBA) mission and the requirements of the 1997 Defense Reform Initiative (DRI) [Ref. 3]. However, with the current focus on weapons system investment, infrastructure disinvestments, and the "War on Terrorism", investment initiatives for ERP systems may lose priority

due to their complexity, cost, and the perception that they are an investment in infrastructure.

B. PURPOSE

In 2000, the original six ERP "Beta Tests" were reduced to four due to reductions in funding. The remaining four pilots are currently assessing ERP's capabilities in the following areas:

- Financial Management (Project Cabrillo) The Space and Naval Warfare Systems Command's (SPAWARSYSCOM) Space and Naval Warfare Systems Center San Diego (SSC-SD) is leading this effort.
- Program Management. The Naval Air Systems Command (NAVAIRSYSCOM) is leading this effort.
- Supply Chain Management. Both NAVAIRSYSCOM and the Naval Supply Systems Command (NAVSUPSYSCOM) are leads in this effort.
- Regional Maintenance. Both the Naval Sea Systems Command (NAVSEASYSYSCOM) and Commander in Chief, United States Atlantic Fleet (CINCLANTFLT) are leads in this effort.

On 2 July 2001, Project Cabrillo, led by the Space and Naval Warfare Systems Center, San Diego (SSC-SD), an echelon three Navy Working Capital Fund (NWCF) entity, was the first of the remaining four ERP "Beta Tests" to successfully attain "Wave 1" of four wave implementation milestones. Though Project Cabrillo's implementation has been deemed a success, ERP continues to be viewed by many as a high-risk venture in the light of limited resources critical to the frontline needs of the war-fighter in the

Navy and DOD [Ref. 4]. Given the complexity and the average cost of one full ERP implementation (documented costs range from \$400,000 to \$300 million), this thesis will explore specific areas in an ERP implementation that organizations pursuing an enterprise solution should properly manage in order to minimize risk and control cost. These options will be assessed for their applicability to other Navy commands and the DOD.

C. RESEARCH QUESTIONS

1. Primary

Given the current constraints within the Department of Defense (DOD) on infrastructure investment, what aspects of an ERP implementation must be closely managed in order to increase success?

2. Secondary

- What commonalities exist between Space and Naval Warfare Systems Center San Diego (SSC-SD) Project Cabrillo implementation and those of private sector organizations?
- What were the unique obstacles discovered during Project Cabrillo's implementation.
- Can such obstacles be overcome and, if so, how?

D. EXPECTED BENEFITS OF STUDY

This study will provide information needed by DON and DOD leadership to determine what actions should be taken to properly manage an ERP implementation to ensure success while optimizing the efficiencies afforded by the system.

E. SCOPE OF THESIS

This study provides background on ERP in both private and public sectors to include the recent success of SSC-SD (Project Cabrillo). Of these organizations, analysis will focus on the management of an ERP implementation project in order to attain an effective and affordable system. Additionally, structured interviews were conducted with key stakeholders and beneficiaries to determine what are the "keys to success" and "pitfalls" to avoid with an ERP implementation. The end results of this research will provide guidance for other DON organizations, DOD organizations, and other public organizations planning to implement an ERP system.

F. METHODOLOGY

The methodology used in this thesis included the following:

- A comprehensive literature review of all DON ERP pilot program business case analyses, case analyses of commercial sector ERP ventures, General Accounting Office Reports, DOD Information Technology (IT) policy, United States Congressional legislation, and assorted internet sources to include: CIO.com, Defense Acquisition Desktop, ERP Research Center, Navy ERP Home Page, ERP Central, Government E-Federal Web site, Information Week, IT Toolbox for ERP, PeopleSoft, SAP, Technology Evaluation, Tech Web, and Computer World.
- Interviews with officials involved in the implementation of ERP systems and users of ERP systems in the Department of Defense, the

Department of Treasury, the Department of Energy, and Northrop Grumman.

- Analysis of the findings to identify common lessons learned in managing an ERP project.

G. ORGANIZATION OF STUDY

Chapter II outlines the evolution of ERP in both the public sector and private sector.

Chapter III is a case analysis of Space and Naval Warfare Systems Center San Diego (SSC-SD) outlining: history of the command; current ("As Is") business practices; post ERP processes ("To Be"); and ERP business case analysis (BCA) development.

Chapter IV examines commercial sector implementations of ERP. In doing so, the advantages and disadvantages of ERP are highlighted along with key lessons learned from ERP implementations.

Chapter V outlines commonalities between SSC-SD's ERP implementation and those of the private sector. Specifically, unique challenges are identified due to the constraints on governmental financial management and the magnitude of the transition.

Chapter VI answers the primary and secondary questions of this thesis and provides recommendations for additional

research. Additionally, a recommendation of the next steps for ERP and the DON is outlined.

THIS PAGE INTENTIONALLY LEFT BLANK

II. BACKGROUND

A. DEFINITION

Enterprise Resource Planning (ERP) is a structured approach to optimizing a company's internal value chain. The software is fully installed across the entire enterprise. It connects the components of the enterprise through a logical transmission and sharing of common data [Ref. 5].

Enterprise Resource Planning (ERP) is a software solution that addresses the enterprise needs taking the process view of an organization to meet the organizational goals tightly integrating all functions of an enterprise [Ref. 6].

Enterprise Resource Planning (ERP) is multi-module application software that integrates all departmental functions across an enterprise into one single computer system. The end result is one system serving all departmental needs with a single database (Figure 2.1). Information can be shared while inefficient, non-integrated legacy systems are eliminated.



Figure 2.1. ERP Solutions (From: Ref. 7)

ERP can be broken down into three basic levels: planning, execution, and analysis. The planning level includes supply chain, manufacturing, budgeting, and sales operations. The execution level includes production systems. Tools available in production systems include: process modeling, inventory, logistics (e.g., order entry, inventory management, shipping, and transportation), procurement, human resources and maintenance. The analysis level includes costing (e.g., product costing, production costing, etc.), financials (e.g. payables, receivables, general ledger, etc.), budgeting and sales analysis [Ref. 8].

The end result is: 1) ease in the exchange of data among corporate divisions 2) the unification of all major business practices with a single family of software 3) the

ability to run process modules on client/server networks 4) the connection of personal computers (PCs) to more powerful computers and 5) creating modules that work separately performing specific data-processing functions. This integration of business processes that optimize functions across the enterprise has led to ERP being described as a revolutionary change in business processes for dramatic improvements. Figure 2.2 provides an example of a typical manufacturing order processed with an ERP system.

The following is a typical order placed on an ERP system:

1. Clerk enters order for "widgets".
2. ERP checks the Bill of Materials (BOM) Module for required parts.
3. Inventory-management module automatically determines material availability and will initiate required purchase order requests for out-of-stock material.
4. Other modules determine what machines will be needed to make the "widgets".
5. Finally, the shop floor module creates the work order.
6. Simultaneously, the billing module creates an invoice.

Note: Through the use of bar-codes, Radio Frequency (RF), and Global Positioning System (GPS), it is possible to track the progress of an order through every step of the manufacturing process which helps customer service respond to requests for early delivery or order status.

Figure 2.2. ERP by Example (After: Ref. 9)

B. HISTORY OF ERP

1. Private Sector

Today's ERP is a result of forty years of trial and error in the development of systems to automate the management of manufacturing operations from order entry to final product delivery (Figure 2.3). For a detailed history, refer to Appendix A.

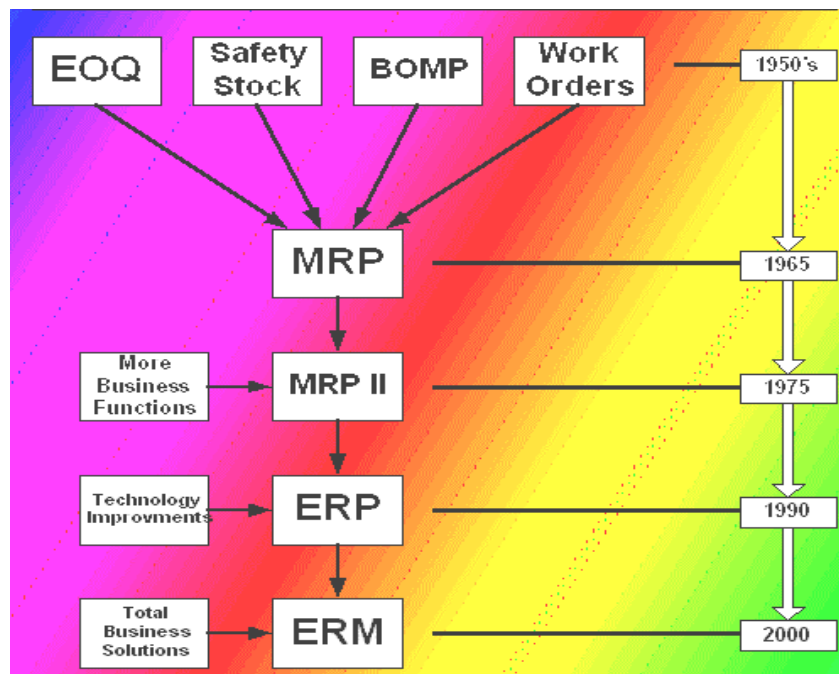

Figure 2.3. History of ERP (From: Ref. 18)

Before the 1960s, inventory was managed using several different manual management tools to include: Economic Order Quantity (EOQ), Safety Stock, Bill of Material Processing (BOMP) and Work Orders. Economic Ordering Quantity (EOQ) analyzed order and carrying costs. Based on historical demand and "not-in-stock" (NIS) occurrences, Safety Stock ensured material would be on-hand, minimizing

NIS and meeting customer demand. However, this required producers to carry larger amounts of inventory, translating into additional costs. Bill of Materials Process (BOMP) was the process in which suppliers received payment for raw materials or services. This process was long and tedious because it required several actions. The suppliers mailed the bill of material (BOM), awaited payment from the customer, and had to allow the transaction to clear prior to having access to the needed capital.

In the 1960s, computers were introduced to the manufacturing process to improve planning for the use of materials and production requirements. This marriage of computer technology and planning is called Material Requirements Planning (MRP). MRP is a more proactive approach in managing production and inventory. MRP uses the universal manufacturing equation [Ref. 73]:

- What are we going to make?
- What does it take to make it?
- What do we have?
- What do we have to get?

MRP automates the universal manufacturing schedule using a master schedule (What are we going to make?), the bill of material (What does it take to make it?), and inventory records (What do we have?) to determine future requirements (What do we have to get?).

In the 1970s, a separate module, the Capacity Requirements Module (CRM) was created. This was the first attempt to combine two separate modules, Capacity Requirements Planning (CRP) and the Master Planning Schedule (MPS). It was referred to as "Closed Loop MRP" because the CRP provided feedback to the MPS regarding the available capacity to produce. It was these advances in programming and integrating other resources that led to the development of MRP II in 1975.

MRP II was the next evolutionary step in the computerized automation of manufacturing planning and operations. MRP II proceeded to provide more business functions. It linked together functions such as, Business Planning, Production Planning, Master Production Scheduling, Material Requirements Planning, Capacity Requirements Planning and the execution system for capacity and priority [Ref. 11]. This was accomplished by including production plans from the shop floor and the distribution centers.

In the 1990s, MRP II was further expanded to cover areas to include: Engineering, Finance, Human Resources, and Project Management. The complete gamut of activities within any business enterprise was combined into one software program; hence the term Enterprise Resource Planning (ERP) was coined. [Ref. 6]

By the late 1990s, a large number of companies upgraded their current information systems architecture. One reason for this was the threat of their old or legacy systems not being Year 2000 (Y2K) compliant. In an effort to eliminate this potential problem and attain the latest business software, several companies turned to ERP. The end result was that 64% of worldwide organizations information technology (IT) investment was for ERP application software totaling \$27 billion [Ref. 12]. The following are a few of the larger Fortune 500 firms that have successfully implemented ERP [Ref. 13]:

- Northrop Grumman
- IBM
- Compaq
- General Electric
- Hershey
- Bausch & Lomb

At the beginning of the 21st century, the United States economy began to decline, forcing companies to tighten their budgets. Information technology (IT) budgets were the first to be cut since the Y2K threat had passed. Additionally, numerous horror stories circulated about failed ERP implementations resulting in large capital investments with minimal return. The end result was a drop in ERP system sales [Ref. 14].

In the meantime, the Internet was becoming more secure and the ERP vendors saw a window of opportunity to revive ERP, making it even more beneficial by extending its reach to information through the web. The Gartner Group, which coined the phrase "ERP II", publicized this new form of ERP. ERP II was a major paradigm shift from traditional ERP applications that only focused on internal data gathering and management processes. ERP II provides information to partners, vendors, and customers externally via the Internet [Ref. 14]. Consequently, business partners from multiple companies can exchange information posted on e-commerce exchanges daily.

Today, ERP continues to grow (See Appendix B). Though more functions and processes are available (See Appendix C), the core element remains the same - the integration of an organization's functions within one system. The only change is the ability to subcontract it out in an effort to eliminate some of the high costs of implementing ERP. Those who perform these duties are known as Application Service Providers (ASP). Under the most basic level of ASP service, a company chooses a service provider to run its applications, house and run its IT equipment and provide continuous access to the software. On the other hand, the highest level of ASP services is achieved when the ASP purchases all of the equipment, puts the company's applications on it, answers all help desk and technical support questions, and is required to make changes to the application as upgrades become available [Ref. 21]. In either case, by using ASP, a business can pay a monthly fee

and rent as opposed to buying an ERP system. This new type of management is often referred to as Enterprise Resource Management (ERM).

Another option available for smaller business (revenues between \$200 million and \$500 million) is a "vanilla" off-the-shelf ERP program with little to no customization, known as Fast-track ERP. The disadvantage is that businesses are forced to change their process to fit the program. However, the advantage is that with fast-track ERP implementations, the costs are usually measured in thousands of dollars as opposed to millions of dollars and months instead of years [Ref. 22]. The reasons for this is that the vendors promise up-front guaranteed agreements on schedule and price.

2. Public Sector

Profit driven organizations are not alone in turning to ERP to gain efficiencies and eliminate "stove pipe" information relationships between organizational units. Since the early 1990s, state and federal government agencies have turned to ERP as a way to implement commercial management processes while updating inefficient and redundant legacy systems. Primary reasons for this shift in strategy are due to policy, shrinking budgets, and the need to perform services smarter, faster, and cheaper [Ref. 22].

Since the election of President George W. Bush in 2000, the implementation of better business practices and financial management/decision support systems within government have been top priority. In his fiscal year 2002 Management Agenda, improving financial performance through the use of better systems and business processes is one of five government-wide initiatives [Ref. 2].

However, the improvement of federal financial systems coupled with "better business practices" within government is not new. Since 1990, specific legislation fueled by General Accounting Office (GAO) reports has addressed inefficiencies in business practices and information systems. Among those are: the 1990 Chief Financial Officers (CFO) Act, the 1993 Government Performance and Results Act (GPRA), the 1994 Government Management Reform Act, the 1996 Federal Financial Management Improvement Act (FFMIA), and the 1996 Clinger-Cohen Act.

a. 1990 Chief Financial Officers (CFO) Act

The CFO Act required all federal agencies to improve financial reporting by integrating accounting systems, improving internal controls procedures, achieving compliance with federal accounting principles, and preparing auditable financial statements [Ref. 25].

b. 1993 Government Performance and Results Act (GPRA)

The thrust of GPRA was to reform the federal Government by requiring agencies to develop five-year

strategic plans. Additionally, those agencies are required to submit annual performance reports outlining their success in meeting the standards and measures outlined in their performance plans. The focus of GPRA is for agencies to analyze "how" they spent their resources not "if" they spent their resources [Ref. 25].

c. 1994 Government Management Reform Act (GMRA)

This act expanded the CFO Act requiring all 24 agencies to prepare annual auditable financial statements to the Director of Office of Management and Budgeting (OMB) [Ref. 25].

d. 1996 Federal Financial Management Improvement Act (FFMIA)

Building on the CFO Act, GPRA, and GMRA, the Federal Financial Management Improvement Act's (FFMIA) purpose is to improve federal accounting practices and enhance the Government's ability to provide more reliable, useful financial information. Specifically, it requires that financial systems of all 24 federal agencies be in compliance with Federal Accounting Standards (FAS), and the Standard General Ledger (SGL) at the transaction level [Ref. 25].

e. 1996 Clinger-Cohen Act

The Clinger-Cohen Act (CCA) created the position of Department of Defense Chief Information Officer (DOD CIO). Additionally, the act requires that the DOD CIO manage the investment in information technology assets just

as an efficient and profitable business would be operated. The acquisition, planning, and management of technology are to be treated as a "capital investment."

Though none of the aforementioned legislation specifically states that ERP is the required solution to all government information and financial system problems, the legislation created an environment ripe for a system capable of organizational and financial management while introducing better business processes.

3. Current Public Sector ERP Initiatives

With information system acquisition processes made easier by Clinger-Cohen and Washington D.C. leadership demanding improvements in government business practices, federal agencies took their first steps towards an ERP solution by the mid 1990s. Those include: the Department of Treasury (DOT), the Department of Energy (DOE) and the Department of Defense (DOD).

a. The United States Mint

Taking advantage of current federal legislation and philosophy to implement improved information systems coupled with better business practices, the United States Mint was one of the first ERP success projects within government. A bureau of the Department of Treasury, the Mint manufactures more than 29 billion circulating coins annually. Additionally, the Mint operates a large mail order business with distributors in 45 countries for 1.1 million coin collectors [Ref. 26]. Therefore, unlike other

federal agencies, the Mint generates revenue. Infested with "stand alone" legacy systems requiring tedious and inefficient integration, critical quarterly data typically arrived at decision makers 90 days after the quarter closed [Ref. 26]. Management was unable to ascertain exact figures for its coin inventory. With a new leadership in 1994 and the 1998 federal requirements for Y2K compliance, the U.S. Mint chose ERP to connect everything from review of raw materials to the planning, scheduling, inventory tracking, manufacturing, and financing of the coin-minting process.

By 1999, the Mint was prepared to improve their online retail site, an extension of the initial ERP project. The goal was to make it easier for customers to order collectable coins. The end result was real time information to include inventory, projected sales, packaging, and delivery efforts in process. With a price tag of \$40 million, the projected seven-year savings were \$80 million due to efficiencies. For fiscal year 1999, the Mint attained revenues of \$2.4 billion-a 51.9% increase over 1998's revenue of \$1.6 billion-and \$1.1 billion in profits [Ref. 27].

b. The Strategic Petroleum Reserve

A facet of the Department of Energy (DOE), the Strategic Petroleum Reserve (SPR) is the United States first line of defense against an interruption in petroleum supplies. Located in Louisiana, SPR stores over 565 million barrels of crude oil as a deterrent to oil import

cutoffs and is a key tool of United States foreign policy [Ref. 28]. Just like many organizations, the SPR's information infrastructure was comprised of multiple legacy systems unable to support the organizations mission. Common data were entered multiple times into different systems. "Instead of having one unique number for one part, we would have up to 20" [Ref. 28].

Starting in October of 1997, SPR began ERP implementation. By March of 1999, SPR went live on ERP, replacing eight mainframe computers and 15 smaller computers. The end result was completion of the project 63 days ahead of schedule and four percent under budget. By the end of 2000, SPR reported a 47 % return on its \$10 million investment and projected a savings of \$32 million in saved labor costs [Ref. 29].

c. Department of Defense

The business environment in which the Department of Defense (DOD) operated throughout the 1980s was significantly altered with the international events of 1990 to 1991. First, the fall of the Berlin Wall in 1990 signified a new era in which the Soviet Union was not the strategic foe of the United States. For the previous 45 years, all military strategy, warfare doctrine, and weapons systems were developed to face the Soviet Union in military battle. Second, the development and performance of "smart" weaponry during the 1991 Persian Gulf War exemplified to many that a large military was not essential as compared to the one of the "Reagan Era". Smart weapons were viewed as

not only cost effective but also valuable for minimizing unnecessary deaths. The 1997 Quadrennial Defense Review (QDR) and Defense Reform Initiative (DRI) presented new DOD policy designed to reflect the new direction of DOD while steering the services into becoming more "business like", gaining efficiencies that translate to cost savings.

(1) The 1997 Quadrennial Defense Review. One of the key documents in reforming the DOD for the new environment was the 1997 Quadrennial Defense Review (QDR). In addition to describing the future of international security threats facing the United States, it outlined how active duty military reductions had totaled 32% between 1989 and 1997. However, the number of personnel, specifically civil service, working within the DOD infrastructure was only reduced by 28% [Ref. 30]. To achieve additional savings while realigning infrastructure to the new military strategy outlined in the 1997 QDR, business practices within the DOD had to be reformed. This was dubbed the "Revolution in Military Affairs" [Ref. 30].

(2) The 1997 Defense Reform Initiative. Following the completion of the 1997 QDR, Secretary of Defense William Cohen chartered a study to address how the DOD must transform its business management to meet the needs of the war fighter. The end result of the study was the 1997 Defense Reform Initiative (DRI). The report emphasized how the DOD must reduce excess Cold War infrastructure to free up resources for modernization investments [Ref. 31]. Though most of the savings

identified by the DRI would be due to the Base Realignment and Closure (BRAC) process, the report also authorized numerous initiatives to reengineer business practices and to allow business managers to make the right decision at the right time with the right information.

d. Department of the Navy

In December 1997, guided by the 1997 QDR and DRI, the Department of the Navy (DON) began to develop a strategy paralleling the 1997 QDR "Revolution in Military Affairs". The intent was to create a "Revolution in Business Affairs" (RBA) [Ref. 32]. An element of the DON's "Revolution in Business Affairs" was a commitment to eliminate outdated Cold War business practices. For that, the Commercial Business Practices Working Group (CBPWG), one of the first chartered working groups by the RBA Executive Committee, was created to:

- Consolidate and prioritize current financial management initiatives and progress to serve as the foundation for future reform.
- Accelerate the introduction and use of appropriate commercial financial practices and reporting.
- Develop a strategic plan for implementing a business management process that would enable Department of the Navy (DON) decision makers to assess cost and performance.
- Establish a plan and architecture to implement reform.

In 1998, led by VADM John Lockard, Commander, Naval Air Systems Command (COMNAVAIRSYSCOM), the CBPWG was comprised of representatives of financial management organizations across the Department of the Navy (DON). Their goal was to look beyond commercial financial practices to commercial best business practices [Ref. 32]. Based on a final report submitted to the RBA Executive Committee in 1998, a decision was made that Enterprise Resource Planning (ERP) would be the leverage for business practices to change throughout the DON. An outcome of that decision was the authorization of six ERP pilot programs. However, due to funding constraints, only four pilot programs currently still exist. Those four are:

- Aviation Supply & Maintenance: maintenance planning and supply support processes sponsored by the Naval Air Systems Command (NAVAIRSYSCOM) and the Naval Supply Systems Command (NAVSUPSYSCOM).
- Acquisition Program Management: program management processes to include linkage between contracting and financial systems sponsored by the Naval Air Systems Command (NAVAIRSYSCOM).
- Navy Working Capital Fund (NWCF) Financial Management: management of the Navy Working Capital Fund within acquisition commands sponsored by Space and the Naval Warfare Systems Support Center San Diego (SSC-SD).
- Regional Maintenance: avionics and repair center processes across surface, air, and subsurface communities sponsored by the Commander in Chief Atlantic Fleet (CINCLANTFLT) and the Naval Sea Systems Command (NAVSEASYSYSCOM).

Given the limited budgets of the early 1990s coupled with legislation demanding improved business processes within the DOD, ERP was piloted to assess its capabilities to improve financial management systems and business processes within the DON. Chapter Three will discuss Space and Naval Warfare Systems Center San Diego (SSC-SD) and their road to ERP.

III. SPACE & NAVAL WARFARE SYSTEMS CENTER-SAN DIEGO (SSC-SD) AND ENTERPRISE RESOURCE PLANNING (ERP): AN OVERVIEW

A. INTRODUCTION

This chapter will provide an overview of the Space and Naval Warfare Systems Center, San Diego (SSC-SD). Specifically, the focus will be directed on their efforts in implementing ERP.

B. HISTORY OF SSC-SD

1. Organization

On June 1, 1940, the Navy established its first West Coast laboratory, the Navy Radio and Sound Laboratory (NRSL), at Point Loma, San Diego. The mission of this organization was to improve communications for ships at sea and conduct studies on two emerging technologies, radar and sonar, to determine if they had any value for the Navy [Ref. 33]. Since then, the organization has realigned, merged, and changed names 18 times to the current name of Space and Naval Warfare Systems Center San Diego (SSC-SD). (Figure 3.1)

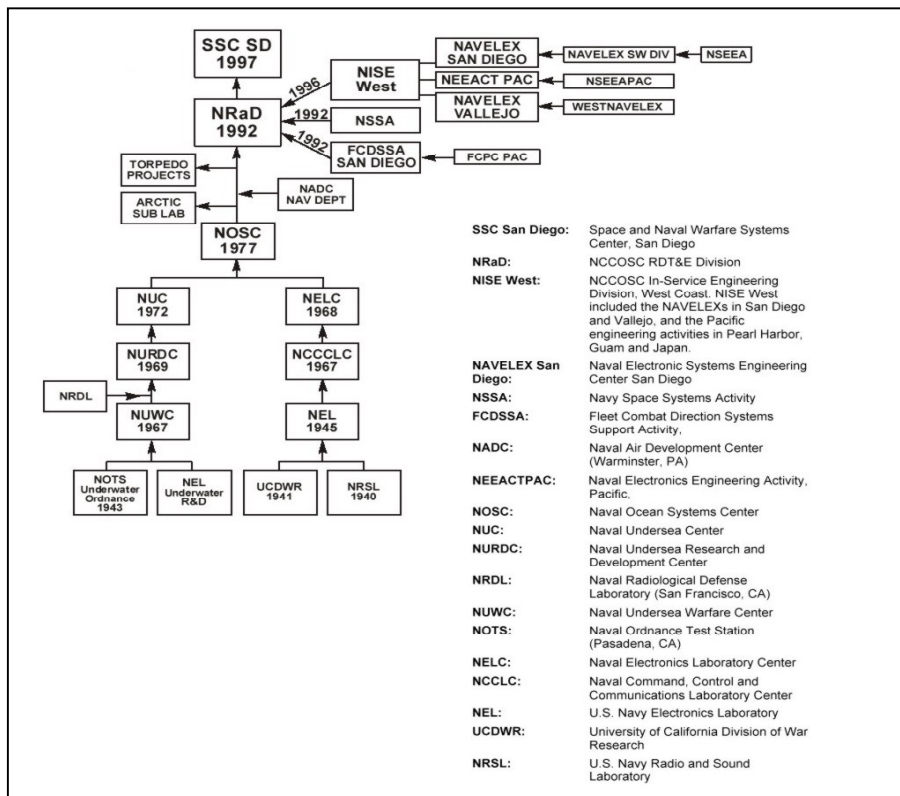

Figure 3.1. SSC-SD Evolution (From: Ref. 33)

Today, SSC-SD is one of three systems centers reporting to the Space and Naval Warfare Systems Command (SPAWARSYSCOM). Its facilities occupy more than 580 acres in four locations within San Diego, CA. A total of 3,498 personnel are employed, with the majority being scientists and engineers.

2. Products

Over time, SSC-SD's mission and strength have developed into a unique expertise across the full spectrum

of C⁴ISR (command, control, communications, computers, intelligence, surveillance, and reconnaissance). Its activities range from basic research and prototype development through systems engineering to life cycle support of fielded systems. While most of SSC-SD's work addresses Navy needs, they actively offer services for the Marine Corps, Air Force, Army, and Coast Guard. The following are leadership areas formally assigned to SSC San Diego [Ref. 34]:

- Command, control, and communication systems.
- Command, control, and communication system countermeasures.
- Ocean surveillance systems.
- Command, control, and communication modeling and analysis.
- Ocean engineering.
- Navigation systems and techniques.
- Marine mammals.
- Integration of space communication and surveillance systems

3. Resources

During the 1990s, in an effort to streamline research, development, test, and evaluation (RDT&E) infrastructure, Section 907 of the Strom Thurmond National Defense Authorization Act (NDAA) required the Secretary of Defense to consider the use of a revolving fund (e.g. Working Capital Fund) as a potential methodology for assessing costs [Ref. 35]. SSC San Diego operates under the Working Capital Fund (WCF) accounting process. Working Capital

Funded organizations operate essentially as private industry operates. They market and sell their services, build a customer base, and generate revenue. (Figure 3.2)

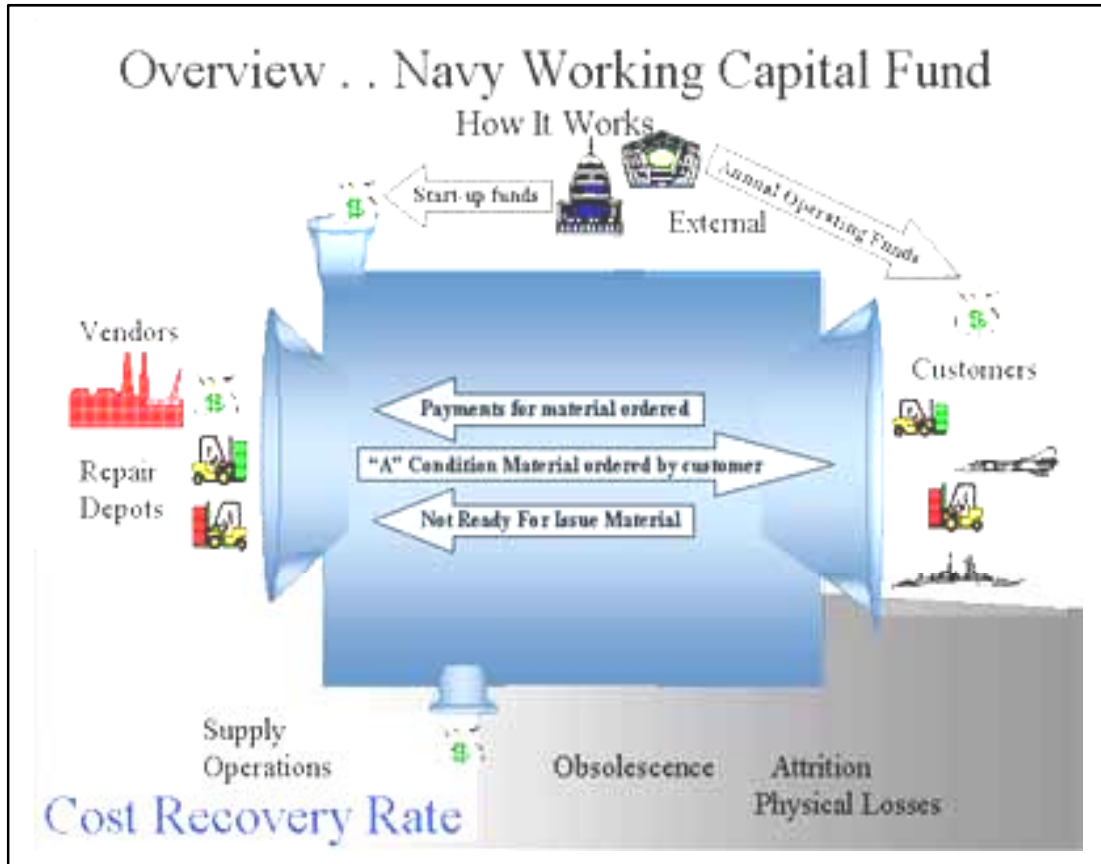

Figure 3.2. NWCF: A Graphical Overview (From: Ref. 36)

However, a WCF organization's goal is to break even vice generating a profit. This is achieved through proper planning of future workload combined with accurate cost estimates in providing their services. An overhead rate is then calculated and applied to the direct costs in providing the service or product. This additional cost must be recovered to pay for overhead to include: utilities, and maintenance.

Figures 3.3 and 3.4 are representations of SSC San Diego's funding structure and customer base for FY 2001.

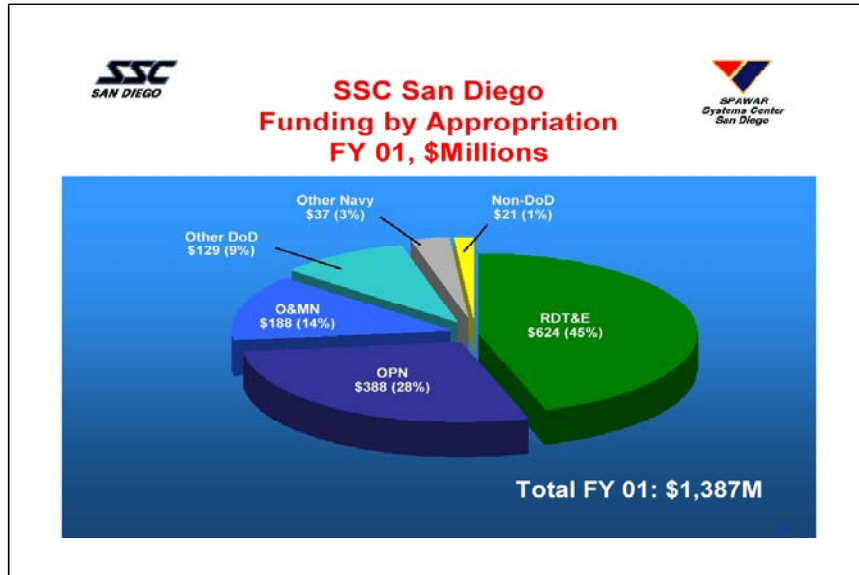

Figure 3.3. SSC San Diego FY 2001 Total Funding by Appropriation (From: Ref. 33)

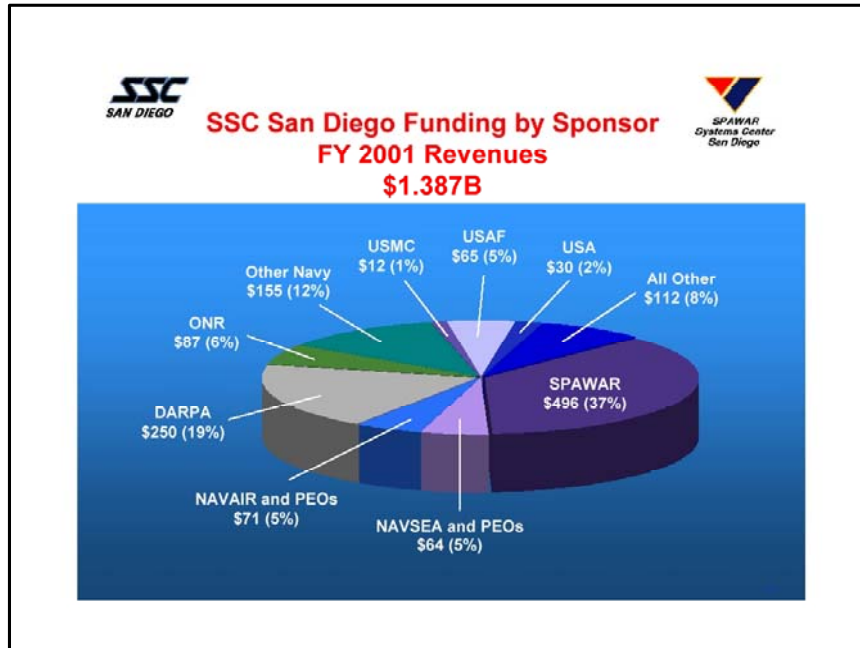

Figure 3.4. SSC San Diego Resource Base (From: Ref. 33)

C. SSC-SD AND ERP

1. ERP Pilot Selection

With the end of the Cold War, decreasing defense budgets, and the demand for improved business practices within DOD, SSC-SD was selected in 1998 as a pilot project for the use of Enterprise Resource Planning (ERP). Specifically, SSC-SD, as a Working Capital Funded (WCF) organization, was to evaluate ERP as a tool for financial management to include [Ref. 38]:

- Financial management- All financial activities including budgets, funds management, billings, payables, reporting, and employee data.
- Procurement management- all buying activities for maintenance, repair, and overhaul items, from

issuing a purchase order, receipt of goods, and processing vendor invoices.

- Asset management- Including both real property and improvements. Tracking all assets from acquisition to disposal.
- Project management- fully integrated project management systems that tie together project management tools with finance, budgeting, procurement, and asset management data.
- Strategic management- Planning and budgeting tool for both annual and long range planning. It will build upon annual budgeting and planning needs to develop a long-range orientation for SSC-SD

Their findings were, and still are, reported to the Commercial Business Practices Executive Steering Group (CBPESC) of the RBA office and used in conjunction with findings from the other pilots. Though there is overlap in ERP functions by each pilot, the goal of CBPESC is to select the right ERP solution for the entire Navy [Ref. 32].

2. Plan Development

The initial step taken by SSC-SD was the formation of an ERP project team. The project team was made up of personnel from SSC-SD functional areas to include: budget and accounting, business systems, and all of the product departments. Additionally, given how federal financial management is structured, external organizations were involved including the Defense Finance and Accounting Service (DFAS) and the Assistant Secretary of the Navy for Financial Management and Comptroller (ASN FM&C). Cross-

functional team implementation was required given the number of stakeholders involved.

The Project Cabrillo team, working in conjunction with the Gartner Group, an objective consulting firm, developed an initial business case analysis (BCA) to determine whether an ERP solution would be economically and functionally viable at SSC-SD. From March to May 1999, Gartner Group and the Project Cabrillo team conducted extensive interviews with SSC-SD business and technical units, current business process documentation, and a business functional gap analysis in developing a final recommendation.

The BCA was completed in May 1999; Figure 3.5 is an overview of the "As Is" Business Model operating at SSC-SD.

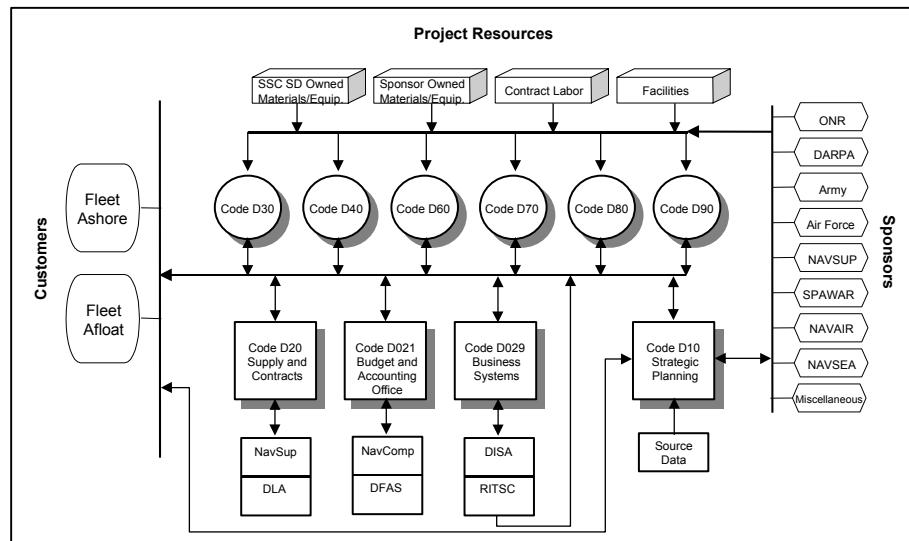

Figure 3.5. "As Is" Business Model (SSC SD) (From: Ref. 39)

Problems with the 1999 business model were:

- Technical Codes and SSC-SD general service providers function within stovepipe processes. There are no standardized tools, which results in duplicated efforts, proprietary data, and inconsistency of reporting data.
- Data are frequently unavailable and many times inconsistent and unusable throughout SSC-SD, creating shadow organizations to reconcile data for decision makers.
- Reconciling information between systems created extra work and surfaced data integrity issues.

Additionally, the ERP project team developed a "To Be" Business Model. Figure 3.6 is an overview of how SSC-San Diego will operate with the incorporation of ERP.

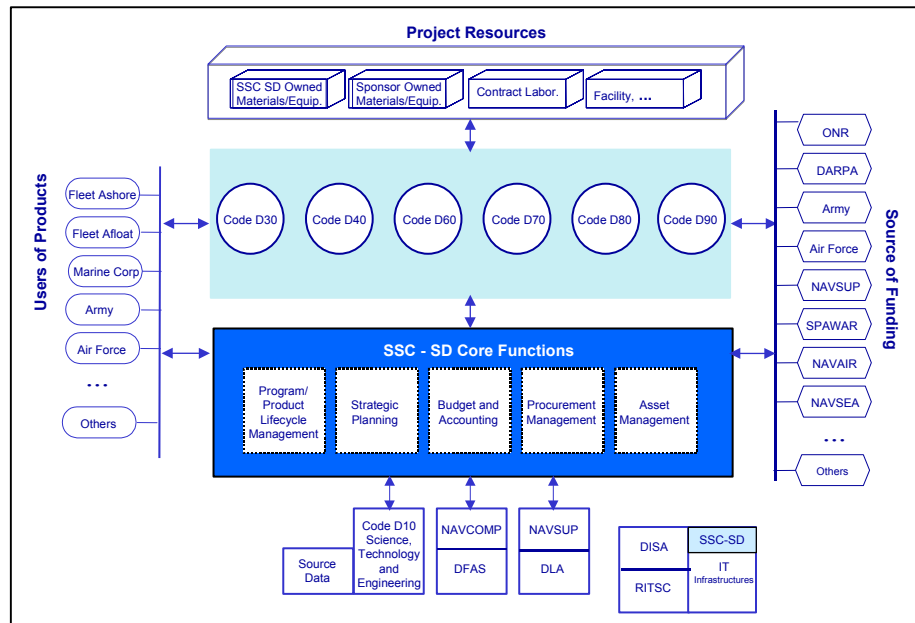

Figure 3.6. "To Be" Business Model (Project Cabrillo (From: Ref. 39)

Benefits from process improvements afforded by ERP are:

- Technical Codes and SSC-SD core functions are tightly integrated through the implementation of an enterprise business applications infrastructure allowing the availability of consistent usable data.
- Sponsor and customer interaction is performed via a "common face".
- Shadow organizations disappear because data are real time or near real time.
- Program/product information for each of the technical codes is stored in a common repository.

The final recommendation was that an ERP environment would aid SSC-SD in achieving its goals [Ref. 39]. However, the number of processes to be integrated by an ERP system would be decided by SSC-SD leadership. Implementation scale options were provided in the BCA with a full ERP implementation (i.e. five functional processes) as the recommendation from Gartner Group. (Figure 3.7)

Additional information generated from the BCA included: implementation approach, software provider assessments, risk assessment, and an initial project calendar (figure 3.8).

	Five Core Processes		Four Core Processes		Three Core Processes	
	Program/Product Lifecycle Management, Budget and Accounting, Procurement Management, Asset Management and Strategic Planning		Program/Product Lifecycle Management, Budget and Accounting, Procurement Management and Asset Management		Budget and Accounting, Procurement Management and Asset Management	
	500 Concurrent Users	250 Concurrent Users	500 Concurrent Users	250 Concurrent Users	500 Concurrent Users	250 Concurrent Users
Total Cost over 7 Years	58,800,000	44,276,000	56,510,000	42,557,000	44,441,000	33,467,000
Total Benefit over 7 Years	53,500,000	53,500,000	53,500,000	53,500,000	53,500,000	53,500,000
Net Savings/Cost over 7 Years	-5,300,000	9,224,000	-3,010,000	10,943,000	9,059,000	20,033,000

Figure 3.7. Gartner Group ERP Implementation Recommendations (From: Ref. 39)

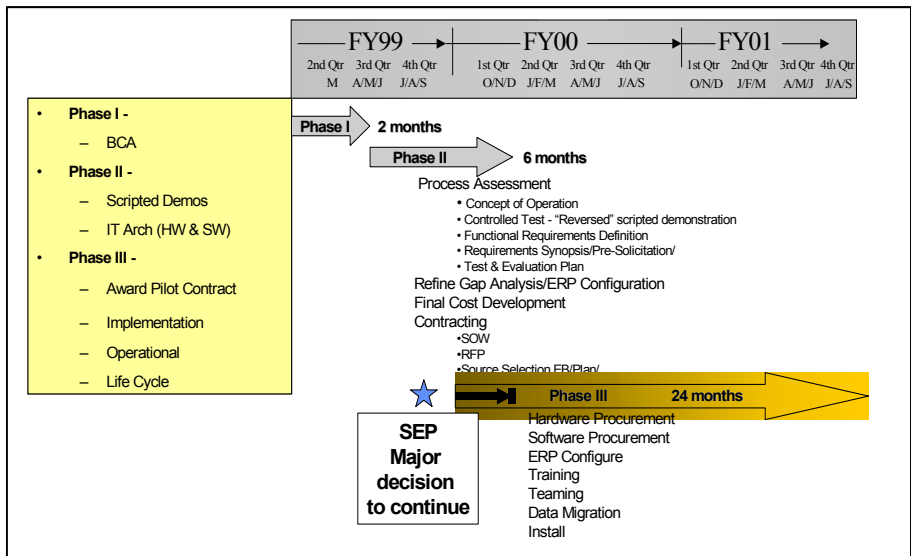

Figure 3.8. Project Cabrillo Wave One Schedule (From: Ref. 38)

3. Software Selection

As presented in Figure 3.8, Wave 1 of Project Cabrillo implementation was composed of three phases. Phase One consisted of developing the BCA. Phase Two consisted of further assessments of current "As Is" business process, demonstrations of software capability between ERP software, refinement of the functional gap analysis originally created in Phase One, final cost development, and the actual contracting for the software integrator for the pilot ERP implementation [Ref. 38].

SSC-SD selected SAP as the ERP vendor. The SAP ERP was purchased following software demonstrations by three vendors (SAP, Oracle, and PeopleSoft).

SAP's R/3 software is an integrated suite of application software modules for business processes using real time data base updates. (Figure 3.9) It is used in a client server environment in which a host computer holds data files and client computers bring the files out of the host to use them, and then return them to the host when they are done [Ref. 38].

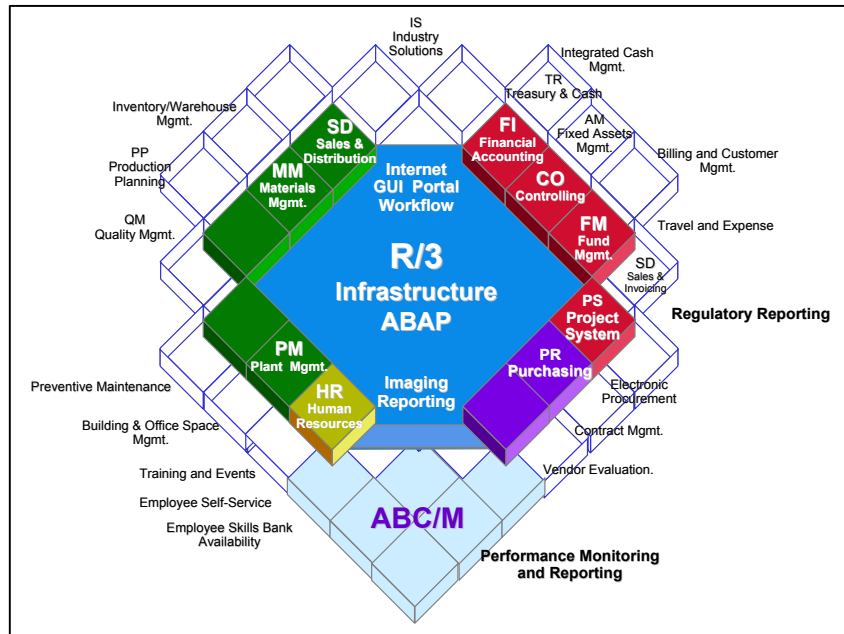

Figure 3.9. SAP R/3 Architecture (From: Ref. 38)

In addition to the SAP software, the selection of a Systems Integrator (SI) was a critical objective in Wave One. In June 2000, Price Waterhouse Coopers was selected as the prime SI contractor for Project Cabrillo [Ref. 75]. The goal for SSC-SD was to develop a long term partnering relationship with Price Waterhouse Coopers in order to attain the best value from the enterprise solution [Ref. 38]. Price Waterhouse Coopers had the experience in implementing commercial-off-the-shelf (COTS) ERP software in organizations similar to SSC-SD to include: Department of Education, Department of Treasury, and the United States Customs Office. This included implementing business process reengineering, a training strategy, and system hardware and software administration.

4. Go Live

After the selection of Price Waterhouse Coopers as the primary SI for Project Cabrillo, Phase Two concluded in June 2000. The plan for Phase Three was the implementation of business processes within the ERP solution. This included the interfacing of legacy applications. Additionally, the Assistant Secretary of the Navy for Financial Management & Comptroller's Office of Financial Management Operations (FMO) was to review the system, ensuring that requirements of the Chief Financial Officers (CFO) Act were met in providing auditable information to the transaction level. What made Phase Three critical was that legacy systems were to be retired requiring the transition to ERP at SSC-SD. Therefore, the training of users would be just as critical. Phase Three was scheduled to take from 18 to 24 months.

In the original BCA, savings generated by ERP at SSC-SD were based on relief from certain Navy and/or regulatory mandates, specifically the use of the Defense Finance and Accounting Service's (DFAS) Defense Industrial Financial Management System (DIFMS) as the accounting system of record and the requirement to track "the color of money" in a process-constraining fashion [Ref. 38]. With assistance from DFAS and Naval Audit Service (NAVAUDIT), Project Cabrillo attained permission in May 2001 from FMO to suspend the use of DIFMS and "go live" was authorized [Ref. 40]. On 2 June 2001, DIFMS was secured and on 28 June 2001, SSC-SD "went live" on ERP.

With system implementation and "go live" behind them, SSC-SD focused on adjusting to the new ERP environment. As with many ERP implementations, "productivity dip" is common after the transition due to the new business processes introduced and the time required for organizations to acquaint. Additionally, as required by Undersecretary of Defense (Comptroller) (USD(C)), focus would also shift to preparations for an independent Chief Financial Officers (CFO) Act and Financial Management Modernization Program requirements assessment in January 2002.

In January 2002, Booz Allen Hamilton, an independent consulting firm, was contracted by FMO to assess Project Cabrillo. Utilizing the requirements of the *Guide to Federal Requirements for Financial Management Systems* (a.k.a. The Blue Book), Business Process Reengineering (BPR) assessments, employee interviews, SSC-SD's key performance indicators (KPIs), they observed and assessed SSC-SD's use of ERP. The goal of the assessment was to ensure that the system met all legislative and Department of Defense (DOD) requirements for financial management systems, including feeder systems, prior to deployment or full rate production [Ref. 41]. Based on the assessment of Booz Allen Hamilton, Project Cabrillo met all requirements and is CFO Act compliant authorizing the SAP software to be utilized throughout the DOD.

Since the initial BCA, SSC-SD has reengineered many of its business processes, resulting in a more efficient system that offers more than just the automation of manual

processes. Cost center managers are provided real time information that was not available under the old system. The information is accurate, and the users have the capability to drill down to all of the transactions that make up their management information reports.

The SSC-SD ERP system replaced a total of 59 legacy systems. It has single source entry, and eliminates interfaces with other functional systems at the San Diego activity due to integration. Additionally, the system has automated interfaces with DFAS. In an interview with Mr. John Gorman, Assistant Comptroller SSC-SD, it was learned that the ERP system is on track to meet Net Benefits for FY 2002 of \$7,375,561 as outlined in the March 2001 ten year economic analysis (Appendix D and E)

IV. LESSONS FROM INDUSTRY

A. INTRODUCTION

As outlined in Chapter II, although there are business process and system integration benefits to be gained, an ERP implementation project can be complex and expensive. This chapter will outline, "lessons learned" from numerous private sector ERP projects. By organizing these findings into advantages, disadvantages, and lessons learned, commonalities of successful implementation projects can be identified.

B. ERP ADVANTAGES

1. Elimination Of Costly, Inflexible Legacy Systems

Prior to the selection of an ERP system, most organizations operate on older "stand-alone" systems. Because of the lack of integration between these systems, same data are entered multiple times into multiple systems. Many organizations try to integrate these "stand-alone" systems using local patches that are created by local systems adding to the inventory of systems and creating the need for system integration personnel. The end result is excess work, higher probabilities of data entry errors, and excessive cost. Therefore, elimination of these costly "stand-alone" systems for an ERP system provides data integration while eliminating excessive work and the reduction of errors.

2. Improvement of Current Business Processes

ERP is more than software. It requires organizations to improve and structure their processes around the system. Though some firms "customize" the software to fit their processes, this is discouraged [Ref. 22]. ERP software, for example SAP, incorporates "best of practice" business processes. The result is a template of processes within the software in which an organization structures itself. These templates are based on detailed industry-wide research and experiences from prior custom ERP projects of successful companies [Ref. 22]

3. Improved Decision-Making Capabilities

An ERP system collects data from the entire organization and integrates them into one database available for all to access. This central database eliminates the need for system integrators to collect and customize information in the required format for business decisions. Decision makers have information available from all operations, local and worldwide, at their desktops [Ref. 42]. Additionally, organization's departmental information is processed in real-time. This allows immediate access to timely information resulting in better and more responsive decision-making.

4. Reduced Paper Documents

Providing on-line formats reduces paper documents. According to a study conducted by Environmental Energy Technologies Division at Lawrence Berkeley National

Laboratory, the average cost to store and research a typical paper record is .22 cents per page annually, using the standard of 150 pages per filing inch [Ref. 43].

5. Greater Accuracy Of Information With Detailed Content

As the phrase "Garbage in, garbage out!" suggests, an information technology system is only as good as the information that is input. With ERP, data are entered once. This reduces data entry error and redundancy of information in a multiple system environment. All transactions are executed within the system allowing accurate reporting, while meeting auditor satisfaction [Ref. 42]

6. Improved Cost Control

Organizations can experience improved cost control over their operations with an ERP system. The data are real time. The system has no grace period or buffers. Transactions are executed immediately enhancing operations. Management knows the financial condition of their organization allowing decisions to be made to minimize cost. Manufacturing problems can be eliminated before they surface (e.g. inventory inaccuracy).

7. Decrease In Customer Response Time

Organizations can respond quicker to the needs of their customers, given that information has already been collected and stored in a central database. Additionally, ERP systems can be linked to customers and suppliers (i.e.

Business to Business or B2B) through the Internet and/or Intranet. Therefore, buyers and suppliers can share data and track the real time status of services without interruption.

8. Decreased Cycle Time Of Payments

The integrated system that ERP provides enables timely and accurate billing, which leads to faster receipt of payment. Invoices are processed as inventory is shipped resulting in the customer receiving the bill in a timely manner. The sooner the customer receives the bill, the faster it can be processed for payment. An ERP system will also maintain accurate aged accounts receivables and generate standard reports for those customers who are late in payment. Late payment customer data can then be swiftly sent to the collection department for further processing. Additionally, past payment information can be tracked, providing the company with pertinent decision-making information when dealing with customers in the future e.g. interest rate determination, loan qualification, and overall risk of doing business.

9. Improved International Operations

An ERP system can support a variety of tax structures, invoicing schemes, multiple currencies, multiple period accounting and languages. This is valuable for organizations with international divisions whose customer and supplier bases have expanded beyond national borderlines.

10. ERP Provides Functionality to Interact With Other Modules

Since the goal of an ERP system is to integrate entire operations (e.g. production, finance, sales, materials) of an organization, it is designed to interact seamlessly with all modules within the ERP system, e.g. accounts receivable, sales order, fixed asset management, inventory control, etc. [Ref. 44].

11. Single-Vendor Approach

Multiple vendor systems (e.g. Oracle, local programs, etc.) in an organization can reduce flexibility and increase maintenance costs. With one system, ERP, running all of the business processes, future upgrades and improvements will be easier and cheaper to install while eliminating the need to integrate with older legacy systems [Ref. 45].

12. Web Based Applications

ERP systems have increasingly been designed to effectively utilize the Internet to apply many of the ERP system solutions. Web interfaces offer easy access to a wide range of information [Ref. 46].

B. ERP DISADVANTAGES

1. Implementation Time

Real ERP transformation usually runs between one to three years [Ref. 47]. This includes developing the initial business case analysis (BCA) to fully implementing

new software, new processes, and the elimination of the old systems. Many organizations cannot afford the time, personnel, and capital for such an investment. Additionally, there is no guarantee of when the transformation is complete.

2. Expense Of Implementation

ERP system implementations have been known to break budgets. Some examples are [Ref. 48]:

- W.W. Grainger Inc.: Grainger spent at least \$9 million on SAP software and services in 1998 and last year, but the ERP system over counted warehouse inventory and had routine crashes. During the worst six months, Grainger lost \$19 million in sales and \$23 million in profits.
- Tri Valley Growers: A giant agricultural co-operative, Tri Valley bought at least \$6 million worth of ERP software and services from Oracle in 1996. None of the software worked as promised; some of it could not even be installed on Tri Valley's hard drives. Tri Valley filed a \$20 million dollar lawsuit and stopped-paying Oracle. Oracle counter sued for breach of contract. In the end Tri Valley filed for bankruptcy protection and Oracle denied all claims.

Most implementations run into the tens of millions of dollars and have, on average, gone over budget by as much as 25 percent [Ref. 49]. ERP professionals consider the following areas most likely to contribute to budget overruns [Ref. 47].

a. Training

Training is the unanimous choice of experienced ERP implementers as the most underestimated budget item. The reason for this is that the workers not only learn how to use a new software interface, but must also learn a new set of processes.

b. Integration, Testing, and Maintenance

Linking other software applications with the ERP system, as well as ERP customization requires integration, testing, and maintenance. These costs tend to be higher than anticipated.

c. Data Conversion

It is difficult to move "clean" (i.e. accurate) data from a legacy system into an ERP system. However, it is even more difficult if the information is "dirty" (i.e. inaccurate), which in most cases is found to be true in businesses with assorted legacy systems tracking same data. It is during these cases of dirty data that the data conversion phase of an ERP project increases in time and cost.

d. Data Analysis

When an ERP program is forced to produce several reports in a variety of forms, it often leads to the need for custom programming. Additionally, when combining internal and external data and refreshing them on a daily

basis, often without a proper data warehouse, a burden can be put on the system causing slow downs or lock up. All of these problems, if not planned for early, can lead to unanticipated custom programming and additional upgrades, which contribute to increases in costs.

e. Consultants

When companies fail to plan for disengagement from consultants, the fees can pile up. For example, Gallery Office Solutions, one of the world's leading office technologies companies, experienced a \$25 million loss as a result of their ERP implementation effort. Of the loss, only ten percent was attributed to software cost, the remainder was in consulting fees [Ref. 50].

f. Replacing The Best And Brightest

In order to provide the greatest probability of ERP implementation and operation success, companies attempt to attain the best people in the business. In an effort to secure these personnel, consulting firms and companies will offer lucrative salaries and bonuses to persuade ERP experts to leave their current jobs. The end result is that the knowledge leaves with the expert and that person often will be hired back as a consultant, at a higher fee, to complete or maintain the system he or she originally started.

g. Implementation Teams Can Never Stop

A common mistake made after implementing an ERP system is dissolving the integration/project teams and

everyone going back to their old job. Documentation of the processes, training of personnel, and the implementation of software upgrades easily justify maintaining the implementation team. The problem is that each team member knows more about the processes than their parent departments. The organization would benefit more with the teams continuing. However, the barriers to achieving this are often that the original team members' departments cannot afford to lose personnel for long periods of time and need their personnel back. Additionally, those with successful ERP implementation experience become a very valuable asset to organizations outside that are preparing to implement an ERP program and are often lured away from their current organizations.

h. Waiting for Return of Investment (ROI)

Most companies that implement ERP expect immediate results from their effort starting with the first day of operation. Usually, this is not the case. The reason for this is it usually takes some time after initial operation for ROI visibility (i.e. the users have fully adapted to the changes and are using the ERP system effectively). It is the impediment of full acceptance that leads to a delayed ROI.

i. Post ERP Depression

In a recent survey conducted by The Conference Board on *ERP Trends*, 75% percent of the responding organizations experienced a moderate to severe productivity dip after ERP implementation. Although one-fourth of the

companies surveyed had dips lasting up to one year, most dips generally lasted less than six months. The most common reason for productivity dips is difficulties that employers experienced in adapting to the change in processes.

3. Risk Of Using One Vendor

These risks include:

- Slow or no product development. The vendor knows that the customer cannot operate without him. Therefore, a perverse incentive exists to delay or slow down implementation.
- Vendor may go out of business. So far, no ERP vendors have gone out of business. However, if a software vendor with a unique software system were to go out of business, the buyer could be stuck with using an outdated system or buying a completely new one. In either case the results could be very costly.
- Lack of competition in ERP Market. This allows the vendor to set monopolistic prices. Which are higher than competitive markets.
- Vendor dependency. Once a contractor is selected and implementation is started, the buyer is often at the mercy of the vendor. Any changes from the original plan often result in huge price tags and schedule slips. Some examples are as follows:
 - Hershey Foods Corporation: The price tag on the doomed Hershey's project, for instance, totaled \$112 million, according to the company and press reports [Ref. 51]. However, because of schedule slips Hershey lost 12 percent in revenue in the third quarter, their biggest quarter, during Halloween and Christmas.

- Fox Meyer Corporation: Once a \$5 billion drug Distribution Company and once the nations fourth largest distributor of pharmaceuticals, budgeted \$35 million for an ERP implementation. However, after spending over 100 million dollars on the program the company was forced to file for bankruptcy in 1996 [Ref. 48].
- Dell: Dell Computer actually scrapped its SAP implementation in January 1997, after plowing over \$30 million into it [Ref. 52]. The company estimated it would cost a total of \$150 million to complete, and even then Dell was not sure if the system would be able to support Dell's expected sales.

4. Security Issues

Security is a primary concern for ERP implementation and operation. Most businesses today maintain their "competitive advantage" behind the firewall of their systems. In the case of ERP, this information is vulnerable to exposure due to the Internet or ERP system integrations with suppliers and customers. Critical business information (e.g., pricing models, overhead cost data, etc.) could be lost, resulting in devastation for a business.

C. LESSONS LEARNED FROM THE PRIVATE SECTOR:

Now that the Department of the Navy (DON) has invested in the four ERP pilot projects, lessons from corporate sector organizations should provide a foundation in preparing for their proliferation throughout DON and DOD. The following section outlines 13 areas that require planning, management, and proper execution when

implementing and operating an ERP system. These "lessons learned" are based on research of private organizations that have implemented ERP and the common success and failure areas of implementation experienced.

1. Business Case Analysis (BCA)

Lance Travis, Vice President of AMR Research (Boston, Massachusetts), suggests first and foremost "all IT projects should be examined to be sure they solve a business problem" [Ref. 53]. This is the reason why surveyed companies, that have implemented ERP, stated that the most important driver in achieving ERP success is the early and comprehensive development of a business case analysis (BCA) outlining how ERP will solve existing problems [Ref. 49]. The most successful ERP implementations resulted from companies allocating up to 10 percent of the project budget developing a BCA with quantifiable goals [Ref. 54].

In developing an effective BCA, the company must examine their organization's current processes (i.e., "As Is"); develop sound business assumptions, and outline an achievable and beneficial "To Be" environment after an ERP implementation. Then, they must develop strategies that support the "To Be" goal with metrics to measure success. A metric is a verifiable measure, stated in either quantitative terms (e.g., 95 percent inventory accuracy), or in qualitative terms (e.g., we are providing above average service according to customer evaluations) [Ref. 55]. A quality BCA must also identify the risks,

tradeoffs, and costs associated with increased benefits. This detailed analysis requires involvement of the senior leadership.

The active role of leadership in the business case development often leads to "buy-in" by middle management. Middle-management leadership is a must for both a successful ERP implementation and employee satisfaction. Additionally, the overarching BCA project team must communicate with individual project subdivisions teams (process development, software selection, and design) during the BCA development. If not, the result could be an overly optimistic business case that utilizes inaccurate assumptions in generating idealistic results via ERP [Ref. 56].

Additionally, the BCA must outline that ERP efforts are not system driven but business-led. A detailed survey conducted by the Conference Board, a non-profit organization, revealed that most failed ERP implementations result from non-quantifiable business cases focused on system issues, such as replacing legacy systems and systems integration, than business process reengineering [Ref. 49]. The BCA should identify organizational strengths and weaknesses. In doing so, weaknesses can be identified and strengthened or eliminated prior to ERP implementation. Automating a problem does not fix it; it only makes it an automated problem [Ref. 54].

Consultants can be used in developing the BCA. However, caution needs to be taken to ensure they do not drive the direction of the BCA. During an interview with Doug Timmer, Enterprise ERP Programs Director for Northrop-Grumman, he suggested using a technique he referred to as "spot consults" [Ref. 76]. This is when consultants are used only when knowledge is needed. Another recommendation by Mr. Timmer is that if a consultant is required for BCA development, consider using a different consulting firm to manage the implementation.

2. Metrics

Metrics for ERP implementation and post "Go Live" operations should be consistent with how the firm delivers value to its customers and stated in meaningful terms. "It is not enough to generate data or to measure and report behavior. All well-designed, implemented, and maintained systems of metrics assist in creating self-regulating systems where little management intervention is required, and where people, responding to the metrics, act in a way that is desired by the firm" [Ref. 55]. Therefore all metrics developed should exhibit the following characteristics:

a. 5 (+ or -2) Rule

Metrics should focus only on a critical few, perhaps five, plus or minus two, areas for measurement. Since it is impossible to measure and control everything, the focus must be on what is important. The reason for this is a principle known as "chunking". Chunking is

accomplished when the author of the metrics is able to improve the reader's comprehension and ability to access and retrieve the information [Ref. 57]. Therefore, a majority of personnel involved in the project can easily recall those requirements and notify management of any problems.

b. Linked To Value

The measure used should reflect how the firm generates value and where attention should be focused for value to be generated.

c. Meaningful

Metrics must mean something to the user and must be displayed in a way that is meaningful and easy to understand. Ownership should be assigned for the success and failure of a specific metric.

d. Timely

Metrics must have the capability of being measured immediately. There is no sense having a metric that cannot be measured in a timely fashion, 90 days or less [Ref. 58]. Additionally, there should be sufficient time available to fix any issues that are creating problems. The metric should act as an early warning device. Metrics should be reviewed regularly and updated and changed if needed based on where the project is in its lifecycle.

e. *Appropriate Standards Used*

In order to be effective, metrics need to have some basis for comparison (i.e. a standard). This standard must be realistic, appropriate, and feasible. Standards can generate from internal (e.g., the companies past experiences) or external sources (e.g., industry standards).

3. *Senior Leadership Commitment*

In order to succeed in an ERP transformation, it takes a strong will by both business operations and technology leadership. One reason for this is that there is never an end to the implementation of a system when you include upgrades and improvements. Additionally, there is no assurance of business success within the market. Therefore, all leadership must support and take an active roll in their ERP implementation. Consequently, the personnel directly in charge should also have longevity with the project.

4. *Return On Investment (ROI)*

An example of ROI is the total of cost reductions plus additional revenue divided by the amount of the investment expressed in a percentage [Ref. 59]. Generally, most companies will not lift a finger, or spend a penny, until a hefty dose of analysis proves that a given investment will generate a required minimum return on investment [Ref. 60]. Therefore, ROI is the typical metric used in determining whether or not to upgrade current systems to ERP.

A common problem with ERP and ROI is that the people desiring ERP within an organization are the same tasked with formulating its ROI if implemented. This is the "fox in charge of the hen house" relationship. The end result may be attractive ROI percentages based on highly optimistic assumptions and idealistic investment costs. Therefore, use caution when employees rely solely ROI to justify buying a product [Ref. 61].

What makes the accuracy of ROI percentage questionable is the quantifying of certain benefits. Benefits fall into one of the following three categories:

- Hard Benefits: Hard benefits are directly measurable and attributable to the ERP initiative. They are often financial and have a bottom line impact (e.g. the elimination of six data entry positions).
- Soft Benefits: Soft benefits are generally measurable, but do not have bottom line impact; factors besides ERP contribute to them. (e.g. the elimination of the need for a document to be hand carried from office A to B)
- Non-quantifiable Benefits: Examples of non-quantifiable benefits include improved competitive advantage and real time access to company-wide data/information.

It is the soft and non-quantifiable benefits that make determining ROI such a problem. It takes time and it is often tough to put a true value on the soft and non-quantifiable benefits. Yet, these benefits mean the most

according to a survey by Darwin magazine. 87 percent of public sector chief executive officers (CEOs) agree that the most important piece of ROI is increased productivity followed by customer service [Ref. 58].

Additionally, another problem with ROI is the inconsistency in methods used to generate a percentage. Once again, those in charge tend to use the formula that gives them the answers they want to hear. Therefore, the following guidelines should be utilized in determining ERP ROI:

a. Create A List

Create a list of strategic business metrics that can be applied to the ROI process for all software projects.

(1) Improved operational efficiencies. Will the application reduce head count, increase productivity, or reduce the number of applications, hardware and support staffing IT?

(2) Increased customer satisfaction. Will the software reduce order cycle time?

b. Bring IT and Finance Together

Bring IT and Finance together to jointly develop a single ROI methodology for the company and then keep finance involved. Each IT project should have a finance

person assigned to track the progress of benefits during and after the project.

c. Have ROI Benefits That Are Auditable

An ROI benefit is of no use if it cannot be measured. It is this measurement that allows the metric to be evaluated effectively.

d. Soft Benefits Matter

"Soft" benefits matter, but they should be discounted heavily. Michael Head, Executive Vice President for Human Resources for Regions Bank, Birmingham, Alabama, suggests not forgetting them but to separate them from the hard benefits, discounting them by at least 50%.

e. Factor In Productivity Discounts

Productivity ROI depends on how structured the employee's time is. Ian Campbell, Vice President of Research for Nucleus Research, Wellesley, Massachusetts, suggests a discount of productivity savings from software of up to 80 percent, specifically white-collar workers. For factory and sales people, the discount may only be 10 to 20 percent.

f. Separate Proposals

It is suggested that software proposals should be separated into those that have potential for ROI and those

that are simply the cost of doing business. Some IT projects are like a leaky roof and must be fixed no matter what, regardless if there is a payback or not. Often these projects are forced to go through the same rigors that are a waste of money.

g. Ensure That ROI Benefits are Staggered

It is important to have one metric being measured at least every 90 days [Ref. 58]. This eliminates the possibility of creating metrics that cannot be measured until several years into the program after significant dollars are spent on a system that is not meeting expectations.

However, one thing that stands out in all the research was that the success of an ERP solution in maximizing ROI depends on how quickly the benefits could be reaped. For example, the Meta Group study of 63 companies found that it took eight months after new system implementation for benefits to surface. The median savings from the new ERP system from all those surveyed was \$1.6 million [Ref. 58].

5. Change Management

Replacing systems that automate the way a company conducts business is rarely easy. Complications in this process increase without employee support. A large roadblock common with all ERP implementations is the fear generated by executives and department heads due to the

perceived loss of authority or resources [Ref. 62]. Therefore, a change management team should be established, led by senior management who focus on eliminating this threat and marketing advantages of ERP for the entire organization. Studies identify that failure in change management is a result of a lack of continuous senior leadership commitment [Ref. 49]. This stems from the authority of senior management to enforce change.

Once a change management team is in place, it should track "resistance to change" within the organization. This "resistance to change" comes in three forms: argumentative (e.g., " I need more data before I am convinced the system is a good idea"), passive resistance (e.g., simply continuing to operate in the same ways), and obstructionism (e.g., promise to provide resources and then not doing so) [Ref. 63]. Understanding these three forms of resistance contribute in the development of a strategy for change and a successful marketing campaign for ERP. Also, companies are encouraged to use past experience when implementing change and stay with what has worked.

For organizations implementing major business process change, the following are six steps from the article "How to Sell Change" by Dr. Michael Hammer that are imperative for the change to succeed:

a. *Communicate! Communicate! Communicate!*

There is no such thing as over communication.

b. Rule of Fifties

Remember to apply "the rule of fifties" when dealing with employees. The first 50 times people are told something they do not hear it; the second fifty times, they do not understand it; the third fifty times they do not believe it.

c. Benefits Sell, But Features Do Not!

Stress the payoffs, from process change, not only for the company but also for the people. Additionally, present the benefits in terms the target audience will understand.

d. Make Your Pitch Distinctive And Vivid

Major change is dramatic and requires a dramatic presentation.

e. Segment Your Market

Marketers recognize that they sell to different markets, each requiring its own particular message and media. The same is true inside an organization.

f. Never, Ever Lie, Not Even A Little

Once credibility is lost, it is difficult to earn back. Therefore, tell everyone everything you know, as soon as you know it and if you do not know it, do not be afraid to say so.

Remember, effective change management is a continuous process in which strategies are required to incorporate all employees affected throughout the implementation and use of an ERP system. After a multi-million dollar ERP implementation, Charlie Lacefield, former vice president and executive director of business and processes and IT at Dow Corning Corporation stated: " If people are going to need to adapt to new ways of doing their jobs in order for your integration project to work, not only are you going to have to train them, but you'll also have to hold their hands. You'll have to keep reminding people that they're part of a big team. The more you give, the more you get back. And the cost to do it right is not incidental." [Ref. 63]

6. Productivity Dip

All new processes require a period of time for the organization to learn and operate at the most efficient level. During this period, organizational productivity drops. In a survey of 64 Fortune 500 companies, 25 percent admitted that they suffered a drop in performance when their ERP system went live [Ref. 47]. The "steepness" of this learning curve depends on the effectiveness of change management within an organization. In addition to effective change management, the following are common elements of organizations that minimized productivity dips (i.e. less than six months) after ERP "go live":

a. Use Of Pilot Systems Or "Sandboxes"

A sandbox is a practice system allowing new users a chance to experience all ERP functions without impact on real-time business critical data.

b. "Superuser" Involvement

A Superuser is a member of the organization that understands all business processes associated with the organization and understands how ERP integrates and automates those processes. They are the "ambassadors" of ERP to the work force capable of explaining ERP capabilities in non-technical language.

c. Excellent Project Execution

This is achieved through adequate planning. This plan is developed during the conduct of Business Case Analysis (BCA).

d. Continuous Involvement Of Senior Leadership

Leadership not only has to be in the initial stages but throughout the project's development implementation and support. Continuous involvement of senior leadership has been a common trait of all successful ERP system implementations [Ref. 47].

7. Personnel Recruitment, Teambuilding, and Retention

In establishing teams for the implementation of an ERP system, the first step is to select quality people. They

must be willing to work long hours and have good people skills. The selection process should be done both inside and outside the company. Incentives, advancement opportunities or compensation packages, should be utilized in attracting quality personnel. Structure those incentives to be awarded in conjunction with implementation milestones e.g., BCA development, operational test, actual "go live", or dates after "go live". This increases the chance of maintaining the teams during implementation and post "go live".

In addition to creating a strong and viable project team, companies need to ensure that the project team is given the proper resources and authority to function. Dean Teligia, a partner with Accenture, a New York based consulting firm, stated: "First, the group has to have the right muscle behind it so that when it makes a decision, they can actually turn it into actions. Second, the members must have the ability to go in pretty ruthlessly and ask how each application is really contributing to the value of the company. Members also must be empowered and have top-level sponsorship that allows them to make tough decisions about applications." [Ref. 53]

Finally, it is essential that everyone that has a stake in the project be involved. These stakeholders typically include employees, project partners, customers, shareholders, vendors, partner companies, and executives [Ref. 54]. Without a collaborative perspective, the

project managers may find disgruntled employees standing in the way of a project's success [Ref. 64].

8. Document

It is important to document everything that is done throughout the entire lifecycle of the system. This helps to ensure compliance with the business case analysis (BCA) for measurement and provide background for any new employees in the software support section.

9. Data Integration

Data integration is when two applications built by two different developers exchange information [Ref. 65]. This process usually involves four steps: extraction, transport, transmission and loading. During this phase of an ERP implementation, companies must know that it takes more than a software installation to integrate data successfully and cost-efficiently. In fact, data integration is not necessarily an isolated project; it has a ripple effect across the entire system, often creating new applications. Ross Altman, a research director in Gartner Group Inc. warns, "Most people think it's a matter of stitching together databases. And then those stitches end up becoming mission-critical." [Ref. 65] In an effort to mitigate the risks and costs of data integration David Pearson in his article "The hidden costs of integration" suggest the following:

a. Business Objectives

A very thorough understanding of the whole information flow from legacy systems to the ERP system is critical as a starting point. Additionally, organizations must look at future integrations, two and three years down the road.

b. Weak Project Specifications Will Blow More Than Just The Budget

Nail down specifics on data sources and target, including what needs to be moved and how it will be used-or else pay more later, when doing the data mapping that should have been done upfront.

c. Most Data Are "Dirtier" Than One Might Expect

Cleansing data of redundancies and irrelevancies so they can be moved more efficiently from a source system to a target system is time-consuming and costly, but in the long run it is well worth it. Therefore, plan for and take the time to do it properly at the beginning.

d. Once Is Never Enough

It pays to take a snap shot of all data to be transferred and hang onto it for the duration of the integration project. Do this throughout the integration.

e. Take Charge Of Project Management

Do not let the consultants drive the train! The senior leadership and its implementation teams need to be in charge.

f. Monitor Transmissions To Avoid Fatal Bottlenecks

Ensure that the system does not rely heavily on a certain time of day/week/month to pass and receive data. Additionally, be careful of key dates in which your organizations tend to use the system more frequently e.g. paydays, audits, virus scans. No matter how great and efficient a system is, if backlogged, benefits are lost.

g. Do Not Forget Training and Support

It is important to remember that ERP is just a tool. Tools that people do not know how to use can be just as useless as having no tools at all. Continual training is imperative. (Carlo, 2002)

10. Costs

An ERP system cost, and its rate of escalation, is the top negative perception by organizations that debate an ERP solution to their integration requirements. Beyond the cost of the actual software, licensing costs represent only seventeen percent of ERP Total Ownership Cost (TOC). The remaining costs are split between related hardware upgrades (14 percent), internal staff costs (23 percent) and professional services (46 percent). The result is a staggering average price tag of \$7,870 per user for small

firms (less than \$200 million in revenue) and \$2,304 per user for large organizations (over \$5 billion in revenue) [Ref. 66]. On average, ERP implementation costs have accrued at 25 percent over initial budget estimations [Ref. 41]. Additionally, companies underestimate post "Go Live" support costs by an average of 20 percent of the original project budget. The following are suggested ways to avoid cost escalation problems:

a. *Eliminate Inefficient Legacy Systems*

"Cost cutting generally starts with low hanging fruit, i.e. costly inefficiencies that are easy to fix. However, low hanging fruit has a tendency to grow back and sometimes the only solution is to cut down the tree and start over." [Ref. 67] The same is true for IT investments. The tendency is to keep adding software and paying the additional cost of integrating it with the other legacy systems in order to not lose the data. Serious cost analysis must be conducted to determine whether to pay now (entire new system) or later (future data integration issues). Additionally, the elimination of legacy systems provides an opportunity to reengineer current business practices, which tend to lead to even greater cost savings in the long run.

b. *Buy Commercial-Off-The-Shelf (COTS)*

In an effort to eliminate high costs, companies should choose a "vanilla" version of ERP. By buying "vanilla", an organization will minimize customization, but will have to restructure their business processes to the

software [Ref. 22]. However, this is a key benefit in implementing an ERP system. All ERP vendors currently market generic, off-the-shelf, industry-specific templates. Based on current best business processes, these templates are designed to maximize efficiency and minimize customization.

c. Know The Contract

Chief Financial Officer (CFO) Lee Wilbur of Jackson Laboratory in Ben Harbor, Maine gave a great example of how contract formulation makes a significant difference in price and services received for an ERP software implementation. Wilbur received a bid from a contractor to implement an ERP system that was open-ended for \$7.8 million for the work on a time-and materials basis. However, when Wilbur asked the contractor to change it to a fixed fee, the contractor replied two days later with a quote of \$19.9 million [Ref. 68]. This exemplifies that system integrators (SI) working on an open-ended, time-and-materials basis rather than for a fixed fee, have an incentive to often quote low on a project in hopes of seeing the work grow as the project proceeds.

d. Time Is Money

Faster ERP system deployment means faster returns, lower risk, and lower costs. Therefore, implementing a system within one business unit vice the entire corporation initially may be the better choice.

e. Focus More On Value And Not Costs

The current trend in business is to focus more on the denominator of ROI (the costs) and less on the numerator (the benefits). "As long as you let the general managers focus on IT costs rather than on the relationship between costs and benefits, you will lose the organizational survival game. Your costs will always be too high. Investment levels must be set to optimize value—that's the game you want to play." [Ref. 69]

f. Money Talks, Use Incentives

Ken Martin, senior consultant for Technology Solutions Co, a Chicago based consulting firm, recommends that his clients use achievement bonuses for individuals. He states that "Promising the implementation team something like a \$5,000 bonus if the project hits its milestone helps ensure that everybody remains focused and doesn't resent the long hours such projects usually require." [Ref. 62]

g. Avoid "Big Bang" Approach, Release In A Series

The "big bang" approach is a very high-risk venture and calls for a large amount of resources. A better way to implement a large program is to arrange the program as a series of releases that gradually add functional modules in manageable increments [Ref. 62]. This is why most companies prefer to implement ERP as pilot projects. Pilot projects use a smaller department or division within an organization making them manageable.

These smaller versions allow for the mistakes to be fixed earlier and at a much smaller cost, mitigating some of the risks involved. Additionally, the successes can help eliminate some of the fears of the new system throughout the organization and serve as a selling point when planning for full enterprise implementation.

h. Funding Of Major Functionality Additions And Major Release Upgrades Should Be Treated As Funded Capital Projects

Additions and upgrades should be business-driven and justified, at least partially, based on measurable value to the business. The other consideration should be whether or not the ERP vendor plans to continue supporting the prior version of software and/or if the additions are needed to operate effectively.

i. Centralize Help Desk

Seventy-five percent of Fortune 1000 companies are centralizing their help desks, reducing support costs by at least 20 percent, according to Jeff Rumburg, vice president of Meta Group [Ref. 70]. This allows companies to calculate high and low periods more accurately. This leads to cost savings in staffing and helps limit effects of down time caused by maintenance and upgrades.

j. Benchmark IT Expenditures Against Competition

Routinely compare IT budgets with those of the competition. If it seems that there is a trend to spend a

lot of money on outside contractors, or hiring people to support old applications, it is probably an indication of a need to upgrade the IT system [Ref. 53].

11. Training

Training is a must with the implementation of any new system. However, this does not come without cost. It is this cost that keeps most companies from giving training the respect and resources required to be effective. The result is that if the person using the tool is improperly trained, the tool will be ineffective.

IT managers are discovering ways to make sure that a company gets the most out of every training dollar. The goal should be not only for personnel to learn new skills but also to keep them excited about their work. Consequently, good training can serve as a retention tool. From a poll of corporate Chief Information Officers (CIOs), the following are a compilation of proven suggestions for an effective information systems training plan [Ref. 71]:

a. *Set Up Feedback Loops*

This can be done by surveys or post-training interviews. Additionally, several months later the training manager checks in again with employees and managers to see if the training helped the employees improve skills and was applied to their work.

b. Train Workers "Just In Time"

Schedule training so that after training the students are ready to put their new knowledge to work. Additionally, the training should be focused on short-term skills.

c. Small Workshops With Technical Experts In Mock Working Environment

Sandboxes are experimental labs that can be established within departments or set up as special training areas. They allow employees to try various features of a system safely without affecting the "live system". Sandboxes are most effective during the period between training classes and the go-live date. Sandboxes can also be instrumental when fielding updates after going live.

12. Maintenance And Support

A study conducted by a British managed security firm, Activis (Reading, Great Britain), found that in a company with only eight firewalls and nine servers running common software - an IT manager would have to make 1,315 upgrades in the first nine months of 2001. That is an average of seven per day [Ref. 66]. This exemplifies that maintenance and support does not end with the fielding. Therefore, operational support should be treated as a necessary and routine expense. In general, investments can and should be made to improve operational efficiencies and lower the costs of supporting the ERP system long after "go live".

13. Security

Research has suggested that the earlier security is built into the software engineering process, the less security costs in the long run [Ref. 72]. Therefore, security must be a critical element of the initial BCA carried through full implementation.

D. SUMMARY

From research and interviews, there are a myriad of challenges associated with implementing an ERP system within the private sector. From failures and successes, this chapter summarized those challenges into thirteen areas that must be managed to ensure an ERP implementation success. Chapter V will analyze the implementation of ERP at SSC-SD. The focus is to identify similar lessons experienced by the Project Cabrillo team. These commonalities in ERP implementation lessons will prepare DON and DOD organizations pursuing an ERP solution.

THIS PAGE INTENTIONALLY LEFT BLANK

V. ERP IMPLEMENTATION COMPARISON: SPACE AND NAVAL WARFARE SYSTEMS CENTER SAN DIEGO (SSC-SD) AND COMMERCIAL INDUSTRY

A. INTRODUCTION

Based on ERP implementation successes and failures of private industry, Chapter Four outlined thirteen areas that must be managed and executed properly to improve chances for transformation success. Of those areas, the following chapter will highlight those critical to SSC-SD's Project Cabrillo. Additionally, unique obstacles, inherent to a government agency, will be discussed.

B. COMMONALITIES WITH PRIVATE SECTOR

1. Business Case Analysis

A business case analysis (BCA), the first product of Project Cabrillo, was updated routinely to reflect updated costs and savings. Working in conjunction with a private consulting firm, the BCA outlined: the current DON business environment, DON ERP goals, Project Cabrillo's goals, SSC-SD "As Is" business environment, SSC-SD "To Be" business environment, both a short and a long range implementation schedule, business assumptions, and an ERP vendor plan. The conclusion of the initial BCA recommended an ERP solution with a detailed analysis of system and implementation costs and the benefits that were to be attained.

Representatives of all SSC-SD business operations, both internal and external, were involved in its creation. This integrated product team (IPT) approach ensured that all aspects of SSC-SD business operations, from purchase order generation to Defense Finance and Accounting Service (DFAS) reporting, were considered when forecasting the "To Be" business environment and savings to be gained. Project Cabrillo team members contend that involving all key internal and external stakeholders coupled with a benefits realization plan was a critical element of their success [Ref. 4].

2. Commercial-Off-The-Shelf (COTS) Business Processes

To attain the efficiencies and cost savings afforded by an ERP system, reengineering business processes to fit the software is a must. Prior to ERP, many processes within SSC-SD were conducted manually, via stand-alone computers, or through the use of customized integration software. For example, purchase requests (PRs) were very paper intensive requiring multiple entries into separate systems [Ref. 74]. However, with ERP, PR generation and processing are conducted totally via ERP. Though an approval process still exists, the PR moves through the system without external systems and minimal human intervention [Ref. 74].

Incorporating best business processes with an ERP system is where savings generation begins. Many firms diminish potential savings because they over-customize the

software to meet their organizations' processes. As in the PR scenario, SSC-SD restructured their processes to maximize the effectiveness of their ERP system. Using ERP, they are now able to track a PR from its inception to the delivery of the material. There is no paper required and project managers now have real time visibility of available funds and the status of their requests [Ref. 74].

However, due to federal law and DOD requirements, there are limits in applying ERP's better business processes to all of SSC-SD's financial operations. For example, incorporating ERP processes with the financial tracking of time and attendance of SSC-SD employees is limited. This is due to the fact that the Defense Civilian Payroll System (DCPS) and the Defense Civilian Personnel Data System (DCPDS) have been designated the official systems of record for all DOD civilian personnel data [Ref. 74]. Therefore, DCPS and DCPDS had to be interfaced with ERP.

3. Project Metrics

SSC-SD's performance measurement effort involves participation by ERP process owners, ERP project team members, and key external and internal stakeholders. Additionally, it was essential to have strong executive level support via SSC-SD's Strategic Planning Committee for both ERP implementation and the performance measurement effort. Accordingly, in identifying success criteria, SSC-SD determined that ERP success could only be assessed

through its ability to support SSC-SD's business strategies.

Utilizing the Center for Naval Analyses' (CAN) Balanced Scorecard (BSC) framework, the ERP Performance Measurement Team concluded that success would be measured through a limited number of Key Performance Indicators (KPIs) and sub-level, short-term, process-related KPIs. The end result was a balanced set of measures extending from the corporate strategy focusing on three specific areas: Net Operating Results (NOR), Revenue, and Working Capital [Ref. 38].

The Performance Measurement Team mapped the ERP project to SSC-SD's strategic objectives; mapped existing "As-Is" metrics, developed "To-Be" metrics, developed KPIs for ERP, and refined these KPIs to nine primary KPIs and 32 sub-KPIs. Next, metric trees were developed linking KPIs to SSC-SD's strategic objectives and management levers (i.e. enabling tools such as technology or methodology to achieve critical success factor end results). Finally the KPIs were mapped to the Balanced Scorecard (BSC) [Ref. 38]. Figures 5.1 to 5.3 outline this process.

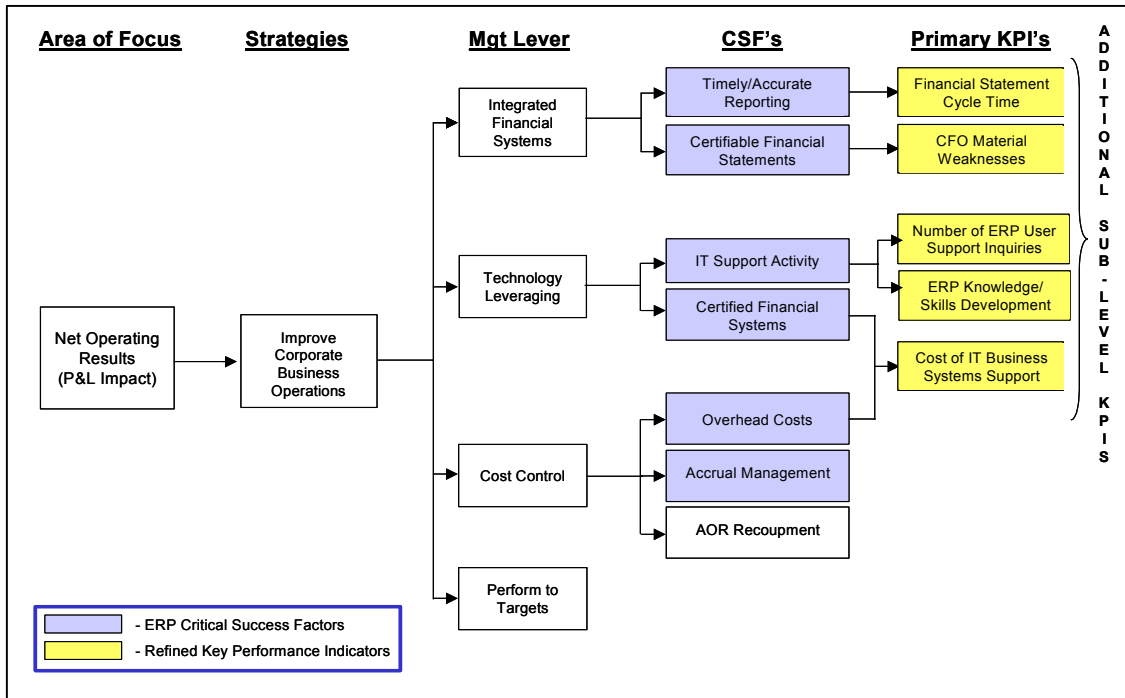

Figure 5.1. Net Operating Results Metric Tree (From: Ref. 38)

Figure 5.1 outlines the link between the focus area Net Operating Results (NOR) through SSC-SD's strategic objective "Improve Corporate Business Operations" to five of ERP's nine KPIs.

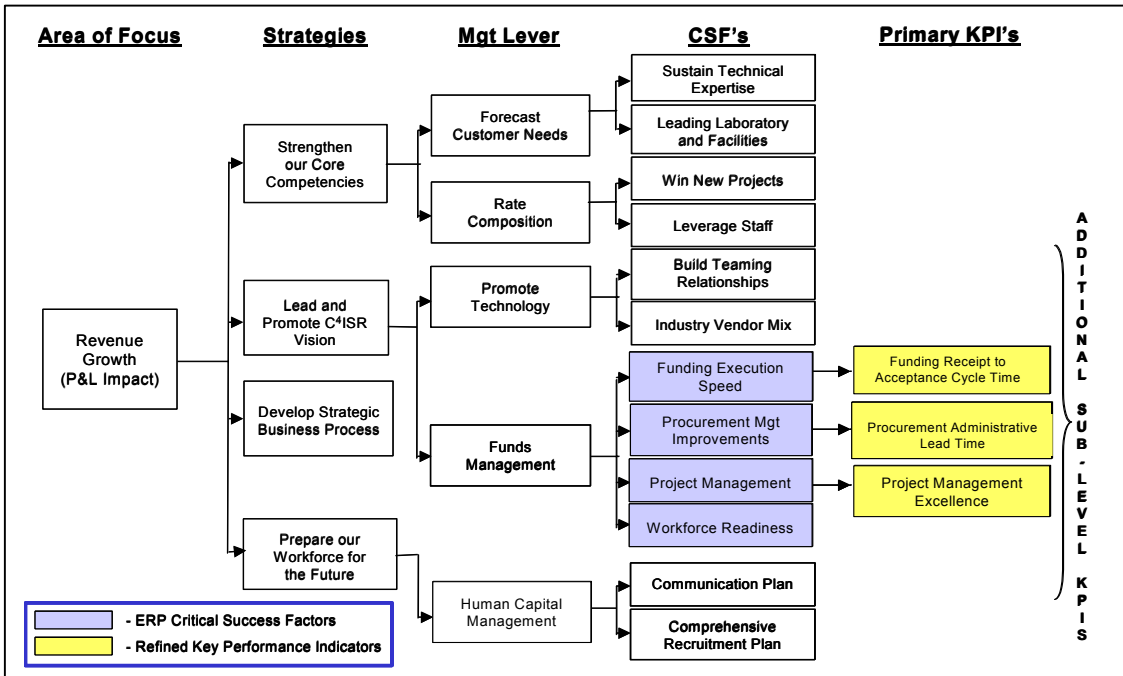

Figure 5.2. Revenue Growth Metric Tree (From: Ref. 38)

Figure 5.2 outlines the link between the focus area Revenue Growth through SSC-SD's strategic objectives "Develop Strategic Business Processes" and "Lead and Promote C⁴ISR Vision" to three of ERP's nine KPIs.

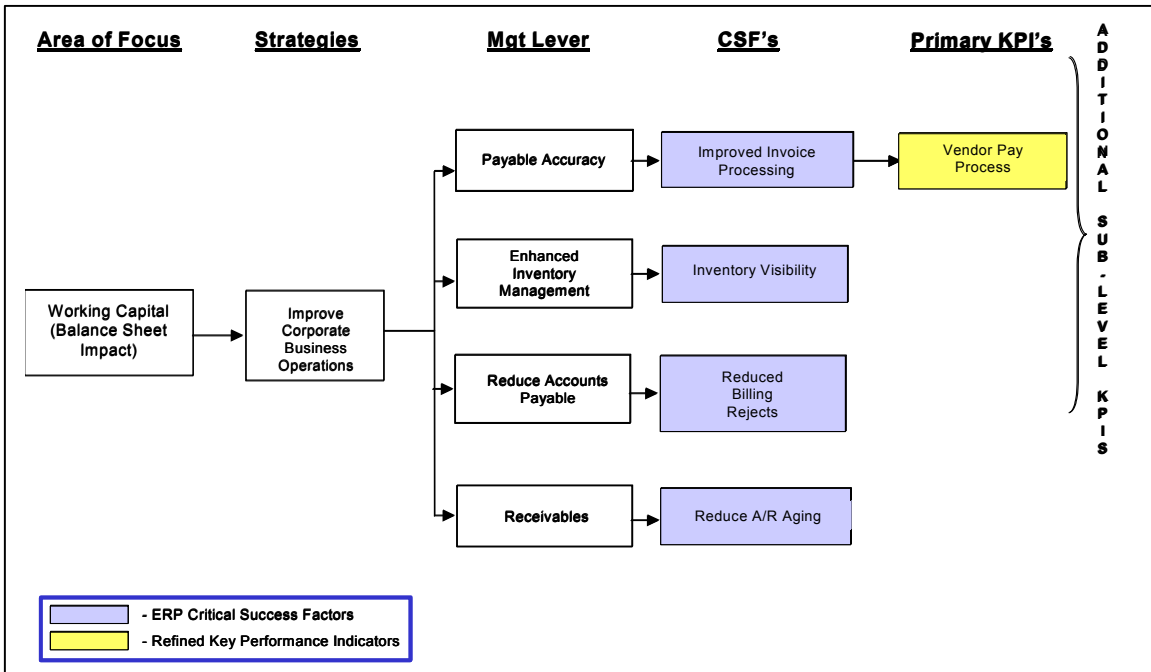

Figure 5.3. Working Capital Metric Tree (From: Ref. 38)

Figure 5.3 outlines the link between the focus area Working Capital through SSC-SD's strategic objective "Improve Corporate Business Operations" to the remaining KPI of ERP.

The BSC framework is used to describe the metrics that align with the business objectives. The goal is to balance the metrics across four areas: performance, customer, internal processes and innovation and learning (Figure 5.4). These four areas represent an integrated metrics perspective [Ref. 38].

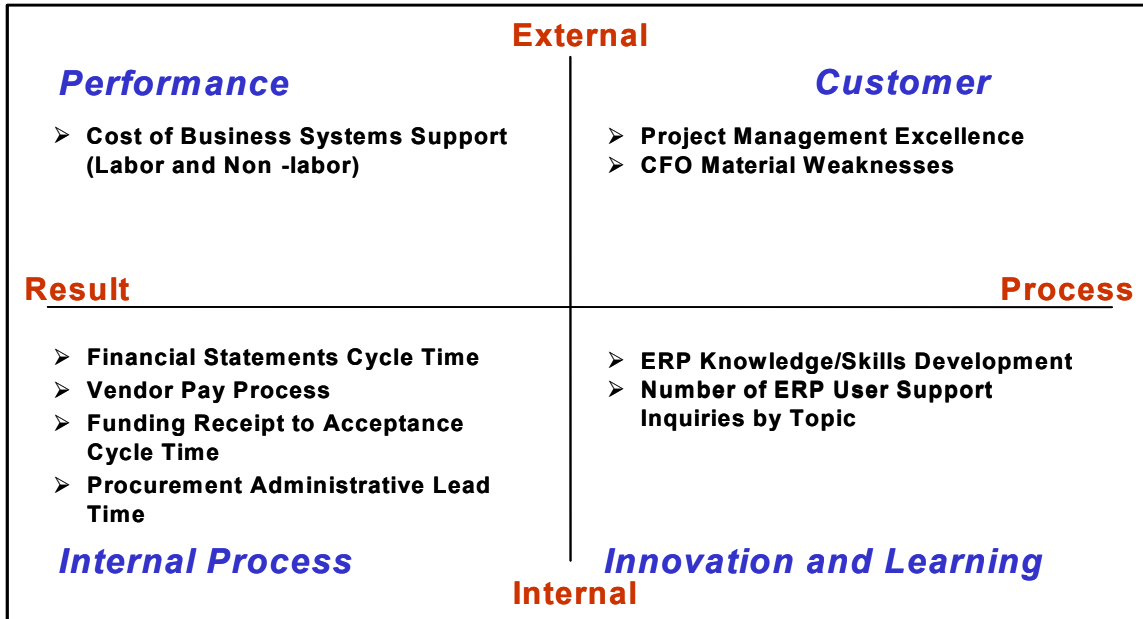

Figure 5.4. Balanced Scorecard for Cabrillo's Nine KPIs
(From: Ref. 38)

The nine primary KPIs represent SSC-SD's ERP executive level metrics. The KPIs track back to the business case and SSC-SD's strategic plan with a specific measurement technique established for each. Figure 5.5 outlines Project Cabrillo's nine KPIs. The "baseline" numbers represent actual or "As Is" metrics for each category prior to ERP implementation. The "current" numbers represent the actual status of each KPI during Project Cabrillo's Chief Financial Officer's (CFO) Act compliancy assessment in January 2002. The "goal" numbers are the optimal, or "To Be", metrics once organizational efficiency is gained in using the system. Finally, an owner for each measure is identified. That owner reports the success of the ERP implementation against these measures to senior management.

During Project Cabrillo's Chief Financial Officer's (CFO) Act compliancy assessment in January of 2002, the KPIs did not reflect all the efficiencies that SSC-SD hoped to achieve due to the system's recent implementation. (Current Column in Figure 5.5) However, the assessors from Booz Allen Hamilton and SSC-SD leadership foresee the KPI numbers improving [Ref. 74]. This improvement is forecasted to occur as the system matures and personnel adjust to process changes and apply classroom training to their actual workstation.

No	Description	Baseline	Current	Goal
1	Financial Statement Cycle Time	10 days	Not tracked	5 days
2	CFO Material Weaknesses (Annex Tab 200)	19	14	0
3	Cost of Business Systems Support (Labor and nonlabor)	\$12.6M	\$9.1M	\$4.7M
4	Funding Receipt to Acceptance Cycle Time	3 days	1 day	1 day
5	Procurement Administrative Lead Time for Simplified Acquisition	44 days	29.3 days	36 days
6	Project Management Capability (User Surveys)*	1-3	1	4-5
7	Vendor Pay Cycle Time	22	21	15
8	Number of ERP Help Desk Calls	N/A	30-60 Calls/Day	Reduce # over time
9	ERP Knowledge/Skills Development	17,200 hours/training	31,924 hours/training	38,000 hours/training
*Scale (satisfaction levels): 1 = Very low, 2 = Low, 3 = Moderate, 4 = High, 5 = Very High				

Figure 5.5. Project Cabrillo KPI Status and Goals January 2002 (From: Ref. 74)

The metrics established by SSC-SD for their ERP implementation and transition plan follow those of successful private sector ERP implementations. For executive monitoring, the number of KPIs is manageable. Also, the metrics are critical in that they specifically measure ERP's success or failure and how that success or

failure contributes to SSC-SD achieving their strategic goals. Finally, the metrics have ownership responsible for their success and failure.

4. Training

As with any organizational process change, training the organization is essential to ensure understanding and proper execution of new processes. For Project Cabrillo, training was a top priority beginning with the initial business case analysis. A Change Management Team was established early with full empowerment to address all aspects of the project. They worked across the entire Project Cabrillo Team to ensure consistent and accurate communications were reaching the organization while handling questions from the remainder of SSC-SD.

A complete and comprehensive set of training materials was developed. This included early-on classroom instruction, classroom materials, and computer based training. A team of 60 end-user trainers was recruited from across the organization to deliver classroom training "just in time" one month prior to "go live". Also, "sandboxes" (i.e. mock systems) were created for the end-users to practice the classroom instruction on actual ERP desktop workstations prior to system "go live".

Though the training preparation by the Project Cabrillo team was thorough, a survey of SSC-SD ERP end-users revealed that 52% of end-users believed that the ERP

training offered was not sufficient preparation for "go live" [Ref. 74]. The primary reason for this belief was that there was too much time between the training sessions and the actual deployment of the system. The system was still in development when the initial training was conducted; therefore, by the time the system was rolled out, some screens and procedures used in earlier training had changed [Ref. 74]. However, once the system went live, many of those complaining of inadequate training agreed that the hands-on follow-up training had been very beneficial.

There is no guarantee that a process transition of this magnitude will be easy to understand and operate at the beginning. The key is that the Project Cabrillo Team understood that training would be essential for a proper transformation into an ERP environment. Just as with other successful ERP implementations, they trained workers "just in time", created "sandboxes", held classroom instruction, established a "help desk", and continued to communicate with the entire organization.

5. Data

During the transition to ERP at SSC-SD, all normal "day to day" operations within the project codes of SSC-SD continued with only slight operational changes for the ERP cutover period of June 2001. Therefore, the visibility and the integrity of the financial data converted from the Defense Industrial Financial Management System (DIFMS), and its front-end feeder systems, to the SAP software were

critical to both the Project Cabrillo Team and the Office of the Assistant Secretary of the Navy (Financial Management and Comptroller), Financial Operations (OASN(FM&C/FMO)). Therefore, a data conversion strategy was followed that ensured accurate, "clean" data were loaded into the ERP system.

The data from DIFMS, its feeder systems, and other critical legacy Oracle systems were loaded into an intermediate Oracle system to allow for cross-referencing, analyzing, verifying, and reconciling the pre- and post-loaded data for conversion. This database became the control point, allowing the team to add non-DIFMS data required for the conversion and to view the data prior to conversion. This intermediate database was used for storing, reconciling, and transforming legacy data into a SAP acceptable format and was the direct source for conversion to SAP [Ref. 40].

Business rules were established to guide the conversion. The rules varied based on the type of transaction and business requirements once operational on SAP. For example, only open documents and limited historical data were to be converted. SAP discourages the conversion of historical data, but it was necessary to convert actual costs and billings for open funding documents (e.g. sales orders) to ensure funds balances, future billings, and sponsor reporting remained intact [Ref. 40].

In executing the data conversion, several steps were involved. The steps included data identification, data mapping, data cleansing, transformation rules and logic, and preparing the system environment [Ref. 40]. A validation process was executed at critical points by the business process teams and data conversion team for the loading of data from legacy systems into the SAP format. Control totals were established to match legacy control totals at a gross level. Finally, business owner approval and sign-off were required prior to the actual conversion of the data.

The following are a few of the lessons learned by the Cabrillo Data Conversion Team from the conversion of legacy data to ERP [Ref. 40]:

- The use of centralized database architecture is invaluable in assisting with the data conversion, start-up, transition, research, and normal processing into SAP. This also allowed for loading of data extracted from SAP to permit comparison with data from legacy systems.
- Develop detailed control totals from legacy data to verify against the converted data at each step of the conversion process.
- Use data query tools familiar to the functional and technical teams to enable them to share, verify, and approve data prior to loading into SAP.
- "Clean The Data". Perform extensive pre-validations to correct legacy data prior to loading into SAP. This is a critical step that should be started early to reduce the number of

records that have to be converted and to prevent data integrity problems and inconsistencies within SAP.

- Adequately staff the functional teams to cover all aspects (e.g. data conversion, interface, reporting, and configuration design) of the implementation process for the functional area. Support must be available to develop the specifications and to assist in the validation of data conversion test results and data files.
- Testing is a critical, iterative phase for data conversion programs. Conduct testing of mock conversions to work out proper sequencing, time estimates, and software fixes.
- Post conversion capabilities are needed to assist users in understanding what data were converted and how the data appear in SAP.

Both private sector research and interviews with Project Cabrillo team members indicate that data conversion is the most critical step of the transformation process [Ref. 4]. The goal of ERP is to integrate an organization around one common database. Therefore, without accurate data, the database is not valid and the effort, fruitless (i.e., garbage in/garbage out). The number of transactions to convert, level of data, and type of data will influence the time required for the actual execution of data conversion. Also, "down time" during transition to the new system should be minimized to keep from disrupting ongoing business operations. Consequently, an organization can expect to work continuously to convert and validate data.

C. SSC-SD UNIQUE ERP IMPLEMENTATION OBSTACLES

In addition to the previous challenges common with many ERP implementations, the following obstacles were specific to Project Cabrillo. Given that processes at SSC-SD are similar to other Navy Working Capital Funded organizations, organizations planning to implement ERP can apply the following when developing their strategy.

1. Memorandums Of Agreement (MOA)

The day-to-day financial operations within SSC-SD required the involvement of external stakeholders. For example, legacy systems and data managed and owned by the Defense Finance and Accounting Service (DFAS) and Defense Information Systems Agency (DISA) were used on a daily basis. In order for ERP to be implemented, systems owned by these agencies would have to be suspended or the data generated by these systems would be reformatted into SAP user-friendly format. This required Memorandums of Agreement (MOA) between SSC-SD and the external agencies involved.

For example, the most critical was the suspension in the use of DIFMS. DIFMS was the chart of accounts that SSC-SD operated until ERP. All savings outlined in the original business case analysis (BCA) were predicated on the suspension of DIFMS and conversion to ERP. DISA's Central Contractor Registration (CCR) is a mandated system for commercial vendors to register in order to contract with the Department of Defense (DOD), the National Aeronautics and Space Administration (NASA), the Department

of Transportation, and the Department of Treasury. CCR possessed critical data (e.g. vendor name, address, etc.) to be loaded into the SAP software in an effort to operate an accounts payable (i.e. vendor billing) process within SAP.

To suspend systems or manipulate data generated from external systems required agreement, understanding, and accountability by both parties involved. Members of the Project Cabrillo Team emphasized that MOAs should be crafted and signed six months prior to "go live". Until they are signed and agreed upon, testing, data integration, and the actual "go live" will not happen. The end result will be a delay. At SSC-SD, all required MOAs were not signed until three months prior to "go live". This short period allowed little time to work out any issues that surfaced in using data from these systems [Ref. 4].

2. Government Processes In A Commercial System

Private sector firms not only provide a service or product, they do this in order to earn profit and maximize shareholder equity. Governmental financial management is designed to ensure proper resources are available for an agency to provide a needed service for the taxpayer (e.g., national defense). Furthermore, there are unique laws that restrict how government funds can be utilized by those agencies: For example, 1) the "color of money" statute (31 U.S. Code Section 1301a); 2) the Antideficiency Act (31 U.S. Code Section 1517a); and 3) the time allotted to

obligate types of funds (e.g., two years to obligate RDT&E funds).

In discussions with members of the Project Cabrillo team, they discovered that ERP does not recognize the regulations associated with federal appropriations. Just as private sector firms, ERP systems recognize all funds as the same (i.e. money is money). At SSC-SD, depending on the project office, different types of appropriations are used for different reasons. For example, a project office cannot use Operations and Maintenance, Navy (O&MN) funds for investment expenditures such as procurement. This exemplifies the "color of money" statute. Given these constraints, it was essential to put controls in place prior to receiving authorization to secure DIFMS from FMB and DFAS.

Though many consultants and ERP implementation experts state that customization of ERP must be minimized, there was some customization required with Project Cabrillo. Accountability of appropriated funding exemplified this need. The following will outline the controls, both electronic and human, that are in place during the funds authorization phase of a project at SSC-SD.

a. Work Received

Once an SSC-SD project office has assessed that they can provide a reimbursable service for a specific customer, the project office will impute the customer's

reimbursable funding information directly into ERP in support of the project. With the funding information imputed, it is forwarded electronically via ERP to SSC-SD's Funds Processing Office for final approval. This is the first control. Though the accounting information is in the system along with a proper work breakdown structure (WBS), the project office cannot initiate any purchase requests (PR) against the funds until final authorization by Funds Processing personnel.

b. Funds Processing

In an electronic-mailbox, designated personnel in SSC-SD's Funds Processing office will review the funding documents forwarded by the project offices. Not only is the project office's imputed information screened; the accounting data provided by the customer are verified. This is performed by cross-referencing their provided accounting information with all current and active accounting data as provided by DFAS [Ref. 4]. The cross reference is conducted by the creation of a Centralized Master Edit Table (CMET) within ERP. The SAP software provides the capability to create configurable tables, such as the CMET, in order to enhance business processes and meet the specific needs of an end-user.

c. Authorization

Once the CMET review is complete, authorization of funds continues by Funds Processing personnel entering an expiration date for the funds into ERP based on the type of funds (e.g., Shipbuilding and Conversion Navy (SCN)

obligation period is five years). With the expiration date established, CMET review complete, and a Funds Processing personnel assessment of the LOA complete, funds are now officially authorized. Project offices can now develop job order numbers (JONs) for the purchase of material and the accrual of labor hours for the project.

d. Controls

(1) Human. No system, by itself, is capable of ensuring that funds are properly managed in accordance with the "color of money" statute [Ref. 4]. The human element is also required. In the preceding example, accountable personnel are reviewing the funding LOA in support of the project requirements document starting with: a) the levels of approval within the customer's command, b) the levels of approval within the SSC-SD project offices, and finally c) the levels of approval within SSC-SD's Funds Processing office. For example, all of the four services are authorized Operations and Maintenance (O&M) funding (i.e. O&MN, O&MMC, O&MA, and O&MAF). However, the logic within the SAP software alone cannot ensure that O&M-Navy funds are not used for a Marine Corps funded project requiring O&M funds. The human control element accomplishes this through visual review based on the reviewer's position within SSC-SD's organization combined with assigned ERP password security.

(2) Obligation Period. When the designated Funds Processing personnel impute the expiration date of the funds, ERP now recognizes the obligation period associated with the specific line of accounting (LOA) [Ref.

4]. For example, if the funding is received and authorized on 1 August 2002 and expires on 30 September 2002, ERP recognizes that it is current year funding, but will expire 30 September 2002. Using imbedded logic, if a purchase request (PR) date does not fall prior to the expiration date of the funds cited, ERP will not allow the PR to process.

(3) Obligation Threshold. Though the project offices now have control of moving funds around in support of a project, they cannot obligate more than what was originally authorized by Funds Processing [Ref. 4]. If the project office tries to obligate in excess of the amount authorized, an error window appears preventing the obligation to process.

(4) CMET Validation. A final control exemplified by the example is the Centralized Master Edit Table (CMET) validation. Using information that is downloaded from DFAS twice per day, the CMET is a tool that displays all of the authorized and most current Department of Defense (DOD) LOA [Ref. 4]. If the LOA submitted by a customer does not validate with the CMET, the project office can contact the customer to verify what was submitted or have them resubmit an authorized LOA. Until corrected, Funds Processing will not authorize the LOA and no work can accrue in support of the project citing the erroneous LOA.

e. Additional Efficiencies

Additionally, by using the CMET as a front-end check, other efficiencies are gained. Correcting the problem LOA in the beginning of the process can prevent an unmatched disbursement later. For example, under the old process, if there was a transposition error in the LOA provided by the customer and what a project office submitted, the error would not have been discovered until all documentation arrived at the DFAS operations in San Diego, typically after disbursements had been executed. This is due to delays from paper distribution process between the project office, comptroller's office and DFAS. Though DFAS may have paid the suppliers, an unmatched disbursement existed in that the LOA that was cited for the disbursement did not match the customer's obligation LOA. The CMET check conducted by Funds Processing will eliminate this problem [Ref. 4].

To ensure that ERP would properly control and manage appropriated funding, cross-functional teams involving the business process owners (e.g., comptroller and project offices), external stakeholders (e.g., DFAS), and ERP integrators outlined the current "As Is" financial processes executed at SSC-SD. By using this cross-functional team approach, it ensured that all details were discussed when developing new business operations processes for the ERP environment; for example, referencing projects by work-breakdown structure (WBS) vice utilizing SAP generated report numbering. This is very important to the end-users of different SSC-SD departments when querying

project technical and financial information [Ref. 77]. However, without the proper representation of the development teams, this could have been overlooked resulting in rework.

Maintaining accountability, adhering to law, and operating, as prudent businesspersons are bedrock principles within governmental financial management. The controls that are in place for appropriated funding at SSC-SD ensure that those principles are inherent in their ERP system. SSC-SD's ERP system allows project managers the capability to manage authorized funds (i.e. they can move money around if required without the comptroller's intervention). At the same time, the ERP system meets the requirements of funds control as prescribed by the Assistant Secretary of the Navy, Financial Management & Comptroller's (ASN(FM&C's)) *Guide to Federal Requirements for Financial Management Systems* (a.k.a. The Blue Book).

There are many challenges in applying required government processes and rules to a system designed for the commercial sector. The specific challenges at SSC-SD reinforced the requirements for: a proper implementation and integration plan; proper legacy system mapping; and adequate time and resources being made available for the integration and testing of the system prior to "Go Live". Also, training must have priority, top-level support, and adequate resources allocated. Project Cabrillo demonstrated that efficiencies could be gained while

delegating control and minimizing paperwork and the cycle time associated.

3. Ramp Up

The "cutover" from DIFMS to ERP at SSC-SD was not as easy as securing DIFMS on 1 June and fully operating on ERP on 2 June. "Ramp Up" was the time period between completing the conversion from legacy systems on 1 June 2001 to "Go Live" on ERP on 28 June 2001, roughly four weeks. During this time, automated financial transactions were severely limited. Keep in mind, business at SSC-SD was not secured in order to implement ERP.

In preparing for "Ramp Up", communication throughout SSC-SD was critical. The organization as a whole was the critical player in "Ramp Up". Work Centers that utilized DIFMS and other eliminated legacy systems had to prepare for ERP. An effort was made to plan ahead for ramp up to include: purchasing needed material two to three months prior to "cutover"; minimizing business transactions during the transition period to only those deemed critical; and maintaining organized paper documentation during the transition period to expedite input of those transactions into SAP once live [Ref. 4].

When the Project Cabrillo Team planned for this event, there was no assurance that it would run smoothly when the actual transition was complete. ERP "Go Live" did not mean full ERP deployment [Ref. 4]. Personnel were still

learning how to operate the system, conduct normal business, and adapt to drastic changes during the "Ramp Up" period. The following are specific lessons learned by the Cabrillo Team [Ref. 4]:

- Be flexible and prepared to modify the plan. Their plan was an estimate of timeframes and activities required to "catch up" the transactions during the transition period.
- Plan "Ramp Up" early and engage business operations personnel. Be realistic about how long "Ramp Up" will take. Share responsibilities for decision-making. Begin transition of "Ramp Up" from the project team to the business operations personnel.
- Communicate status of "Ramp Up" to Cabrillo project team, process owners, legacy system owners, end users, and external organizations. This is critical given the chaos that could surface during such a large transition.
- Do not underestimate the staffing requirements to "catch up" the business. Assess the volume of business that will be inputted into ERP after "Ramp Up". Cross train, where possible, and involve knowledgeable end-users to augment the resource pool. Try to catch up as much of the business as possible prior to full deployment to all end-users. The reason is that this could be a resource constraint because of the demand by end-users for assistance from knowledgeable users and the help-desk.
- Assign a central liaison for coordination with external organizations for resolution of interface issues. Contact organizations (DFAS, FMB) and inform them of "Ramp Up" schedule and when "switches" need to be made to support the new processes.
- Assign responsibility for review and monitoring of error transactions. As transactions are entered or batch processes run, end users will

not be prepared to begin the monitoring and correction of rejected or erroneous items. Establish methods for monitoring rejects and assessing causes of problems. This can ensure that the word gets out to end-users and the same problem will not resurface.

D. SUMMARY

Based on our research of ERP implementations within private sector and that of SSC-SD, commonalities in implementation obstacles did exist. Additionally, specific challenges, driven by the structure of governmental financial management, were encountered and overcome by the Project Cabrillo team on their path to "Go Live". Their techniques and ability to overcome unique challenges lead to a successful ERP implementation at SSC-SD and are models for other DOD organizations to emulate. Chapter VI will outline final conclusions on the research conducted on Project Cabrillo answering the specific questions from Chapter I, recommendations for DON ERP implementation, and suggestions for further areas of research.

THIS PAGE INTENTIONALLY LEFT BLANK

VI. CONCLUSIONS AND RECOMMENDATIONS

A. SUMMARY

In response to the Federal Financial Improvement Act, the initiatives of the Department of the Navy's (DON) Revolution in Business Affairs (RBA) office, and the goals of President George W. Bush's administration, the DON has chosen ERP, Enterprise Resource Planning, as a foundation for change in business practices and the improvement of financial management systems. This thesis examined the first of four DON ERP pilot implementations at the Space and Naval Warfare Systems Center San Diego (SSC-SD). Specifically, comparisons were drawn between both successful and unsuccessful ERP implementations within private sector organizations and that of SSC-SD. From the comparison, if there were commonalities in implementation challenges, those commonalities could be applied to future ERP implementations in both the DON and Department of Defense (DOD). The findings were based upon interviews and data collected.

From the comparison, commonalities did exist in ERP implementation challenges between private sector organizations and that of SSC-SD. Additionally the management techniques used to mitigate those challenges were similar. Finally, due to SSC-SD's financial management structure and appropriated funding constraints, unique obstacles were discovered during the implementation. These unique obstacles will be encountered by other Working Capital Funded (WCF) organizations planning to implement

ERP on the same scale as SSC-SD. This thesis supports that the implementation of ERP at SSC-SD was a success based on industry comparisons, the goals of Project Cabrillo's BCA, and their Chief Financial Officer (CFO) Act compliancy assessment in January 2002.

B. RESEARCH QUESTION

- 1. Primary: Given the current constraints within the Department of Defense (DOD) on infrastructure investment, what aspects of an ERP implementation must be closely managed in order to increase success?**

Based on our industry research, there are 13 key challenges organizations must manage in order to ensure ERP implementation success. They are:

a. *Business Case Analysis (BCA) Development*

Within commercial industry, this was deemed to be the most important driver in achieving ERP implementation success. Focus must be on improving the processes, not automating current problems. Honest business assumptions, quantifiable results, and achievable goals must be outlined with a specific plan and calendar that can be tracked throughout the implementation. The organization, not the consultants, must develop this document.

b. Metrics

Metrics to measure the implementation and post "go live" operation should be consistent with how the firm delivers value to its customers and stated in meaningful terms. The metrics should stem from the organization's business strategy, have ownership, be timely, and be drawn from established standards. From an executive level, only a manageable number of metrics (e.g. 3 to 10) should be tracked. Also, the metrics should add value in assessing ERP's success in contributing to the organization's strategic objectives.

c. Senior Leadership Commitment

As with all change in an organization, strong leadership is essential. Leadership must come from both business operations and information systems. Additionally, turnover within critical leadership positions must be minimized.

d. Return on Investment (ROI)

Return on Investment (ROI) can be measured in numerous ways. This is where difficulties arise because soft and non-quantifiable benefits attributed to ERP cannot always be translated to hard figures. When developing ROI in support of an ERP implementation, methods to generate ROI must be consistent. Also, the results must be honest and achievable, to ensure that finance and information systems must work together to develop a single methodology.

e. Change Management

The number one reason for ERP implementation failures within the private sector can be attributed to poor change management. There will be negative connotations associated with an ERP system implementation by members of the organization. These range from fear of losing their jobs to fear of losing authority. Change management teams need to be developed to market the goals and benefits of ERP and eliminate threats to the program. Teams should be lead by senior management. The goal is to communicate and abolish fear.

f. Productivity Dip

Immediately after ERP implementation, organizations experience this phenomenon. This is directly attributed to the change in processes and how business is conducted. The steepness of this dip is directly correlated to the effectiveness of both training and change management.

g. Personnel Recruitment, Teambuilding, and Retention

When establishing ERP implementation teams, the best and brightest must be recruited. The teams should be empowered to make change. Also, incentives should be provided for those team members in conjunction with specific implementation milestones. Utilizing consultants is common. If used, they should not drive the direction of the teams.

h. Document

It is important to document everything that is done throughout the entire lifecycle of the system. This helps to ensure compliance with the business case analysis (BCA) for measurement and provide background for any new employees in the software support section.

i. Data Integration

Integrating data from legacy systems to the ERP environment can cause bottlenecks and drive up overall implementation costs. This is due to the fact that old data are inaccurate and must be formatted to ERP software. The ability to map legacy systems to format the old data to operate in the ERP system is critical in preventing bottlenecks. Testing and integration time must be sufficient and not overlooked by non-technical leadership. Data integration is a critical step in the process because the system is only as good as the data inputted.

j. Costs

Costs are the top negative perception associated with an ERP system. Private sector implementation costs have ranged from \$400,000 to \$300,000,000 depending on scope and the firm's market. Costs stem from the software, hardware, licensing, updates, staff, and consultants required for the implementation. On average, final price tags for an ERP implementation are 25% above the initial estimate. To manage costs, minimize customization of the software, eliminate legacy systems, limit the

implementation schedule, and incorporate incentives into the implementation and integration contract.

k. Training

Always underfunded and the first to get cut in budgets, it is a must for an ERP implementation. Dedicated training teams should be developed for delivering classroom and just-in-time training (i.e. when needed). At the initial "go live", a help-desk should be manned to provide assistance. Also, develop feedback loops to enhance training techniques and plans.

l. Maintenance & Support

Maintenance and support does not end with fielding. In order to attain the full return of an ERP investment, these support costs must be treated as necessary and required expenses (i.e. total ownership cost). Future budgets must allow for these expenses.

m. Security

Security must be built into the software engineering process. This will eliminate cost in the long run. Security must be a critical element when developing the BCA.

2. Secondary:

- a. *What commonalities exist between Space and Naval Warfare Systems Support Center San Diego (SSC-SD) Project Cabrillo implementation and those of private sector organizations?*

In comparing the Project Cabrillo ERP implementation with those of private sector organizations, commonalities existed in the following: business case analysis (BCA) development, data integration, training, project metrics development, and commercial-off-the-shelf (COTS) utilization.

In both public sector and SSC-SD's ERP implementation, the business case analysis was a critical tool in managing the project from beginning to end. Honest business assumptions with achievable goals were incorporated in its development. The Project Cabrillo drove the process vice the consultants. The business process owners and organization leadership were involved in its development and are involved in monitoring.

Data integration and conversion was the most critical step in Project Cabrillo [Ref. 4]. The use of an integration team and a stand-alone system to format data prior to upload to ERP was critical. Just as with the public sector, understanding of how data operated in the legacy systems was critical. This is the step in implementation where bottlenecks can develop due to quality

checks of the converted data resulting in schedule delays, which result in implementation cost increases.

Training was critical given the dramatic change in business processes due to the ERP implementation. Public sector research revealed that failed implementations were linked to limited resources allocated to training. On the other hand, those that did succeed with an implementation credited training as the catalyst for getting the organization "on board" focused on succeeding. Project Cabrillo followed the paths of success stories. They devoted resources and considerable time to training. They utilized mock ERP systems for end-users to practice. Also, as "Go Live" closely approached, they increased the number of knowledgeable users to assist with "just in time" training.

Project metrics were developed utilizing the balanced scorecard (BSC). Through analysis of "As Is" and "To Be" business processes, nine primary key performance indicators (KPI) and 32 sub-KPIs were developed tying Project Cabrillo's capabilities to SSC-SD's strategic goal of "Improving Business Operations". Additionally, specific personnel were responsible for the status of the nine primary KPIs. The end result was a metric system that is timely and manageable while generating valuable data critical in SSC-SD achieving their strategic goals.

The cornerstone of the vision held by the Revolution in Business Affairs (RBA) was to assess the best business practices of the commercial sector and incorporate those practices into Department of Defense (DOD) business practices to attain efficiencies and save money. This principle contributed to not only choosing ERP, but also to incorporating the best business processes with the software. Many organizations fail to optimize potential efficiencies and savings associated with ERP because they over-customize the software to fit their processes. Successful implementation projects, both commercial and public, assert that incorporating better business processes with an ERP implementation is where actual saving generation begins. For example, prior to ERP at SSC-SD, purchase request (PR) generation was paper intensive, requiring multiple data entries into separate systems. However, by SSC-SD incorporating better business processes with ERP, all purchase request generation and processing is now conducted totally via ERP without external systems and minimal human intervention.

b. What were the unique obstacles discovered during Project Cabrillo's implementation.

In addition to the previous commonalities in ERP implementation between SSC-SD and private sector organizations, there were unique challenges faced by Project Cabrillo in attaining implementation success. Those specific challenges include attaining the required memorandums of agreement (MOA) from key external stakeholders; ensuring appropriated funding accountability and control; and "Ramp Up" or the cutover from Defense

Industrial Financial Management System (DIFMS) to ERP "Go Live".

The day-to-day financial operations at SSC-SD require the involvement of external stakeholders that either provide systems and data or use SSC-SD's data in the execution of their mission. For example, the Defense Financial and Accounting Service (DFAS) owns DIFMS. DIFMS is the chart of accounts for the Department of Defense (DOD) and was used at SSC-SD prior to ERP. However, as outlined in the Project Cabrillo business case analysis (BCA), in order to attain the potential savings afforded by ERP, all business assumptions were based on the suspension of DIFMS at SSC-SD. This required an MOA between the DON and DFAS in order to suspend the use of DIFMS. The longer the delay in attaining that MOA, the longer it takes to integrate and test the data from DIFMS, or other externally owned systems, to ERP. The end result could have been a schedule problem, which would have translated into cost increases due to consulting and integration fees. SSC-SD recommends that MOA should be initiated with the inception of an ERP plan.

With ERP's roots in the private sector, there are some required adjustments to processes and controls in order to operate ERP within a governmental financial environment. As a Navy Working Capital Funded (NWCF) organization, SSC-SD's business model is very similar to private sector organizations. However, SSC-SD's goal is to break even vice achieve a profit. Off the shelf, ERP does

not recognize the constraints associated with appropriated funding (i.e. purpose, obligation time limits, and dollar thresholds). To resolve this issue, utilization of configurable tables provided by the SAP software, controls were established. This allowed an approval process for funding authority based on security levels associated with organizational position. Though this is a form of customization, it is required in order to achieve accountability and control. However, this is not a customization of SAP's core code. Therefore, it meets the requirements of the CFO Act in that core coding cannot be manipulated in order for an agency to execute their business processes.

With "Go Live" scheduled for 28 June 2001, the month of June was dedicated to transitioning from DIFMS to ERP. This period was called "Ramp Up". During "Ramp Up", automated financial transactions were severely limited. A "cutover" plan from DIFMS to ERP was developed in advance requiring: all of SSC-SD to purchase material two to three months prior; minimal business transaction during the month of June limited to critical; documentation on paper of all transactions occurring in June to be loaded into ERP after "Go Live". A critical element of this transition that added to its difficulty is that normal business did not suspend.

c. Can such challenges be overcome and, if so, how?

The challenges encountered by SSC-SD are unique in comparison to private sector implementations. However, other working capital funded (WCF) organizations within the DOD will experience the same challenges due to the similar structure of the organizations. Specifically:

Memorandums of Agreement (MOA) will be required because a large percentage of DOD organizations utilize systems and data of other organizations in their day-to-day financial operations. For example, the reporting of time and pay by DOD employees is required to be maintained on the Defense Civilian Personnel Data System (DCPDS). This is a DOD mandated system. However, it is critical in the operation of SSC-SD financial operations from a civilian labor perspective. Therefore, to use its data or to interface it with ERP requires the approval of DFAS. ERP implementation projects must start early in attaining Memorandums Of Agreement (MOA) from critical external organizations. This includes getting them involved and made part of the project as members of business process cross-functional teams. Specifically, those systems critical for success must be identified up-front in the BCA.

Due to ERP's inception from the commercial sector, software providers and integration experts must be tempered by governmental process experts when analyzing "As Is" business processes and creating "To Be" processes.

Minimal customization of the system, though not desired, will be required to ensure control and accountability of appropriated funding. SSC-SD demonstrated how this customization enhanced their processes while ensuring accountability. In discussions with Project Cabrillo team members, the creation of cross-functional teaming with SSC-SD business process owners, external organizations (e.g. DFAS) and ERP experts was critical in ensuring that all important process were mapped out prior to developing the "To Be" business environment [Ref. 77].

Aside from the unique challenges encountered at SSC-SD with their ERP implementation, the overall success of Project Cabrillo may be attributed to strong leadership, an experienced project management team, process change authority delegated to Project Cabrillo, and the willingness of the SSC-SD organization to change their processes [Ref. 4]

B. CONCLUSIONS

Based on this research, Enterprise Resource Planning provides the capabilities required to improve business processes as envisioned by the Department of the Navy's (DON) Revolution in Business Affairs (RBA). Additionally, the capabilities of ERP are in alignment with the goals of President Bush and Secretary of Defense Rumsfeld to update financial management systems while providing more accurate and timelier information. However, there are challenges to an ERP implementation within the DON and DOD driven by the structure of the federal financial management process (i.e.

mandated legacy systems and processes) and the laws associated with appropriated funding. Though inefficient, they serve a purpose in that accountability to the taxpayer is maintained.

In order for total efficiencies and savings to be realized with an ERP system, control must be delegated throughout the entire enterprise. However, this requires training, trust, and efficient checks and balances to be established in order to maintain the required accountability. At SSC-SD, processes have been developed to ensure that the legislative constraints of appropriated funding are met. However, these processes dampen full ERP efficiency realization. To fully attain ERP effectiveness, the legal constraints associated with appropriated funding would have to be re-evaluated or eliminated.

C. RECOMMENDATIONS

On 9 April 2002, the Department of Defense (DOD) selected International Business Machines (IBM) to develop a DOD-wide financial management enterprise architecture (Ref. 79). Accordingly, the Assistant Secretary of the Navy for Research, Development, and Acquisition (ASN RD&A) has tasked the four DON ERP pilots to submit a plan on how the DON will contribute to the DOD's future enterprise architecture by 30 September 2002 [Ref. 4]. The Secretary of Defense's vision of financial management enterprise architecture across DOD is exactly what is required in order to integrate over 967 stand-alone financial systems and improve DOD business processes [Ref. 78]. However,

given the cost and time to implement, this must be a priority that withstands the change in administrations and is allocated the proper resources to ensure the achievement of desired goals.

Additionally, techniques that contributed to the successful implementation at SSC-SD must be incorporated to a DON ERP development plan and that of the DOD. Those techniques include:

- The development of an effective data integration and training plan
- The use of cross-functional teams
- The development of an accurate business case analysis with honest business assumptions and achievable goals
- The development of performance metrics that are manageable and valuable
- The incorporation of commercial-off-the-shelf processes in order to maximize efficiencies provided by an ERP solution

Though different organizations within DON and DOD will be involved in this process, the above techniques will cross organizational boundaries while enhancing the DOD strategy.

D. AREAS FOR FURTHER RESEARCH

The focus of this research was to analyze SSC-SD's implementation of ERP against that of the private sector. The research uncovered some potential areas of additional

research not covered in this thesis. Further research could be conducted in the following areas:

- Should there be changes to federal legislation that would allow less oversight in the management of appropriated funding in order to operate in a COTS financial system?
- Can provisions be implemented that would give management the latitude to offer tangible incentives to attract and retain ERP experts in order to minimize the reliance of contractors?
- Given the wide range of financial management processes within the Department of Defense, can there be one enterprise resource financial management solution at an affordable price?
- Given the lessons learned from the four DON ERP pilots and the current initiatives by the Defense Logistics Agency and Army Material Command, what is the best strategy for the DOD to implement an enterprise resource management system?

APPENDIX A DETAILED HISTORY OF ERP

- 1960s** Enterprise Resource Planning (ERP) is born in the early 1960s from a joint effort between J.I. Case (Racine, WI), the manufacturer of tractors and other construction machinery, and partner IBM. Material Requirements Planning or MRP is the initial effort. This application software serves as the method for planning and scheduling materials for complex manufactured products.
- 1970s** Initial MRP solutions are big, clumsy and expensive. They require a large technical staff to support the mainframe computers on which they run.
- 1972** Five engineers in Mannheim, Germany begin the company, SAP. The purpose in creating SAP is to produce and market standard software for integrated business solutions.
- 1975** Richard Lawson, Bill Lawson, and business partner, John Cerullo begin Lawson Software. The founders see the need for pre-packaged enterprise technology solutions as an alternative to customized business software applications.
- 1976** In the manufacturing industry, MRP (Material Requirements Planning) becomes the fundamental concept used in production management and control.
- 1977** Jack Thompson, Dan Gregory, and Ed McVaney form JD Edwards. Founders take part of their name to create the company moniker. Larry Ellison begins Oracle Corporation.
- 1978** Jan Baan begins The Baan Corporation to provide financial and administrative consulting services.
- 1979** Oracle offers the first commercial SQL relational database management system.
- 1980** JD Edwards begins focusing on the IBM System/38 in the early 1980s. MRP (Manufacturing Resources Planning) evolves into MRP-II as a more accessible extension to shop floor and distribution management activities.
- 1981** Baan begins to use Unix as their main operating system.
- 1982** Baan delivers its first software product. JD Edwards focuses on the IBM System/38.
- 1983** Oracle offers both a VAX mode database as well as a database written entirely in C (for portability).
- 1984** Baan shifts the focus of their development to manufacturing.
- 1985** JD Edwards is recognized as an industry-leading supplier of applications software for the highly successful IBM AS/400 computer, a direct descendant of the System/38.
- 1986** PeopleSoft is founded by Dave Duffield and Ken Morris in 1987
- 1987** PeopleSoft's Human Resource Management System (HRMS) is developed.

1990	Baan software is rolled out to 35 countries through indirect sales channels. The term ERP (Enterprise Resource Planning) is coined in the early 1990's when MRP-II is extended to cover areas like Engineering, Finance, Human Resources, and Project Management.
1991	PeopleSoft sets up offices in Canada. This leads the way to their presence in Europe, Asia, Africa, Central and South America, and the Pacific Rim.
1995	Baan grows to more than 1,800 customers worldwide and over 1,000 employees
1999	JD Edwards has more than 4,700 customers with sites in over 100 countries. Oracle has 41,000 customers worldwide (16,000 U.S.). PeopleSoft software is used by more than 50 percent of the human resources market. SAP is the world's largest inter-enterprise software company and the world's fourth largest independent software supplier overall. SAP employs over 20,500 people in more than 50 countries. To date, more than 2,800 of Baan's enterprise systems have been implemented at approximately 4,800 sites around the world.
2000 and Beyond	Most ERP systems are enhancing their products to become "Internet Enabled" so that customers worldwide can have direct access to the supplier's ERP system.

Figure A.1. Detailed History of ERP (From: Ref. 10)

APPENDIX B PREDOMINATE ERP PROVIDERS

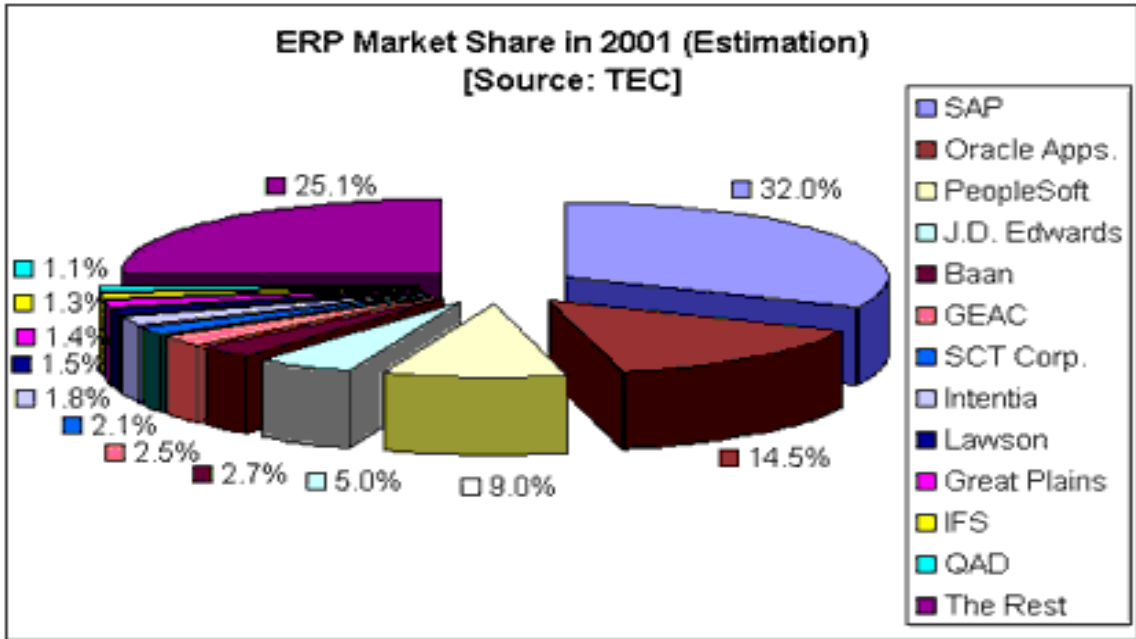

Figure B.1. Market Share (From: Ref. 15)

Over 60% percent of the market is still controlled by the following five companies in order: SAP, Oracle, Peoplesoft, J.D. Edwards and Baan [Ref. 15].

1. SAP

SAP (NYSE: SAP) is headquartered in Walldorf, Germany and has been the forerunner in the development of ERP since its foundation in 1972 by five IBM engineers. According to SAP's web page (www.sap.com) it is not only the largest inter-enterprise software company, but it is also the third-largest independent software supplier employing over 27,800 people in more than 50 countries and are the leader in e-business solutions. In 2001, SAP recorded sales

exceeding \$6.4 billion and supplied more than half of the top fortune 500 companies with its ERP system, known as R/3.

2. Oracle Corporation.

Oracle Corporation (Nasdaq: ORCL) is headquartered in Redwood Shores, California. Larry Ellison, Rob Miner, and Ed Oates founded Oracle in 1977. On its website (www.oracle.com), Oracle proudly states that it was the first software company to develop and deploy 100 percent Internet-enabled enterprise software across its entire product line: database, server, enterprise business applications, and application development, and decision support tools. In addition, Oracle has over 42,000 employees in over 150 countries and its products are presently utilized by 98 percent of Fortune 500 companies. Oracle's accounting statements also show its strength with more than \$10.8 billion in annual revenue in 2001. However, only a small portion of this revenue can be attributed to its sales in ERP. The company offers its database, tools and application products, along with related consulting, education, and support services.

3. Peoplesoft

Peoplesoft (NASDAQ: PFST) is headquartered in Pleasanton, California and was founded in the mid-1980s by Dave Duffield and Ken Morris. Peoplesoft can be found on the Internet at (www.peoplesoft.com). The company has \$2.04 billion in sales and employs approximately 8,000 employees in 17 countries. Peoplesoft is a designer and

developer of a family of enterprise applications software products based off its Peoplesoft 8 platform for medium and large organizations, higher education institutions, and government agencies worldwide.

4. J.D. Edwards

J.D. Edwards (NASDAQ: JDEC) is headquartered in Denver, Colorado. Jack Thompson, Dan Gregory, and Ed McVaney founded it in 1977. J.D. Edwards website, (www.jdedwards.com) lists its current employees at over 4,700 in various countries with sales exceeding \$1 billion. J.D. Edwards states in their corporate history that their primary focus is on providing Supply Chain Management (SCM) and Customer Relationship Management (CRM) software.

5. Baan

Jan Baan (NASDAQ: BANNF) founded Baan in 1978. The high school dropout and former slaughterhouse clerk started the company in his rural hometown of Barneveld, the Netherlands. The company website (www.baan.com) states that Baan revenues last year were over \$736 million with over 15,000 customer sites worldwide, and is part of the Invensys software systems division - a global leader in the provisions of e-business/automation solutions. Baan's main ERP platform is know as ibaan.

THIS PAGE INTENTIONALLY LEFT BLANK

APPENDIX C COMMON ERP SOLUTIONS

- Project Management: Identifies and captures project costs, manages job resources, tracks materials, labor and overhead, calculates financial indicators as it relates to billing, sales, earnings, interest, and completed projects, and allows viewing of project status [Ref. 16].
- Customer Relations Management (CRM): It is a strategy used to learn more about customers' needs and behaviors in order to develop stronger relationships with them [Ref. 17].
- Product Lifecycle Management (PLM): Makes product information available by rolling together design, simulation and testing information, procurement and logistics documentation, manufacturing data, and CRM technologies [Ref. 18].
- Supply Chain Management (SCM): In order to understand SCM, the supply chain must be defined. The supply chain consists of all stages involved in fulfilling a customer request (i.e. manufactures, suppliers, transporters, warehouses, retailers, and customer service). SCM is a way to supervise the flow products and information as they move along the supply chain, to ensure just-in-time delivery of goods and services are achieved satisfying customer requirements [Ref. 19]. SCM allows for the reduction of inventories, cycle times, and turn around time (TAT) thus creating opportunity for a higher profit margin, while minimizing system-wide costs.
- Financial Management: Provides the ability to process and interpret financial data and perform financial transactions. Enables financial managers to implement budgeting and control processes that fit the needs of individual departments and projects while maximizing efficiency of the budget control process. This module provides the ability to handle billing,

collection, payment processing, cash application, and revenue recognition. In addition, this module provides the ability to produce and track the following financial reports: General Ledgers, Accounts Receivable, Accounts Payable, and Capital Asset Management.

- Human Resource Management: This module encompasses organizational management, benefits administration, time management, payroll administration, and employee development [Ref. 16].
- Business Intelligence (BI): Encompasses the gathering, storing, analyzing, and accessing of data for better decision-making. BI incorporates applications such as decision support systems, statistical analysis, forecasting, querying and report generation, and online analytical processing (OLAP) [Ref. 16].
- E-Commerce (Electronic Commerce): Uses online electronic technology connected via the Internet to assist and enhance a variety of business processes, functions and systems [Ref. 20]. The primary functions are: customer service, sales, advertising, procurement, funds transfer, customer support, and delivery tracking.

APPENDIX D PROJECT CABRILLO 10 YEAR ECONOMIC ANALYSIS

TEN YEAR ECONOMIC ANALYSIS CONSTANT DOLLARS									
Project Title: Enterprise Resource Planning (ERP) System Software									
FY End	2000	2001	2002	2003	2004	2005	2006	2007	2008
COSTS IF ASSET IS ACQUIRED									
Acquisition Costs	18,328,000	14,309,000	5,677,000	5,161,000	0	0	0	0	0
Workyears:									
Civilian	31.8	31.8	16.0	10.0	8.0	8.0	8.0	8.0	8.0
Military	0.0	0.0	0.0	0.0	0.0	0.0	0.0	0.0	0.0
Labor Expense:									
Civilian	2,544,000	2,638,128	1,376,480	887,820	732,984	756,440	780,646	805,627	831,407
Military	0	0	0	0	0	0	0	0	0
Materials	0	0	0	0	0	0	0	0	0
Utilities	0	0	0	0	0	0	0	0	0
Communications	0	0	0	0	0	0	0	0	0
Contractor Support	4,400,000	4,466,000	1,133,248	1,050,830	857,477	874,626	892,119	909,961	928,161
Maintenance & Repair	0	0	0	0	0	0	0	0	0
Other (List): DFAS bill, SLDCADA	5,094,000	5,170,410	2,200,000	2,244,000	2,288,880	2,334,658	2,381,351	2,428,978	2,477,557
Total Operating Expenses	12,038,000	12,274,538	4,709,728	4,182,650	3,879,341	3,965,724	4,054,116	4,144,566	4,237,125
CURRENT OPERATING COSTS									
Workyears:									
Civilian	31.8	31.8	31.8	31.8	31.8	31.8	31.8	31.8	31.8
Military	0.0	0.0	0.0	0.0	0.0	0.0	0.0	0.0	0.0
Labor Expense:									
Civilian	2,544,000	2,638,128	2,735,739	2,823,282	2,913,627	3,006,863	3,103,083	3,202,382	3,304,858
Military	0	0	0	0	0	0	0	0	0
Materials	0	0	0	0	0	0	0	0	0
Utilities	0	0	0	0	0	0	0	0	0
Communications	0	0	0	0	0	0	0	0	0
Contractor Support	4,400,000	4,466,000	4,555,320	4,646,426	4,739,355	4,834,142	4,930,825	5,029,441	5,130,030
Maintenance & Repair	0	0	0	0	0	0	0	0	0
Other (List): DIFMS (CDA, DMC), DFAS bill, SLDCADA	5,094,000	5,170,410	5,273,818	5,379,295	5,486,880	5,596,618	5,708,550	5,822,721	5,939,176
Total Operating Expenses	12,038,000	12,274,538	12,564,877	12,849,003	13,139,863	13,437,624	13,742,458	14,054,545	14,374,064
Acquisition Costs	(18,328,000)	(14,309,000)	(5,677,000)	(5,161,000)	0	0	0	0	0
Net Benefits	0	0	7,855,149	8,666,354	9,260,522	9,471,900	9,688,343	9,909,979	10,136,939
Times: 4% Standard PV Factor	1.0000	0.9690	0.9389	0.9098	0.8816	0.8543	0.8278	0.8021	0.7773
Present Value Benefits Per Year	0	0	7,375,561	7,884,921	8,164,257	8,091,678	8,019,943	7,949,043	7,878,967
Present Value Acq Costs Per Yr.	(18,328,000)	(14,309,000)	(5,330,396)	(4,695,640)	0	0	0	0	0
Net Cashflows(assumed savings)	(18,328,000)	(14,309,000)	2,045,165	3,189,281	8,164,257	8,091,678	8,019,943	7,949,043	7,878,967
Net Present Value	28,252,290								
Internal Rate of Return (IRR)	14.99%								

Figure D.1. Project Cabrillo 10 Year Economic Analysis
(From: Ref. 38)

THIS PAGE INTENTIONALLY LEFT BLANK

APPENDIX E PROJECT CABRILLO 10 COST BENEFIT ANALYSIS

Costs and benefits display:

Evaluation Period	Constant Dollars (Base Year FY00)			Net Present Value (Discounted dollars)	Constant Dollars (Inflated)	Inflation Factor From base Year	NPV %	Project Declining Balance	Payback (Years)
	Operations Costs		Benefits	Benefits	Benefits				
	Status Quo	Alternative	Differential Costs	(Differential Costs)	(Differential Costs)				
FY01	12,274,538	12,274,538	0	0	0	102.20%	\$0.97	43,475,000	0.00
FY02	12,564,877	4,709,728	7,855,149	7,375,561	8,204,578	104.45%	\$0.94	43,475,000	1.00
FY03	12,849,003	4,182,650	8,666,354	7,884,921	9,251,009	106.75%	\$0.91	36,099,439	1.00
FY04	13,139,863	3,879,341	9,260,522	8,164,257	10,102,737	109.09%	\$0.88	(7,884,921)	1.00
FY05	13,437,624	3,965,724	9,471,900	8,091,678	10,560,672	111.49%	\$0.85	28,214,518	1.00
FY06	13,742,458	4,054,116	9,688,343	8,019,943	11,039,639	113.95%	\$0.83	(8,164,257)	1.00
FY07	14,054,545	4,144,566	9,909,979	7,949,043	11,540,616	116.45%	\$0.80	20,050,261	1.00
FY08	14,374,064	4,237,125	10,136,939	7,878,967	12,064,630	119.02%	\$0.78	(8,019,943)	1.00
FY09	14,701,204	4,331,844	10,369,360	7,809,706	12,612,756	121.63%	\$0.75	11,958,583	1.00
FY10	15,036,155	4,428,777	10,607,378	7,741,250	13,186,119	124.31%	\$0.73	(8,019,943)	1.00
Residual value								3,938,640	5.50
Total	136,174,330	50,208,407	85,965,923	70,915,326	98,562,756			(3,938,640)	
		Investment Cost		Investment Cost	Investment Cost			0	
		43,475,000		43,475,000	43,475,000			0	
		Project Total						0	
		93,683,407						0	

20: Number of years based on project economic life
10

Summary Information for all alternatives:

	<u>Alt A</u>
Total Benefits (Current Dollars)	85,965,923
Investment Cost (Current Dollars)	43,475,000
Payback (years)	5.50
BIR	1.63
Productivity Benefits (Workyears)	23.80

Statistical Inputs Section

Present Value Deflator	3.20% from OSD Circular A-94, Appendix C, "Real Interest Rates"
Inflation Inflation	2.20% from OSD Circular A-94, Appendix C, delta between "Nominal Interest Rates" and "Real Interest Rates"

Figure E.1. Project Cabrillo 10 Year Cost Benefit Analysis (From: Ref. 38)

THIS PAGE INTENTIONALLY LEFT BLANK

LIST OF REFERENCES

1. Kann, Jody NAVSUP website Available [Online]
http://www.navsup.navy.mil/prod_serv/supply/erp/index.jsp
2. Office of Management and Budget (OMB), *The President's Management Agenda*, FY 2002 Available [Online] <http://www.whitehouse.gov/omb/budget/>
3. Rumsfeld, Donald "SUBJECT: Financial Management Information within the Department of Defense", Memorandum July 19, 2001
4. John Gorman. Telephone interview 25 July 2002
5. James Hurley, Kenneth Hartley, John Dunleavy, John Balls "E-Business and ERP - Transforming the Enterprise" John Wiley & Sons, Incorporated, 2000
6. ERP fan club, "Enterprise Resource Planning (ERP) Do We Need It?" Available [Online] <http://www.erpfans.com/>
7. Cook, G., Economic Evaluation of Information Systems II, Naval Postgraduate School Course IS4031, Power Point Presentation, 2001

8. Kilian, Maureen "Developing a Winning ERP Strategy" February 18, 2002 Available [Online]
<http://sap.ittoolbox.com/documents/document.asp?i=1702>
9. Mark Morgan, Tom Rappsilber, Matt Galloway, and Troy Wells "Enterprise Resource Planning (ERP)" PowerPoint presentation, unknown
10. Sayfa, Ana "The History of ERP" July 25, 2000 Available [Online]
<http://sistem.ie.metu.edu.tr/HistoryofERP.htm>
11. Tuteja, Akhilesh, "Enterprise Resource Planning: What's There In It!" January 1998 Available [Online]
<http://www.geocities.com/CollegePark/Library/6045/erp.html>
12. Glick, Bryan, *CRM and E-commerce Sales Rise as ERP Falls* Sept 11, 2000 Available [Online]
<http://www.vnunet.com/News/1113814>
13. Dyer, VADM Joseph Commander Naval Air Systems Command "Presentation to Navy Working Capital Fund Financial Management Conference" February 21, 2001.

14. Farver, Dana "2 ERP or ERP 2?" Available [Online] <http://www.agilebrain.com/erp2.html>
15. Jakovljevic, P.J., The ERP Market 2001 and Beyond - Aging Gracefully With the "New Kids On the Block" October 3, 2001 Available [Online] <http://www.technologyevaluation.com>
16. Dawson, Matthew L., "ERP" Available [Online] <http://www.erpassist.com/pub/MD042202.htm>
17. Deck, Stewart "What is CRM?" May 23, 2001 Available [Online] <http://www.cnn.com/2001/TECH/industry/05/23/what.is.CRM.idg/>
18. Fernandez, Frank "How PLM helps" February 18, 2002 Available [Online] <http://www.manufacturing.net/dn/index.asp?layout=articleCurrentWeb&articleid=CA194911>
19. Pender, Lee "What is SCM?" June 28, 2001 Available [Online] <http://www.darwinmag.com/learn/curve/column.html?ArticleID=123>

20. IBC Internet Business Corporation "What is E-Commerce" Available [Online]
<http://www.ibc.com.au/aboutecom.cfm>
21. Krell, Eric "Shattering ERP Misconceptions" Business Financial Magazine March 18 2002 Available [Online]
<http://www.businessfinancemag.com/archives/appfiles/Article.cfm?IssueID=359&ArticleID=13839&CurrChannel=11>
22. Pender, Lee "Faster, Cheaper ERP" CIO Magazine, May 15, 2001 Available [Online]
<http://www.cio.com/archive/051501/faster.html>
23. Anderegg, Travis "ERP and Internet: Are WE In Love or Are We Just Friends?" Available [Online]
<http://www.cibres.com/articles/rfeature-articles-ERP-and-internet.asp>
24. Daté, Shruti "Feds Take Hard Look at Use of Enterprisewide Systems". *Government Computer News* September 27, 1999
http://www.gcn.com/vol18_no32/news/701-1.html
25. Hleba, Ted Practical Financial Management: A Handbook of Practical Financial Management Topics for the DOD Financial

Manager, Third Edition January 2001 Available
[Online]

http://pcc.nps.navy.mil/Download/FMGuide_v3_r5.pdf
[f](#)

26. Weinman, Erin, *The United States Mint: A Model for Government E-business* Johns Hopkins University, October 29, 2000 Available [online]
<http://www.netcaucus.org/books/egov2001/pdf/CasesStud.pdf>

27. Grygo, Eugene "An IT makeover puts agency in Mint Condition" November 24, 2000 Available [Online]
<http://www.infoworld.com/articles/ca/xml/00/11/27/001127camentors.xml>

28. SAP, "Supporting Drawdown: Strategic Petroleum Reserve (SPR) Selects SAP Solution" *sapinfo.net* No. 74, September 2000 Available [Online]
<http://www.sap.info/resources/RFILE151603c6859c4c5044.pdf>

29. Harreld, Heather "Avoiding ERP Disaster", *Federal Computer Week*, May 29, 2000 Available [Online]
<http://www.fcw.com/fcw/articles/2000/0529/tec-erp-05-29-00.asp>

30. U.S. General Accounting Office, "Future Years Defense Program: How Savings From Reform Initiatives Affect DOD's 1999-2003 Program", Report: GAO/NSIAD-99-66, February 25, 1999.
31. U.S. General Accounting Office, "Defense Reform Initiative: Organization, Status, and Challenges", Report: GAO/NSAID-99-87, April 21, 1999
32. Berg, Robert M., and Fauntleroy, J. Corbin. A Brief History of Enterprise Resource Planning (ERP) Efforts in the Revolution in business Affairs (RBA), Center for Naval Analysis, Alexandria, VA October 1 1999
33. LaPuzza, Tom "SSC-SD Overview" May 2002 Available [Online]
http://www.spawar.navy.mil/sti/SSC_Overview/index.html#top)
34. LaPuzza, Tom, SSC San Diego Brief 2000 Available [Online]
<http://www.spawar.navy.mil/sti/publications/pubs/td/3105/td3105.pdf>
35. Department of Defense (DOD), *A Plan for Streamlining DOD's Science and Technology*,

Engineering, and Test and Evaluation Infrastructure: Report of the Section 907 and Section 912© Senior Steering Group for Review of the RDT&E Infrastructure, July, 1999

36. Naval Supply Systems Command, *How The Navy Working Capital Fund Works: A Graphical Overview* December 2001 Available [Online] <http://www.navsup.navy.mil/ORASearch.jsp>
37. Office of Secretary of Defense, *Defense Reform: Better Business Practices for the Business of Defense,* 2001 <http://www.defenselink.mil/dodreform/briefs/transplan2001.doc>
38. SSC San Diego "ERP Business Case Analysis-Revision 1" 30 June 2001.
39. Gartner Consulting Group, "ERP Business Case Analysis" May 14, 1999.
40. Volker, Randy email to Office of Secretary of Defense Comptroller [OSD(C)], FY2003 Budget Submission Justification, 1 July 2001.

41. Reason, Tim, "Federal Offences" CFO Magazine
March 2002
42. Youngwoo, Seo, "What is ERP?" April 27, 1999
Available [Online]
[http://wings.buffalo.edu/academic/department/som/
students/clubs/KMBA/work/mgs/ywerp/ywerp.htm](http://wings.buffalo.edu/academic/department/som/students/clubs/KMBA/work/mgs/ywerp/ywerp.htm)
43. Mountain-Scanners, "Work Sheet Study- Annual Cost
of Paper Record System" Available [Online]
[http://www.mountain-
scanners.com/pdfs/costperinch.pdf](http://www.mountain-scanners.com/pdfs/costperinch.pdf)
44. Jagannathan, Ravi, "Enterprise Resource Planning"
Available [Online]
<http://www.erpfans.com/erpfans/erpca.htm>
45. Hilmer, David "Should companies use best-of-breed
supply chain apps rather than buy these tools
from their ERP vendor?: Single Vendor Approach
Cuts Costs" Internetweek.com December 5, 2001
Available [Online]
[http://www.internetweek.com/graymatter/point12050
1.htm](http://www.internetweek.com/graymatter/point120501.htm)
46. Swartz, David and Orgill, Ken "Higher Education
ERP: Lessons Learned" November 2, 2001 Available
[Online]

<http://www.educause.edu/ir/library/pdf/eqm0121.pdf>

47. Koch, Christopher "The ABC's of ERP" February 7, 2002 Available [Online]
<http://www.cio.com/research/erp/edit/erpbasics.html>
48. Computerworld, "Top 10 Corporate Information Technology Failures" Available [Online]
<http://www.computerworld.com/computerworld/record/s/images/pdf/44NfailChart.pdf>
49. Peterson, William J., Gelman, Lisa, and Cooke, Dudley P. "ERP Trends" The Conference Board Research Report 1292-01-RR, June 2001
50. University of Canterbury Case Study "Gallery's Attempt at ERP" 2001 Available [Online]
http://www.mang.canterbury.ac.nz/courseinfo/msci/msci220/_vti_cnf/Exam%20Case%20Study%202002.pdf
51. Stedman, Craig, "Failed ERP Gamble Haunts Hershey" November 1, 1999 Available [Online]
<http://www.computerworld.com/news/1999/story/0,11280,37464,00.html>

52. McHugh, Josh, "Binge and Purge, Now we know: How software's promise died -- and who killed it." June 2000 Available [Online] <http://www.business2.com/articles/mag/0,1640,6580,FF.html>
53. LePree, Joy, "Think Big, Think Governance" April 8, 2002 Available [Online] <http://erp.ittoolbox.com/news/dispnews.asp?I=68918>
54. Carlo, Mike, "Implementing ERP Software: Enterprise Software Has To Fit Like A Good Suit" May 2002, Available [Online] <http://www.advancedmanufacturing.com/May02/erpsoftware.htm>
55. Melnyk, Steven A. Ph.D, OPIM and Stewart, Douglas M. Ph.D., "Managing Metrics" APICS-The Performance Advantage February 2001, Volume No.2 Available [Online] http://www.apics.org/Magazine/current_issue/metrics/full.asp
56. Sommer, Brian, "A New Kind Of Business Case" Optimize Magazine January 2002, Available [Online] <http://www.optimize.com/issue/003/roi.htm>

57. Chambers of Commerce. com Glossary "Chunking Principle" Available [Online]
<http://www.chambers.com.au/glossary/chunk.htm>
58. Koch, Christopher, "Why Doesn't Your ROI Add Up? You Do The Math" Darwin Magazine, March 2002, Available [Online]
http://www.darwinmag.com/read/030102/roi_content.html
59. Franklin, Curtis Jr., "The ABC's of ROI" April 29, 2002, Available [Online]
<http://www.networkcomputing.com/1309/1309ws1.html>
60. Bunham, Russ, and Rosenberg, Hillary, eCFO, September 15, 2001, Available [Online]
<http://www.cfo.com/Article?article=4918>
61. Mollison, Catlin "ROI" Internet World Magazine, March 1, 2002, Available [Online]
http://www.internetworld.com/magazine.php?inc=030102/03.01.02feature1_p1.html
62. Pallatto, John "Get The Most Out of ERP" Internet World Magazine, February 1, 2002, Available [Online]

<http://www.internetworld.com/magazine.php?inc=020102/02.01.02ebusiness1.html>

63. Hammer, Michael Ph.D., "How to Sell Change" Optimize Magazine, December 2001, Available [Online]
<http://www.optimizemag.com/issue/002/marketing.htm>
64. Prebil, Jim and Colbert, Tom, "IT Politics" CIO Magazine, February 15, 2002 Available [Online]
http://www.cio.com/archive/021502/re_politics.html
65. Person, David, "The Hidden Cost Of Data Integration" CIO Magazine, March 1, 1999, Available, [Online]
http://www.cio.com/archive/050199/cost_content.html
66. Zwiers, Joe, "Understanding The Total Cost of Software: How Hidden Costs Escalate in Software Deployments" Serverworld Magazine, March 2002, Available [Online]
<http://www.serverworldmagazine.com/monthly/2002/03/softwarecost.shtml>

67. Mueller, Bob "Profiles in IT: Standardizing Infrastructure Lowers Cost at Phillips" Available, [Online]
<http://www.esj.com/articles.asp?ID=1310283345AM>
68. Katz, David M., "Of Mice and Men: An ERP Case Study" March 21, 2001 Available [Online]
<http://www.cfo.com/Article?article=2348>
69. Cramm, Susan H., "Leadership Agenda: IT Economics" Available [Online]
<http://www.cfo.com/Article?article=2348>
70. Cosgrove-Ware, Lorraine, "Save Money: Centralize Your Help Desk" CIO Magazine, March 1, 2002 Available [Online]
http://www.cio.com/archive/030102/tl_numbers_content.html
71. Dash, Julekha, "The ROI of Training" March 18, 2002 Available [Online]
<http://www.computerworld.com/managementtopics/management/story/0,10801,69110,00.html>
72. Scarlet, Sarah D., and Berinato, Scott, "The ABC's of Security" Available [Online]
http://www.cio.com/security/edit/security_abc.html
1

73. Wallace, Thomas F., *ERP: Making It Happen, The Implementers' Guide to Success with Enterprise Resource Planning.* New York: Wiley, 2001
74. Booz, Allen, Hamilton, "Independent Third Party Assessment Report: and Space and Naval Warfare System Center San Diego Enterprise Resource Planning System" 10 April 2002
75. Price Waterhouse Coopers' website wcglobal website Available [Online]
<http://www.pwcglobal.com/>
76. Timmer, Doug, Reese, Tim, and Dorey, Kim. Teleconference brief of Northrop Grumman's ERP Lessons Learned 25 April 2002
77. Topacio, Helen. Interview 13 September 2002
78. Public Affairs, Office of the Secretary of Defense (OSD), "Contractor Team to Provide Plan for Financial Way Ahead" 9 April 2002 available [Online]
http://www.defenselink.mil/news/Apr2002/b04092002_bt170-02.html

INITIAL DISTRIBUTION LIST

1. Defense Technical Information Center
Ft. Belvoir, VA

2. Dudley Knox Library
Naval Postgraduate School
Monterey, CA

3. Lawrence R. Jones
Naval Postgraduate School
Monterey, CA

4. John Mutty
Naval Postgraduate School
Monterey, CA

5. Brad Naegle
Naval Postgraduate School
Monterey, CA

6. Commander
Space and Naval Warfare Systems Command
San Diego, CA

7. Commanding Officer
Space and Naval Warfare Systems Center
San Diego, CA