



Calhoun: The NPS Institutional Archive
DSpace Repository

Theses and Dissertations

1. Thesis and Dissertation Collection, all items

2017-12

Analysis of Navy Supply Corps lines of operation

Aurelio, Carnell P.

Monterey, California: Naval Postgraduate School

<https://hdl.handle.net/10945/56806>

This publication is a work of the U.S. Government as defined in Title 17, United States Code, Section 101. Copyright protection is not available for this work in the United States.

Downloaded from NPS Archive: Calhoun



Calhoun is the Naval Postgraduate School's public access digital repository for research materials and institutional publications created by the NPS community. Calhoun is named for Professor of Mathematics Guy K. Calhoun, NPS's first appointed -- and published -- scholarly author.

Dudley Knox Library / Naval Postgraduate School
411 Dyer Road / 1 University Circle
Monterey, California USA 93943

<http://www.nps.edu/library>



**NAVAL
POSTGRADUATE
SCHOOL**

MONTEREY, CALIFORNIA

MBA PROFESSIONAL REPORT

**ANALYSIS OF NAVY SUPPLY CORPS LINES
OF OPERATION**

December 2017

By: Carnell P. Aurelio

**Advisors: Geraldo Ferrer
Edward H. Powley**

Approved for public release. Distribution is unlimited.

THIS PAGE INTENTIONALLY LEFT BLANK

REPORT DOCUMENTATION PAGE			<i>Form Approved OMB No. 0704-0188</i>	
Public reporting burden for this collection of information is estimated to average 1 hour per response, including the time for reviewing instruction, searching existing data sources, gathering and maintaining the data needed, and completing and reviewing the collection of information. Send comments regarding this burden estimate or any other aspect of this collection of information, including suggestions for reducing this burden, to Washington headquarters Services, Directorate for Information Operations and Reports, 1215 Jefferson Davis Highway, Suite 1204, Arlington, VA 22202-4302, and to the Office of Management and Budget, Paperwork Reduction Project (0704-0188) Washington DC 20503.				
1. AGENCY USE ONLY (Leave blank)		2. REPORT DATE December 2017	3. REPORT TYPE AND DATES COVERED MBA professional report	
4. TITLE AND SUBTITLE ANALYSIS OF NAVY SUPPLY CORPS LINES OF OPERATION			5. FUNDING NUMBERS	
6. AUTHOR(S) Carnell P. Aurelio			8. PERFORMING ORGANIZATION REPORT NUMBER	
7. PERFORMING ORGANIZATION NAME(S) AND ADDRESS(ES) Naval Postgraduate School Monterey, CA 93943-5000			10. SPONSORING / MONITORING AGENCY REPORT NUMBER	
9. SPONSORING / MONITORING AGENCY NAME(S) AND ADDRESS(ES) N/A			11. SUPPLEMENTARY NOTES The views expressed in this thesis are those of the author and do not reflect the official policy or position of the Department of Defense or the U.S. Government. IRB number ____N/A____.	
12a. DISTRIBUTION / AVAILABILITY STATEMENT Approved for public release. Distribution is unlimited.			12b. DISTRIBUTION CODE	
13. ABSTRACT (maximum 200 words) The Navy Supply Corps delivers logistics to the Navy and joint warfighter through a broad range of capabilities, referred to as lines of operation, encompassing traditional logistics functions and valued business skills. The diverse skills give the Supply Corps a distinctive advantage as logistics officers. The purpose of this study is to examine the lines of operation to answer three research questions: What is a Supply Corps line of operation? What is the state of the current lines of operation? Where are there opportunities for improvements in the lines of operation? Logistics doctrine was compared, skill-coded billet distribution was analyzed, and promotion board preferences were examined. The findings supported the current categorization and billet distribution of lines of operation. However, there are a significant number of billets not aligned or coded to any skill, and some skills are highly desired by promotion boards but with little opportunity for experience. It is recommended that the Supply Corps examine the billet inventory to re-align or divest the numerous billets not aligned with a line of operation in order for the community to place and fully develop officers with the diverse professional skills required to effectively and efficiently support operations.				
14. SUBJECT TERMS Navy Supply Corps, supply, logistics, supply corps lines of operation			15. NUMBER OF PAGES 77	
			16. PRICE CODE	
17. SECURITY CLASSIFICATION OF REPORT Unclassified	18. SECURITY CLASSIFICATION OF THIS PAGE Unclassified	19. SECURITY CLASSIFICATION OF ABSTRACT Unclassified	20. LIMITATION OF ABSTRACT UU	

THIS PAGE INTENTIONALLY LEFT BLANK

Approved for public release. Distribution is unlimited.

ANALYSIS OF NAVY SUPPLY CORPS LINES OF OPERATION

Carnell P. Aurelio, Lieutenant Commander, United States Navy

Submitted in partial fulfillment of the requirements for the degree of

MASTER OF BUSINESS ADMINISTRATION

from the

**NAVAL POSTGRADUATE SCHOOL
December 2017**

Approved by: Geraldo Ferrer

Edward H. Powley

Rene G. Rendon
Academic Associate
Graduate School of Business and Public Policy

THIS PAGE INTENTIONALLY LEFT BLANK

ANALYSIS OF NAVY SUPPLY CORPS LINES OF OPERATION

ABSTRACT

The Navy Supply Corps delivers logistics to the Navy and joint warfighter through a broad range of capabilities, referred to as lines of operation, encompassing traditional logistics functions and valued business skills. The diverse skills give the Supply Corps a distinctive advantage as logistics officers. The purpose of this study is to examine the lines of operation to answer three research questions: What is a Supply Corps line of operation? What is the state of the current lines of operation? Where are there opportunities for improvements in the lines of operation? Logistics doctrine was compared, skill-coded billet distribution was analyzed, and promotion board preferences were examined. The findings supported the current categorization and billet distribution of lines of operation. However, there are a significant number of billets not aligned or coded to any skill, and some skills are highly desired by promotion boards but with little opportunity for experience. It is recommended that the Supply Corps examine the billet inventory to re-align or divest the numerous billets not aligned with a line of operation in order for the community to place and fully develop officers with the diverse professional skills required to effectively and efficiently support operations.

THIS PAGE INTENTIONALLY LEFT BLANK

TABLE OF CONTENTS

I.	INTRODUCTION.....	1
A.	BACKGROUND	1
B.	SCOPE	3
C.	RESEARCH QUESTIONS	3
D.	METHODOLOGY	3
1.	Literature Review	3
2.	Data Collection	4
3.	Data Analysis.....	5
4.	Summary.....	5
E.	CHAPTER OVERVIEW	6
II.	LITERATURE REVIEW	7
A.	SUPPLY CORPS 2040 STRATEGIC VISION STUDY	7
B.	LOGISTICS DOCTRINE AND GUIDANCE.....	11
1.	Joint Logistics.....	11
2.	Navy Logistics.....	13
3.	United States Marine Corps Logistics.....	15
4.	Army Logistics	17
5.	United States Air Force Logistics	19
6.	Department of Defense Logistics Human Capital Strategy	22
C.	LINES OF OPERATIONS IN COMMERCIAL BUSINESS.....	23
1.	Defining Lines of Operation.....	23
2.	Core Competencies and Capabilities	24
3.	Wal-Mart and Amazon Logistics	26
D.	LITERATURE REVIEW CONCLUSIONS	27
III.	DATA COLLECTION	29
A.	RESEARCH APPROACH.....	29
B.	METHOD	29
1.	Comparison of Logistics Functions	29
2.	Collection of Supply Corps Billet Distribution	30
3.	Collection of Recent Supply Corps Promotion Board Convening Orders.....	31
C.	SUMMARY	34
IV.	DATA ANALYSIS	35
A.	COMPARISON OF LINES OF OPERATIONS	35

1.	Supply Chain Management.....	35
2.	Acquisition Management.....	36
3.	Operational Logistics.....	37
4.	Comptroller and Financial Management	38
5.	Operations Research, Analysis, and Assessment	39
6.	Business Management	40
7.	Supply Corps Lines of Operation Summary	40
B.	CURRENT STATE OF LINES OF OPERATION	41
1.	Principal Lines of Operation.....	42
2.	Complementary Lines of Operation.....	43
3.	Lines of Operation Billet Distribution by Rank.....	43
C.	COMPARISON OF BILLET DISTRIBUTION AND DESIRED FUNCTIONAL SKILLS	46
D.	SUMMARY	47
V.	CONCLUSION	49
A.	LIMITATIONS	49
B.	WHAT IS A LINE OF OPERATION?.....	49
C.	WHAT IS THE STATE OF THE CURRENT SUPPLY CORPS LINES OF OPERATION?	50
D.	ARE THERE OPPORTUNITIES FOR IMPROVEMENTS IN THE LINES OF OPERATION?	51
1.	Realign Un-coded Shore Billets to Lines of Operation or Consider Divesting.....	52
2.	Further Research on Operational Logistics	52
3.	Synchronized and Consistent Messaging of Lines of Operation	53
4.	Re-evaluate Financial Management, Joint, Special Warfare, and Expeditionary Skills.....	53
E.	SUMMARY AND RECOMMENDATIONS.....	54
	LIST OF REFERENCES	55
	INITIAL DISTRIBUTION LIST	59

LIST OF FIGURES

Figure 1.	Navy Supply Corps Lines of Operation with Sub-specialty Codes. Adapted from NAVSUP (n.d.), NAVSUP (2010).....	9
Figure 2.	Core Logistics Functions. Source: JCS (2013, p. II-2).	12
Figure 3.	USN Logistics Core Functions. Adapted from DON (2001).....	14
Figure 4.	Marine Corps Four Logistics Processes. Source: USMC (1997, p. 46).	16
Figure 5.	USMC Core Logistics Functions. Adapted from USMC (1997).....	16
Figure 6.	U.S. Army Sustainment Capabilities. Source: DA (2012, p. iv).	18
Figure 7.	Air Force Agile Combat Support Overview. Source: USAF (2011).....	20
Figure 8.	HCS Workforce Competencies. Source: OSD (2008, p. 11).....	23
Figure 9.	Line of Operation, Operational Context. Source: JCS (2011, p. 105).	24
Figure 10.	LOO Distribution by Rank—2017.....	45
Figure 11.	Supply Corps Lines of Operation. Adapted from JCS (2011), NAVSUP (2010).....	50
Figure 12.	LOO Distribution by Coded Billet—2017.....	51

THIS PAGE INTENTIONALLY LEFT BLANK

LIST OF TABLES

Table 1.	USAF Logistics Readiness Officer Competencies and Proficiencies. Source: USAF (2017).	21
Table 2.	Comparing Lines of Operation to Doctrine	30
Table 3.	Consolidated O-4 Promotion Board Preferred Skills. Adapted from DON (2016c), DON (2017c).	32
Table 4.	Consolidated O-5 Promotion Board Preferred Skills. Adapted from DON (2016b), DON (2017b).	33
Table 5.	Consolidated O-6 Promotion Board Preferred Skills. Adapted from DON (2016a), DON (2017a).	33

THIS PAGE INTENTIONALLY LEFT BLANK

LIST OF ACRONYMS AND ABBREVIATIONS

ACS	Agile Combat Support
ADP	Army Doctrine Publication
AFDD	Air Force Doctrine Document
AFSC	Air Force Specialty Code
AQD	Additional Qualification Designator
BFM	Business Financial Management
CFETP	Career Field Education and Training Plan
DDT	Deployment, Distribution, and Transportation
DOD	Department of Defense
ECS	Expeditionary Combat Support
FM	Financial Management
FM	Field Manual
HCS	Department of Defense Logistics Human Capital Strategy
JCS	Joint Chiefs of Staff
LOO	Line of Operation
JP	Joint Publication
MCDP	Marine Corps Doctrinal Publication
MCWP	Marine Corps Warfighting Publication
NAVSUP	Navy Supply Systems Command
NDP	Navy Doctrine Publication
OPLOG	Operational Logistics
OPLOGOFF	Operational Logistics Officer
OA	Operations Analysis
OCS	Operational Contract Support
OR	Operations Research
OSD	Office of the Secretary of Defense
SCM	Supply Chain Management
USAF	United States Air Force
USMC	United States Marine Corps
USN	United States Navy

THIS PAGE INTENTIONALLY LEFT BLANK

ACKNOWLEDGMENTS

Sincere gratitude and appreciation to my advisors, the Thesis Processing Office, and library staff at the Naval Postgraduate School for their guidance and support. I would also like to thank the many wonderful professors and lecturers I have had the honor to learn from during my time here. Thank you to my wife, Samantha, and our three Cs, for your patience and resilience living a military life and for being my inspiration and motivation throughout my career. This project is dedicated to my mom, who lit up so many lives with her caring and giving spirit.

THIS PAGE INTENTIONALLY LEFT BLANK

I. INTRODUCTION

This research analyzes the lines of operation for the Navy Supply Corps. The lines of operation serve as the core functions of the Supply Corps. Operational Logistics (OPLOG) is a principal (essential) line of operation for the Navy Supply Corps along with Supply Chain Management (SCM) and Acquisition Management. The Supply Corps identifies three complementary (non-essential but skill enhancing) lines of operation: Comptroller and Financial Management, Business Management, and Operations Research (OR) (Naval Supply Systems Command [NAVSUP], 2010). However, there is little guidance on what differentiates a principal line of operation from a complementary line of operation. Principal lines of operation are important in defining and developing the skill sets, training and billets that Supply Corps officers will focus on in order to ensure that the Supply Corps is providing the required logistics capabilities to support the Fleet and Joint Warfighter. Potentially, career and promotion opportunities are based on whether or not an officer has experience in a principal line of operation. Due to this relevance, the Supply Corps would benefit from an analysis that reviews what constitutes a Supply Corps line of operation and how current skill sets and experience opportunities map to the needs of the Supply Corps and Navy. The results of this study could be used in part to shape Supply Corps community messaging to Junior Officers as well as selection board members. This study provides amplifying justification for Supply Corps lines of operation through comparative analysis of military doctrine and commercial businesses. Furthermore, this study examines the current distribution of billets for respective lines of operation, along with recent promotion board preferences for skills, for the current state of lines of operation and opportunities for improvement.

A. BACKGROUND

The Supply Corps 2040 Strategic Vision Study (NAVSUP, 2010) broadly labeled OPLOG as a line of operation for the Supply Corps, joining SCM and Acquisition Management as principal lines of operation. However, there is ambiguity as to what constitutes a principal line of operation vice a complementary (skill enhancing) line of

operation. Presumably, principal lines of operation are important in defining and developing the skill sets, training, and billets that Supply Corps officers will focus on in order to ensure that the Navy Supply Corps is providing effective logistics capabilities to support the Fleet and Joint Warfighter. Potentially, careers and promotion opportunities are based on whether or not an officer has experience in a principal line of operation. In the private business sector, organizations do not use the term *lines of operation* but may use the terms core capabilities, key functions, or competencies to describe the primary means of delivering their product or service. However, definitions and terms begin to muddle what constitutes the *what* and the *how* regarding an organization's main functions. The same can be said for the Supply Corps and their distinction of principal and complementary lines of operation, core competencies, key skills, and key support functions.

Furthermore, the definition of OPLOG as it pertains to a line of operation is just as ambiguous. Since the Strategic Vision Study, OPLOG was comprised of the following sub-specialties: Operations Research Analysis, Operations Research Analysis – Logistics, Operations Research Analysis – Energy, Operational Planning, Transportation Management, and Special Warfare (Office of Supply Corps Personnel, 2011). The recent creation of the Additional Qualification Designator (AQD) 9L1/2, OPLOG Officer, has helped frame how an officer earns credit for OPLOG experience but has likely changed the current distribution of billets classified as OPLOG (Navy Personnel Command, 2017). There are no guidelines or framework that justify why OPLOG is or is not a primary line of operation, or for that matter why Acquisition and SCM are primary lines of operation. Nor is there a framework that can reassess currently labeled complementary lines of operation as customer requirements change in the future. The Supply Corps community would benefit from an analysis that further defines a Supply Corps line of operation and evaluates the presently identified lines of operation, as well as opportunities for improvement.

B. SCOPE

This research provides a graduate level analysis from the perspective of a Junior-grade officer and does not intend to discount previous research on this topic, and certainly not senior leader collaborations on the matter. Rather, this study adds to the miniscule academic literature on Navy Supply Corps lines of operation for future analysis. The results of this study will help shape Supply Corps community messaging to junior officers as well as selection board members and provide a clearer understanding of Supply Corps lines of operation to the community. Additionally, this research identifies areas of capability strength as well as capability gaps that can be improved.

C. RESEARCH QUESTIONS

Clearly defined lines of operation can provide the Supply Corps community a sense of direction as to what jobs and skills to focus on to best support the Fleet and joint warfighter. For Junior Officers, principal lines of operation can greatly affect career track and milestone decisions for promotion. Any ambiguity or confusion on lines of operation can not only have a detrimental outcome to a Supply Corps officer's career, but focusing on irrelevant and mislabeled lines of operation (and their associated training) can degrade the logistics support from the Supply Corps to the Fleet.

This research seeks to provide further justification and evaluation to the following research questions:

1. What is a Supply Corps line of operation?
2. What is the state of the current Supply Corps lines of operation?
3. Are there opportunities for improvements in the lines of operation?

D. METHODOLOGY

1. Literature Review

In order to define what a line of operation is, this study first identifies the desired end state or goal for the Navy overall and the Supply Corps role in that mission. The 2017-2021 Navy Supply Systems Command (NAVSUP) Strategic Plan's stated mission

is “to provide supplies, services, and quality of life support to the Navy & Joint warfighter” (Naval Supply Systems Command, n.d., p. 5). Theoretically, the Supply Corps’ principal lines of operation should significantly contribute to those objectives and reflect the primary functions of Supply Corps officers to meet those objectives. The Supply Corps 2040 Strategic Vision Study defined principal lines of operation as “primary functional areas” (NAVSUP, 2010, p. 78) while complementary lines of operation as “secondary functional areas within the Supply Corps that support the principal lines (of operation)” (NAVSUP, 2010, p. 76). However, there is little criteria as to what constitutes a principal line of operation vice a complementary line of operation, and no analysis of lines of operation since 2010. A review of service and military doctrine can give perspective on what constitutes a line of operation for other services to support the warfighter. Additionally, the logistics of Wal-Mart and Amazon will be reviewed for a commercial business perspective on key capabilities and key logistics functions.

2. Data Collection

This study reviews current billet distribution that show what lines of operation and skills are most prevalent and required for Supply Corps officers. The Navy designates applicable billets with AQDs and/or sub-specialty codes to communicate the experience required or attained for certain tours. In 2010, 32% of shore billets fell under the SCM line of operation, 15.5% fell under the Acquisition line of operation, and 8.7% were listed under the OPLOG line of operation. Interestingly, 9.3% were coded as complementary lines of operation, and 8.4% of shore billets were un-coded and designated as staff/general supply (NAVSUP, 2010, p. 40). A review and comparison to current billet coding distribution will capture the valued skills and experience for the Supply Corps present day, and show any changes or opportunities for improvement since 2010. Furthermore, a recent change in the billet classification for OPLOG billets is considered for its impact on the distribution of OPLOG billets across all Supply Corps jobs.

Finally, a review of the FY17 and FY18 Staff Officer Promotion Board Convening Orders for the ranks of O-4 – O-6 was performed. The convening orders list valued skills for each community to be given strong consideration for promotion. Though not the sole basis for promotion, these specified skills provide qualitative data on what skills are of priority for the Supply Corps.

3. Data Analysis

Supply Corps lines of operations are compared to other services and commercial business. The quantitative data (billet distribution) and qualitative data (promotion board convening orders) are analyzed for current distribution of billets by lines of operation and areas to improve based on prioritized skills and billet opportunities.

4. Summary

The study focuses on the following methods to answer the research questions:

- Comparison of Logistics Functions. A comparison of joint, service, and commercial business logistics functions provides amplifying context and perspective for what constitutes a Supply Corps lines of operation.
- Supply Corps Billet Distribution Analysis. An analysis of Supply Corps billet distribution by sub-specialty codes provides a snapshot of the broad spectrum of job skills that Supply Corps Officers are currently performing and how many billets are focused on a particular line of operation or none at all. The Strategic Vision Study and today's billet distribution are compared. A deeper analysis of sub-specialty codes by rank provides perspective on valued skills required for leadership and key billets.
- Recent selection board convening orders are evaluated for consistent messaging of valued Supply Corps skills compared to principal and complementary lines of operation.

There are two desired products from this research:

- A comparative analysis that substantiates Supply Corps lines of operation.

- A comparison of the current state of lines of operation by billets across the fleet and the prioritized skills of the Supply Corps per promotion board data.

The hypothesis is that compared to other services, Supply Corps officers possess the most diverse skill-set to support the warfighter. Acquisition, SCM and OPLOG are principal lines of operation consistent with doctrinal core logistics functions required for the Supply Corps to provide efficient and effective service to the Fleet and joint war fighter. However, there is a slight disconnect between what skills are *principal* and what skills are *priority*. The skill-coded distribution of billets will identify a gap in opportunity for the Supply Corps to provide and enhance OPLOG skills. Complementary lines of operation, such as comptroller and operational analysis, will display a high priority but low opportunity.

E. CHAPTER OVERVIEW

Chapter I introduces the topic and discusses the research questions. Chapter II discusses literature review and provides a detailed outline of the direction of the study. Chapter III discusses the data collection to include sources of the data used in this study. Chapter IV explains the data analysis as we examine the current distribution of billets by skill code, as well as implications from the promotion board convening orders. Finally, Chapter V details the limitations, answers the research questions, and provides recommendations for future research.

II. LITERATURE REVIEW

One of the main components of this research study is an analysis and comparison of logistics doctrine across military services, as well as common practices in private organizations regarding core business functions. This literature review lays the foundation of the logistics doctrine and associated references before a more detailed comparison in Chapter IV. The focus of this literature review is comprised of three parts. First, current guidance from the Navy Supply Corps is examined which provides background and perspective on lines of operation. Second, a review of joint and military logistics publications and guidance is conducted. This study does not compare or detail the different logistic command structures of each service, nor does it analyze the various commanders' guidance or operational support concepts for logistics. This research is also not a comparative analysis of each service's theories on logistic support. Although those topics very much influence each service's primary lines of operation, this research takes an as-is snapshot of each service's core logistics functions, focusing on the *what*, and not the *why*, to observe similarities, differences, and opportunities for improvement for the Supply Corps. Finally, the study examines private business practices in determining core capabilities, competencies, and logistics function and organization in two successful companies.

A. SUPPLY CORPS 2040 STRATEGIC VISION STUDY

The inspiration for this research is the Supply Corps 2040 Strategic Vision Study. Promulgated in 2010 it was the Supply Corps' second strategic planning effort following the first strategic vision document in 1989 and was accomplished by a robust collaboration between active duty, reserve, and retired Supply Corps Officers (NAVSUP, 2010). In addition, the Strategic Vision Study (NAVSUP, 2010) used a Senior Leadership Advisory Council, conducted surveys, and analyzed executive level correspondence with Supply Corps and unrestricted line officers, rank O-6 and above across a diverse range of commands to gather insight on the demand and value of the Supply Corps and its competencies. The Strategic Vision Study lays out the Supply Corps' core competencies

and traits that are vital for near-term and future success, and it validates today's primary lines of operation: Acquisition, Supply Chain Management, and Operational Logistics; and complementary lines of operation: Comptroller and Financial Management, OR, Business Management (NAVSUP, 2010, p. 8). These lines of operation are compared and contrasted throughout the rest of this study against other services, guidance, and other literature on core competencies. Figure 1 shows the Supply Corps lines of operation and their respective capabilities and billet sub-specialty codes.

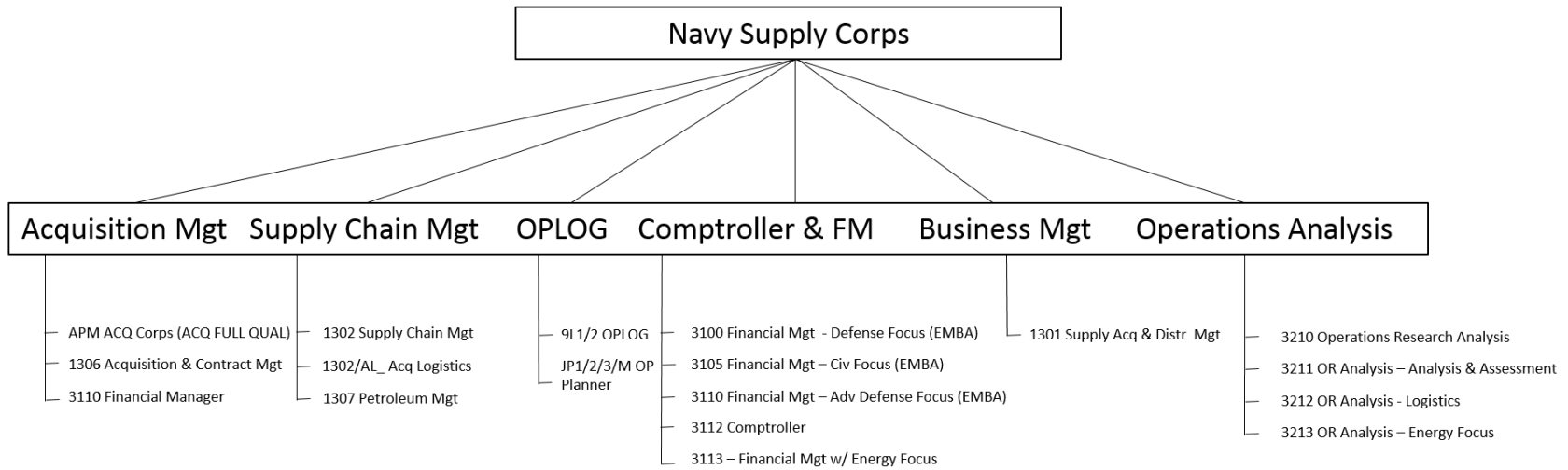

Figure 1. Navy Supply Corps Lines of Operation with Sub-specialty Codes. Adapted from NAVSUP (n.d.), NAVSUP (2010).

The Supply Corps Strategic Vision Study defines the Supply Corps' lines of operations as "the primary and complementary functional areas that represent base skills of the Supply Corps" (NAVSUP, 2010, p. 77). Additionally, its definition of core competencies identifies strategic activities that comprise the skills, resources and knowledge that give the Supply Corps its competitive advantage over its competition. The core competencies of the Supply Corps identified by the Strategic Vision Study are: Developing Autonomous, Accountable and Resourceful Leaders and Managers; Operational Unit Support; Business Acumen; Broad Skill Training and Experience; Professional Networks (NAVSUP, 2010, p. 59). This study also compares the Supply Corps' core competencies with that of other services, doctrine, and literature.

The AQD 9L1/9L2 have been established and provide guidance to better track, identify, and detail those officers that have OPLOG and experience (Navy Personnel Command, 2017, p. 665). AQD's are a way to designate certain billets that provide or require experience in a specific function such as OPLOG, Acquisition, and Joint. However, in order to receive the AQD 9L1/9L2, Supply Corps officers must apply for the designation based on criteria outlined in Volume 1, Part D of the Manual of Navy Officer Manpower and Personnel Classification (Navy Personnel Command, 2017, p. 665). The listed criteria may be more specific and restrictive than the previous determination of OPLOG billets, and therefore might shift sub-specialty codes and AQDs previously categorized as OPLOG into a complementary line of operation category. The realignment may also affect the billet distribution and overall opportunities in the OPLOG line of operation. Additionally, since the 9L1/2 AQDs are nominative (an officer must submit a nomination package that must be approved in order to obtain the AQD) and not specifically tied to designated billets, there is potential that the community may lose ideal visibility of the true distribution of OPLOG billets, and their impacts, across the fleet.

B. LOGISTICS DOCTRINE AND GUIDANCE

1. Joint Logistics

Joint Publication (JP) 4-0 is the guiding doctrine for Joint Logistics Operations and defines seven core logistics capabilities as: deployment and distribution, supply, maintenance, logistics services, operational contract support (OCS), engineering, and health services, as listed in Figure 2 (Joint Chiefs of Staff [JCS], 2013, p. 30). Of note, the context of core logistics functions in JP 4-0 is while conducting joint operations with two or more services. Looking deeper at the core functions, deployment and distribution is considered the cornerstone of all logistics functions (JCS, 2013, p. 30). JP 4-0 notes that the Defense Logistics Agency (DLA) is the main supplier of commodities and services. The logistics function of maintenance includes both depot level as well as field level maintenance. Logistics services are highly scalable and disparate capabilities and can include services such as food service, water and ice service, contingency base services, hygiene services, and mortuary affairs (JCS, 2013, p. 31). Interestingly, OCS is identified as a core logistics capability separate from standard identification of acquisition or contracting, and in fact, has its own guidance, JP 4-10, “Operational Contracting Support.” Finally, JP 4-0 identifies Health Services as a core logistics capability “to improve the health readiness of individual personnel as well as the overall force and provide HS in order to ensure mission accomplishment” (JCS, 2013, p. 13).

Core Logistics Functions

Core Functions	Functional Capabilities
Deployment and Distribution	<ul style="list-style-type: none"> • Move the force • Sustain the force
Supply	<ul style="list-style-type: none"> • Manage supplies and equipment • Inventory management • Manage global supplier networks • Assess global requirements, resources, capabilities, and risks
Maintenance	<ul style="list-style-type: none"> • Depot maintenance operations • Field maintenance operations
Logistics Services	<ul style="list-style-type: none"> • Food service • Water and ice service • Contingency base services • Base and installations support • Hygiene services
Operational Contract Support	<ul style="list-style-type: none"> • Contract support integration • Contractor management
Engineering	<ul style="list-style-type: none"> • General engineering • Combat engineering • Geospatial engineering
Health Services	<ul style="list-style-type: none"> • Health service delivery • Force health protection • Health system support

Figure 2. Core Logistics Functions. Source: JCS (2013, p. II-2).

Absent from any designation of core logistics capabilities by JP 4-0 is OPLOG or an equivalent planning capability. Also not mentioned in the joint doctrine are logistic lines of operation. JP 4-0 does recognize that “Logistics includes planning and executing the movement and support of forces” (JCS, 2013, p. 19). On the roles of Joint Logisticians they “Plan, supervise, execute, synchronize, and coordinate core joint logistic functions” (JCS, 2013, p. 20). Therefore, it could be argued that OPLOG Planning—though not specified by JP 4-0 as a core logistics capability—is very much critical to the success of logistics efforts since it converges the logistics capabilities

across the operating environment to enable mission success. Whether that is a primary or complementary line of operation is discussed in Chapter IV.

2. Navy Logistics

A review of the United States Navy (USN) doctrine on logistic support, Naval Doctrine Publication (NDP) 4, *Naval Logistics*, offers insight on the service's principles and core capabilities to support the warfighter. It identifies six major logistics functional areas: supply, maintenance, transportation, engineering, health services, and other logistics services (Department of the Navy [DON], 2001, p. 9). Figure 3 depicts the USN core logistics functions. Supply encompasses the provision of goods/material and services for the forces. It is a robust functional area, consisting of the “design, procurement, contracting, receipt, safe storage, inventory control, issuance, retrograde, and disposal of end items including repairables and consumables” (DON, 2001, p. 9). While Supply seems to capture the acquisition and inventory management processes, Maintenance, the second functional area, focuses on actions to “preserve, repair, and ensure continued operation and effectiveness of systems, components, and equipment” (DON, 2001, p. 9). Transportation involves not only the movement of personnel for deployment and redeployment, but also intra-theater during deployment as well as the movement of supplies for sustainment. The next major functional area, Engineering, includes construction and repairs in both combat and shore facilities and their maintenance. Health Services is the typical medical and dental support, including the facilities and materials, to personnel—in both combat and non-combat environments—and their family members. Finally, NDP 4 categorizes Other Logistics Services, which are pertinent for personnel support, quality of life, and morale. Such services include billeting, disbursing, Exchange and Barber, Laundry and Ship's store services, food services, Morale Welfare and Recreation (MWR), Mortuary Affairs, and Postal Services. (DON, 2001).

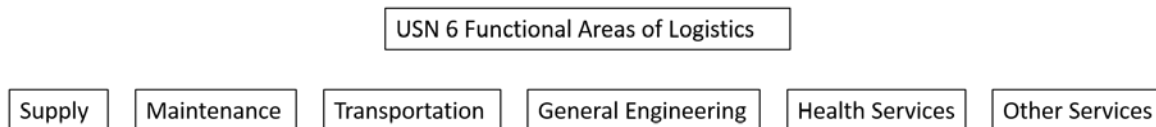

Figure 3. USN Logistics Core Functions. Adapted from DON (2001).

In addition to identifying the six major logistics functions, NDP 4 also describes Process Elements, which classifies all logistics process activities. The four Process Elements are: Acquisition, Distribution, Sustainment, and Disposition. Acquisition consists of “procuring, producing, or constructing commodities, facilities, ordnance, and major weapon systems and end items” (DON, 2001, pp. 17-18). Distribution “refers to the processes used to get materiel, services, and personnel to the supported forces,” which includes the management and control of inventory (DON, 2001, p. 18). Sustainment “is the provision of personnel, logistics, and other support required to maintain operations” (DON, 2001, p. 19). Finally, Disposition is “the handling, stowage, retrograde, and disposal of materiel and resources released or returned by forces” (DON, 2001, p. 19). These Process Elements, though not labeled as functions, encompass the typical processes in a cradle-to-grave logistics perspective.

OPLOG as a function and not as an operating environment, is not classified by NDP 4 as a major logistics function. Furthermore, logistic lines of operation are not referenced in the publication either. Logistics planning along with logistics information support helps provide operational readiness throughout a continuously changing and dynamic environment. Logistics Planning is labeled as complementary to supporting the commander, and it enables the course of action selection and adaptation to changing environments (DON, 2001, pp. 27-28). Still, logistics planning and its products can be considered a force multiplier and integral towards the confidence of the commander, as demonstrated by NDP 4 having an entire chapter designated for Naval Logistics Planning, which seems to underscore its importance in the execution of providing logistics to the warfighter.

3. United States Marine Corps Logistics

Of note, NDP 4 provides guidance for both Navy and Marine logistics, but more specific to U.S. Marine Corps (USMC) logistics are Marine Corps Doctrine Publication (MCDP) 4, *Logistics*; Marine Corps Warfighting Publication (MCWP) 4-1, *Logistics Operations*; MCWP 4-11, *Tactical Level Logistics*; and MCWP 4-12, *Operational Level Logistics*. Since the MCWP 4- series all expand on the MCDP 4 and are built on its guidance on logistics, this research only focuses on the MCDP 4's higher-level perspective on core logistics functions. The MCDP 4 promulgates guidance on supporting the force in a complex and dynamic operating environment by providing the resources and sustainment to the commander to win the battle. Broadly, MCDP 4 describes the logistics process as being comprised of four steps: acquisition, distribution, sustainment, and disposition (U.S. Marine Corps [USMC], 1997, p. 45). Refer to Figure 4. Acquisition includes procurement at the strategic, operational, and tactical levels of a range of items such as weapons, equipment, parts, and commodities. Distribution encompasses transportation of material and people to the battlefield, while also maintaining inventory and control procedures. The support of operational missions until completed is enabled by logistics Sustainment via maintenance, supply chains, and other services. Finally, Disposition is the process of consuming or retrograding the equipment for repair, re-use, salvage, or disposal (USMC, 1997, pp. 45–47).

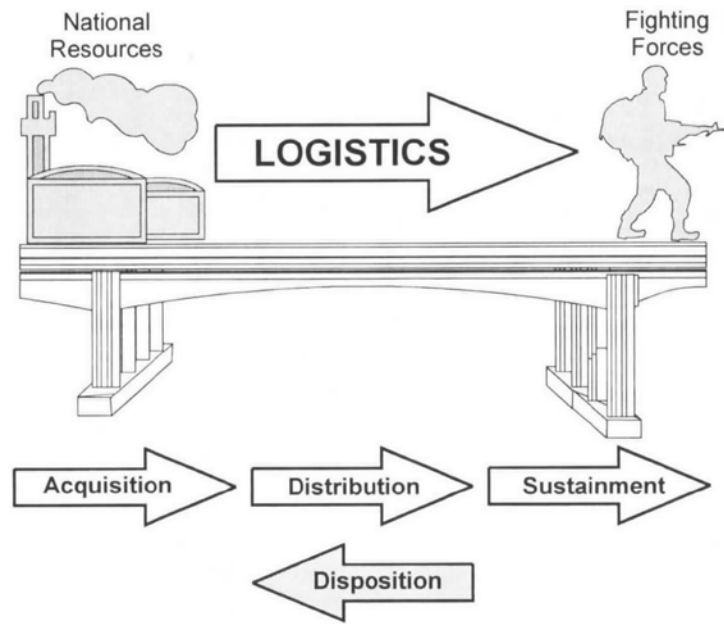

Figure 4. Marine Corps Four Logistics Processes. Source: USMC (1997, p. 46).

MCDP 4 outlines six major functional areas of logistics: supply, maintenance, transportation, general engineering, health services, and other services (USMC, 1997, p. 47). See Figure 5. These functional areas match those in the NDP 4. MCDP 4 states to be most effective in supporting operations, each functional area should not be planned separately. Rather, planning all functional areas should be integrated and synched into the overall logistics support system and process (USMC, 1997, p. 48).

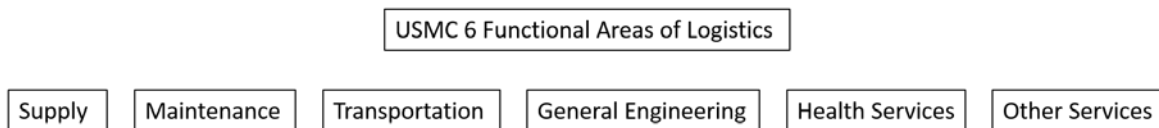

Figure 5. USMC Core Logistics Functions. Adapted from USMC (1997).

OPLOG is discussed in MCDP 4, not as a logistics function or competency, but primarily as logistics support at different levels of war (along with strategic and tactical) that has its own unique considerations and role in supporting the operational mission. It is not just differentiated by its size and scope of support compared to strategic or tactical

logistics. It is the link between strategic level logistics and tactical level logistics, sustaining operations by managing and utilizing resources from strategic level logistics and providing those resources to the strategic level. Developing logistics plans, interpreting commander's intent, and having a high performing logistics command and control system are key to success (USMC, 1997).

No mention of lines of operation is made in MCDP 4. Also absent from key logistics functions is planning. Similar to Navy logistics doctrine, the importance of planning is underscored throughout the document. "Commanders must plan for and supervise the process of acquisition, distribution, sustainment, and disposition to ensure that logistics supports, not inhibits, their operational designs" (USMC, 1997, p. 47). MCDP 4 suggest planning is more than a complementary skills, rather,

Planning is crucial to all military activities, but it is essential to the effective conduct of logistics, given the quantity and variety of resources to be provided, the diverse nature of the logistics requirements to be satisfied, and the impact of time-distance factors on the provision of timely support. (USMC, 1997, p. 68)

4. Army Logistics

The Army Doctrine Publication (ADP) No. 4-0, *Sustainment*, is the foundation for which the Army uses to plan sustainment for operational missions. For the Army, Sustainment consists of three elements: logistics, personnel services, and health service support (Department of the Army [DA], 2012, p. 1). Each of these elements, in turn, has their own components, see Figure 6.

ADP 4-0 (DA, 2012) categorizes maintenance, transportation, supply, OCS, field services, distribution, and general engineering support as components of logistics, and defines logistics as

Planning and executing of the movement and support of forces. It includes those aspects of military operations that deal with: design and development; acquisition, storage, movement, distribution, maintenance, and disposition of materiel; acquisition or construction, maintenance, operation, and disposition of facilities; and acquisition or furnishing of services. (DA, 2012, p. 1)

Personnel Services is an element of Army sustainment, and is similar to the Navy’s *Other Logistics Functions*. It encompasses services for the morale and welfare of personnel, but still has its own unique associated functions. Human resources support, financial management operations, legal support, religious and band support are the major functional areas of Personnel Services for Army sustainment (DA, 2012, p. 2). Personnel Services, though important for morale, do not seem to be as directly involved in operational support as logistics.

The final element of Army sustainment is health service support which “promote, improve, conserve or restore the mental and physical well-being” of not only Army personnel, but also their families and other services or agencies as directed (DA, 2012, p. 2). Of importance is that health service support can be conducted in combat operations and at home station. Health service support functions include casualty care (includes hospital care, dental, laboratory, mental/psychiatric care, and chemical biological warfare treatment), medical evacuation, and medical logistics (DA, 2012, pp. 2–3). This project will not delve deeper into health service or medical logistics functions.

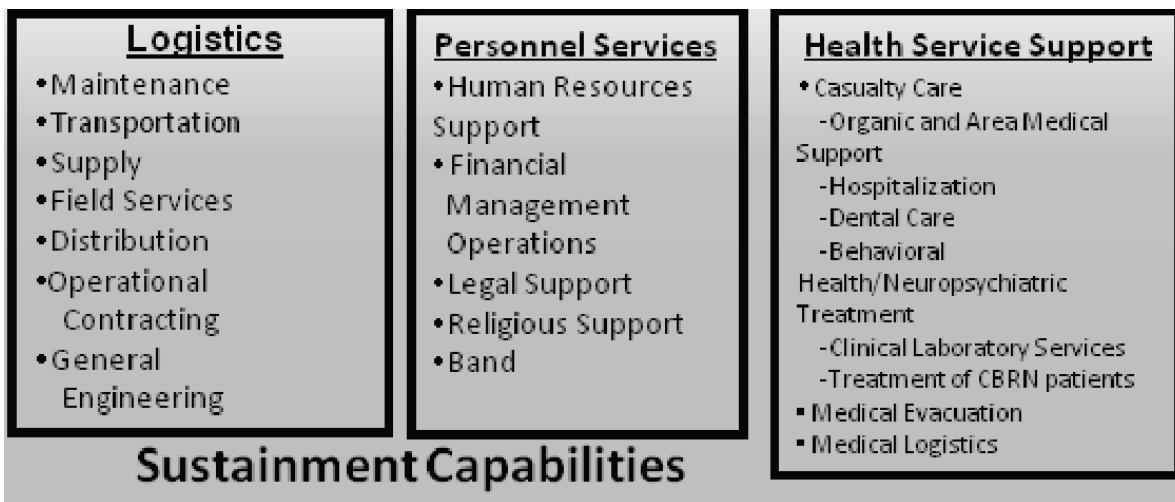

Figure 6. U.S. Army Sustainment Capabilities. Source: DA (2012, p. iv).

ADP 4-0 does not reference OPLOG or logistic lines of operation. However, it does suggest the importance of sustainment planning towards the accomplishment of mission success. Close coordination and synchronization by sustainment planning staff and the operational staff is necessary. Finally, the importance of sustainment planning is that “a successful sustainment plan will extend operational reach, prevent culmination or loss of the initiative, manage transitions, exploit possible opportunities, and mitigate risk” (DA, 2012, p. 11).

While ADP 4-0 covers overarching sustainment concepts for the Army, several Field Manuals (FM) have been promulgated giving more specific guidance for various sustainment categories. FM 4-95 provides even more details for Logistics Operations, FM 4-40 gives guidance for Quartermaster Organizations to include Supply and Field Service Operations, FM 4-01 discusses Army Transportation, FM4-02 Army Health System, and FM 4-30 Ordnance Operations. Since the intent of this research is to compare primary lines of operation of the Navy Supply Corps to their sister service’s equivalent, this study does not delve into doctrinal FMs but instead focuses on the Army’s overall concept of sustainment and to a lesser extent its classification of primary logistic functions.

5. United States Air Force Logistics

The U.S. Air Force’s (USAF) guiding doctrine for logistics is included in Air Force Doctrine Document (AFDD) 4-0, Combat Support. AFDD 4-0 captures the logistics role in supporting combat forces, but also the full range of support functions for Agile Combat Support (ACS) and Expeditionary Combat Support (ECS) operations. In total, 26 functional areas (see Figure 7) comprise ACS and all work cross-functionally and synchronized to “generate combat capability by creating, posturing, bedding down, protecting, servicing, maintaining, and sustaining support and operational forces” (U.S. Air Force [USAF], 2011, p. 4). AFDD 4-0 (USAF, 2011) does not prioritize or cull out specific logistic areas that are more pertinent to completing the mission, but instead suggests that all functional areas should work in tandem across the spectrum of creating forces, deployment, sustainment, and redeployment.

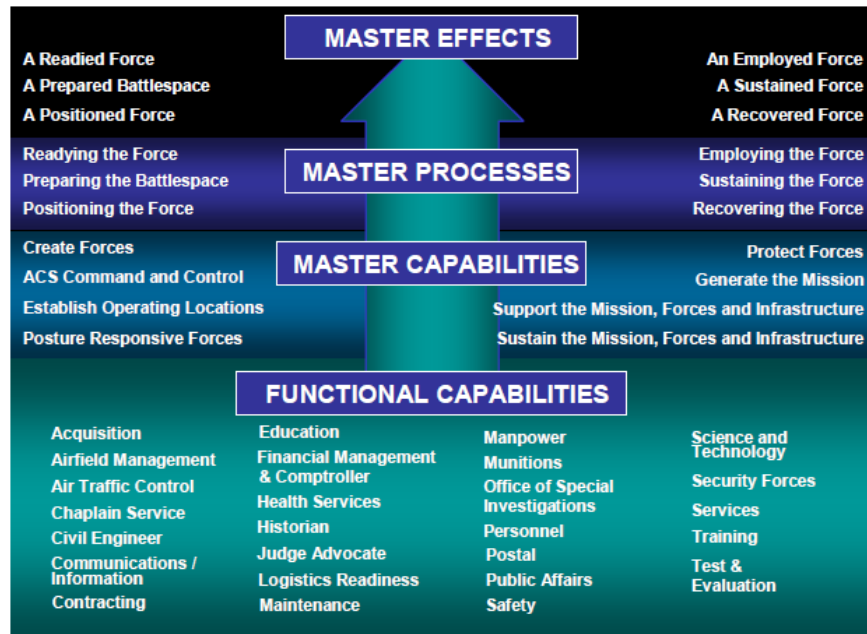

Figure 7. Air Force Agile Combat Support Overview. Source: USAF (2011).

Further research into USAF logistics found a more detailed view on logistics in the Career Field Education and Training Plan (CFETP) for Logistics Readiness Officers. USAF Logistics Readiness Officers, designated by Air Force Specialty Code (AFSC) 21RX, career progression and training align with two primary competency areas – Supply Management, and Deployment, Distribution, and Transportation (DDT) – and their respective proficiencies (USAF, 2017, p. 7). See Table 1. Supply Management proficiencies include: supply, vehicle management, fuels, and life cycle logistics. The supply proficiency is similar to Navy supply chain management and inventory management. DDT proficiencies include: transportation (ground or air), and logistics planning (USAF, 2017, p. 7).

Table 1. USAF Logistics Readiness Officer Competencies and Proficiencies.
Source: USAF (2017).

COMPETENCIES	Supply Management	Deployment, Distribution and Transportation (DDT)
PROFICIENCIES	Supply Vehicle Management Fuels Life Cycle Logistics	Transportation (Ground or Air) Logistics Plans

The USAF Logistics Readiness Officer career track encourages a broad experience base among the primary competencies and their proficiencies. In addition to training courses, an officer grade O-1 – O-3 expecting to complete the first of three levels of skill certification should aim to obtain “48 months experience in at least three (No less than 12 months in each) of the five proficiencies (Supply, Transportation (Ground or Air), Vehicle Management, Logistics Plans, and Fuels); and completed requirements for both Competencies (Supply Management and DDT)” (USAF, 2017, p. 10). This career track suggests the USAF produces logistics officers with a range of experience in Supply Management and DDT. Additionally, Senior Level and Master Level Skill certifications require 7 and 15 years, respectively, in the logistics readiness officer field (USAF, 2017, p. 10).

Interestingly, the Air Force does in fact recognize and distinguishes logistics planning as one of the five proficiency skills for logistics, with training and experience built into their Logistics Readiness Officer career track (USAF, 2017, p. 9). Neither the AFDD 4-0 nor the CFETP make note of logistics lines of operation. Finally, though acquisition is listed as one of twenty-six functional areas of combat support, it is not part of the USAF Logistics Readiness Officer career track, showing the USAF draws a distinct separation between their logistics and acquisition career fields.

6. Department of Defense Logistics Human Capital Strategy

Promulgated in 2008, the Department of Defense, Logistics Human Capital Strategy (HCS) (Office of the Secretary of Defense [OSD], 2008) outlines a foundation for the logistics workforce, human resource practices, and culture in the future that is comprised of logisticians able to succeed in a joint operating environment due to their interchangeability of common competencies. At the heart of the HCS is “competency-based management of the DOD’s logistics workforce, manifest in the creation of a logistics career roadmap with a common lexicon and set of core logistics competencies and proficiencies” (OSD, 2008, p. 6). With its intent to essentially train and have available a pool of logisticians with the same overarching core logistics competencies across services, a review of those core competencies benefits this study. Identified and listed in Figure 8 are four primary technical workforce categories: Supply Management; Deployment/Distribution/Transportation; Maintenance Support; Life Cycle Logistics. These four levels of technical workforce categories are comprised of fifteen competencies (OSD, 2008, p. 8). There is no mention of lines of operation in the HCS, or of OPLOG. However, supply planning and distribution planning are listed as technical workforce competencies. Acquisition is included in the Life Cycle Logistics technical workforce category, but not specifically as contracting and procurement, instead as “design, develop, test, produce and deploy” in the system’s life cycle (OSD, 2008, p. 11). The fact that OSD values the skills of supply planning enough to include that capability into the desired competencies of its workforce is significant.

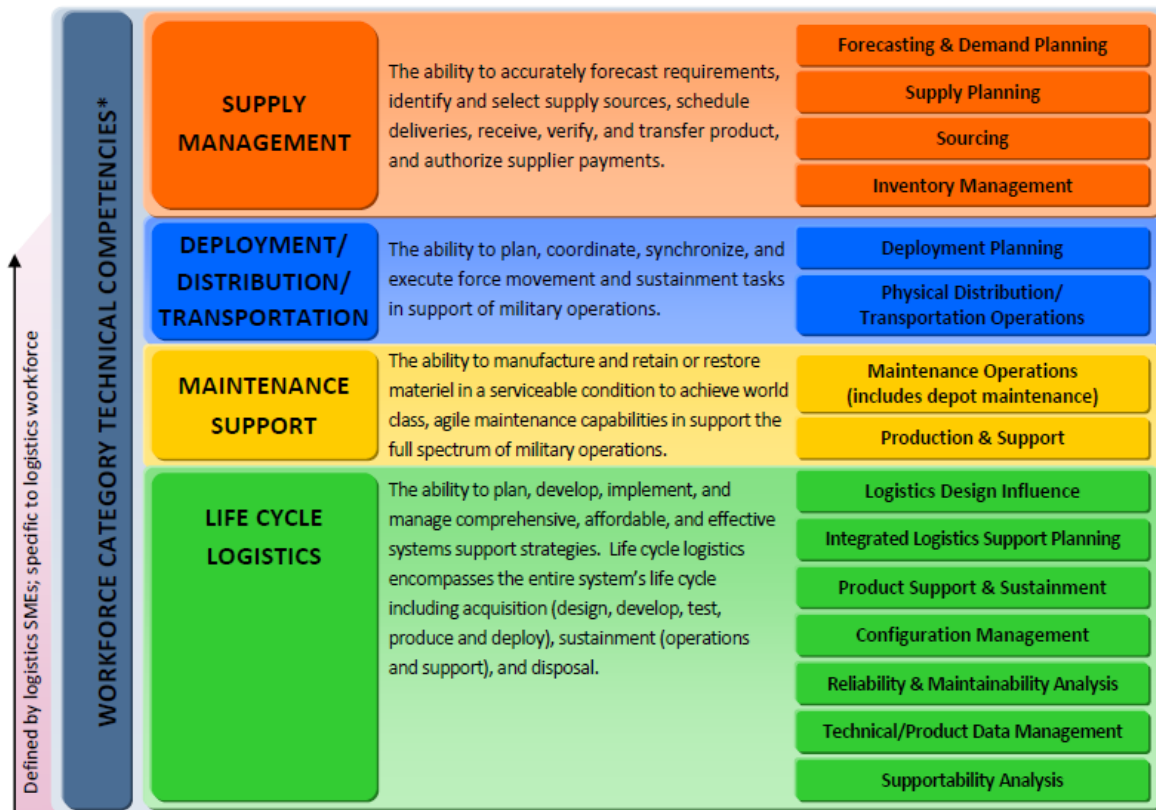

Figure 8. HCS Workforce Competencies. Source: OSD (2008, p. 11).

C. LINES OF OPERATIONS IN COMMERCIAL BUSINESS

1. Defining Lines of Operation

This research could not identify the term *line of operation* used in any commercial business literature. It seems Supply Corps line of operation verbiage may be adapted from JP 5-0, *Joint Operational Planning*. JP 5-0 states that a line of operation “defines the interior or exterior orientation of the force in relation to the enemy or that connects actions on nodes and/or decisive points related in time and space to an objective(s)” (JCS, 2011, p. 105). Lines of operation connect various actions that are critical to meeting an operational objective, and can occur in sequence or parallel (JCS, 2011, p. 105). Figure 9 shows an example of a line of operation in the context of operational planning and not logistics. As mentioned earlier, the Supply Corps 2040 Strategic Vision Study explains lines of operation as the primary and complementary functional areas that represent base

skills of the Supply Corps. Additionally, the Supply Corps differentiates lines of operation according to their core capabilities (NAVSUP, 2010).

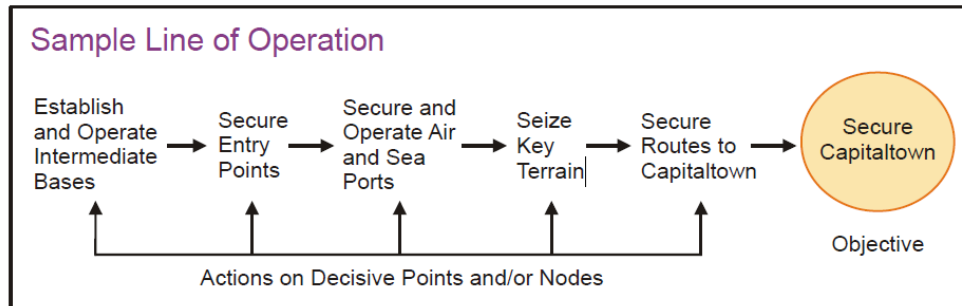

Figure 9. Line of Operation, Operational Context. Source: JCS (2011, p. 105).

Although business literature does not explicitly identify lines of operation, there are various terms that are often used in a similar fashion, many of which are confusingly used interchangeably. Core competencies, core capabilities, key functions, and resources were the prevalent terms found in this research. Because the Supply Corps makes a clear distinction between lines of operation and core competencies, this study only briefly examines core competencies of organizations, and instead focus on finding and understanding an equivalent term for lines of operation as functional areas, key capabilities, and base skills of an organization.

2. Core Competencies and Capabilities

The idea of core competence in a corporation is discussed in the heavily referenced article by Prahalad and Hamel (1990). Although mainly presented through the lens of outsourcing or identifying and developing core competencies to gain a competitive advantage against competition, the idea of core competencies is presented as an organization's critical resource as a result of the collective learning in the organization (Prahalad & Hamel, 1990). The authors distinguish core competencies from core products, with the latter being the "tangible link between identified core competencies and end products" while comprised of one or more core competencies (Prahalad & Hamel, 1990, p. 85). Additionally, Prahalad and Hamel offered three tests to identify core

competencies. First, it must provide access, or potential access, to a broad variety of markets. Next, it makes a “significant contribution to the perceived customer benefits of the end product” (Prahalad & Hamel, 1990, p. 83). Finally, they should be hard for competitors to imitate (Prahalad & Hamel, 1990, p. 84). Since the Supply Corps 2040 Strategic Vision Study differentiated between Supply Corps core competencies and lines of operation, perhaps the lines of operation are equivalent to Prahalad and Hamel’s description of core products. In that sense the lines of operation, or core products, of Acquisition, SCM, and OPLOG lead to a proliferation of end products as logistics support capabilities to the Fleet and Joint Warfighters.

Identifying core competencies of a military organization in order to identify capabilities for response to humanitarian assistance disasters was the research focus of Apte, Goncalves, and Yoho (2016). Drawing from Prahalad and Hamel’s (1990) three-part test to identify core competencies of a firm, the study offered three tests to identify core capabilities for an organization to provide humanitarian assistance and disaster response. First, the capability should be unique to the organization and not easily imitated by competitors. Next, it has the ability to provide humanitarian relief services in a wide variety of situations and contexts. Finally, a core competency should make a substantial contribution to the final customer or end-user (Apte, Goncalves, & Yoho, 2016, pp. 244-246).

The study found in a Humanitarian Operation environment with a mix of government and non-government players, the military offered competencies in movement, transportation, material management, rapidly deployable state-of-the-art trauma and general medical care, and strong intra-organizational communication systems (Apte et al., 2016, p. 253). Each organization knowing its own competencies and capabilities can help enable efficient joint operations. Further, examples of military core capabilities for Humanitarian Operations are inventory management, manage supplies and equipment, and move and sustain the force (Apte et al., p. 253). The research provided context and application of military specific core competencies and core capabilities in an operational environment, complementing Prahalad and Hamel’s (1990) view of core competencies in a traditional firm.

3. Wal-Mart and Amazon Logistics

Although typically labeled as retailers, both Wal-Mart and Amazon show the importance of strong logistics operations. With almost 12,000 retail units in 28 countries and e-commerce in 11 countries all producing \$485.9B in revenue for their FY17 (Wal-Mart , 2017a, p. 16). Wal-Mart has an expansive footprint to support. Its success is largely influenced by its logistics excellence with core functions seemingly in transportation and distribution, supply chain management, and purchasing. With over 150+ distribution centers in the United States that act as hubs in a hub-and-spoke logistics support system, they ship merchandise, groceries, and other goods to stores, clubs, and directly to customers. Additionally, Wal-Mart also has six disaster distribution centers in strategic locations in the United States ready for emergency response. These 150+ centers each support 90-100 stores in a 150+ radius via a private fleet of trucks and drivers (Wal-Mart , 2017b). Because there is an abundance of distribution centers with fast and efficient transport of goods to their retail stores, Wal-Mart is positioned to meet its customer's demands. Further bolstering their ability to respond to demand is Wal-Mart's use of information technology for near real-time visibility on point-of-sale (POS) that helps with inventory management and re-supply requirements. Finally, Wal-Mart uses its purchasing power to negotiate with suppliers for the lowest price on goods, which allows the company to not only sell to the customers at an advertised lowest price available, but also increases the profit margins on items (Khade & Lovaas, 2009).

Like Wal-Mart, Amazon.com or Amazon, has regional warehouses referred to as Fulfillment Centers, strategically positioned and uses an efficient deployment and distribution as a main function of logistics. Amazon has increased their fulfillment centers from eight in 2006 to 90 in 2016 located throughout the United States, with aims to increase to over 100 by 2018 (Houde, Newberry, & Seim, 2017). Although Wal-Mart does have an e-commerce presence as well as brick-and-mortar retail presence, Amazon does not necessarily have its own branded retail stores but enables third-party sellers and suppliers to utilize their logistics and growing delivery capabilities. Continually seeking innovation, Amazon incorporates robotics and automation into their supply chain warehouses, and using drones for parcel delivery (Schreiber, 2016). These innovations

aim to make processes more efficient and streamlined; however, they do not seem to fundamentally change what the core logistics functions are. Strong transportation and distribution, supply chain management, and purchasing competency are the primary logistics capabilities used by Wal-Mart and Amazon.

D. LITERATURE REVIEW CONCLUSIONS

The first part of the literature review examined strategic guidance to provide context of how the Supply Corps decided on the current lines of operation in order to set the stage for this research. An across the board look at joint and military services' primary logistics functions were examined and apparent that although there is no standard terminology or organization across the services, there are similarities and differences across the board. We reviewed common business terminology to frame the equivalent term for lines of operation. Finally, the logistics functions and practices of Wal-Mart and Amazon was studied for a commercial business perspective that indicates core logistics functions as transportation and distribution, supply chain management, and purchasing. The next chapter discusses the data collection used for this study to provide a clearer definition and understanding of the current state of lines of operations.

THIS PAGE INTENTIONALLY LEFT BLANK

III. DATA COLLECTION

This chapter describes the research approach and the methods used to collect data to analyze the Supply Corps lines of operations. When initially posed with the research question, *What is a line of operation*, it was quickly determined that *line of operation*, in the context of logistics, is a term unique to the Supply Corps. Although the Strategic Vision Study (NAVSUP, 2010) briefly defines lines of operation, we needed further background to gain fidelity of the term in order to provide a substantiated definition. Comparing the lines of operation in the Supply Corps with other service's logistics doctrine provided a better understanding of the concept. To address the research question, *What is the state of the current Supply Corps lines of operation* we performed a review of the current billet distribution with respective skill coding is performed. Finally, to answer *Are there opportunities for improvements in the lines of operation* we examined recent promotion board convening orders for what the Supply Corps values in skills and how those skills are actually distributed across the Fleet.

A. RESEARCH APPROACH

In this chapter, we gather the current list of Supply Corps billets with respective job skill coding, along with the most recent (two years) data for Supply Corps promotion board convening orders. Promotion board convening orders explicitly communicate community specific desired job skills to selection board members to be preferred for promotion. The data collected is both quantitative (number of billets for each capability) and qualitative (promotion board convening order) to determine the key capabilities of the Supply Corps—and their respective lines of operation—as currently distributed and identify opportunities for change.

B. METHOD

1. Comparison of Logistics Functions

An across-the-board comparison of the Supply Corps lines of operation to other

agencies was performed in Chapter II. This initial comparison provided perspective on what capabilities the Supply Corps uses to support the Fleet and Joint Warfighter, and how those capabilities are grouped and utilized compared to other organizations. Additionally, the review captured a breakdown of how each organization categorizes its core logistics functions and capabilities. Table 2 highlights fundamental differences or similarities in core logistics functions gathered from the data. Chapter IV, Data Analysis, further details the differences and similarities of core functions.

Table 2. Comparing Lines of Operation to Doctrine

	Supply Corps Primary Lines of Operation			Supply Corps Complementary Lines of Operation		
	Acquisition	Supply Chain Mgt	OPLOG	Ops Analysis	Comptroller & Financial Mgt	Business Financial Mgt
Joint Pub 4-0	Yellow	Green	Grey	Grey	Grey	Grey
NDP 4-0	Grey	Green	Grey	Grey	Grey	Grey
Marine Corps	Grey	Green	Grey	Grey	Grey	Grey
Army	Yellow	Green	Grey	Grey	Grey	Grey
Air Force	Grey	Green	Yellow	Grey	Grey	Grey
HCS	Grey	Green	Yellow	Grey	Grey	Grey
	- Similar Core Function		- Partially Similar Core Function		- No Similar Core Function	

2. Collection of Supply Corps Billet Distribution

Working with NAVSUP Office of Personnel (OP), a complete list of Supply Corps shore billets with respective sub-specialty and AQD coding was obtained (as of 21AUG17). This detailed list of billets and job codes is the quantitative data for this research. 2,245 Supply Corps (active duty 3100 and Limited Duty Officer 6510 designator) billets were captured in this study.

The first step was to sort the billets, using Microsoft Excel, to remove the operational and training billets from the shore billets. After removing 866 operational and training billets, 1,380 shore billets remained. We sorted the shore billets by sub-specialty code in order to count the number of billets associated with the three primary (Acquisition, SCM, and OPLOG) and complementary (Comptroller and Financial Management, OR, Business Management) lines of operation. This study follows the Strategic Vision Study (NAVSUP 2010) grouping of lines of operation with respective sub-specialty codes for: Supply Chain Management (1302, 1302/AL_, 1307), Acquisition Management (1306, 3110/AK_), Comptroller and Financial Management (3110),

Business Management (1301), and Operations Analysis (3211). With the recent change in the process of identifying OPLOG billets as 9L1/2 AQD, a subjective categorization of OPLOG billets was required in this study. We categorized billets with the AQDs of Joint Operational Planner (JP) and Joint Maritime Operational Planner (JOM) as OPLOG. We categorized billets with 3212 sub-specialty code as OR, unless they also had an OPLOG AQD assigned. The initial summary provides the current distribution of Supply Corps billets by line of operation for a general summary of how the Supply Corps skills are supporting the Fleet. Of note, a similar data sort was conducted in the 2010 Strategic Vision Study; therefore, a comparison of the billet distribution in 2017 and in 2010 is also performed.

The sub-specialty code breakdown for billets is analyzed across total billets and by rank structure. Billets are categorized by the following: rank O1-O3, O4, O5, O6 and above. This detailed breakdown provides insight on the primary skills utilized throughout a typical career progression, and what lines of operation are particularly valuable for senior leadership positions. This would imply that expertise in certain lines of operation might provide greater opportunities for higher-ranking billets than others.

3. Collection of Recent Supply Corps Promotion Board Convening Orders

To obtain qualitative data on the capabilities and skills preferred by the Supply Corps, this study utilized publicly available convening orders for the FY17 and FY18 promotion boards to the rank of O4, O5, and O6. For this project, the convening orders serve as the means to determine the importance of Supply Corps skills. The major limitation for this qualitative data is that not all lines of operation are listed as priority in the promotion board precepts, so some subjectivity is needed. The complementary line of operation, Business Management, is not listed verbatim as a preferred skill in any of the convening orders. Therefore, the priority of that skill is not given in the data and cannot be determined in this study without some subjectivity. Just as overlap can occur with sub-specialty codes and AQDs (with billets being tied to both a sub-specialty code and AQD), overlap occurs with the preferred skills for promotion.

For example, the FY-17 Selection Board Convening Order for promotion to O-4 instructed board members to give due consideration to demonstrated performance and expertise to the following skills (listed in order of precedence): Acquisition Corps, Financial Resource Management, Expeditionary Warfare and Confronting Irregular Challenges, Naval Special Warfare Experience, and Joint Experience (DON, 2017c). Acquisition Corps is a self-nominative process with specific criteria including 4 years in a designated acquisition billet or in combination of approved experience tours, obtaining Defense Acquisition Workforce Initiative Act (DAWIA) Level II, and 24 hours of college credit in business courses (Office of Supply Corps Personnel, 2011). Therefore, it is possible that not only can the Acquisition Management line of operation billets enable Acquisition Corps membership, but certain Supply Chain Management billets and experience can count towards Acquisition Corps membership as well. Also, the skills in the convening orders are not the main determinants for promotion selection. Rather, the convening orders state sustained superior performance and best and fully qualified for promotion are still delineated in the convening orders. The data in Tables 3–5 provide additional qualitative perspective on functional skills valued by the Supply Corps.

Table 3. Consolidated O-4 Promotion Board Preferred Skills. Adapted from DON (2016c), DON (2017c).

FY-17 LCDR	FY-18 LCDR
1. Acquisition Corps	1. Acquisition Corps
2. Financial Resource Mgt	2. Financial Resource Mgt
3. Expeditionary Warfare and Confronting Irregular Challenges	3. Naval Special Warfare Experience
4. Naval Special Warfare Experience	4. Expeditionary Warfare and Confronting Irregular Challenges
5. Joint Experience	

Table 4. Consolidated O-5 Promotion Board Preferred Skills. Adapted from DON (2016b), DON (2017b).

FY-17 CDR	FY-18 CDR
1. Acquisition Corps	1. Acquisition Corps
2. Joint Experience	2. Joint Experience
3. Financial Resource Mgt	3. Financial Resource Mgt
4. Expeditionary Warfare and Confronting Irregular Challenges	4. Operational Analysis
5. Naval Special Warfare Experience	5. Navy Operational Planner
6. Operational Analysis	6. Naval Special Warfare Experience
7. Navy Operational Planner	7. Expeditionary Warfare and Confronting Irregular Challenges

Table 5. Consolidated O-6 Promotion Board Preferred Skills. Adapted from DON (2016a), DON (2017a).

FY-17 CAPT	FY-18 CAPT
1. Acquisition Corps	1. Acquisition Corps
2. Joint Experience	2. Joint Experience
3. Financial Resource Mgt	3. Financial Resource Mgt
4. Expeditionary Warfare and Confronting Irregular Challenges	4. Operational Analysis
5. Naval Special Warfare Experience	5. Navy Operational Planner
6. Operational Analysis	6. Naval Special Warfare Experience
7. Navy Operational Planner	7. Expeditionary Warfare and Confronting Irregular Challenges

C. SUMMARY

This chapter discussed the methodology of the data collection process in an effort to answer the three research questions: *What is a line of operation*, *What is the state of the current Supply Corps lines of operation* and *Are there opportunities for improvements in the lines of operation*. We collected the doctrine and data to better define what a line of operation is. This project analyzed a data call of current Supply Corps billets for distribution of sub-specialty codes overall to determine the current state of Supply Corps lines of operation. Finally, the research used past promotion board convening orders for the ranks of O4-O6 to help identify opportunities for improvements in the lines of operation.

IV. DATA ANALYSIS

This chapter analyzes and interprets the data from Chapter III. Generally, the data captures and highlights the diverse skillsets that Supply Corps officers provide to the combatant commanders and warfighter. Not only do Supply Corps officers provide common core logistics functions, but bring Acquisition, Financial, and Operations Analysis skills not common collectively in any other service's logistics doctrine and officers. The end result is a logistics officer with a well-rounded perspective and experience to optimally support the warfighter. However, there is potential for an officer that is a *jack-of-all trades yet master of none*, and for insufficient experience and training opportunities in lines of operation that are more valued by the Supply Corps community.

A. COMPARISON OF LINES OF OPERATIONS

1. Supply Chain Management

SCM is the only line of operation explicitly identified as a core logistics function in all of the comparative research. The Supply Corps defines SCM as

A complex and dynamic management system comprised of activities including product development, sourcing, manufacturing, and logistics, as well as the information and financial systems needed to coordinate them...the goal of SCM is simple: *provide the war fighter with the material necessary to meet combat and peace time objectives in the most effective and efficient manner possible.* (Office of Supply Corps Personnel, 2011, p. 11)

The management of supplies and services, inventory, and global supplier network were functional capabilities of Supply according to JP 4-0, *Joint Logistics* (JCS, 2013). The capability of Supply, as stated in Navy Doctrinal Publication 4, aligns with the Joint logistics doctrine (DON, 2001). Similarly for the Marine Corps, Supply as a functional area of Logistics and its capabilities matches both Navy and Joint doctrine (USMC, 1997). Though the Army organizes Logistics as a function under Sustainment, it still categorizes Supply as a primary function of Logistics (DA, 2012). Air Force doctrine does not explicitly list SCM as one of its 26 Combat Support Functions. However, Supply Management is captured as part of the Combat Support Function of Logistics

Readiness (USAF, 2017). The last defense-related literature analyzed in this study, The DOD Logistics Human Capital Strategy, recognizes Supply Management as one of its four primary technical workforce categories. Again, the HCS intent outlines a foundation for the logistics workforce, human resource practices, and culture in the future that is comprised of logisticians able to succeed in a joint operating environment due to their interchangeability of common competencies (OSD, 2008). Finally, in the commercial sector, the data on both Wal-Mart and Amazon shows that Supply Chain Management is paramount for successful logistics and operations (Khade & Lovaas, 2009; Houde et al., 2017). Based on the data, Supply Chain Management as a core logistics function across military and commercial organizations aligns as a principal line of operation for the Supply Corps.

2. Acquisition Management

Acquisition Management, while not as explicitly or consistently identified as a primary function of logistics as SCM from the data, is still recognized for its importance in supporting operations. The Supply Corps views Acquisition as comprised of three functional disciplines: Contracting, Business and Financial Management, and Logistics (Supply Chain Management), with contracting “represented in every facet of support that Supply Corps provide” (Office of Supply Corps Personnel, 2011, p. 6). Overall, the research data categorizes Acquisition Management, or a sub-set of the acquisition process such as contracting or procurement, as either: a) part of the Supply function of Logistics, b) its own logistics function as Operational Contracting, or c) a standalone support function and skillset separate from Logistics and logistics officers. JP 4-0 generally considers Material Acquisition as an aspect of the overall military functions of Logistics (JCS, 2013). NDP 4 categorizes Procurement and Contracting as capabilities within the Supply function of Logistics and not a standalone function (DON, 2001). The MCDP 4 aligns with Navy doctrine and also categorizes Procurement and Contracting within the Supply functions of Logistics (USMC, 1997). The Army broadly captures Acquisition as an aspect in its definition of Logistics. However, it also lists Operational Contracting as its own distinct Logistics capability—and not a subset—along the same lines of Supply, Transportation, Distribution, and others (DA, 2012). This seems to underscore the value

of Contracting to Logistics by the Army. The Air Force, on the other hand, lists Acquisition as one of its 26 Combat Support Functions but as a separate function from Logistics (USAF, 2011). The Air Force Logistics Readiness Officer career training plan lists Supply as one of its core functions, which may consist of the Acquisition process if consistent with other services' view of Supply. However, there is no specific function for Acquisition Management, to include Contracting, under Logistics Readiness. In fact, the Contracting Officer career field in the Air Force is completely separate—including training and promotion - from the Logistics Officer career (USAF, 2017). This suggests that the Air Force truly values the skills and training related to Acquisition to designate its own career pipeline. The DOD Logistics Human Capital Strategy identifies Acquisition as a process, and lists it as part of the Life Cycle Logistics technical workforce category (OSD, 2008). In the commercial sector, Wal-Mart's purchasing power with its suppliers gave it a distinct advantage for its retail success (Khade & Lovaas, 2009). Whether captured as a capability of Supply or Life Cycle Logistics, as its own logistics function of Operational Contracting, or as its own core support function and career path, Acquisition and its components nevertheless is viewed as a critical skill and capability for the warfighter. As the primary logisticians for the Navy, Supply Corps officers benefit with this skill as a core function, and as a principal line of operation.

3. Operational Logistics

Perhaps the most ambiguous of all the Supply Corps lines of operation from the research is OPLOG. Even the definition of OPLOG, as a function and not just as an operating environment similar to Strategic and Tactical Level Logistics, is not consistent across the data. Further, most logistics doctrine does not specifically mention the term OPLOG at all. However, the importance of logistics planning to the success of operations was consistently mentioned throughout the data.

OPLOG, as defined by the Supply Corps 2040 Strategic Vision Study, “involves the planning, coordination and oversight of theater-wide logistics support to sustain and extend the reach of operational forces during a campaign or major operation” (NAVSUP, 2010, p. 85). Joint Logistics doctrine does not mention OPLOG verbatim, nor does the

Navy, Army, and Air Force's primary Logistics doctrine. MCWP 4-12, Operational Level Logistics, which expands on their Logistics Doctrine, identifies OPLOG but more as considerations to take while operating in the Operational Level of War and not as a function of logistics (USMC, 2016).

While the function of OPLOG is unclear in the research data, the importance of Logistics Planning is a common theme throughout all. The Air Force and DOD Human Capital Strategy explicitly listed planning as a capability for logistics (USAF, 2017; OSD, 2008). Joint doctrine includes planning in its very description of logistics, "includes planning and executing the movement and support of forces" (JCS, 2013, p. 19) and a role of the Joint Logistician to "plan, supervise, execute, synchronize, and coordinate core joint logistic functions" (JCS, 2013, p. 20). Similarly, planning is in the Army's definition of logistics, "the planning and executing of the movement and support of forces" and that sustainment planning is a must (DA, 2012, p. 1). The Navy recognizes logistics planning as force multiplier (DON, 2001) and Marine Corps deems planning as essential (USMC, 1997). Therefore, the data suggests that logistics planning is a key function for successful logistic operations. As the Supply Corps incorporates logistics planning into their function of OPLOG, it can be reasoned that OPLOG aligns as a Principal line of operation that is critical in supporting the warfighter.

4. Comptroller and Financial Management

The Supply Corps categorizes the functional skills of Comptroller and Financial Management as Complementary and not Principal Lines of Operation (NAVSUP, 2010). None of the research data lists these types of skills as a logistics function. However, this should not be interpreted that these functions are not beneficial or complement the core functions of logistics. The Supply Corps organizes three interrelated disciplines within the broad functional area of Financial Management: Comptroller, Financial Management, and Business and Financial Management (BFM). The Supply Corps states Comptrollers, "Maintain cognizance over all financial planning, programming, budgeting, accounting, allocation, control, and execution of resources and funds for DOD organizations" (Office of Supply Corps Personnel, 2011, p. 9) and that Financial Management functions

“comprise those activities which support Comptroller functions including budget formulation, funds management and funds execution in accordance with established policies and regulation governing operation” (Office of Supply Corps Personnel, 2011, p. 9). In terms of alignment with lines of operation, BFM is categorized under Acquisition Management (Office of Supply Corps Personnel, 2011).

Additionally, because these skills may not be performed by the logistics personnel from the various organizations researched, does not mean that Supply Corps officers do not perform these functions or have a need to perform these functions. In fact, the 2040 Strategic Vision Study recognizes that the Principal Lines of Operation serve Navy and non-Navy stakeholders whereas the Complementary Lines of Operation are skills desired by Supply Corps stakeholders (NAVSUP, 2010). The Billet Distribution analysis of this chapter will display that Supply Corps officers are placed in jobs that require these complementary-type skills. From a perspective of core logistics functions, the data supports that Comptroller and Financial Management are not core functions, but align more as complementary skills for a Logistics Officer.

5. Operations Research, Analysis, and Assessment

The Supply Corps defines Operations Analysis as “an interdisciplinary branch of applied mathematics and formal science helping management achieve its goals using scientific methods” (NAVSUP, 2010, p. 85). Likewise, Operations Research analysts apply problem-solving techniques to real world problems to develop decision support tools for their organizations to make better choices on decisions. (Office of Supply Corps Personnel, 2011) None of the logistics doctrine list Operations Analysis outright as a core function. However, the DOD Logistics Human Capital Strategy lists Supportability Analysis and Reliability and Maintainability Analysis as capabilities under its Life Cycle Logistics Workforce Technical Competency (OSD, 2008). The Supply Corps views Operations Analysis/Research more as a complementary skill than a career path or line of operation that Supply Corps officers can use across numerous positions to enhance performance in Supply or Logistics (Naval Supply Systems Command, 2010; Office of Supply Corps Personnel, 2011). Although both OPLOG and OR are skills that can be

used across all functions of logistics to enhance performance, the Supply Corps views one as a Principal line of operation and the other as Complementary. The comparative research does not show sufficient data to suggest OR is a core logistics function therefore it aligns with the Supply Corps view that OR is a Complementary line of operation.

6. Business Management

Just as Comptroller and Financial Management were not found in any of the research data as logistics functions, neither is the Supply Corps Complementary line of operation of Business Management. What is confusing is how the Supply Corps organizes and categorizes Business Management. The 2040 Strategic Vision Study (NAVSUP, 2010) lists Business Management as skills learned through the Supply Corps' civilian education Masters of Business Administration program (Supply Corps 810 Program or equivalent Top-25 Business School degree) and annotated with a sub-specialty job code of 1301 (Supply Acquisition, Distribution Management). Yet the Supply Corps' *It's Your Experience* playbook, a career path reference book for Supply Corps Officers, only mentions the 1301 sub-specialty code under the Supply Chain Management section, and does not even have a section on the Business Management line of operation (Office of Supply Corps Personnel, 2011). Given that the research does not support Business Management as a core logistics function, it supports the Supply Corps categorization of Business Management as a Complementary line of operation that is important for Supply Corps stakeholders with skills that will enhance the performance of various other functional areas, but not as a principal and core function of logistics.

7. Supply Corps Lines of Operation Summary

The research data of logistics doctrine reaffirms that SCM, Acquisition Management, and OPLOG are core functions of logistics and therefore suitably classified as Principal lines of operation. The Principal lines of operation either unanimously align with the core functional areas of logistics (such as SCM), are capabilities in a logistics functional area or deemed valuable enough to be designated its own function of support (such as Acquisition Management), or is interwoven in the entire logistics process and essential for optimal and efficient logistics support (such as OPLOG). The data also

supports the Supply Corps' classification of Comptroller and Financial Management, OR, and Business Management as Complementary Lines of Operation. These Complementary lines of operation are important for Supply Corps stakeholders and act to enhance the performance of logistics across a range of billets, however, are not core functions deemed essential to providing logistics support to the Navy and warfighter.

B. CURRENT STATE OF LINES OF OPERATION

There are 2,245 total Supply Corps billets as of the data collection. Currently, 620 (28%) of total billets are Operational/Sea billets and 1,625 (72%) of the total billets are shore. For comparison, the data from Strategic Vision Study (2010) found 2,321 Supply Corps billets with 698 (30%) Operational/Sea billets and 1,623 billets (70%) ashore. There are 78 less Operational/Sea billets compared to 2010 and two more shore billets. Overall, there is a net reduction of 76 total Supply Corps billets since 2010, mainly at the expense of Operational/Sea billets.

Of the 1,625 shore billets examined, only 49% (792) are tied to a sub-specialty code or AQD. The remaining 51% are not coded and are characterized as either Staff/General Supply (529) or Pipeline (304). Pipeline billets include students, transient patients, and prisoner holdees. Ideally, the majority, if not all, applicable shore billets are associated with a line of operation thus ensuring that Supply Corps officers are in positions to gain and develop those valuable skills. For comparison, the Strategic Vision Study (NAVSUP, 2010) reported 46% (751) of ashore billets tied to a sub-specialty code or AQD and 54% of shore billets as either Staff/General Supply (559) or Pipeline (313). The data shows that since 2010, although the number of total shore billets has only increased by two, there are 41 more shore billets associated and tied to a sub-specialty code or AQD. Though progress has been made in identifying and tying functional skills for billets, there is still a high amount (529) of billets that are not coded to any functional skill and therefore are not signaling the demand for officer placement, or potentially not providing and documenting the valued skills expected from Supply Corps officers.

Of note, the remaining 792 ashore billets associated with a sub-specialty code or AQD can further segregate 136 billets that are assigned a sub-specialty and/or AQD

which do not align to a line of operation. Examples include billets designated as Joint, submarine qualification, network operations and technology, requirements management, among others. Although these billets have valued skills, they are not tied to any Principal or Complementary line of operation in Supply Corps guidance. As this study focuses on lines of operation, no further analysis is conducted on those billets, but concerns are stated in the limitations and recommendations sections of this study.

1. Principal Lines of Operation

Sixty-eight% (539) of all coded billets align to one of the three Principal lines of operations. These billets represent the Supply Corps' primary functional areas that directly support the Navy and warfighter and align with the mission and strategic objectives.

The SCM line of operation includes Supply Chain Management (1302 sub-specialty code) billets, acquisition logistics billets (1302 sub-specialty code and AL_ Additional Qualification Designation), bulk petroleum management billets (1307 sub-specialty code), Supply Chain Management Logistics and Transportation Management billets (3121 sub-specialty code), Supply Chain Management Logistics Information Technology billets (1309 sub-specialty code), Transportation Logistics Management billets (1304 sub-specialty code) representing 28% (221) of coded ashore billets.

The Acquisition Management line of operation includes contracting (1306 sub-specialty code and AC_ Additional Qualification Designation) and Business Financial Management billets (3110, 3111 sub-specialty code and AK_ Additional Qualification Designation) with 34% (273) of the coded ashore billets.

The OPLOG line of operation includes operational logistics planner billets (JP_, JOM, JPM Additional Qualification Designation) and petroleum planning billets (1307 sub-specialty code) representing 6% (45) of the coded ashore billets.

2. Complementary Lines of Operation

Fifteen% (117) of all coded billets align to one of the three Complementary Line of Operations. These billets support the Principal Lines of Operation and enhance the core functions to achieve mission and strategic objectives.

Comptroller and Financial Management line of operation includes Financial Manager (3100, 3110, 3111 sub-specialty code), Comptroller (3112 sub-specialty code), Financial Management Energy (3113 sub-specialty code) billets representing 4% (31) of the coded ashore billets.

Business Management line of operation includes Supply Acquisition, Distribution Management (1301 sub-specialty code) billets representing 5% (43) of the coded ashore billets.

OR line of operation includes Operations Analysis (3211 sub-specialty code), Operations Research – Logistics Analysis (3212 sub-specialty code), Operations Research Analysis – Analysis and Assessment (3211 sub-specialty code) billets representing 5% (43) of the coded ashore billets.

3. Lines of Operation Billet Distribution by Rank

Rank of O-6 (160 total billets): twenty-five% (40) of the total billets are un-coded. Of coded billets (120), Acquisition Management represented 31% (37) of billets, Supply Chain Management represented 20% (24), Business Management represented 10% (12), Comptroller and Financial Management represented 7% (8), Operations Research represented 6% (7), and OPLOG represented 3% (4). There is 23% (28) of billets that are coded but not tied to a Principal or Complementary line of operation. The data suggests that almost half (48%) of O-6 billets are either un-coded or not aligned with a line of operation. The demand for Acquisition and SCM expertise continues throughout an officer's career progression. The demand for OPLOG expertise, at least serving in a coded billet, does not match the other lines of operation. Granted, valuable skills in OPLOG can develop during tours at the rank of O-5 and below.

Rank of O-5 (281 total billets): thirty-one% (86) of total billets are un-coded. Of coded billets (195), Acquisition Management represented 32% (63) of billets, Supply Chain Management represented 23% (44), Business Management represented 9% (18), Comptroller and Financial Management represented 4% (8), Operations Research represented 8% (16), and OPLOG represented 3% (6). Twenty-one% (40) of billets that are coded but not tied to a Principal or Complementary line of operation. Fifty-two% of all O-5 billets are either un-coded or do not align with a line of operation. Acquisition and SCM present as skills in demand at the O-5 level, and OPLOG with lowest demand for skill directly attached to a billet.

Rank of O-4: (388 total billets): twenty-eight% (108) of total billets are un-coded. Of coded billets (280), Acquisition Management represented 26% (72) of billets, Supply Chain Management represented 29% (81), Business Management represented 4% (10), Comptroller and Financial Management represented 4% (11), Operations Research represented 7% (20), and OPLOG represented 11% (31). There are 20% (55) of billets that are coded but not tied to a Principal or Complementary line of operation. Overall, 48% of O-4 billets are either un-coded or do not align with a line of operation. SCM represented the highest demand and opportunity for billets, and Comptroller and Financial Management with the lowest.

Rank of O-3 (330 total billets): fifty-six% (185) of total billets are un-coded. Of coded billets (145), Acquisition Management represented 45% (65) of billets, Supply Chain Management represented 28% (40), Business Management represented 2% (3), Comptroller and Financial Management represented 2% (3), Operations Research represented 14% (20), and OPLOG represented 3% (4). There are 7% (10) of billets that are coded but not tied to a Principal or Complementary line of operation. Sixty-three% of O-3 billets are either un-coded or do not align with a line of operation. More than half of the O-3 shore billets as presently coded do not provide opportunities for experience in a core logistics function.

Rank of O-2 (192 total billets): fifty-one% (97) of total billets are un-coded. Of coded billets (95), Acquisition Management represented 38% (36) of billets, Supply Chain Management represented 32% (30), Business Management represented 3% (3),

Comptroller and Financial Management represented 1% (1), Operations Research represented 21% (20), and OPLOG represented 4% (4). There is 1% (1) of billets that are coded but not tied to a Principal of Complementary Line of Operation. Acquisition Management and SCM are the main skills in demand or offering experience opportunity at the O-2 level.

Figure 10 summarizes the Line of Operation (LOO) distribution by ranks O2-O6.

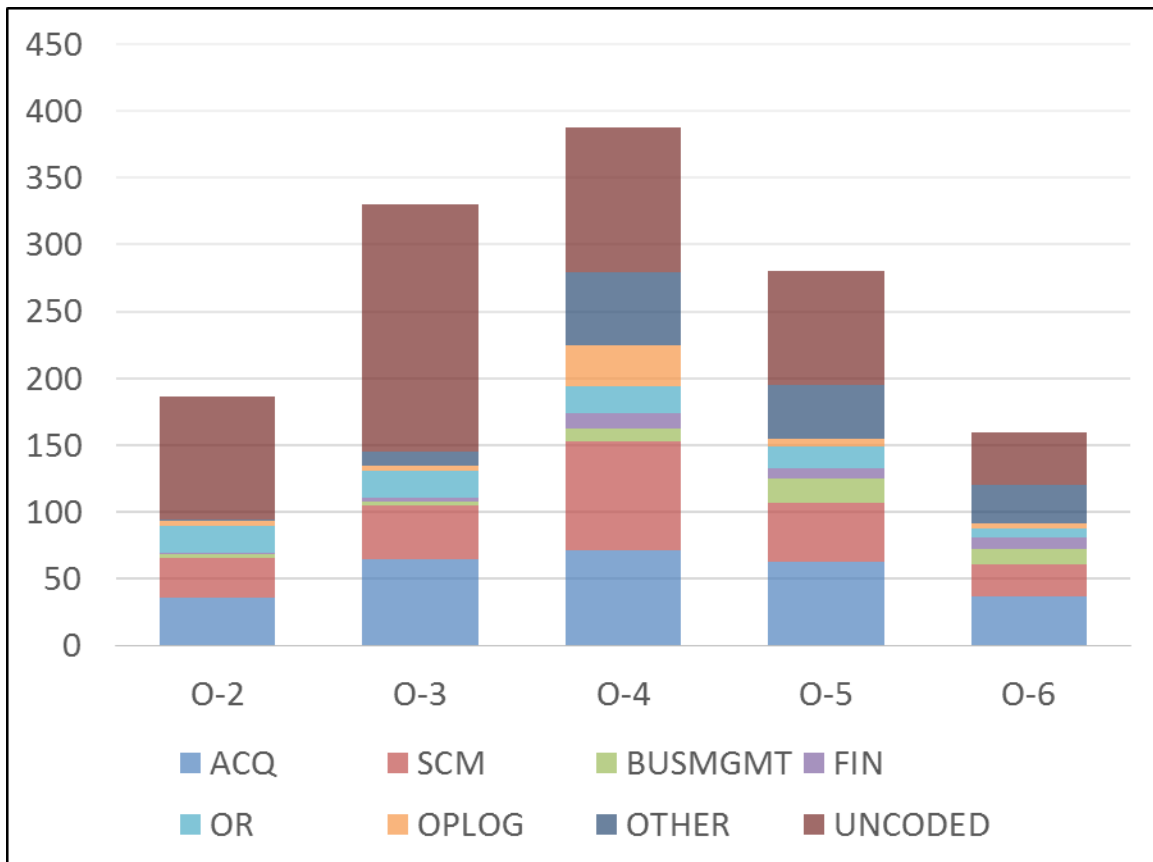

Figure 10. LOO Distribution by Rank—2017

C. COMPARISON OF BILLET DISTRIBUTION AND DESIRED FUNCTIONAL SKILLS

A review of the FY17 and FY18 Promotion Board Convening Orders to the Ranks of LCDR, CDR, and CAPT show that unanimously Acquisition Corps is a highly desired skill for promotion (Tables 3–5). This aligns with the designation of Acquisition Management and SCM as Primary Lines of Operation and with the distribution of those billets as the highest of all lines of operation. Also promulgated in the convening orders as highly desirable skills and experience are Navy Operational Planner, which is categorized in the OPLOG Line of Operation, and Operational Analysis, which is categorized in the OR line of operation. These skills are not identified in the LCDR Promotion Board Convening Order, but are mentioned in both the CDR and CAPT Promotion Board Convening Orders (Tables 3-5). The recent promotion board convening orders reinforce Acquisition Management, SCM, and OPLOG as Principal lines of operation, and shed light on the importance of OR as a Complementary Line of Operation.

The Complementary line of operation, Business Management, is not explicitly identified in any of the convening orders as one of the top desired skills. The skill/competency of Financial Resource Management is consistently listed in the top three desired skills for the LCDR, CDR, and CAPT promotion board convening orders (See Tables 3-5). However, the distribution of Financial Resource Management coded billets is only less than 7% for each of the ranks from O-3 through O-6. There are 14 fewer Financial Management billets than Business Management billets for ranks O-3 through O-6. Though there is potential for overlap of Financial Resource Management billets that can also classify into Acquisition Corps, it can also be noted that neither Contract Management nor Supply Chain Management are identified verbatim in the convening orders. This suggests that a consistently in-demand skill, Financial Resource Management, is not provided sufficient billet opportunity for officer experience and contribution to the Navy and joint warfighter.

The recent convening orders identified several valued skills and experience competences that are not directly tied to a specific line of operation but spread across

multiple lines of operation. The Supply Corps views these types of billets more as an operating environment than a career path, where Supply Corps officers can hone skills in both Primary and Complementary Lines of Operation (NAVSUP, 2010). Joint Experience, Naval Special Warfare Experience, and Expeditionary Warfare and Confronting Irregular Challenges were valued skills identified by the convening orders for all ranks (Tables 3-5). Considering the emphasis placed on these skills over the past two promotion cycles, and that there are more LCDR Joint Experience billets than Business Management and Comptroller and Financial Management billets combined, it would benefit to have future research on these skills and how they align as core functions of the Supply Corps and not just operating environments.

D. SUMMARY

This chapter compared the Supply Corps lines of operation individually to each of the other logistics doctrine researched to find similarities and differences that help frame what a line of operation is. The chapter also reviewed data of the current inventory of Supply Corps billets to study how the billets align to lines of operation by sub-specialty codes and how the core logistics functions distribute across billets in the Navy. Finally, the research evaluated recent promotion board guidance to compare how the preferred skills for promotion align with lines of operation. The final chapter provides the research limitations and answers the research questions for the study.

THIS PAGE INTENTIONALLY LEFT BLANK

V. CONCLUSION

A. LIMITATIONS

The concept of logistics is an art and science, intricate and complex. Further, each service has their own intricacies, theories on logistics, and specific support requirements based on their command organizational structure and deployment composition. This study is not a detailed comparison or analysis of each service's logistics and supply officer career progression or workforce structure, but a study on how other service's categorize and apply functions in support of logistics operations. Therefore, this research does not offer a definitive solution to what logistics is for the Navy based on interpretation of each other service's unique logistics concepts. Instead, this research takes a broad view on core competencies and functional capabilities across services to search for commonalities, differences, and opportunities for improvement when applied to the Supply Corps lines of operation.

Detailed analysis of future Supply Corps and Navy operating environments, objectives, or Strengths, Weaknesses, Opportunities, and Threats analysis is beyond the scope of this study. Additionally, any billet sub-specialty code changes after 21 Aug 2017 is not reflected in the data collection and analysis. Lastly, the sorting of billet sub-specialty codes as they are currently identified leaves room for interpretation. For example, billets with multiple sub-specialties and AQD codes were categorized into one line of operation in order to avoid double counting of billets. The precedence of classification used was: 1. Primary sub-specialty code, unless coded with JP3, JPM, JOM as primary AQD; 2. If no sub-specialty code then primary AQD; 3. If the AQDs AC_ , AK_ , or AL_ were attached to a billet, then consider as Acquisition Management or SCM depending on the respective sub-specialty code.

B. WHAT IS A LINE OF OPERATION?

Simply put, a line of operation is a core function of a Supply Corps Officer. Similar to the data collected from other doctrine, it is the core logistics functions and capabilities provided to the warfighter. The core logistics functions are the Principal lines

of operation of the Supply Corps and essential in providing logistics support. The Principal lines of operation are Acquisition Management, SCM, and OPLOG. The research finds that Supply Corps officers also provide capability enhancing skills and business acumen that are not common in the function of logistics by other services. These business skills are complementary to core logistics functions, but give Supply Corps officers a broad-based and distinct advantage in providing logistics support. The Complementary lines of operation are Business Management, Comptroller and Financial Management, OR. Adapting from JP 5-0 (JCS, 2011) definition of operational lines of operation, Supply Corps Principal and Complementary lines of operation connect various actions that are critical to meeting the operational objective of logistics support to the Navy and warfighter, and can occur in sequence or parallel. See Figure 10.

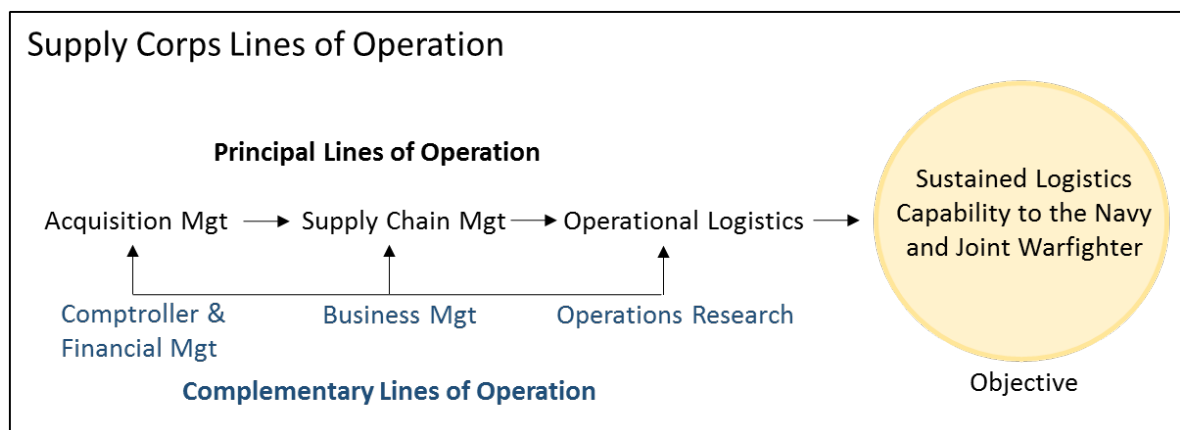

Figure 11. Supply Corps Lines of Operation. Adapted from JCS (2011), NAVSUP (2010).

C. WHAT IS THE STATE OF THE CURRENT SUPPLY CORPS LINES OF OPERATION?

The lines of operation are distributed appropriately across coded billets in relation to the categories of Principal (68%) and Complementary (15%) lines of operation. Of the coded billets, the associated lines of operation with the most dense billet distribution are the Principal lines of operation: Acquisition Management (273 billets), SCM (221 billets), and OPLOG (45 billets). However, there are 529 billets that are not assigned a

sub-specialty code or AQD, and 136 billets that are assigned a sub-specialty code and/or AQD but are not tied to either a Principal or a Complementary line of operation. See Figure 11 for the current state of overall LOO distribution.

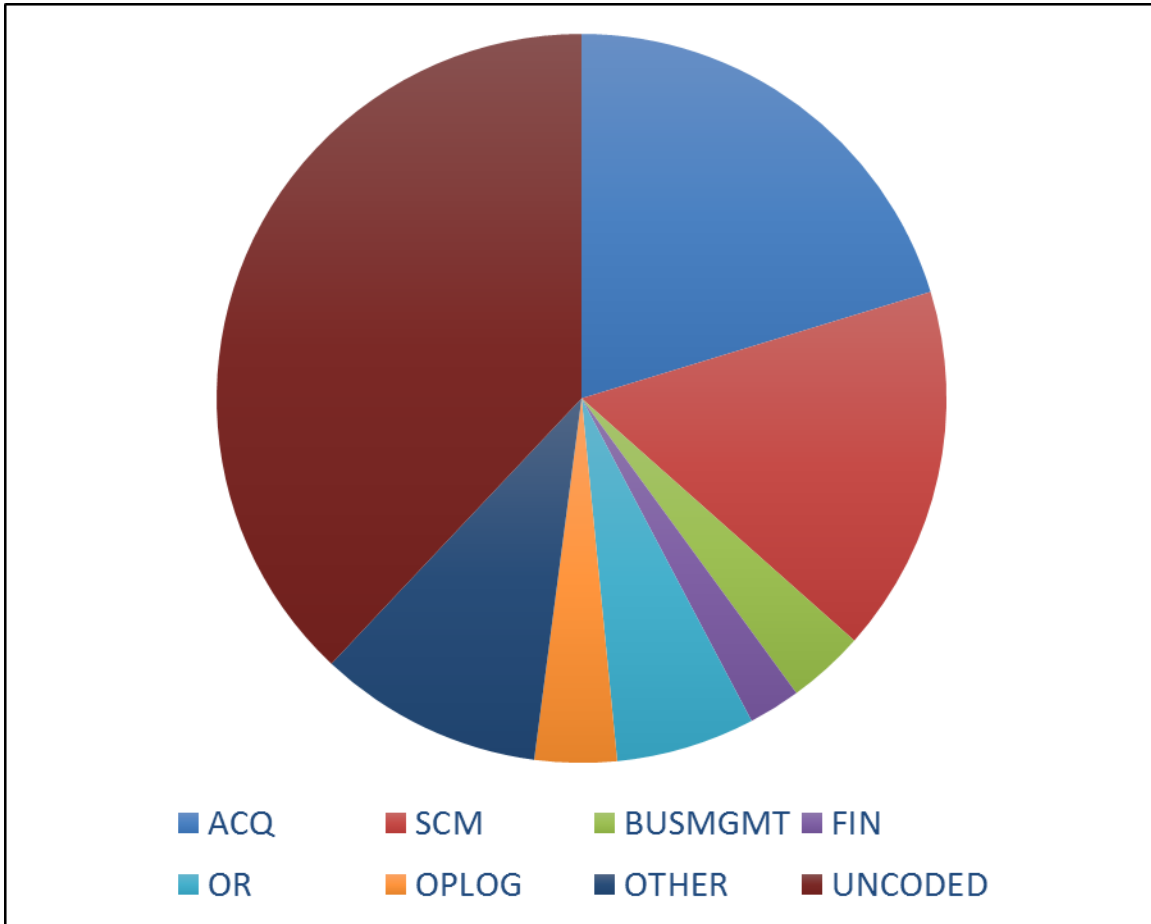

Figure 12. LOO Distribution by Coded Billet—2017

D. ARE THERE OPPORTUNITIES FOR IMPROVEMENTS IN THE LINES OF OPERATION?

The research data on Supply Corps lines of operation is generally limited to the 2040 Strategic Vision Study and various career playbook tools for Supply Corps Officers. This study adds additional research, references to the subject, and recognizes there are opportunities for improvement regarding lines of operation.

1. Realign Un-coded Shore Billets to Lines of Operation or Consider Divesting

Seven years has passed since the Supply Corps 2040 Strategic Vision Study and great strides have been made re-aligning billets and assigning sub-specialty codes to previously un-coded billets. However, there are still 529 shore billets—not including pipeline billets—that remain un-coded and not aligned with any line of operation. More significant, 74% (390) of the un-coded billets are for the ranks of O-2 through O-4. Placing the demand for skills in these junior officer billets and associating with a line of operation is important for career development and for promotion opportunity. If the un-coded billets do not align with a Principal or Complementary line of operation, then the Supply Corps should re-evaluate those billets' benefit to the mission and strategic objectives.

In addition to the un-coded shore billets, evaluate the 136 billets coded with skill identifiers that do not align with a line of operation. Perhaps there is opportunity to match the billets with a Principal or Complementary line of operation. If there is not, the type of work performed should be reviewed for its impact on the fleet and development of Supply Corps officers to be better logisticians. Granted, many of these billets are Joint, Naval Special Warfare, and Submarine coded, but there still may be opportunity to associate with a line of operation.

2. Further Research on Operational Logistics

This study supports the designation of OPLOG as a Principal line of operation. However, the Supply Corps coding of OPLOG billets is not easily navigable and decipherable. The 3212 sub-specialty code is still tied to several planning billets based on their billet descriptions, yet those same planning billets are not identified with any planning AQDs. It is hard to determine whether those billets are OPLOG, or truly OR. The recent establishment of the Operational Logistics Officer (OPLOGOFF1/2) AQD is a step forward, but is a self-nominated designation with insufficient data on the distribution of OPLOGOFF1/2 billets. The Supply Corps will benefit from detailed analysis on determining a more accurate data capture of clearly identified OPLOG billets, which will

provide a more accurate depiction of its billet distribution and associated impact across the fleet.

3. Synchronized and Consistent Messaging of Lines of Operation

The research highlights the wealth of career progression resources available to Supply Corps officers from *It's Your Career Experience* playbook and Community Briefs, to the Strategic Vision Study and access to promotion board convening orders. As ambiguous as terms such as logistics, competencies, and core functions are, adding a Supply Corps unique term such as line of operation only adds to the potential confusion for the Supply Corps officers and stakeholders. It is important to provide consistent messaging across all platforms on how the Supply Corps functions are aligned and executed. Updating the community briefs and career playbooks to separate OR from OPLOG will help streamline the message of lines of operation. Restructuring the *It's Your Experience* Playbook from a Community of Interest organized layout to a line of operation layout may help drive the message. Finally, the data on promotion board convening orders suggest that some lines of operation's skills – and even skills not aligned with a line of operation – are more valued for promotion than others. This can send mixed signals for Supply Corps officer career progression when considering billet opportunities.

4. Re-evaluate Financial Management, Joint, Special Warfare, and Expeditionary Skills

Can a complementary line of operation transition to a principal line of operation and vice versa, and what is the criteria? FM has the least billets of all lines of operation, but recent promotion board convening orders illustrate that FM is a valued skill for Supply Officers to learn and apply. Consideration should be given to how the Supply Corps can increase the distribution of FM billets to meet stakeholder demand and provide ample opportunities for Supply Officers to obtain and hone their experience. Joint, Naval Special Warfare, and Expeditionary Warfare are all valued by recent promotion boards, in some cases valued higher than OPLOG and OR, but are not currently labeled as lines of operation. Further study should seek to determine if there are unique skills performed

in these environments, which may lead to the identifying of potentially new lines of operation.

E. SUMMARY AND RECOMMENDATIONS

This MBA project incorporated data from various logistics doctrine to better understand the Supply Corps lines of operation. The data reaffirms current Supply Corps organization of Principal lines of operation (Acquisition Management, Supply Chain Management, Operational Logistics) as the core logistic functions used to deliver logistics capabilities to the Navy and joint warfighter, and Complementary lines of operation (Business Management, Comptroller and Financial Management, OR) that enhance the functions of Principal lines of operation through their unique business skills. The lines of operation functions are appropriately distributed across billets for delivery of capabilities and as opportunity for experience.

There are opportunities for improvement and we offer the following recommendations:

- Realign un-coded shore billets to lines of operation or consider divesting
- Further research on operational logistics
- Ensure synchronized and consistent messaging of lines of operation
- Re-evaluate FM, Joint, Special Warfare, and expeditionary skills

Many billets are still un-coded to a line of operation or any specific skill, and therefore not signaling demand for a type of experience or providing officers with documented experience as their career progresses towards promotion. The Supply Corps will benefit from continued annual billet reviews in order to re-align or divest billets. The Navy and Joint warfighter will benefit from the diverse and broad range of skills that Supply Corps officers provide, and whose combination of essential logistics functions and business acumen give a distinct competitive advantage to the Supply Corps community.

LIST OF REFERENCES

- Apte, A., Goncalves, P., Yoho, K. (2016). Capabilities and competencies in humanitarian operations. *Journal of Humanitarian Logistics and Supply Chain Management*, 6(2), 240–258. Retrieved from <https://doi.org/10.1108/JHLSCM-04-2015-0020>
- Department of the Army. (2012). *Sustainment* (ADP 4-0). Retrieved from http://www.apd.army.mil/epubs/DR_pubs/DR_a/pdf/web/adp4_0.pdf
- Department of the Navy. (2001, February 20). *Naval logistics* (NDP 4). Washington, DC: Military.
- Department of the Navy. (2016a, January 27). *Active duty officer boards, staff, O-6, FY17*. Retrieved from Navy Personnel Command: <http://www.public.navy.mil/bupers-npc/boards/activedutyofficer/06staff/Documents/FY-17/FY-17%20AO6S%20CONVENING%20ORDER.pdf>
- Department of the Navy. (2016b, March 15). *Active duty officer boards, staff, O-5, FY17*. Retrieved from Navy Personnel Command: <http://www.public.navy.mil/bupers-npc/boards/activedutyofficer/05staff/Documents/FY-17/FY-17%20AO5S%20CONVENING%20ORDER.pdf>
- Department of the Navy. (2016c, May 2). *Active duty officer boards, staff, O-4, FY17*. Retrieved from Navy Personnel Command: <http://www.public.navy.mil/bupers-npc/boards/activedutyofficer/04staff/Documents/FY-17/AO4S%20CONVENING%20ORDER.pdf>
- Department of the Navy. (2017a, January 27). *Active duty officer boards, staff, O-6, FY18*. Retrieved from Navy Personnel Command: <http://www.public.navy.mil/bupers-npc/boards/activedutyofficer/06staff/Documents/FY-18%20AO6S%20Convening%20Order.pdf>
- Department of the Navy. (2017b, March 20). *Active duty officer boards, staff, O-5, FY18*. Retrieved from Navy Personnel Command: <http://www.public.navy.mil/bupers-npc/boards/activedutyofficer/05staff/Documents/FY-18%20AO5S%20CONVENING%20ORDER.pdf>
- Department of the Navy. (2017c, May 11). *Active duty officer boards, staff, O-4, FY18*. Retrieved from Navy Personnel Command: <http://www.public.navy.mil/bupers-npc/boards/activedutyofficer/04staff/Documents/FY-18%20AO4S%20CONVENING%20ORDER.pdf>

- Houde, J. F., Newberry, P., & Seim, K. (2017, April). Economies of density in E-commerce: A study of Amazon's fulfillment center network (NBER Working Paper No. 23361). Retrieved from the National Bureau of Economic Research: <http://www.nber.org/papers/w23361>
- Joint Chiefs of Staff (2011). *Joint operational planning* (JP 5-0). Retrieved from http://www.dtic.mil/doctrine/new_pubs/jp5_0_20171606.pdf
- Joint Chiefs of Staff. (2013). *Joint logistics* (JP 4-0). Retrieved from http://www.dtic.mil/doctrine/new_pubs/jp4_0.pdf
- Khade, A. S., & Lovaas, N. (2009). Improving supply chain performance: A case of Wal-Mart's logistics. *International Journal of Business Strategy*, 9(1). Retrieved from <http://www.freepatentsonline.com/article/International-Journal-Business-Strategy/208534987.html>
- Naval Supply Systems Command. (n.d.). Strategic plan 2017–2021 and commander's guidance. Retrieved from Naval Supply Systems Command: <https://www.navsup.navy.mil/site/public/documents/enterprise/commandersguidance2017.pdf>
- Naval Supply Systems Command. (2010, March 31). *The Supply Corps 2040 strategic vision study*. Retrieved from Naval Supply Systems Command: https://www.navsup.navy.mil/site/public/documents/supply-corps/2040_study.pdf
- Navy Personnel Command. (n.d.). *Supply Corps Career Counselor FY18 active SC community brief*. Retrieved December 6, 2017, from <http://www.public.navy.mil/bupers-npc/officer/Detailing/rlstaffcorps/supply/Pages/CareerCounselor.aspx>
- Navy Personnel Command. (2017, October). *Manual of Navy officer manpower and personnel classifications volume I*. Retrieved from <http://www.public.navy.mil/bupers-npc/reference/noc/NOOCSVOL1/Documents/Entire%20NAVPERs%2015839I%20Vol%20I%20Oct%202017.pdf>
- Office of Supply Corps Personnel. (2011, Nov 1). Navy Supply Corps: It's your experience. Retrieved from <http://www.public.navy.mil/bupers-npc/officer/Detailing/rlstaffcorps/supply/Documents/IT%27S%20YOUR%20EXPERIENCE%201%20Nov%2011%20Logo%20free.pdf>
- Office of the Secretary of Defense. (2008). *DOD logistics human capital strategy*. Retrieved from http://cjsl.ndu.edu/Portals/94/Documents/DoD_Logistics_Human_Capital_Strategy.pdf?ver=2017-05-04-230323-107
- Prahalad, C.K. & Hamel, G. (1990). The core competence of the corporation. *Harvard Business Review*, 68(3), 79-91.

- Schreiber, Z. (2016, Jan 29). Is logistics about to get Amazon'ed? Retrieved from <https://techcrunch.com/2016/01/29/is-logistics-about-to-get-amazoned/>
- U.S. Air Force. (2011). *Combat support (AFDD 4-0)*. Washington, DC: Author.
- U.S. Air Force. (2017). *Career Field Education Training Plan (CFETP) Logistics Readiness Officer, AFSC 21RX*. Retrieved from http://static.e-publishing.af.mil/production/1/af_a4/publication/cfftp21rx/cfftp21rx.pdf
- U.S. Marine Corps. (1997). *Logistics (MCDP 4)*. Retrieved from <https://www.usmcu.edu/sites/default/files/epme/courses/MCDP%204%20Logistics.pdf>
- U.S. Marine Corps. (2016, June 2). *Operational logistics (MCWP 4-12)*. Washington, DC: Department of the Navy.
- Wal-Mart. (2017a, March 31). *Financial information, FY17 annual report*. Retrieved from [http://s2.q4cdn.com/056532643/files/doc_financials/2017/Annual/WMT_2017_AR-\(1\).pdf](http://s2.q4cdn.com/056532643/files/doc_financials/2017/Annual/WMT_2017_AR-(1).pdf)
- Wal-Mart. (2017b, Dec 5). Wal-Mart, our business. Retrieved from <https://corporate.walmart.com/our-story/our-business>

THIS PAGE INTENTIONALLY LEFT BLANK

INITIAL DISTRIBUTION LIST

1. Defense Technical Information Center
Ft. Belvoir, Virginia
2. Dudley Knox Library
Naval Postgraduate School
Monterey, California