



Calhoun: The NPS Institutional Archive
DSpace Repository

Theses and Dissertations

1. Thesis and Dissertation Collection, all items

2022-06

DOWNSTREAM BENEFITS OF RETROFITTING AGED DOD BUILDING STOCK WITH A FOCUS ON INCREASING BUILDING ENVELOPE EFFICIENCY

Reed, Shawn D.

Monterey, CA; Naval Postgraduate School

<https://hdl.handle.net/10945/70727>

This publication is a work of the U.S. Government as defined in Title 17, United States Code, Section 101. Copyright protection is not available for this work in the United States.

Downloaded from NPS Archive: Calhoun



Calhoun is the Naval Postgraduate School's public access digital repository for research materials and institutional publications created by the NPS community. Calhoun is named for Professor of Mathematics Guy K. Calhoun, NPS's first appointed -- and published -- scholarly author.

Dudley Knox Library / Naval Postgraduate School
411 Dyer Road / 1 University Circle
Monterey, California USA 93943

<http://www.nps.edu/library>



**NAVAL
POSTGRADUATE
SCHOOL**

MONTEREY, CALIFORNIA

MBA PROFESSIONAL PROJECT

**DOWNSTREAM BENEFITS OF RETROFITTING
AGED DOD BUILDING STOCK WITH A FOCUS ON
INCREASING BUILDING ENVELOPE EFFICIENCY**

June 2022

By: Shawn D. Reed

Advisor: Kristen Fletcher
Co-Advisor: Amilcar A. Menichini

Approved for public release. Distribution is unlimited.

THIS PAGE INTENTIONALLY LEFT BLANK

REPORT DOCUMENTATION PAGE			<i>Form Approved OMB No. 0704-0188</i>
Public reporting burden for this collection of information is estimated to average 1 hour per response, including the time for reviewing instruction, searching existing data sources, gathering and maintaining the data needed, and completing and reviewing the collection of information. Send comments regarding this burden estimate or any other aspect of this collection of information, including suggestions for reducing this burden, to Washington headquarters Services, Directorate for Information Operations and Reports, 1215 Jefferson Davis Highway, Suite 1204, Arlington, VA 22202-4302, and to the Office of Management and Budget, Paperwork Reduction Project (0704-0188) Washington, DC 20503.			
1. AGENCY USE ONLY (Leave blank)	2. REPORT DATE June 2022	3. REPORT TYPE AND DATES COVERED MBA Professional Project	
4. TITLE AND SUBTITLE DOWNSTREAM BENEFITS OF RETROFITTING AGED DOD BUILDING STOCK WITH A FOCUS ON INCREASING BUILDING ENVELOPE EFFICIENCY		5. FUNDING NUMBERS	
6. AUTHOR(S) Shawn D. Reed			
7. PERFORMING ORGANIZATION NAME(S) AND ADDRESS(ES) Naval Postgraduate School Monterey, CA 93943-5000		8. PERFORMING ORGANIZATION REPORT NUMBER	
9. SPONSORING / MONITORING AGENCY NAME(S) AND ADDRESS(ES) N/A		10. SPONSORING / MONITORING AGENCY REPORT NUMBER	
11. SUPPLEMENTARY NOTES The views expressed in this thesis are those of the author and do not reflect the official policy or position of the Department of Defense or the U.S. Government.			
12a. DISTRIBUTION / AVAILABILITY STATEMENT Approved for public release. Distribution is unlimited.		12b. DISTRIBUTION CODE A	
13. ABSTRACT (maximum 200 words) This report examines the downstream benefits of retrofitting current building stock on Department of Defense (DOD) installations. A holistic approach is necessary to achieve the objectives laid out by the executive branch to achieve a net-zero emissions building portfolio by 2045. Current procurement standards address this objective with new construction; however, most buildings within the DOD stock were built ahead of these initiatives and 29% have exceeded their life expectancies. Since this represents a large portion of the DOD building stock, priority should be given to building envelope retrofit projects to reduce the thermal demand in a logically sequenced approach toward net-zero goals. These initial steps are necessary to improve efficiencies that will lead to reduced demand and facilitate downstream investments in alternative and reduced-emissions systems. This report utilized a case study done at NPS that highlights the savings achieved from buildings with tight envelopes and investigated funding streams to achieve these goals.			
14. SUBJECT TERMS energy efficiency, net-zero emissions, energy resilience, policy, building envelope		15. NUMBER OF PAGES 79	
		16. PRICE CODE	
17. SECURITY CLASSIFICATION OF REPORT Unclassified	18. SECURITY CLASSIFICATION OF THIS PAGE Unclassified	19. SECURITY CLASSIFICATION OF ABSTRACT Unclassified	20. LIMITATION OF ABSTRACT UU

THIS PAGE INTENTIONALLY LEFT BLANK

Approved for public release. Distribution is unlimited.

**DOWNSTREAM BENEFITS OF RETROFITTING AGED DOD BUILDING
STOCK WITH A FOCUS ON INCREASING BUILDING
ENVELOPE EFFICIENCY**

Shawn D. Reed, Lieutenant, United States Navy

Submitted in partial fulfillment of the
requirements for the degree of

MASTER OF BUSINESS ADMINISTRATION

from the

**NAVAL POSTGRADUATE SCHOOL
June 2022**

Approved by: Kristen Fletcher
Advisor

Amilcar A. Menichini
Co-Advisor

Amilcar A. Menichini
Academic Associate, Department of Defense Management

THIS PAGE INTENTIONALLY LEFT BLANK

DOWNSTREAM BENEFITS OF RETROFITTING AGED DOD BUILDING STOCK WITH A FOCUS ON INCREASING BUILDING ENVELOPE EFFICIENCY

ABSTRACT

This report examines the downstream benefits of retrofitting current building stock on Department of Defense (DOD) installations. A holistic approach is necessary to achieve the objectives laid out by the executive branch to achieve a net-zero emissions building portfolio by 2045. Current procurement standards address this objective with new construction; however, most buildings within the DOD stock were built ahead of these initiatives and 29% have exceeded their life expectancies. Since this represents a large portion of the DOD building stock, priority should be given to building envelope retrofit projects to reduce the thermal demand in a logically sequenced approach toward net-zero goals. These initial steps are necessary to improve efficiencies that will lead to reduced demand and facilitate downstream investments in alternative and reduced-emissions systems. This report utilized a case study done at NPS that highlights the savings achieved from buildings with tight envelopes and investigated funding streams to achieve these goals.

THIS PAGE INTENTIONALLY LEFT BLANK

TABLE OF CONTENTS

I.	INTRODUCTION.....	1
A.	PURPOSE AND IMPORTANCE	1
B.	BUILDING ENVELOPES	3
C.	STUDY ORGANIZATION.....	4
II.	LITERARY REVIEW	7
A.	THE DOD ENVIRONMENT FOR ENERGY AND INFRASTRUCTURE	7
B.	FUNDING ANALYSIS.....	12
1.	Budget Model	12
2.	Appropriations	13
3.	Alternate Funding Streams.....	17
C.	BUILDING ENVELOPE EFFECTIVENESS	19
D.	RETROFIT STRATEGIES	21
1.	Windows/Glazing	22
2.	Window Films.....	24
3.	Solar Shading	25
4.	Solar-Reflective Paint	26
5.	Insulation	27
6.	Cladding.....	27
7.	Air Tightness	27
E.	EMERGING TECHNOLOGIES	28
1.	Thermally Anisotropic Composites.....	28
2.	Insulation-inflatable Walls.....	29
3.	PV Envelope	29
4.	Phase Changing Material.....	30
5.	Green/Living Walls.....	31
F.	METHODS FOR PROBLEM IDENTIFICATION	32
III.	METHODOLOGY	33
A.	MULTIPLE CASE STUDY ANALYSIS.....	33
B.	DESIGN OF CASE STUDIES.....	33
IV.	CASE STUDY RESULTS	37
A.	OVERVIEW	37
B.	NPS CASE STUDY.....	37
1.	Building 1: Dudley Knox Library (BLDG 339)	38

2.	Building 2: ME Lecture Hall (BLDG 255)	39
3.	Building 3: Reed Hall (BLDG 310)	41
C.	CASE STUDIES IN LITERATURE	42
1.	NPS Windows and Doors Project	42
2.	Office Building Retrofit in Spain	43
3.	Classroom Case Study in Egypt	44
4.	GSA Deep Retrofit Program	45
V.	ANALYSIS AND DISCUSSION	47
A.	PROBLEM STATEMENT	47
B.	ANALYSIS OF NPS CASE STUDY	47
C.	MULTIPLE CASE STUDY ANALYSIS	50
D.	RECOMMENDATION	51
VI.	CONCLUSION	53
A.	DOWNSTREAM BENEFITS OF BUILDING ENVELOPES	53
B.	THE HOLISTIC APPROACH	54
C.	OPPORTUNITIES FOR FURTHER RESEARCH	55
	LIST OF REFERENCES	57
	INITIAL DISTRIBUTION LIST	63

LIST OF FIGURES

Figure 1.	DOD Facility Sustainment Funding. Source: GAO (2022).....	15
Figure 2.	ESPC Cash Flows. Source: Tetreault and Regenthal (2011).....	18
Figure 3.	UESC Cash Flows. Source: Niro (2017).	18
Figure 4.	Energy Efficiency of Commercial Buildings Gained with Best Available Components. Source: Department of Energy (2015).	22
Figure 5.	Cross Section of Window Glazing. Source: Mohelníková and Altan (2009).....	23
Figure 6.	Function of Low-e Glazing. Source: Mohelníková and Altan (2009).....	25
Figure 7.	Solar reflective roof paint. Source: Casini (2016).	26
Figure 8.	Novel TAC envelope design. Source: Department of Energy (2019).	29
Figure 9.	PV Envelope. Source: Casini (2016).	30
Figure 10.	Green/living wall system. Source: Casini (2016).	31
Figure 11.	Energy consumption before and after retrofit. Source: Torgal et al. (2017).....	44
Figure 12.	Retrofit results. Source: El-Darwish and Gomaa (2017).....	45
Figure 13.	NPS case study combined results	48

THIS PAGE INTENTIONALLY LEFT BLANK

LIST OF TABLES

Table 1.	Various Glass U-Values. Adapted from Aguilar-Santana et al. (2020).....	24
Table 2.	Building 1: Dudley Knox Library (BLDG 339)	39
Table 3.	Building 2: ME Auditorium (BLDG 255)	40
Table 4.	Building 3: Reed Hall (BLDG 310).....	42
Table 5.	GSA Deep Energy Retrofit. Adapted from Shonder (2014).....	46

THIS PAGE INTENTIONALLY LEFT BLANK

LIST OF ACRONYMS AND ABBREVIATIONS

ARPA-E	Advanced Research Projects Agency-Energy
DOD	Department of Defense
ECM	Energy Conservation Measures
EO	Executive Order
ESCO	Energy Service Company
ESPC	Energy Conservation Performance Contract
FSM	Facilities Sustainment Model
FSRM	Facilities sustainment, restoration, and modernization
GAO	Government Accountability Office
GSA	General Services Administration
HVAC	heating, ventilation, and air-conditioning
IEA	International Energy Agency
INSG	Interim National Security Guidance
LiDAR	light detection and ranging
Low-E	low- emissivity glass
NECPA	National Energy Conservation Policy
NPS	Naval Postgraduate School
NAVFAC	Naval Facilities Engineering Systems Command
O&M	operations and maintenance
ROI	return on investment
SECDEF	Secretary of Defense
SECNAV	Secretary of the Navy
SMS	Sustainment Management System
UAV	Unmanned Aerial Vehicle
UESC	Utility Energy Service Contract
UFC	Unified Facilities Criteria
USD	Under Secretary of Defense
USMC	United States Marine Corps

THIS PAGE INTENTIONALLY LEFT BLANK

I. INTRODUCTION

A. PURPOSE AND IMPORTANCE

The United States is the second largest consumer of energy in the world and uses more than the next two countries combined (International—U.S. Energy Information Administration [EIA], n.d.). The current environment within the federal government has incited change from a top-down approach to new construction and energy awareness but neglects some areas to which this paper will discuss. A holistic approach is necessary to achieve federal objectives to achieve a net-zero emissions building portfolio by 2045. Focusing efforts on Department of Defense (DOD) installations will produce not only cost savings from reduced energy demand, but other significant downstream benefits found with retrofitting the current building stock. Within the country's energy use portfolio, the federal government is the largest consumer across all industries and the DOD makes up 77% of the government's energy use (EIA, n.d.). As the top consumer in the United States this translates to an opportunity and responsibility to lead the nation by example toward improving energy efficiency. The DOD's energy use is split into installation energy and operational energy, the former makes up 30% of their portfolio and the latter consumes the remaining 70% (Greenley, 2019). The DOD has chronically underfunded facilities sustainment which is leading to deteriorating facilities within its aged building stock.

The purpose of this study is to identify potential solutions to reduce the energy consumption of installation energy across the DOD. The focus will be on dissecting the current policy, actions, and funding within the government in this regard. This paper suggests future policy and retrofitting efforts within the aged building stock on DOD installations with a focus on building envelopes to reduce the unnecessary waste of energy and assist in meeting energy efficiency goals. It will discuss downstream benefits from large scale retrofit projects which include second and third order effects beyond improved building performance and reduced utility costs.

Following and supporting these retrofitting actions, the target buildings will then have the ideal pre-conditions to facilitate follow-on energy conservation improvements.

These can range from downsized heating, ventilation, and air-conditioning (HVAC) systems to the addition of energy systems with less emissions. These systems can include inputs from alternate energy sources which will foster the establishment of microgrids on base installations to enhance base resilience. A holistic approach will increase efficiencies and reduce pay-back periods for long term transitional projects as well as extend the life expectancy for older buildings. Reduced energy demand will also protect the DOD from the volatile energy market, which the original legislation for energy awareness and reduced consumption was based on.

Analysis will display the benefits of various studies proving that the retrofitting actions that include building envelope improvements save both energy consumption and operating costs over time. Investing in the assessment of the current building envelope conditions on base installations for a long term retrofit/repair plan should be the first step to a holistic approach in reduction of energy consumption by the DOD. This research will display the potential cost savings for retrofitting envelopes as a stand-alone investment as well as when coupled with various energy conservation measures (ECMs). Targeting a yearly percentage of the building stock managed by the DOD beyond the current scope will bring awareness and incite change. The reach of this study can affect policy change for worldwide implementation of standards to be established across domestic and international DOD installations to achieve targeted goals laid out by the executive branch to achieve net-zero building emissions by year 2045 (The White House, 2021). A holistic approach is key to reaching these climate goals, not only by focusing on the reduction of wasted energy but also the transition away from traditional fossil fuel energy sources to allow more sustainable options. Within the first tier of actions in the path toward operating at net-zero carbon building emissions, the DOD needs to ensure buildings are operating efficiently by reducing wasted energy and have sustainable preconditions prior to exquisite climate conscious energy upgrades to ensure these assets will last for years to come.

Funding for installation retrofit projects are often a challenge and will be investigated, as this is a real constraint faced with institutional change toward climate consciousness. There are many competing priorities for funds within the federal and DOD budget, and unfortunately, Operation and Maintenance (O&M) and base operating support

funds are typically insufficient to keep up with the deterioration of assets which is widely observed across installations and military housing establishments. Alternate funding streams are available and will need to be explored in conjunction with top-down policy to enable installation managers the chance to increase energy efficiencies and ensure longevity of building infrastructure.

B. BUILDING ENVELOPES

A building envelope is the physical barrier that separates the exterior uncontrolled environment from the interior controlled environment. It has been estimated that appropriate envelope design can reduce total energy consumption by 20–50% (Luo et al., 2019). There are two types of building envelopes: active systems which are technologically advanced and not as cost effective in retrofits and passive systems on which this paper will focus. The various components that make up a passive envelope include the roof, walls, windows, and floors. The thermal performance of a building is dependent on temperature and pressure differences between the interior and exterior atmosphere and the barrier that separates them. The performance of the envelope depends on both the materials and the integrity of the collective envelope system.

The methods of heat transfer through the envelope resulting in heat loss are conduction, radiation, and infiltration. Heat loss via conduction is observed through heat transfer through inefficient envelope materials while infiltration, or direct leakage, consists of heat transfer through a compromised envelope system. Radiant heat transfer can be observed through windows or skylights from the sun which heats up the conditioned air inside the building. Inefficient materials with poor insulation qualities, or a loose building envelope, result in heat loss through this barrier which is wasted energy that could be captured. Before energy efficient building methods and materials were introduced and standardized in recent years with energy and climate conscious consumers, building envelopes were not critically considered. Energy efficient construction requirements have been adopted and standardized in building code practices and written into procurement contracts as a growing awareness of climate impact and energy efficiency have evolved within the political environment.

Currently the DOD building stock is made up of many older buildings with 29% of them exceeding their expected lifetime use (Government Accountability Office [GAO], 2022). Many have been built before policies and building codes were established meaning a large portion will have unrealized inefficiencies wasting energy and resources by the supererogatory operation of HVAC systems due to inefficient envelopes and neglected material conditions. This study intends to highlight the important role of building envelopes in the pursuit toward reducing energy consumption and achieving a net-zero building portfolio by target year 2045.

C. STUDY ORGANIZATION

This paper is organized into seven chapters that present an overview of the current state of policy and infrastructure within the DOD and the obstacles on the path toward meeting energy efficiency goals. Through analysis of the current environment and a case study conducted at the Naval Postgraduate School (NPS) campus, this study illustrates the importance of envelope conditions and their impact to energy demand.

Chapter I introduced these issues and potential solutions that this study seeks. Chapter II discusses the background within the DOD in both policy and funding. This includes budget constraints, broad climate change initiatives, energy resilience goals, policy directives and guiding actions toward structured change for energy goals outlined by the DOD. Chapter II also presents a detailed literary review to provide a basis for this study from examples of building envelope elements as well as studies done across the globe to highlight their impact on energy efficiency. Chapter III provides a case study structure and methodology. Chapter IV presents the NPS case study results along with other case studies found in the literature. Chapter V dives into an analysis of the case study conducted on the NPS campus to prove the logic and effectiveness of building envelopes and supporting trends in data from a multiple case study analysis. Chapter V presents an analysis and discussion on the results from the multiple case study approach, expanding on potential avenues for funding projects and a critical analysis of limitations and assumptions to the case study presented, as well as potential policy implementation that could have far

reaching effects. Chapter VI offers the conclusion and potential follow-on research opportunities.

THIS PAGE INTENTIONALLY LEFT BLANK

II. LITERARY REVIEW

A. THE DOD ENVIRONMENT FOR ENERGY AND INFRASTRUCTURE

The federal government has been on an enduring mission to address energy and climate concerns. However, the focus has not always been toward energy, as the agenda shifts with the crises of the times. Energy use considerations within the government began with the establishment of the Federal Energy Management Program (FEMP) following the 1973 oil crisis (National Energy Conservation Policy Act, 1978). The crisis highlighted our reliance on the volatile imported energy market and provided the context for a new focus on energy conservation within the government. President Carter created the Department of Energy as a cabinet-level department in 1977 to address the energy crisis and to introduce policies in a national effort to reduce energy use (Wallechinsky, 2016). With the establishment of this pioneering department and program, vulnerabilities and weaknesses within the current energy policy structure were identified and legislation soon followed. To address the growing concerns on energy consumption the National Energy Act and the National Energy Conservation Policy Act (NECPA) were passed through Congress in 1977 and 1978, respectively (H.R.8444—95th Congress, 1977; National Energy Conservation Policy Act [NECPA], 1978). Legislation to effect systematic change within our nation toward energy conservation efforts had begun and has picked up momentum through executive action.

The National Energy Act and NECPA were crucial policy directives, intended to reduce energy demand and drive a culture shift toward energy conservation and awareness, not only within the government but the nation at large. The NECPA enabled this by the execution of the first energy audit along with the subsequent requirement of annual energy reports within the government. The now-measurable energy use data allowed the government to set energy performance targets for federal buildings and enabled the Department of Energy to identify problem areas for which to devise strategies to address. Retrofit requirements to improve energy efficiency were established and broad policy changes to address these issues were now measurable and actionable. Within the NECPA, the shift toward alternate and renewable energy sources was also introduced. The NECPA

declared that the Federal Government has the responsibility to promote the use of energy conservation tactics, introduce alternate energy sources such as solar heating and cooling and for research for renewable energy sources to supply federal buildings (NECPA, 1978). This drive toward awareness and transition away from conventional fossil fuel energy sources began in the 70s and continues today. These initial pushes and targets derived from the newly established energy departments ultimately launched the culture shift within the government toward energy awareness, conservation, and renewable energies. This culture shift resulted in a reduction of energy consumption by 48% from levels recorded in 1985 (Rebecca George, 2015). However, the transition to alternative energy sources is a challenge which began over four decades ago, proving to be an extensive and expensive endeavor.

Leading into the 21st century, the culture of energy had been fully embraced and the drive for new technologies and growing concerns of climate change drove the political agenda for further legislation. The Energy Policy Act of 2005 amended the NECPA by introducing new energy targets and provided billions of dollars for energy research and development programs that focused on energy efficiency and renewable energy projects which incentivized clean and efficient energy use (Energy Policy Act [EPA], 2005). Within the act, it provides key research and development directives aimed at buildings, “cost-effective technologies, for new construction and retrofit, to improve the energy efficiency and environmental performance of buildings, using a whole-buildings approach, including onsite renewable energy generation” (EPA, 2005, Title IX). Advanced metering and control devices were a crucial item that was derived from these actions which enables accurate energy use data. These meters provided data that is essential to find, fix, and track a wasteful building or system in almost real time. Advanced meters provide, at a minimum, hourly consumption of electricity in federal buildings which will be incorporated into Federal energy tracking systems that feed into annual energy audits conducted by the government (42 U.S.C. 8253—Energy Management Requirements, 2010). The Energy Policy Act directed managers to implement comprehensive energy use strategies and evaluations which enabled flexibility in financing for energy related projects.

Continual emphasis on the top-down implementation of climate conscious directives, policy, and funding is evidenced in multiple climate-focused Executive Orders (EO), bills, and inclusion of energy conservation projects within almost every National Defense Authorization Act (NDAA) since the early 90s (Greenley, 2019). In the current political climate, the trend continues with EOs issued by President Joe Biden beginning in 2021 along with an emphasized concern on climate change and energy within the Interim National Security Guidance (INSG). Each EO and policy directive has been instrumental in continuing the shift in culture as well as driving the federal response to climate mitigation and adaptation of energy conservation efforts. President Biden released the INSG in March 2021, which highlighted climate change as a critical national security issue. This was echoed by Secretary of Defense (SECDEF) Lloyd Austin III during the Leaders' Summit on Climate in April 2021 when he stated, "Today, no nation can find lasting security without addressing the climate crisis. We face all kinds of threats in our line of work, but few of them truly deserve to be called existential. The climate crisis does" (David Vergun, 2021, para. 1).

The INSG highlights climate change as a destabilizing force that is altering the operational environment and demanding mitigating action. The inclusion of these observations within the INSG is significant because this document establishes guidance from which all future federal policies, directives and budgets are derived. The INSG states: "We will use federal procurement to jumpstart demand for critical clean technologies like electric vehicles. And we will support the accelerated growth in renewable energy deployment, invest in climate friendly infrastructure, build resilience to climate change, modernize our energy grid, and provide the international leadership required to encourage countries around the world to do the same" (White House, 2021, p. 17). As world leaders and the second largest consumer of energy in the world, inspiration toward climate change from the United States is needed while near-peer nations are engaged in the great power competition that has accelerated the race toward building capabilities against national competitors. Rapid development and expansion has the potential to perpetuate the issues of climate change, which will to protract the advancement of clean energy and efficient practices. The International Energy Agency (IEA) is an organization created in 1974 after

the initial energy crisis and has been tracking energy demand and use following the crisis, and its data analysis predicts there will be a 27% increase in global energy demand by 2040 (International Energy Agency [IEA], 2021).

Various targets have been established through recent EOs to hasten the pace toward the goals that began in 1978. To supplement the overarching policy directives within the INSG, President Biden issued numerous EOs to design a path toward reaching a net-zero goal for our country by 2050. *EO 14008, Tackling the Climate Crisis at Home and Abroad*, directs action addressing climate change at the national and international level by requiring federal agencies to develop “Climate Action Plans” to outlines each agencies’ steps toward climate conscious adaptation of renewable energies and increased resilience to the impacts of climate change (Executive Order 14008, 2021). This EO is (in part) to prepare the armed forces for increased operational demands and degradation of infrastructure. *EO 14057: Catalyzing America’s Clean Energy Economy through Federal Sustainability* establishes measurable goals toward a net-zero emissions from overall federal operations by 2050 to include pacing milestones of a 65% reduction in emissions by 2030 and for a net-zero building portfolio by 2045 (Executive Order 14057, 2021). This continues to emphasize the need for the U.S. government to lead by example in climate change solutions and meet targeted goals. Reaching these desired goals requires a holistic approach that includes policy directed at the aged infrastructure and the energy sources used for power.

Most recently, in 2022, the Biden administration launched an initiative to modernize building codes, improve climate resilience, and reduce energy costs (The White House, 2022). This includes the implementation of the first-ever carbon emissions standards and tracking for federal building performance (The White House, 2022). This effort shows the role the government can play and the emphasis on retrofitting existing Federal buildings across the federal building portfolio.

To achieve targeted goals and carry out initiatives derived from the EOs, legislation, and service branch goals, each installation has a billeted energy manager. Energy managers are the action officers in charge of installation energy programs; they are guided by these policies and directives. They are responsible for managing each installation’s energy use, directing improvements on the facilities under their charge, and

implementing projects to meet these targeted goals. A guiding principle for building managers to consider is aimed at energy efficiency modernization projects on existing buildings. They are directed to conduct energy audits on their respective building stock, which are meant to cover 25% of all DOD facilities every year to ensure a full analysis is conducted on every building within a period of four years (DOD, 2009). This energy audit allows energy managers to identify target buildings for improvements to increase efficiencies on aged or inefficient buildings.

A large share of the DOD building stock is old and neglected (GAO, 2022). Regulations on new construction buildings have addressed the energy consumption issues identified from earlier legislation but has been limited to that; large-scale retrofit projects are only now slowly emerging. This does not address most of the DOD's building stock which was highlighted in a 2020 Government Accountability Office (GAO) report which identified 29% of the current building stock was built 60 years ago and has exceeded its lifespan (GAO, 2022). New requirements for future DOD projects on base installations under the Unified Facilities Criteria (UFC) require minimum specifications through building codes to ensure sustainable construction practices and ensure high energy performance standards on new construction projects. The UFC aims to enhance DOD mission capability by reducing total ownership cost (DOD, 2014). Unfortunately, the UFC do not apply to much of the current building stock of nearly 300,000 buildings located at over 4,700 installations in 80 countries, many buildings were likely built prior to UFC implementation (Conger, 2018). The building stock within the DOD at the target year 2045 will be mostly made up of older buildings not built to the new codes established by the UFC (CRS, 2019). This represents a substantial portion of the DOD's building portfolio and policy action is needed if DOD is to influence its energy use portfolio. This presents a challenge as the funding trend for facilities maintenance and sustainment is chronically below both required and requested levels; a funding analysis follows this section of the chapter. This is even more concerning since the buildings beyond their life expectancy are not accounted for in the building sustainment budget (GAO, 2022).

B. FUNDING ANALYSIS

Understanding the constrained financial environment in which the DOD operates is important when dealing with building upkeep and energy conservation retrofitting projects. Underfunding and a flawed financial estimate have led to systematic issues and challenges to meet target goals. This flawed funding system underestimates required funding levels to maintain facilities—and to exacerbate the issue, funding has been chronically below target levels for many administrations. Higher-priority requirements and more immediate risks get redirected funds that should have been allocated to building upkeep and maintenance. Over time, this has snowballed to a backlog of \$137 million identified within a GAO report in FY2020 (GAO, 2022).

1. Budget Model

The budgeting system currently in use is flawed as it does not give an accurate funding requirement to address the actual need. The Facilities Sustainment Model (FSM) is used to estimate the funding levels required to conduct facility condition assessments and maintain buildings in working order (DOD, 2007). The FSM funding model is flawed because it generalizes the buildings by square footage without the consideration of building conditions or age (GAO, 2022). Once the building has exceeded its life expectancy the funding estimates are inaccurate. The various components have replacement and repair expected timelines and the cost for the repair/replace is divided by the life expectancy of the building and included in the budget request; however, once the life expectancy has been exceeded, this analysis does not restart and the building is then no longer included in the cost analysis (GAO, 2022). The current DOD stock consists of 29% of facilities that have exceeded their life expectancy and are expanding the financial gap between the actual amount required and the requested funds (GAO, 2022).

To fully grasp the status of the funding required to get ahead of the growing backlog, it will require a full analysis of the current building stock and a financial modeling system that incorporates building age and condition. This has been identified and a new system will be released in 2025 called Sustainment Management System (SMS), it will account for buildings age, condition, and the effects of delayed repairs or replacements

(GAO, 2022). Gaining an accurate picture of our facilities' envelope conditions can lead to efficient use of funds toward the reduction of utility costs and ensure follow-on investment opportunities are fully captured when modernizing equipment and implementation of exquisite alternate energy systems. This will also lead to the demolition of inadequate buildings and ensure energy investments will meet return on investment (ROI) goals.

2. Appropriations

Even with a healthy budget by comparison to other federal agencies, the constrained fiscal environment within the DOD does not allocate funding toward the upkeep of the current stock of buildings or support extensive retrofits. Facilities sustainment and retrofitting has been chronically underfunded and is required to maintain a working infrastructure system from which our forces operate; it is essential to meeting the daily tasks and future missions. Under the O&M appropriation, the specific line item of Facilities Sustainment, Restoration, and Modernization (FSRM) is allocated to facilities upkeep. The direct funding by the agency is sourced from the FSRM and demolition program which is part of the larger O&M appropriation. This will be the primary means of funding for building envelope retrofit projects since this fund is directly tied to building upkeep. FSRM is defined by the three categories a project can fall into:

- “*Sustainment* means the maintenance and repair activities necessary to keep an inventory of facilities in good working order. It includes regularly scheduled adjustments and inspections, preventive maintenance tasks, and emergency response and service calls for minor repairs. It also includes major repairs or replacement of facility components (usually accomplished by contract) that are expected to occur periodically throughout the life cycle of facilities. This work includes regular roof replacement, refinishing of wall surfaces, repairing and replacement of heating and cooling systems, replacing tile and carpeting, and similar types of work. It does not include environmental compliance costs, facility leases, or other tasks associated with facilities operations.” (DOD, n.d., p. 8-1)

- “*Restoration* means the restoration of real property to such a condition that it may be used for its designated purpose. Restoration includes repair or replacement work to restore facilities damaged by inadequate sustainment, excessive age, natural disaster, fire, accident, or other causes. ices, grounds services, waste disposal, and the provision of central utilities.”(DOD, n.d., p. 8-2)
- “*Modernization* means the alteration or replacement of facilities solely to implement new or higher standards, to accommodate new functions, or to replace building components that typically last more than 50 years (such as the framework or foundation).” (DOD, n.d., p. 8-2)

With a plethora of competing priorities, the limited resources allocated to the DOD fiscal topline leaves many needs unmet. The DOD has chosen to accept risk within its facility portfolio as higher priorities present more of an immediate threat. The money allocated toward facilities has been historically underfunded and has left between one-fifth and one-quarter of facilities to degrade to poor or failing conditions (Jarad Serbu, 2018). The Under Secretary of Defense (Acquisitions and Sustainment) set a goal to fund facilities sustainment requirement at a minimum of 90% of the estimated total cost, yet that target has been chronically underfunded (GAO, 2022). The enacted amounts each year have historically been about 10% below the goal set forth by the Under Secretary of Defense (USD) (see Figure 1) (GAO, 2022).

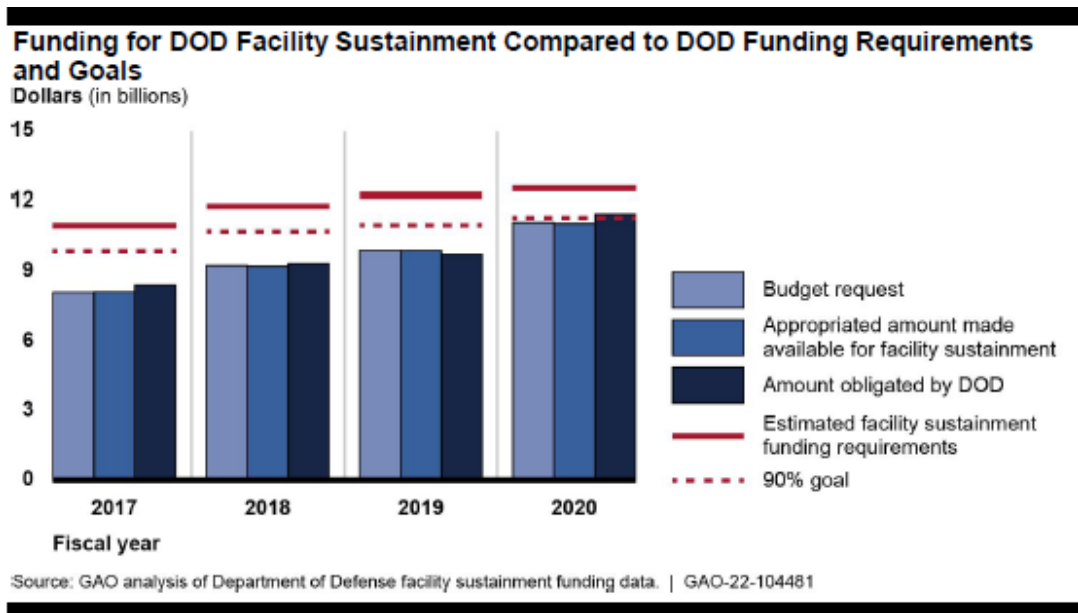

Figure 1. DOD Facility Sustainment Funding.
Source: GAO (2022)

In the FY 2023 budget, funding has aligned with the climate priorities outlined in the INSG and the neglected FSRM funds. The Secretary of the Navy (SECNAV) has highlighted in their Enduring Priorities the need to increase facilities sustainment, restoration, and modernization, which shows the great need to recoup lost ground in the battle to keep up with the aging facilities on Naval installations (Office of Budget, 2022). “The FY 2023 budget prioritizes critical shore investments, creating enduring advantages that increase fleet readiness. The FSRM program maintains the working order of our facilities inventory and prevents premature condition degradation of mission critical facilities, and strengthens vital infrastructure against impacts of climate change.” (Office of Budget, 2022, p. 4-17). This makes up for the inaccurate funding model presented by the FSM, but an accurate understanding of the problem is needed to close the gap.

The focus toward energy awareness in the budget is evident by priorities identified by government. Portions of the budgeted funds are going to the establishment of key leadership roles within the defense energy organization. In FY 2022, funding has been directed toward the defense wide O&M budget request to include a \$100.5 million increase to fund programs such as installation energy analyses and the establishment of the Assistant

Secretary of Defense for Energy, Installations, and Environment (Office of Budget, 2022). These new roles will hopefully drive changes within DOD installation management and fight for a larger topline budget. The additional funds are also designated to gain an understanding of the current state of buildings and will feed the new SMS model. Continuing this positive change toward facilities, an additional \$2 billion (FY 2021) was awarded across the service branches above the requested amount toward FSRM within the O&M appropriation, bringing the funding levels closer to the target (Office of Budget, 2022). This is leading toward directed investments by the service branches and a renewed focus toward facilities.

Some details of the increased allocation have been utilized by the Air Force aimed at their infrastructure investment strategy to restore readiness to installations. The FY 2023 budget has \$3.5 billion allocated to the Navy, which fulfills 85% of the requirement while the United States Marine Corps (USMC) FSRM funding fulfills only 56% at \$1.3 billion (Office of Budget, 2022). The reduced percentage of funds toward the Marine Corps is due to the Facilities Investment Strategy that the USMC has implemented as it begins to focus on eliminating old and unused buildings in its shift from sustainment to restoration and modernization of critical infrastructure with the goal to improve the overall building portfolio (Office of Budget, 2022).

Although the focus has shifted toward facilities, there remains a challenge of ensuring this money is executed effectively. The complexity of retrofit projects as well as high financial costs, present a barrier that has caused resistance in the past and these challenges remain. As observed by a 2017 Inspector General report, there is a challenge “tracking execution by function, measure outcomes, or to establish a link to readiness contributed and credibility issues in requirements justifications” (Inspector General, 2017). It was also identified by the GAO in 2016 which investigated the period beginning in 2009 and ending in 2015, stating, “[the] DOD did not report the anticipated return on investment or did not provide updates in subsequent notifications on the anticipated return on investment following scope or cost changes for about 21 percent (93 projects) of the 441 proposed projects for which it notified the congressional committees” (GAO, 2016). In today’s resource-constrained environment, the DOD must find creative ways to fund

projects aimed at the reduction of energy demand and to increase efficiencies to reduce overall O&M costs.

3. Alternate Funding Streams

To bridge the financial gap seen over the years, Congress established alternative financing methods available outside of the direct O&M appropriation. Aside from the FSRM funds, the use of performance contracts that allows the government to save up front costs were introduced with Energy Savings Performance Contracts (ESPCs) and Utility Energy Service Contracts (UESCs) to create diverse options for funds (CRS, 2018). In the latest FY 2022 budget, \$476 million has been appropriated across the DOD to continue to pay for current contracts and incentives for the creation of more energy saving contracts through these alternate funding methods. (Office of the Under Secretary of Defense (Comptroller), 2022).

An ESPC is a contract between the federal government and an energy service company (ESCO) who provides up-front capital costs for energy projects. It is an alternate financing tool to reduce energy use and maintenance costs, to modernize aging equipment, and to implement energy efficiency and renewable energy projects (DOD, 2019). Within these service contracts, the ESCO guarantees that the improvements implemented will generate savings sufficient to pay for the project over the term of the multi-year contract, which can be up to 25 years in duration. While the agency continues to pay the annual utility costs observed prior to the improvements for a fixed period of time, and at the conclusion of the contract the DOD reaps the benefits of lower utility costs thereafter as a result of the improvements (DOD, 2019). This concept of investment by the DOD to reduce O&M cash flows with this type of project funding is depicted in Figure 2. To quantify the amounts spend on ESPCs, in FY 2017 \$2.9 billion was awarded in ESPCs (CRS, 2019).

Similar to ESPCs, a UESC is a contract between the federal agency and the ESCO that provides funding for energy efficiency improvements. The ESCO finances energy related projects toward efficiency improvements and demand reduction services and the costs are repaid by the government over the length of the contract (CRS, 2018). The savings retained by the government in reduced utility bills are depicted in Figure 3. UESCs have

been around for more than 20 years and have awarded “nearly 2,000 energy and water efficiency renewable-energy projects, investing \$2.8 billion, and assisted the Federal Government in efforts to reduce energy intensity by more than 47%” (Niro, 2017, p. 1).

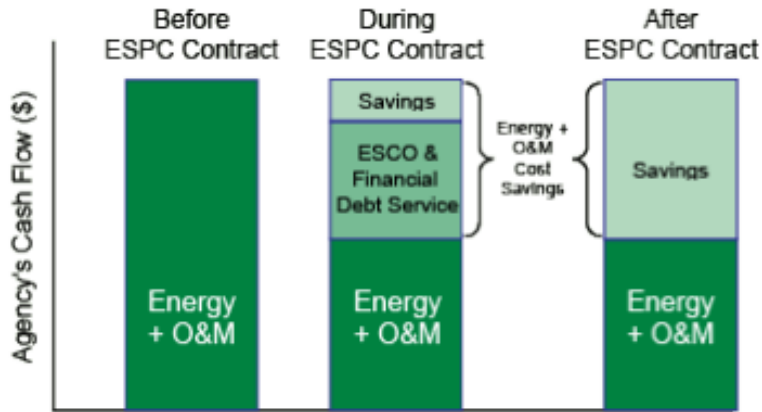

Figure 2. ESPC Cash Flows. Source: Tetreault and Regenthal (2011).

Utility Energy Service Contracts Reallocate the Government's Utility Bill

- Avoid costs
- Lower demand
- Pay for equipment
- Achieve cost savings for the Government

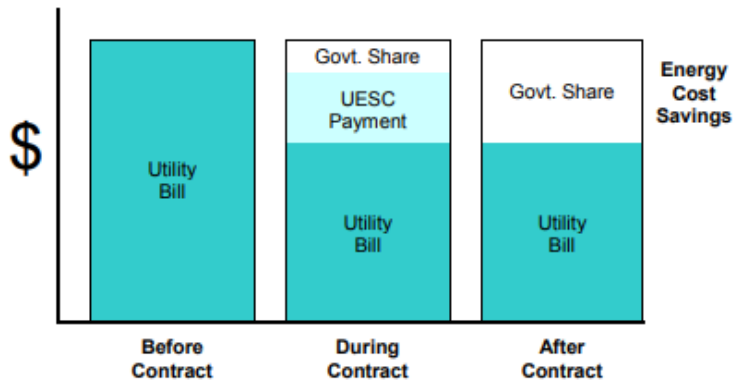

Figure 3. UESC Cash Flows. Source: Niro (2017).

The flexibility and purpose of the UESCs and ESPCs make them the likely choice for retrofitting projects with the constrained O&M appropriation. These alternate funding streams will need to be leveraged until the new SMS funding model is enacted and appropriations can be accurately funded. The intent behind UESCs and ESPCs is to reduce energy demand through projects which can include building envelope ECMs by ESCOs. This can expand the retrofit industry with increased demand which will hopefully reduce costs in the long term for projects through a network effect. However, utilizing these alternate funding streams requires significant training and management to effectively utilize. In a 2017 review conducted by the Inspector General on the use of UESCs at the Marine Corps base in Camp Pendleton, California, the proper implementation and tracking of contracts has proven to be difficult for the services (Inspector General, 2017). This report revealed that NAVFAC Southwest contracting officials did not properly administer or monitor 10 out of 10 UESCs valued at \$44.6 million for energy conservation measures on the USMC base Camp Pendleton. This created gaps in assurance that the DOD was getting what was contracted for and generating the savings equal to the agreed amounts (Inspector General, 2017).

C. BUILDING ENVELOPE EFFECTIVENESS

Despite the continual lack of funding and aged facilities in a deteriorated state, building envelope assessments and improvements should be prioritized to reduce utility costs, improve resilience to changing climates, and meet energy efficiency goals. Numerous research studies that focus on building energy confirm that it is necessary to enhance the performance of building envelopes to reduce energy consumption (Luo et al., 2019). Strategies focusing on technical solutions including building envelopes are well known and effective as evidenced by an examination of 178 case studies in the Buildings journal that identifies the vast majority include envelope improvements (Mirabella et al., 2018). This chapter includes literature revealing the effectiveness of building envelopes individually as well as within deeper retrofit strategies, case study examples, and estimation models to highlight the effectiveness in reducing energy and saving utility costs through building envelope improvements.

Important to consider is the order in which building improvements are implemented. There are a variety of energy conservation measures, and a sequential and holistic approach will prove to be the best use of limited resources. The ECMs aimed at building envelopes have the potential to reduce the required load on systems that operate in loose envelope environments (Department of Energy, 2004). For instance, if a project building were to replace a HVAC system prior to addressing the building envelope, the opportunity to reduce the size of the HVAC system will have been missed and unnecessary costs associated with a higher capacity HVAC system could forfeit additional ECMs due to cost. Implementing a robust envelope retrofitting project on an installation can help gain an accurate energy demand signal for investments into net-zero micro-grids on installation.

The most significant improvements to reduce energy consumption for an old building through retrofit are improvements to the envelope's thermal insulations, lighting, and glazing (Ardente et al., 2011). Building envelopes play a significant role in energy efficiency and is especially important with an aged stock of buildings with a history of neglected maintenance, as evidenced in the DOD portfolio. In an article presented at the international cold climate HVAC conference, it was stated that about 50% of heating energy is lost by heat transfer of the building envelope (Feng et al., 2016). While many of our installations are subject to cold weather, the climate continues to change, and the DOD must proactively adapt. Energy loss is not only observed in cold weather climates, in a study conducted in Egypt, it was shown that an average of 33% of energy use reduction can be realized with improvement to the building envelope (El-Darwish & Gomaa, 2017).

There are three factors to consider in deciding whether to demolish a building and rebuild or to retrofit an existing structure. The impacts to consider are the operational impact of either course of action, the cost effectiveness, and the carbon emissions from each process. Buildings are long-standing assets that have both direct environmental impacts along with the usually neglected external and indirect effects from the build process. These indirect effects are from sourcing materials in the initial construction to the demolition and disposal, which need to be considered if the aim is to reach carbon emission goals. In a study focused on the global environmental impact of buildings, the study showed that 40–60% of total life cycle energy is used in the production and construction

phases of a building (Ardente et al., 2011). Taking into consideration the governments net-zero goals, we must account for all contributing factors. This conflicts with a strategy dependent on demolishing and rebuilding infrastructure to current energy efficient codes to meet goals. The current trends seen within the DOD's building stock typically sees buildings exceed life-expectancy with insufficient funding to maintain, which means a substantial portion of buildings are candidates for retrofit projects which will make them more habitable as well as prolong their lifetime use. A retrofitting strategy is the best approach for reaching net-zero goals with a minimized environmental impact over the shortest duration of time when compared to demolition and reconstruction.

D. RETROFIT STRATEGIES

There are a multitude of strategies aimed at building envelopes retrofit projects that can be implemented to increase efficiencies. The Oak Ridge National Lab highlights the importance of retrofit strategies because “about 65% of U.S. buildings were constructed before the Department of Energy established the Building Energy Codes Program in 1992; therefore, their envelopes are likely significant contributors to heating and cooling loads” (Salonvaara et al., 2020, para. 1). Retrofit strategies are required to build resiliency within the DOD stock, focusing these retrofit efforts on the building's capacity to resist heat transfer and escape through the envelope will ensure longevity and cost saving over time. A building's energy consumption is largely dependent on the thermal performance of the building envelope, lighting, and glazing (Ardente et al., 2011). Examples of these effective retrofitting measures include installation of exterior wall insulation, roof insulation, reducing air infiltration, highly reflective paint on external roofs/walls, multi-pane window glazing, solar shading, heat sinks, and other new adaptations emerging within the industry. Each strategy has levels of cost that are tied to pay-back periods which are a key metric in the decision for a retrofit strategy. Many of these passive technologies have been refined and proven their effectiveness resulting in their wide use within the industry around the world which has reduced costs and can be leveraged through economies of scale with installation wide implementation.

The Department of Energy highlights various components and their impact to the reduction of energy intensity. A technological review of the current technologies available today indicate that a combination of ECMs could significantly reduce heating demand by 77% (Department of Energy, 2015). The graphical representation signals the importance of building envelopes in Figure 4.

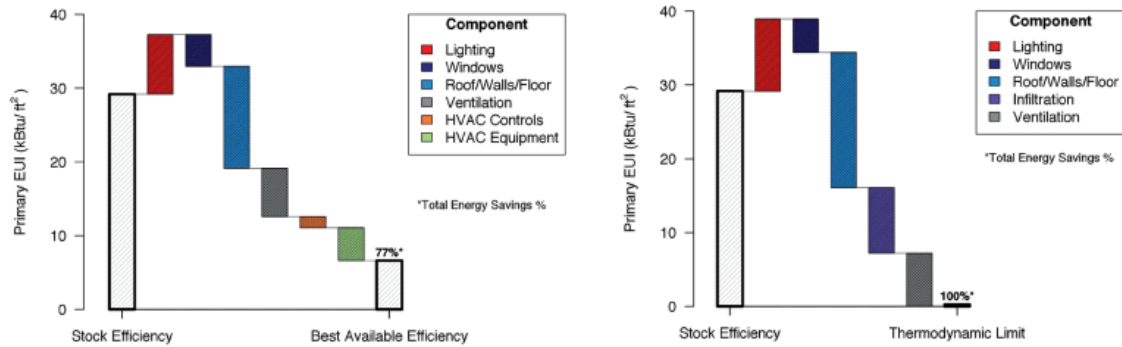

Figure 4. Energy Efficiency of Commercial Buildings Gained with Best Available Components. Source: Department of Energy (2015).

When coupling building envelope improvements with other ECMs, energy savings are observed that far exceed what envelope improvements can produce on their own. The Department of Energy conducted a case study within a large group home which was built in 1900, observing poor initial conditions and a poor building envelope. Installation of double pane windows, improves ceiling insulation combined with ventilation duct repairs and lighting upgrades saw a 44% reduction in energy saving (Department of Energy, 2012). This project showcased the implementation of minimally invasive retrofit measures that were readily available and cost-effective.

1. Windows/Glazing

When looking at retrofit measures to address, identifying the largest contributor to heat loss can lead to significant changes in envelope performance. Windows account for a large portion of energy loss identified in various studies, estimated to be within a range

between 20–60%, largely depended on building size, age, and type (Moghaddam et al., 2021). The two principal factors to consider with window performance is their solar and thermal resistance properties. Solar resistance is the window’s ability to deflect direct heat from the sun while thermal resistance refers to the heat transfer properties from either the controlled or uncontrolled environments across the window’s plane. Windows have been proven to be the most effective retrofitting method because they account for the highest heat transfer U-value and the largest gains are noted through multi-pane glazing. The latest technology developed to improve energy efficiency of windows includes introducing multiple layers of glass panes with a cavity between the panes as depicted in Figure 5. This cavity is filled with special types of insulating gas such as argon, krypton, or xenon to reduce the heat loss through the window (Mohelníková & Altan, 2009). Each of these gases display different effectiveness when coupled with glass thickness as depicted in Table 2. Multi-pane windows incorporate a wide range of technologies including solar control glasses, low emissivity (Low-E) coatings, and aerogels which when coupled with the additional layer of gas the multiple glass segments maximizes energy performance.

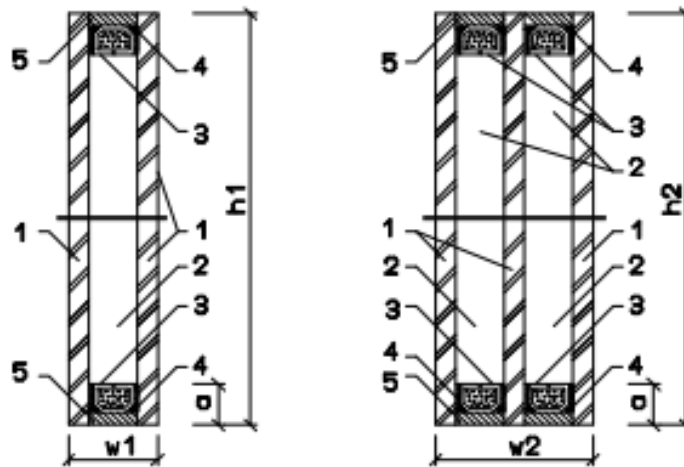

Scheme of a double and triple glazed unit. #1: Glass pane, #2: Cavity, #3: Distant edge profile, #4,5: Sealants.

Figure 5. Cross Section of Window Glazing. Source: Mohelníková and Altan (2009).

Table 1. Various Glass U-Values. Adapted from Aguilar-Santana et al. (2020).

Glass Configuration	U-value (W/m ² K)
Uncoated single glass 6 mm	5.70
Uncoated double glass 12 mm cavity	2.80
Uncoated double glass 15 mm air cavity	1.40
Uncoated double glass 15 mm argon cavity	1.20
Uncoated triple glass 16 mm with argon	0.79
Uncoated double glass 22 mm monolithic aerogel	0.65
Uncoated double glass 33 mm granular aerogel	0.44

Major advances in window technology have matured over the last few decades. to include a wide range of possible retrofit improvements that do not require destruction and replacement of the old window unit. Window replacements can become costly with a long pay-back period which has led to the development of solar shading via blinds and drapes, insulated cellular shades, window films, and awning installation.

2. Window Films

Window films have proven to be effective in reducing 6–20% of annual energy consumption with various types of products available when observed in various case studies (Moghaddam et al., 2021; Amirkhani et al., 2019). These products range from simple tinting to reduce the solar transmittance to more high-end low emissivity (Low-E) films which reduce the heat transfer coefficient. To achieve a lower emissivity through the glass, Low-E coated glass is manufactured with a thin transparent coating made from metal oxide such as tin, silver, or zinc (Aguilar-Santana et al., 2020). The National Research Council Canada investigated two types of low-E coatings that are available in hard-coat and soft-coat, each saving up to 13–17% or 8–10% energy savings respectively (Laouadi et al., 2008). The thermal performance improvements are achieved by reflecting the longwave infrared radiation from both outside and inside, effectively trapping the heat from

exiting the controlled environment and trapping the controlled heat from radiating through the envelope as depicted in Figure 3.

Issues with window films and considered a drawback, are installation and maintenance requirements. This is due in part to improper installation that leads to bubbles and degraded performance and replacement due to deterioration. When funds are not adequate for a multipaned window, films should be run through a simulation tool to analyze cost-benefit as they are most effective on single pane windows (Moghaddam et al., 2021).

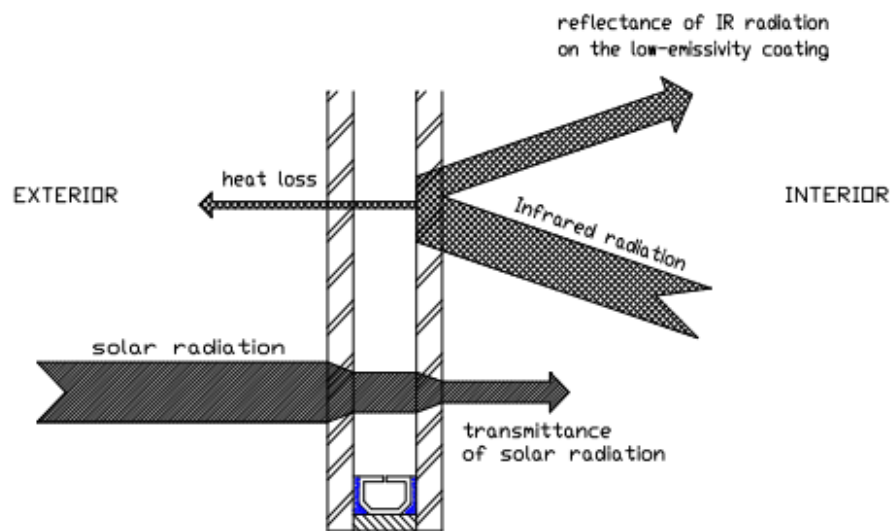

Figure 6. Function of Low-e Glazing. Source: Mohelníková and Altan (2009).

3. Solar Shading

Simply installing solar shades around the window has proven to reduce heat loss from the controlled environment inside of a building. This can range from external overhangs, low shading glass, adjustable louvers, to basic Venetian blinds which all have observed energy savings. Venetian blinds were used to cover windows in a study done in Canada, which observed a reduction by 10–12% from daytime cooling energy compared to an uncovered window (Laouadi et al., 2008). Similarly, in the same study, opaque exterior shadings consisting of white plastic panels reduced the energy use by 70% when compared to no blinds at all (Laouadi et al., 2008). In a multiple case study analysis

conducted in Egypt, it was found that solar shading via metal louvers on the exterior of the windows accounted for a range of 23–52% reduced energy use (El-Darwish & Gomaa, 2017).

4. Solar-Reflective Paint

Cool-wall and cool-roof solar-reflective paint on the exterior of a building in hot climate areas has resulted in improved thermal performance by reflecting heat from the sun as depicted in Figure 7. This retrofit measure is limited to hot climates. This has been evaluated and found to be an effective ECM in the United States, United Kingdom, Portugal, Spain, Greece, the Mediterranean region, Egypt, France, Turkey, Jordan, and Kenya (Celniker et al., 2021). This is important because DOD installations can be found in many countries in different climates. Solar reflecting paint improves the effectiveness of the building envelope and improved HVAC performance at a low cost and minimal impact to inhabitants. To determine cool-surface savings, a survey of the current building’s solar reflectance is required which can be gathered from thermal infrared and color photos, Landsat 8 images and light detection and ranging (LiDAR) via planes or even Sentinel 2A earth-observation satellites (Alchapar et al., 2020). The best results are from the least-insulated surfaces, typically walls, which in various case studies revealed savings between the ranges of 17–21% (William et al., 2021). Another study found similar results on low-insulated roofs with reducing energy consumption for summer cooling months by 25% (Casini, 2016).

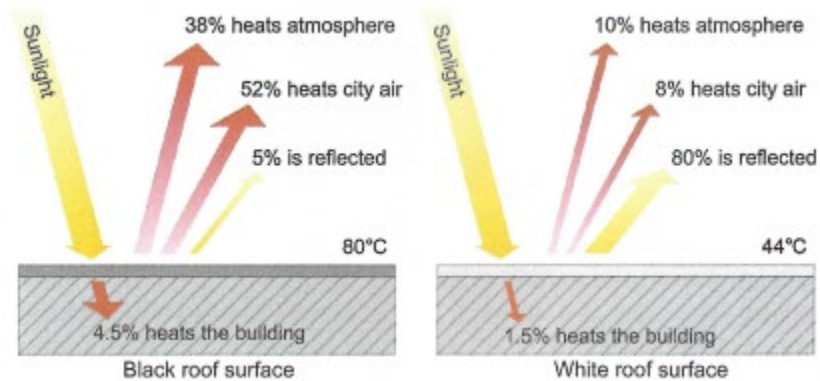

Figure 7. Solar reflective roof paint. Source: Casini (2016).

5. Insulation

Insulation is material added to the structure to resist heat transfer. This is limited by the amount of space between framing materials. There are several types of insulation with various “R” values which represent the materials thermal resistance per unit area. In a case study done in a controlled environment on experimental buildings in China observed 60–80% total heat loss due to heat transfer through uninsulated walls (Meng et al., 2018). Materials can be fiberglass, mineral wool, polystyrene, polyurethane, and other low heat transfer materials. In the same study conducted in China, it was recognized that life cycle costs were cut by 20% when the HVAC was run continuously, and 15% when used intermittently, noting the optimal thickness of materials varied between 3–5cm (Meng et al., 2018). A case study conducted in Egypt was able to achieve 8–15% reduction in energy use when they isolated the ECM effects of insulation (El-Darwish & Gomaa, 2017).

6. Cladding

One of the most cost-effective methods to improve the buildings envelope that has been identified by the Department of Energy are overlaid panels. Over cladding is defined as covering an existing exterior wall with a new layer of material to decelerate heat transfer (Michael Chafetz, Douglas Pac, 2020). The cost effectiveness and minimal impact to building occupants make this method attractive for the large scale of potential retrofit projects within the DOD. Advancements in this technology and the ability to be fabricated in mass quantities reduce costs for end users (Salonvaara et al., 2020). Aside from introducing a thermal insulator, this new exterior wall will enhance the aesthetics of the building. Compared to traditional insulation materials, a study on cladding revealed improvements of thermal resistance to heat transfer twofold (Salonvaara et al., 2020).

7. Air Tightness

Air tightness is a major contributor to the overall building envelope. If the air tightness of the envelope is loose, the measures taken to reduce heat transfer will be nulled since the air will find its way past the energy conservation measure rather than through it. Air tightness is measured in air changes per hour and a study conducted in Lithuania, 20% of the heat loss was due to infiltration of external air (Šadauskienė et al., 2014). This same

study showed that properly sealed and insulated buildings can save up to 50% heating energy and ensures a controlled and comfortable environment (Šadauskienė et al., 2014). This metric is dependent on the condition of the building and will vary from case to case. Typical areas where air leakage is common are found around windows and doors, electrical and plumbing runs through barriers, junctions separating walls, ceiling, and floor. This can be addressed with low-cost solutions such as spray foam insulation and injections of materials into walls.

E. EMERGING TECHNOLOGIES

The Department of Energy has been funding various organizations and small businesses to experiment with breakthrough technology in the retrofitting and building envelope sector. The Advanced Research Projects Agency-Energy (ARPA-E) is the leading edge of energy technology and their funding for year 2021 reached \$175 million which was distributed to 68 selectees across 22 states to incite novel approaches to clean energy and efficiency projects (Department of Energy, 2022). ARPA-E has funded \$30 million for advancements in single-pane highly insulating efficiency lucid designs program, focused on retrofitting older buildings (Department of Energy, n.d.a.). The Department of Energy has also awarded \$31.8 billion for a multitude of projects across the country to advance low-carbon building retrofit solutions (Department of Energy, n.d.b.).

1. Thermally Anisotropic Composites

Thermally Anisotropic composites (TACs) are both easy to use and minimizes the impact to current occupants. The DOE has funded a project aimed at designing an anisotropic thermal management system for existing and new building envelopes to reduce heating and cooling loads (Department of Energy, 2019). This is done by installing metal foil and insulation to the exterior of an envelope to create a heat sink that draws the heat flow away from the surface and directs it away from the controlled environment as depicted in Figure 8.

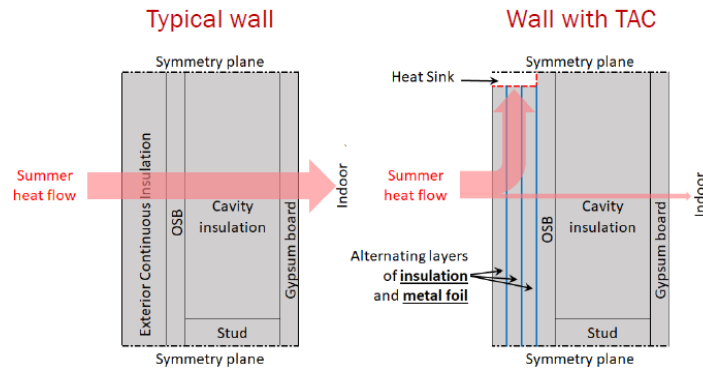

Figure 8. Novel TAC envelope design. Source: Department of Energy (2019).

2. Insulation-inflatable Walls

Oak Ridge National Laboratory in Tennessee was funded by the DOE for a project that experimented with an insulation-inflatable wall that improves the performance of insulation retrofits and will significantly reduce costs for retrofitting projects. This is conducted by a quick site visit to take measurements of the wall that is to be retrofitted to ensure the inflatable polymer structure created at a factory is the right size and shape. The final step consists of placing inflatable wrapper on the exterior wall and filling it with high R-value polyurethane, which will cure and form a rigid and permanent structure around the building, and then holes will be cut for windows and doors (Department of Energy, 2020). This is a cost effective emerging technology that finds cost reductions in transportation of materials since it is inflatable, the cost of the insulating material, and the production time by using automation (Department of Energy, 2020).

3. PV Envelope

Building integrated photovoltaics (PV) have been introduced and implemented within the building envelope system. This works to both reduce wasted energy and offset fossil fuel derived energy sources by providing its own energy for the building. The current technological advances have enabled PV to integrate on the outer surface of the building envelope, similar to cladding, to add an additional layer to the envelope that also has a power generating function along with the thermal barrier. The integration has been seen

installed on the roof, walls, as shading screens, transparent closures, and others elements as the technology advances (Casini, 2016). A visual representation is depicted in Figure 9.

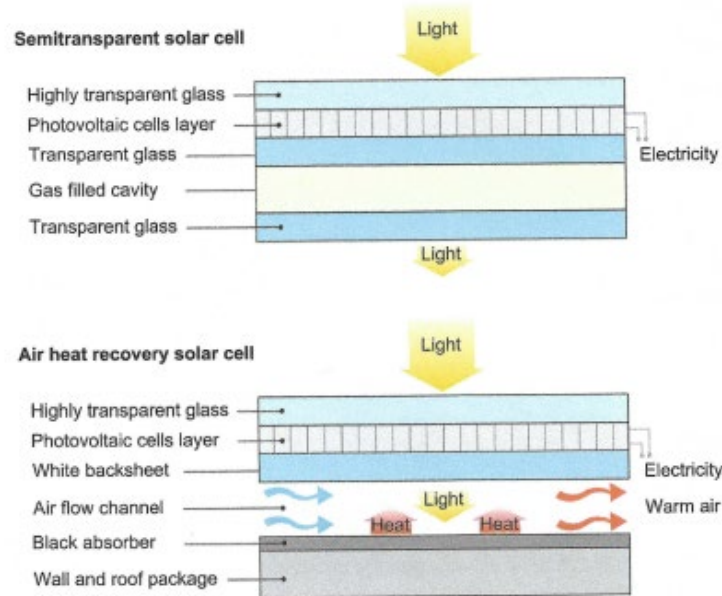

Figure 9. PV Envelope. Source: Casini (2016).

4. Phase Changing Material

Phase changing material (PCM) integration refers to emerging smart materials that can withhold latent heat and accumulate thermal energy through phase change to be released later. PCM works by taking advantage of the phase transition to absorb or release latent heat without increasing the materials internal temperature (Casini, 2016). This technology has been becoming more popular as reduced energy consumption has been observed This application has been used in various building envelope elements to include retrofitting measures such as existing walls through interior insulation systems, the inner lining of walls, ceiling tiles, as well as exterior walls, floors, roof linings, and windows (Casini, 2016). Ceiling tiles are particularly interesting within the DOD as a retrofitting option since it can cover the entire overhead and utilized existing infrastructure for minimal labor costs and intrusion.

5. Green/Living Walls

By utilizing vegetation as an exterior skin in the same manner as exterior cladding, buildings can provide more efficiency and blend into the surrounding environment by enclosing the structure with living plants. Green/living wall systems are commercially available and in experiments have shown energy reductions of up to 50% compared to buildings without any shielding device (Casini, 2016). This approach can both reduce energy consumption as well as give the building a fresh and aesthetic appeal, and within the context of the DOD it could serve as a camouflage to hide buildings. Green/living wall systems can be leveraged for buildings in sensitive areas, such as Hawaii or Guam, where the DOD footprint carries resistance and environmental impact is highly considered (Nguyen, 2021). Given the strategic locations for DOD installations, consideration of innovation and the surrounding environment can increase cooperation. Green walls not only reduce energy consumption, but have been observed to reduce pollutants that are dangerous to human health such as nitrogen oxides and particulates by 40–60% as well as provide sound insulation of 18 dB (Casini, 2016).

These living walls are made up of a highly technological growing medium made from expanded polyurethane foam between layers of polyamide felt which houses an irrigation system to keep plants watered and feed nutrients to ensure low maintenance requirements (Casini, 2016). Variations of these walls are depicted in Figure 10.

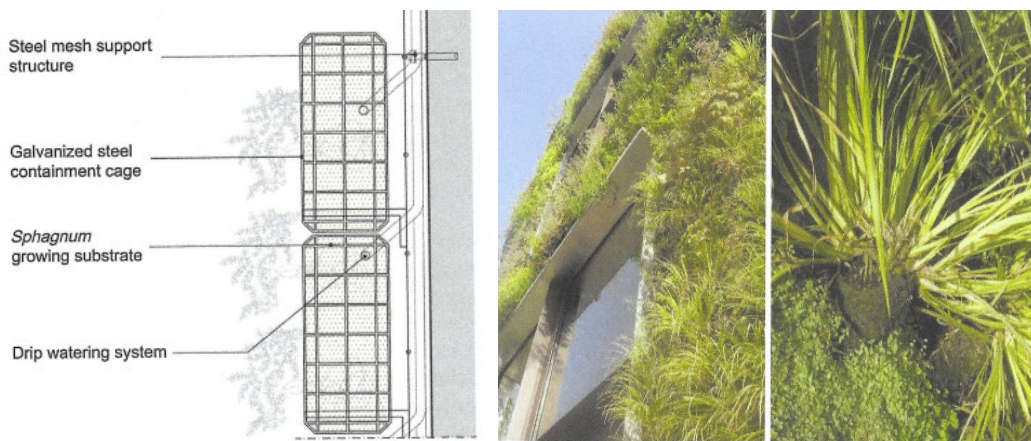

Figure 10. Green/living wall system. Source: Casini (2016).

F. METHODS FOR PROBLEM IDENTIFICATION

Before a retrofit project commences, an understanding of the current state of the building is required since these retrofit projects are not “one size fits all” solutions. The most common benchmark is related to building size and the annual energy use divided by the heated floor area or by volume (Roulet et al., 2002). EnergyStar has implemented a benchmark that is utilized for government facilities and expressed as energy intensity. “Energy intensity is calculated by dividing the total energy consumed by the building in one year (kBtu or GJ) by the total gross floor area of the building (square feet or square meters)” (Energy Star, n.d., para 2). This is a good benchmarking tool to get a general assessment, but there are other tests to investigate poor energy performance to identify where the weakness lies within the envelope. The various tests available are pressure tests, unmanned aerial vehicle (UAV) thermal imagery and handheld thermal imagery, smoke tracing, satellite imagery, or basic visual inspections. Simulations are available to run an estimate for a particular building as well as simulate retrofit costs and energy savings expected. This plays a significant role in cost-benefit analysis for a building’s retrofitting strategy.

III. METHODOLOGY

A. MULTIPLE CASE STUDY ANALYSIS

The focus of the research conducted was to prove that building envelopes play a crucial role in energy efficiency through a positivist approach. Data collection was required to provide a proof-of-concept, by utilizing real energy use data to estimate the cost an installation incurs if building envelopes are ineffective or have deteriorated along with the potential savings on utility usage. The aim is to highlight the potential energy reductions and cost savings that can be captured from building envelope retrofits and tie these gains with potential downstream benefits. This research utilized a multiple case study design approach. Yin, a prominent authority on the subject of case studies, defines them as “an empirical inquiry that investigates a contemporary phenomenon in depth within its real-life context” (Yin, 2009). Yin also includes in his definition, a point on data, “The case study inquiry copes with the technically distinctive situation in which there will be many more variables of interest than data points, and as one result relies on multiple sources of evidence, with data needing to converge in a triangulating fashion” (Yin, 2009). By the triangulation of various case studies, this study aims to prove that there are downstream benefits for investing in building envelope efficiency within our aged DOD infrastructure portfolio.

The following sections within this chapter will explain the research philosophy and the design of the multiple case analysis, the data collection strategies, along with the analysis method. The limitations and constraints observed in this specific case study will also be discussed.

B. DESIGN OF CASE STUDIES

This study is meant to be a combination of the quantitative and qualitative approach through the analysis of multiple case studies to use empirical data in a confirmatory approach. This was chosen due to the established theory that building envelopes effect energy consumption thought various well known studies (Feng et al., 2016; Šadauskienė et al., 2014; William et al., 2021). This study aims at confirming previous studies results

through multiple case studies in literature as well as a case study conducted on the NPS campus to provide both the empirical data to confirm the effect of building envelopes and feed the narrative toward their importance. The prime driver of the case studies is to showcase the effect the building envelope has on energy consumption. To accomplish this, buildings on campus were chosen to analyze the energy consumption from a breached envelope in relation to building characteristics. The envelope was breached to show the difference in energy consumption to infer the potential savings that could be captured if efficient building envelope retrofits were to be implemented on these buildings.

To test the theory of the effect on energy consumption, a range of buildings were chosen based primarily on age and size. This method was chosen to ensure the data could be representative to the buildings within the diverse DOD inventory. Data was collected from buildings that were built prior to the UFC building standards (implemented in 2002) which required energy conscious design, as well as case on a building built after the implementation to analyze a difference in energy intensity. These selected buildings were constrained to a short availability to minimize the impact to the building's occupants as well as their impact to the data. To reduce the impact, the number of days within the data collection periods were brief and confined to the weekends or when the building would be free from the impacts of the users of the building. However, this limitation does not affect the purpose of the study as it is both quantitative and qualitative and to highlight the benefits from building envelopes and the potential downstream benefits rather than provide exact energy or fiscal waste for specific buildings.

Data was collected in 2022 during the months of April and May in Monterey, California. This two-month range was due to time constraints within the project window; however, there is a significant heating demand for buildings nearly year-round on the NPS campus which includes the observed periods. The collection range was over a period of six days in total for each building. Each three-day portion was dedicated to analyzing the building with the independent variable being manipulated, this being the envelope. The case study was limited in the approach of design by only manipulating one element. The envelope element that was manipulated was the air tightness of the subject buildings. This was chosen because it was the least impactful to the normal use and the easiest variable to

manipulate within the buildings' envelope system. For each building, a various number of windows or doors were opened to simulate an ineffective envelope. This number of windows opened was minimized to about 20% of the facade's total number of windows and doors for each building to not exaggerate the ineffectiveness of the envelope. The dependent variable in this study was the observed energy (in kWh) use during both periods and for comparison. The measurements of energy use were gathered from either the building's local multifunction meter or a remote meter that collects data every 15 minutes. This was dependent on the installed systems availability.

The data collected from each case study provided a system to look at the buildings individually as well to as a collective to correlate the findings to test the theory that the building envelope plays a crucial role in energy consumption. The data gathered from each three-day period of manipulation of the independent variable was extrapolated to estimate the difference of yearly energy consumption between the two building states. This was then analyzed with the average cost of utilities in Monterey County during the time of the case study.

The data was correlated to other studies performed outside of this case study to confirm the effectiveness of a building envelope in relation to energy consumption. Although this method does not provide a granular dissection of numerical data over the course of a long period with varying environmental conditions observed throughout the seasons, the purpose of this study is to provide a proof-of-theory and to explore the benefits of focused efforts toward retrofitting the aged DOD building stock.

THIS PAGE INTENTIONALLY LEFT BLANK

IV. CASE STUDY RESULTS

A. OVERVIEW

This chapter will present various case studies conducted both at NPS as well as other case studies conducted across the United States, Egypt and Spain. The case study conducted on the NPS campus will be examined in depth as it was conducted in conjunction with this paper and the other case studies will be used to both compare data as well as correlate results to a full analysis and recommendation. Utilizing various studies will provide a larger cross section of envelope data as the NPS case study only collected data on one of the many building elements that comprise the envelope.

B. NPS CASE STUDY

This section will provide the data gathered from three buildings used in separate case studies to gauge the effect the building envelope has on energy consumption. It is broken up into three different buildings that have been chosen to cover a range of ages and sizes to compare, contrast, and identify trends. The data presented will be separated and individually presented for analysis in the following chapter. Each of the buildings had their envelopes manipulated for a period and energy data collected which was compared against a baseline when the envelope was sealed. The buildings' general details are outlined starting with the oldest buildings in chronological order as to when they were built.

- Building 1: Dudley Knox Library (BLDG 339)
 - Age: Built in 1971 (51 years old)
 - Size: 93,070 sqft
- Building 2: ME Lecture Hall (BLDG 255)
 - Age: Built in 1994 (28 years old)
 - Size: 2,480 sqft
- Building 3: Reed Hall (BLDG 310)
 - Age: Built in 2011 (11 years old)

- Size: 12,826 sqft

1. Building 1: Dudley Knox Library (BLDG 339)

The library was built in 1971, which makes it the oldest building in the case study. It was also the largest building of the three at 93,070 square feet. This building was built prior to UPC standards, and no envelope retrofits have been accomplished. A constraint with the library was occupant use, to which the observable times needed to be adjusted to minimize the impact on energy consumption from occupant's use of the facility such as computer use and other variables not in control or related to the building envelope. The envelope was manipulated by opening roughly 25% of the windows to simulate a poor envelope by window count. The data was collected from a local meter.

The period of control was 06MAY2022 (1200) – 09MAY2022 (0800) for a duration of 68 hours. The temperature during this time observed an average high/low of (62.25°F/52.25°F) with peaks at (71°F/46°F) respectively. The energy consumed during this period was 4,238.9 kWh. This is extrapolated over a year to get estimate consumption per year.

$$4,238.9 \text{ kWh} \div 68 \text{ hours} = 62.34 \text{ kWh per hour}$$

$$(62.34 \text{ kWh per hour} \times 24 \text{ hours}) \times 365 \text{ days} = 546,098.40 \text{ kWh per year}$$

The period observed with a breached envelope was from 13MAY2022 (1200) – 16MAY2022 (0800) for a duration of 68 hours. The temperature during this time, observed an average high/low of (61°F/47°F) with peaks at (61°F/45°) respectively. The energy consumed during this period was 4,475.05 kWh. This is extrapolated over a year to get estimated consumption per year.

$$4,475.05 \text{ kWh} \div 68 \text{ hours} = 65.81 \text{ kWh per hour}$$

$$(65.81 \text{ kWh per hour} \times 24 \text{ hours}) \times 365 \text{ days} = 576,495.6 \text{ kWh per year}$$

The contrast between the two sampling periods indicates the energy consumed due to the independent variable being manipulated, identified as the building envelope element

of air tightness. A rate of 3.47 kWh an hour increase was observed in energy consumption, which was translated to an increase of 30,397.2 kWh per year.

The cost per year is estimated using the average cost for utilities in California which is \$0.25 a kWh.

$$30,397.2 \text{ kWh} \times \$0.25 \text{ per kWh} = \$7,599.30 \text{ a year}$$

Table 2. Building 1: Dudley Knox Library (BLDG 339)

	Baseline	Poor envelope	Delta
Avg. Temp.	57.25° F	54° F	3.25° F
Rate (per hour)	62.34 kWh	65.81 kWh	3.47 kWh
Yearly consumption	546,098.40 kWh	576,495.6 kWh	30,397.2 kWh
Cost @ \$0.25/kWh	\$136,524.60	\$144,123.90	\$7,599.30

The difference of energy consumption observed between the two conditions saw an increase of 5.6% when the envelope was breached.

2. Building 2: ME Lecture Hall (BLDG 255)

The ME lecture hall was built in 1994 and is 28 years old, which is the median age of the buildings in the case study. It was also the smallest building of the three at 2,480 square feet. This building was built prior to UPC standards, and no envelope retrofits have been accomplished. The windows are single pane and there were observable gaps between the front windows of the building allowing air infiltration. This building was under full control for the duration of the data collection periods. The envelope was manipulated by opening roughly 25% of the windows by count, to simulate a poor envelope. The ME auditorium was equipped with a remote monitoring system where readings were gathered.

The period of control was observed from 25APR2022 (0000) – 28APR2022 (0000) for a duration of 72 hours. The temperature during this time observed an average high/low of (61.33°F/50.°F) with peaks at (64°F/48°) respectively. The energy consumed during this period was 184.91 kWh.

$$184.91 \text{ kWh} \div 72 \text{ hours} = 2.57 \text{ kWh per hour}$$

$$(2.57 \text{ kWh per hour} \times 24 \text{ hours}) \times 365 \text{ days} = 22,513.20 \text{ kWh per year}$$

The period that the envelope was breached 21APR2022 (0000) – 24APR2022 (0000) for a duration of 72 hours. The temperature during this time observed an average high/low of (62°F/50.67°F) with peaks at (64°F/48°F) respectively. The energy consumed during this period 194.45 kWh.

$$194.45 \text{ kWh} \div 72 \text{ hours} = 2.70 \text{ kWh per hour}$$

$$(2.70 \text{ kWh per hour} \times 24 \text{ hours}) \times 365 \text{ days} = 23,652 \text{ kWh per year}$$

The contrast between the two sampling periods indicates the energy consumed due to the independent variable being manipulated, identified as the building envelope element of air tightness. A rate of 2.70 kWh an hour increase was observed in energy consumption, which was translated to an increase of 23,652 kWh per year.

$$2.70 \text{ kWh} - 2.57 \text{ kWh} = 0.13 \text{ kWh per hour}$$

$$23,652 \text{ kWh per year} - 22,513.20 \text{ kWh per year} = 1,138 \text{ kWh per year}$$

At this yearly rate, the cost per year is estimated using the average cost for utilities in California which is \$0.25 a kWh.

$$1,138.8 \text{ kWh} \times \$0.25 \text{ per kWh} = \$284.70 \text{ a year}$$

Table 3. Building 2: ME Auditorium (BLDG 255)

	Baseline	Poor envelope	Delta
Avg. Temp.	55.7° F	56.3° F	0.6° F
Rate (per hour)	2.57 kWh	2.70 kWh	0.13 kWh
Yearly consumption	22,513.20 kWh	23,652 kWh	1,138 kWh
Cost @ \$0.25/kWh	\$5,628.30	\$5,913.00	\$284.70

The difference of energy consumption observed between the two conditions saw an increase of 5.1% when the envelope was breached.

3. Building 3: Reed Hall (BLDG 310)

Reed Hall was built in 2010, which makes it the newest building in the case study. This building was built after the implementation of UPC standards and was designed with energy efficiency in mind. This consisted of insulated 8” concrete walls and double pane windows that were permanently in the closed position with solar shading available with remote controlled shades. By size, this building is at the median for this case study at 12,826 square feet. The envelope was manipulated by opening about 10% of the opening due to limited available windows or doors. The data was collected from a local meter at the building site.

The period of control was observed from 04APR2022 (0700) – 07APR2022 (0700) for a duration of 72 hours. The temperature during this time observed an average high/low of (69.3°F/53.8°F) with peaks at (82°F/48°) respectively. The energy consumed during this period was 624.88 kWh. This is extrapolated over a year to get estimate consumption per year.

$$624.88 \text{ kWh} \div 72 \text{ hours} = 8.68 \text{ kWh per hour}$$

$$(8.68 \text{ kWh per hour} \times 24 \text{ hours}) \times 365 \text{ days} = 76,036.8 \text{ kWh per year}$$

The period that the envelope was breached 01APR2022 (0700) – 04APR2022 (0700) for a duration of 72 hours. The temperature during this time, observed an average high/low of (62.7°F/48.7°F) with peaks at (66°F/46°F) respectively. The energy consumed during this period 673.36 kWh.

$$673.36 \text{ kWh} \div 72 \text{ hours} = 9.35 \text{ kWh per hour}$$

$$(9.35 \text{ kWh per hour} \times 24 \text{ hours}) \times 365 \text{ days} = 81,906 \text{ kWh per year}$$

The contrast between the two sampling periods indicates the energy consumed due to the independent variable being manipulated, identified as the building envelope element of air tightness. A rate of 0.67 kWh an hour increase was observed in energy consumption, which was translated to an increase of 5,869.2 kWh per year.

At this yearly rate, the cost per year is estimated using the average cost for utilities in California which is \$0.25 a kWh.

$$5,869.2 \text{ kWh} \times \$0.25 \text{ per kWh} = \$1,467.3 \text{ a year}$$

Table 4. Building 3: Reed Hall (BLDG 310)

	Baseline	Poor envelope	Delta
Avg. Temp.	61.6° F	55.7° F	5.9° F
Rate (per hour)	8.68 kWh	9.35 kWh	0.67 kWh
Yearly consumption	76,036.8 kWh	81,906 kWh	5,869.2 kWh
Cost @ \$0.25/kWh	\$19,009.20	\$20,476.50	\$1,467.30

The difference of energy consumption observed between the two conditions saw an increase of 7.7% when the envelope was breached.

C. CASE STUDIES IN LITERATURE

This section of the chapter will portray the results from various studies conducted outside of this case study for comparative analysis. These will all include a holistic approach to reveal energy consumption savings and the various approaches taken to achieve reduced energy goals.

1. NPS Windows and Doors Project

A project has been approved by NPS on four historic buildings on campus to repair deteriorated materials and envelope elements, specifically the windows and doors. The four buildings analyzed for this project were all built in 1952 and collectively consist of 1,485 window units and 44 doors (Naval Facilities Engineering Command Southwest [NAVFAC], 2020). 73.6% window to frame sealant was deteriorated or had ineffective seals and 60% of the frame to wall seals were rated as substandard or inadequate. The proposed course of action is to replace the single pane windows and doors with high efficiency low-e glazing and the associated frames to modern aluminum materials to both reduce the maintenance requirements and increase energy efficiency.

The current energy consumption of the three buildings combined is averaged at 563,600 kWh a year. The improvements are estimated to reduce this average by 16% to bring it down to 473,000 kWh. The total energy savings calculated from this course of

action would save \$12,672 annually on estimated energy savings across all four historic buildings. The cost for this full retrofit project, which includes labor and all hardware, will cost an estimated \$10,770,000 (NAVFAC, 2020). The benefit from replacing all the windows and frames will result in no regular maintenance costs over the remaining life of the building as well as extending the useful life of these buildings with increase aesthetics, thermal efficiencies, and comfort for occupants.

2. Office Building Retrofit in Spain

A project conducted in Spain by Torgal (2017), had the aim to develop a new methodology that will enable cost-effective retrofit projects on existing buildings to optimize energy consumption. The case study retrofit project was conducted under the “Affordable and Adaptable Public Buildings through Energy Efficiency Retrofitting European Project” which aims at implementing affordable technologies to reduce energy consumption by >50%. This study was conducted using simulation software for a building on The Leioa University Campus, which was built around 1970. The retrofits consisted of addressing the building envelope as well as the lighting and HVAC systems, as well as conduct structural repairs and update to the building image (Torgal et al., 2017).

The actions for the retrofit included a list of improvements to the current buildings:

- Installation of vacuum insulation panels on the exterior walls.
- Replacement of some windows with low-e windows.
- Partial replacement of lighting system.
- Various control systems.
- Roof insulation.

The results from this study showcased a reduction in energy consumption around 46% which is broken down in Figure 11 (Torgal et al., 2017).

	Nonretrofitted	Retrofitted
Heating (kWh/m ² -year)	58.7	13.1
Cooling (kWh/m ² -year)	1.3	3.1
Lighting (kWh/m ² -year)	29.3	25.4 ^a
Equipment (kWh/m ² -year)	14.2	14.2
TOTAL (kWh/m²-year)	103.5	55.8

Figure 11. Energy consumption before and after retrofit.
Source: Torgal et al. (2017).

3. Classroom Case Study in Egypt

A case study was done in the hot arid environment of Egypt on multiple classrooms to analyze the effect of improvements to the building's envelope. The purpose of this study was to provide a general overview of various retrofit components and their effects. A simulation model was used to determine effects after collecting base data to use as a benchmark.

The study was conducted by El-Darwish and Gomaa (2017) on buildings with no insulation with only a cooling requirement, single pane windows and no solar shading. The classroom size for case 1 was 680 square meters, case 2 was 1800 square meters, and case 3 was 1230 square meters (El-Darwish & Gomaa, 2017). The results are presented in Figure 12.

The case results were drawn from a simulation program that implemented retrofit measures:

- Window replacement with low-e double glazed windows (4/6/4 mm argon filled).
- air tightness enhancements (43% reduction mitigated near windows and seams).
- external wall insulation (0.05-meter thickness).
- solar shading (0.5-meter metal louvers).

	Double Glazing	Air Tightness	External Wall Insulation	Solar Shading
Case 1	11%	14%	15%	25%
Case 2	5%	7%	8%	23%
Case 3	9%	9%	8%	52%
Average	8%	10%	10%	33%

Figure 12. Retrofit results. Source: El-Darwish and Gomaa (2017).

4. GSA Deep Retrofit Program

The GSA has led extensive retrofits under their National Deep Energy Retrofit (NDER) program to showcase innovative technologies along with renewable energies to push buildings within the government toward the net-zero goal. This project spanned across many states and included 80 buildings which resulted in an average of 38.2% in energy savings over the baseline (Shonder, 2014). Various projects conducted within the NDER program are analyzed in a report which highlights the inclusion of building envelope energy conservation measures published in 2014. The report shows that projects rendered significant energy savings when including envelope improvements and averaged 35% savings as depicted in Table 5 (Shonder, 2014). Many of these projects undertook a holistic approach and included many ECMs to obtain reductions in energy consumption.

Table 5. GSA Deep Energy Retrofit. Adapted from Shonder (2014).

GSA National Deep Energy Retrofit						
Buildings	Location	Conservation Measures	Investment	Term (years)	Energy Savings (MMBtu/yr)	Percent Energy Savings
U.S. Custom House-Ribicoff Federal Building	New Bedford, MA / Hartford, CT	Custom House	\$3,372,681	20	4,330	16%
		Boiler Burner Conversion Lighting Upgrades Roof Replacement and Insulation Upgrade Ribicoff				
Goodfellow Federal Center	Overland MO	Controls Upgrades Lighting Upgrades Building Weatherization Insulate Steam Components Upgrade to LP Steam Header/Install	\$9,121,413	22	38,889	28%
		Controls - Separate Lighting/HVAC AHU Replacement MUA Boiler Initiative IR/Split System - 122B to 110 Track Shed Lighting Building Envelope AHU Sealing AHU VFD Transformers Plumbing Fixtures Ice Machine Kitchen Sprayer				
Silver Spring/New Carrollton	Silver Spring/Lanham MD	New Carrollton	\$44,633,045	22	94,588	60%
		Water Conservation Building Envelope Improvements Exhaust Air to OA Energy Recovery Kitchen Exhaust Controls Electric & Telephone Rm Cooling System Upgrades Silver Spring Lighting Upgrades & Advanced Lighting Controls Chilled Water Improvements Ventilation Air System Optimization Building System Controls Premium Efficiency Motors Water Conservation Building Envelope Improvements High Efficiency Transformers				

V. ANALYSIS AND DISCUSSION

A. PROBLEM STATEMENT

The United States is the second largest consumer of energy in the world and the government is the country's largest consuming industry (EIA, n.d.). The DOD makes up the largest portion of the government's energy use portfolio with nearly 300,000 buildings (Conger, 2018). As the top consumer in the United States and a world leader, the U.S. and the DOD inherently has the responsibility to set the example for energy efficiency standards. Legislation for reduced energy use was passed to reduce the impact of the volatile energy market and this volatility is still experienced today. The DOD needs action plans to systematically mitigate energy waste.

A retrofit plan is necessary due to the fact most of the DOD stock is made up of aged buildings that will likely be a significant portion of the building portfolio in 2045 with a large portion exceeding their life expectancy (GAO, 2022). The executive branch has laid out energy reduction targets that require actionable plans in reducing energy consumption. The problem in reaching those goals is the limited resources evidenced by the chronically underfunded facilities sustainment appropriation which has led to deteriorating facilities with a growing backlog of maintenance (GAO, 2022). With a new funding model being implemented after finding shortcomings within the current model, building condition and age will now play a significant factor in future analysis. This is important in identifying proper funding levels for retrofitting plans within the DOD building stock. This will hopefully set new funding targets that address the older buildings. Following this, identifying cost-effective and readily available methods for reaching these goals are the challenge the DOD faces in a fiscally constrained environment the DOD operates in. As most buildings are aged and beyond their life expectancy, repairs and retrofit projects are necessary to ensure efficient energy use and the longevity of these buildings.

B. ANALYSIS OF NPS CASE STUDY

The multiple case study approach across the three selected buildings highlights the effect a poor envelope has on energy consumption. This case study was limited in the

approach of design by only manipulating one element. The air tightness is only one element within a buildings envelope system, and each carries a different effect on thermal losses. The data suggests that the impact of the air tightness alone can have significant long-term costs if unaddressed. The marginal losses observed can be accrued over the life of a building if unaddressed and can become a significant cost in utilities across multiple buildings on an installation. The purpose of this case analysis is tied to the data from air tightness but should be considered a building block for a full-scale envelope assessment.

When retrofits are being proposed, an analysis of each component should be done on the envelope to reveal the weak points that can render the highest energy savings. The data collected along with the literature reviewed, suggest there should be a holistic approach that includes multiple elements to have an effective retrofit project. The results of this case study provide confirmatory data towards the effect building envelopes have on energy consumption.

Each of the individual case studies showed an increase in energy consumption when the envelope was breached to simulate a poor envelope. A breakdown of each of the buildings case study results is located within Figure 13 for comparison. The degree of effectiveness varied from case to case as expected, but they all showed over a 5% increase in energy consumption when the envelope was breached. However, the effect is largely based on building condition and a similar case study has shown up to 50% of heat transfer can be lost due to air infiltration (Šadauskienė et al., 2014).

	1) Dudley Knox Library	2) ME Lecture Hall	3) Reed Hall
Built	1971	1994	2011
UFC standards (2002)	No	No	Yes
Age	51 years	28 years	11 years
Size	93,070 sqft	2,480 sqft	12,826 sqft
Temp. Variation	3.25° F	0.6° F	5.9° F
Rate Increase	3.47 kWh	0.13 kWh	0.67 kWh
Lost \$ from envelope	\$7,621.20 per year	\$284.70 per year	\$1,472.17 per year
% difference	+5.6%	+5.1%	+7.7%

Figure 13. NPS case study combined results

The date when buildings were built plays a significant role in the data, as buildings that were built prior to UFC implementation in 2002 showed a marginal increase when compared to the building built after the standards for building envelopes within the UFC were introduced. This can be attributed to older and less effective materials making up the remaining elements of the building's envelope, leading to a dampened impact when purposefully breaching the envelope.

Buildings 1 and 2 were built prior to the 2002 implementation of UFC within the DOD, in 1971 and 1994 respectively. The results from these two buildings showed an average of 5.35% increases in energy consumption across the two buildings, which was significantly less than the variation in energy consumption compared to the building built after 2002. Building 3 was built after UFC standards were implemented which was evident by the lack of elements of the envelope available to manipulate and allow air infiltration, such as windows or doors. The construction materials of the envelope elements utilized in building 3 were effective against heat transfer, such as the 8" thick concrete walls with added insulation and double pane windows with solar shades. The variation when allowing air infiltration on building 3 was more dramatic in this case which showed an increase of consumption at 7.7%. Many of the assets in the DOD's building portfolio are made up of older buildings where envelopes might have poor air tightness conditions and qualities as observed in buildings 1 and 2.

Building size was significantly different across the case study which drew comparative results. As the building size increased so did the energy consumption. The average increase in energy consumption rate with manipulation of the envelope was similar across all buildings. Collectively, the buildings saw an average increase of 6.13% of energy consumption which all drew comparatively close differences in consumption rate increases relative to overall consumption for the building. The data signals that the rate of energy lost is not dependent on building size, but overall waste is. This should be considered in cost analysis of retrofit projects.

The temperature in this case study was not a controlled variable and an inference on energy consumption could be made. The temperature variation observed on building 3 was the most drastic of the three case studies at 5.9°F, which was about double the

temperature variation observed in the other two buildings. This could have affected the energy consumption as building 3 also had the most significant change in energy consumption at 7.7%, which was about 2% above the buildings that didn't experience such a drastic difference in observed temperatures during the case study. To expand on the effect of air temperature, a case study should be done over the course of a full year to account for all seasons to signal the full impact of temperature variations and its effect on energy consumption in conjunction with envelope elements.

The air tightness of a building is only one element of the envelope addressed. Although not the most impactful element of the building envelope, this study highlights the fact that it does play a role in the overall envelope system which can be addressed to reduce waste. Finding the targeted building envelope element to address will be determinate on current building conditions and the cost of each energy conservation measure introduced when improving building envelope effectiveness.

C. MULTIPLE CASE STUDY ANALYSIS

When comparing each of the case studies presented in the results section, it is apparent that various techniques are dependent on the building a retrofit project is being conducted on. Each building had a starting condition that warranted a different approach. This is typical and the DOD is subject to this same constraint. The various ECM aimed at the building's envelope achieved a range of energy reduction percentages with the largest effect from these being observed with a combination of elements being addressed. Each retrofit did result in reduction of energy consumption but at varying costs. A holistic approach renders the highest savings in both the actual retrofits and the simulations. The simulations were presented to provide examples of effective means to identifying cost effective retrofit measures to reach targets. Within each of these case studies, it was noted that the retrofit measures increased user comforts by reducing thermal losses and aesthetic appeal along with extending the useful life of the buildings.

When comparing the air tightness element of the building envelope, the NPS case study aligns with the results from the Egypt case study. The NPS average consumption increase was around 6% while the comparative results from Egypt resulted in an average

of 10% of reduced energy from air tightness alone (El-Darwish & Gomaa, 2017). Although a small impact was observed, the retrofit measures for air tightness can be addressed with minimal cost by locating and sealing gaps and seams found in common locations such as window frames and building elements that protrude through the envelope.

D. RECOMMENDATION

To address the goals for energy consumption of buildings, retrofit plans should include ECMs that include improvements to the building envelope. This case reveals data that confirms the effect the envelope plays in energy costs. A minor degradation in the envelope's effectiveness can mean growing sustainment costs which can be mitigated through retrofit projects aimed at capturing the losses seen in utility cost. Most buildings within the DOD portfolio are aged and have exceeded their life expectancy, making retrofit plans a likely endeavor to maintain the use of these buildings. The retrofit approach has benefits two-fold: reducing the cost for utilities for the life of the building and extending the useful life of buildings. Building envelopes are just one of the many aspects of a building retrofit plan to reduce O&M costs and additional savings can be made when coupled with other ECMs. This should be done sequentially to observe the effect of improved envelope energy intensity reductions to ensure HVAC and future alternate energy source capacities are equivalent to building demand.

As evidenced in deep-retrofit projects, this case study and others like it, a significant reduction in energy demand can be achieved when building envelope elements are improved along with other ECMs. A full energy audit beyond the current scope (minimum of 25% a year) should be conducted when the new SMS funding model is implemented to gain an accurate picture of buildings condition to allocate the required funding levels. A myriad of low-cost solutions can yield increased effectiveness of building envelopes and a full cost analysis of the various elements of building envelopes in conjunction with simulation programs should be conducted to ensure cost effectiveness of projects.

THIS PAGE INTENTIONALLY LEFT BLANK

VI. CONCLUSION

As a top consumer of energy in the United States, the DOD is in a unique position to lead by implementing and showcasing effective ways to reduce energy consumption and carbon emissions. A holistic approach is necessary to reach reduction goals and facilitate growth in the energy efficiency and retrofit industry. The challenges the DOD faces are competing priorities for limited financial resources and the lack of an accurate assessment of current infrastructure. The case study's aim is to provide confirming data that improving building envelopes is an approach that can have downstream benefits including reaching goals for the reduction of building energy intensity and highlighting the financial losses that can be accrued when envelopes are ignored.

A. DOWNSTREAM BENEFITS OF BUILDING ENVELOPES

This study identifies four primary downstream benefits acquired from retrofitting the aged DOD stock with a focus on the building's envelope.

- **Reduced energy consumption:** the reduced energy intensity following a retrofit project can lead to long term cost savings and reduced CO₂ emissions to reach goals for net-zero. This also protects the DOD from volatility in the energy market.
- **Follow-on investments:** reduced thermal demand will result in reduced system capacity requirements on HVAC systems. When replacement is needed, a smaller unit can be utilized to reduce costs of both initial investments as well as operational costs. This could lead to accurate energy capacity requirements for microgrid systems on installations.
- **Occupant comfort:** better control of the temperature and system performance could lead to healthier users of the buildings. Improved envelope elements can also increase aesthetic appearance of building which can improve the quality of the working environment.

- Growth of the economy: a significant impact to the national gross domestic product (GDP) can be observed with an influx in retrofit project demand. This will likely lead to expansion within the industry with additional companies entering the market, effectively lower the cost and broadening retrofit project options to more of the population.

From this multiple case study analysis, it is evident that building envelopes play a crucial role in energy consumption. The overall decrease in energy waste across the studies signal that building envelopes can be manipulated to effect consumption rates and weak envelopes should be addressed. This confirms that retrofit projects aimed at addressing the building envelope will reduce waste by decreasing consumption by reducing heat transfer from the controlled environment to the uncontrolled environment. Retrofits will increase the energy efficiency of the building which will lead to cost savings over time.

These categories of benefits provide not only financial incentives but also quality of environment for the DOD workforce. Retrofitting strategies are not only aimed at reducing energy consumption but also life cycle energy and emissions reductions when compared to the destruction and construction of new buildings. With the increased understanding of the impact of climate change on national security, each contributing factor needs to be addressed and mitigated. Overall improvements of the current DOD building stock is necessary to achieve these goals and finding opportunities to reduce non-renewable energy in the strive towards net-zero building emissions by 2045. This transition will take time and efforts should be made on both the reduction of energy consumption and the implementation of renewable energy sources.

B. THE HOLISTIC APPROACH

Considering the results from this case study, envelopes play a significant role in reducing energy consumption of buildings. Envelope retrofits should not be the sole effort of projects but a complementing factor in a holistic approach that includes a multitude of ECMs. When coupled with other ECMs the typically long payback periods for investments in retrofits can be reduced with a significant increase in energy savings over time. Addressing a single element will only have marginal effects and should only be considered

if that element is severely degraded and repairs are needed before a fully developed deep retrofit project can be implemented. The building envelope is a system, and each component has a different average savings, largely depended on the current material or condition, so a holistic analysis and retrofit need be considered to achieve a cost-effective solution.

C. OPPORTUNITIES FOR FURTHER RESEARCH

As retrofits gain in popularity, and the DOD becomes more aware of the true conditions of its building stock, the full myriad of elements within the building envelope system should be tested to prove the potential benefits with specific retrofit projects. With the new funding modeling system being introduced for the DOD, a better understanding of what is required to fund these projects will hopefully contribute more capital towards a retrofit program and analysis on this new system can be dissected to prove effectiveness. Simulation models that estimate effectiveness of retrofit measures should be tested to gauge effectiveness and potential DOD-wide implementation of a standard approach to retrofits could be investigated. An analysis of energy consumption following the NPS Windows and Doors project could be conducted to gauge accuracy of estimates.

This case study was limited in duration and elements under the control; a more in-depth study can be done on these buildings to encompass a longer duration or multiple elements. A project that implements new technologies introduced in this paper can be implemented on a micro scale to gauge effectiveness to promote use within the DOD.

THIS PAGE INTENTIONALLY LEFT BLANK

LIST OF REFERENCES

- Aguilar-Santana, J. L., Jarimi, H., Riffat, S., & Velasco-Carrasco, M. (2020). Review on window-glazing technologies and future prospects. *International Journal of Low-Carbon Technologies*, 15(1), 112–120. <https://doi.org/10.1093/ijlct/ctz032>
- Akander, J., Ameen, A., Gameiro Da Silva, M., Mattsson, M., Moghaddam, S. A., & Simões, N. (2021). Low-emissivity window films as an energy retrofit option for a historical stone building in cold climate. *Energies*, 14(22), 7584. <https://doi.org/10.3390/en14227584>
- Alchapar, N. L., Colli, M. F., & Correa, E. N. (2020). Albedo quantification using remote sensing techniques. Cool roof in the metropolitan area of Mendoza-Argentina. *IOP Conference Series: Earth and Environmental Science*, 503(1), 012035. <https://doi.org/10.1088/1755-1315/503/1/012035>
- Aldykiewicz Jr, A., Desjarlais, A. O., Hun, D. E., & Salonvaara, M. (2020). *Cost assessment of building envelope retrofits*. Oak Ridge national lab. (ORNL), Oak Ridge, TN (United States). <https://www.osti.gov/biblio/1651335>
- Allacker, K., Bosmans, M., Mirabella, N., Passer, A., Röck, M., Ruschi Mendes SAADE, & M., Spirinckx, C. (2018). Strategies to improve the energy performance of buildings: a review of their life cycle impact. *Buildings*, 8(8), 105. <https://doi.org/10.3390/buildings8080105>
- Altan, H., & Mohelníková, J. (2009). *Evaluation of optical and thermal properties of window glazing*. 5(1), 8. <http://www.wseas.us/e-library/transactions/environment/2009/31-277.pdf>
- Amirkhani, S., Bahadori-Jahromi, A., Cook, D., Godfrey, P., & Mylona, A., (2019). Impact of low-e window films on energy consumption and CO2 emissions of an existing UK hotel building. *Sustainability*, 11(16), 4265. <https://doi.org/10.3390/su11164265>
- Ardente, F., Beccali, M., Cellura, M., & Mistretta, M. (2011). Energy and environmental benefits in public buildings as a result of retrofit actions. *Renewable and Sustainable Energy Reviews*, 15(1). <https://doi.org/10.1016/j.rser.2010.09.022>
- Armstrong, M., Arsenault, C., Galasiu, A., Laouadi, A., Marchand, R. G., Swinton, M. C., & Szadkowski, F. (2008). Field performance of exterior solar shadings for residential windows: Winter results. *Proceedings the 5th IBPSA Canada Conference*. https://www.researchgate.net/profile/Anca-Galasiu/publication/44093051_Field_performance_of_exterior_solar_shadings_for_residential_windows_Winter_results/links/0912f51473b45c4e3c000000/Field-performance-of-exterior-solar-shadings-for-residential-windows-Winter-results.pdf

- Banionis, K., Paukštys, V., Šadauskienė, J., & Seduikyte, L. (2014). Impact of air tightness on the evaluation of building energy performance in Lithuania. *Energies*, 7, 4972–4987. <https://doi.org/10.3390/en7084972>
- Bianco, N., Granqvist, C.-G., Jelle, B. P., Kurnitski, J., Torgal, F. P., & Vanoli, G. P. (2017). *Cost-effective energy-efficient building retrofitting: Materials, technologies, optimization and case studies*. <https://www.gbv.de/dms/tib-ub-hannover/87813025x.pdf>
- Bozlar, M., Guo, H., Liu, Z., Luo, Y., Meggers, F., & Zhang, L. (2019). Active building envelope systems toward renewable and sustainable energy. *Renewable and Sustainable Energy Reviews*, 104, 470–491. <https://doi.org/10.1016/j.rser.2019.01.005>
- Cao, Y., Gao, Y., Hou, C., Huang, Y., Meng, X., Shen, Q. & Zhang, L. (2018). Optimization of the wall thermal insulation characteristics based on the intermittent heating operation. *Case studies in construction materials*. <https://doi.org/10.1016/j.cscm.2018.e00188>
- Casini, M. (2016). *Smart buildings: Advanced materials and nanotechnology to improve energy-efficiency and environmental performance*. Elsevier: Woodhead Pub Ltd.
- Celniker, C., Chen, S., Levinson, R., & Meier, A. (2021). Targeting buildings for energy-saving cool-wall retrofits: A case study at the University of California, Davis. *Energy and Buildings*, 249, 111014. <https://doi.org/10.1016/j.enbuild.2021.111014>
- Conger, J. (2018). An overview of the DOD installations enterprise. *The Heritage Foundation*. <https://www.heritage.org/military-strength-topical-essays/2019-essays/overview-the-dod-installations-enterprise>
- Congressional Research Service (2018). *Energy savings performance contracts (ESPCs) and utility energy service contracts (UESCs)* (CRS Report No. R45411). Congressional Research Service. https://www.everycrsreport.com/files/20181123_R45411_ec0679adccd2a846875df0afbd5ce837f19b32d7.pdf
- Dascalaki, E., Flourentzou, F., Koronaki, I., Labben, H. H., Richalet, V., Roulet, C.-A., & Santamouris, M. (2002). ORME: A multicriteria rating methodology for buildings. *Building and Environment*, 37(6), 579–586. [https://doi.org/10.1016/S0360-1323\(02\)00005-7](https://doi.org/10.1016/S0360-1323(02)00005-7)
- Department of Defense. (2007, June). *Facilities sustainment, restoration and modernization* (DOD 7000.14-R). https://comptroller.defense.gov/Portals/45/documents/fmr/archive/02barch/02b_08old.pdf

- Department of Defense. (2009, December 11). *Installation energy management* [DoDI 4170.11]. Department of Defense. <https://www.esd.whs.mil/Portals/54/Documents/DD/issuances/dodi/417011p.pdf?ver=2019-04-15-094505-563>
- Department of Defense. (2014, March 1). *Unified facilities criteria (UFC)* (UFC 1–200-02). https://www.acq.osd.mil/eie/Downloads/IE/UFC_1_200_02.pdf
- Department of Defense. (2019, October). *Financial management regulation* (DOD 7000.14-R). https://comptroller.defense.gov/Portals/45/documents/fmr/current/12/12_12.pdf
- Department of Energy. (n.d.a.). *ARPA-E announces \$30 million in funding for window efficiency technologies*. <https://www.energy.gov/articles/arpa-e-announces-30-million-funding-window-efficiency-technologies>
- Department of Energy (n.d.b). *Meet DOE's newest advanced building construction (ABC) projects*. Energy.Gov. <https://www.energy.gov/eere/buildings/articles/meet-does-newest-advanced-building-construction-abc-projects>
- Department of Energy. (2004). *HVAC improvements for existing homes*. <https://www.osti.gov/servlets/purl/824856>
- Department of Energy. (2012). *Case study: group home energy efficiency retrofit for 30% energy savings*. Department of Energy, Energy Efficiency & Renewable Energy. http://www.ba-pirc.org/casestud/pdf/SashaBruce_CaseStudy.pdf
- Department of Energy. (2015). *Increasing efficiency of building systems and technologies*. Department of Energy. <https://www.energy.gov/sites/prod/files/2017/03/f34/qtr-2015-chapter5.pdf>
- Department of Energy. (2019, March 4). *Anisotropic thermal management for building envelopes*. <https://www.energy.gov/eere/buildings/articles/anisotropic-thermal-management-building-envelopes>
- Department of Energy. (2020, July 13). *Transformative building envelope retrofit using insulation-inflatable walls assisted by automation*. <https://www.energy.gov/eere/buildings/articles/transformative-building-envelope-retrofit-using-insulation-inflatable-walls>
- Department of Energy. (2022, February 14). *U.S. Department of Energy announces \$175 million for novel clean energy technology projects*. <https://arpa-e.energy.gov/news-and-media/press-releases/us-department-energy-announces-175-million-novel-clean-energy>
- Douglas P., & Chafetz, M. (2020, August 3). *Overcladding strategies for institutional buildings*. <https://www.buildingenclosureonline.com/articles/89161-overcladding-strategies-for-institutional-buildings>

- El-Darwish, I., & Gomaa, M. (2017). Retrofitting strategy for building envelopes to achieve energy efficiency. *Alexandria engineering journal*, 56(4). <https://doi.org/10.1016/j.aej.2017.05.011>
- Energy Management Requirements, 42 U.S.C. § 8253 (2010). <https://www.govinfo.gov/app/details/USCODE-2010-title42/https%3A%2F%2Fwww.govinfo.gov%2Fapp%2Fdetails%2FUSCODE-2010-title42%2FUSCODE-2010-title42-chap91-subchapIII-partB-sec8253>
- Energy Policy Act of 2005, H.R.6, 109th Cong. (2005). <https://www.congress.gov/bill/109th-congress/house-bill/6>
- Energy Star. (n.d.). *Benchmark your building using ENERGY STAR® portfolio manager®*. <https://www.energystar.gov/buildings/benchmark>
- Exec. Order NO. 14008 (2021). <https://www.regulations.gov/document/EPA-HQ-OPPT-2021-0202-0012>
- Exec. Order NO. 14057 (2021). <https://www.federalregister.gov/documents/2021/12/13/2021-27114/catalyzing-clean-energy-industries-and-jobs-through-federal-sustainability>
- Feng, G., Sha, S., & Xu, X. (2016). Analysis of the building envelope influence to building energy consumption in the cold regions. *Procedia Engineering*, 146. <https://doi.org/10.1016/j.proeng.2016.06.382>
- Government Accountability Office. (2016). *Defense infrastructure: Energy conservation investment program needs improved reporting, measurement, and guidance*. (GAO-16-162; p. 50). <https://www.gao.gov/products/gao-16-162>
- Government Accountability Office (2022). *Defense infrastructure: DOD should better manage risks posed by deferred facility maintenance* (GAO-22-104481). <https://www.gao.gov/products/gao-22-104481>
- Greenley, H. L. (2019). *Department of Defense energy management: Background and issues for Congress* (CRS Report No. R45832). Congressional Research Service. <https://sgp.fas.org/crs/natsec/R45832.pdf>
- Hanafy, A. A., Soutullo, S., Suárez-López, M. J., & William, M. A. (2021). Building envelopes toward energy-efficient buildings: A balanced multi-approach decision making. *International journal of energy research*, 45(15), 21096–21113. <https://doi.org/10.1002/er.7166>
- International—U.S. Energy Information Administration (n.d.). <https://www.eia.gov/international/rankings/world?pa=12&u=0&f=A&v=none&y=01%2F01%2F2019>

- Inspector General. (2017). *Naval facilities engineering command southwest and marine corps base camp Pendleton officials' use of utility energy services contracts* (Report No. DODIG-2017-125). Department of Defense. <https://media.defense.gov/2017/Oct/10/2001824957/-1/-1/1/DODIG-2017-125.PDF>
- Jarad Serbu. (2018, April 3). Congress gives DOD big boost for facility upkeep, but not enough to fix deteriorating buildings. *Federal News Network*. <https://federalnewsnetwork.com/dod-reporters-notebook-jared-serbu/2018/04/congress-gives-dod-big-boost-for-facility-upkeep-but-not-nearly-enough-to-fix-deteriorating-buildings/>
- National Energy Act, H.R.8444, 95th Cong. (1977). <https://www.congress.gov/bill/95th-congress/house-bill/8444>
- National Energy Conservation Policy Act, H.R. 5037, 95th Cong. (1978). <https://www.congress.gov/bill/95th-congress/house-bill/5037>
- Naval Facilities Engineering Command Southwest. (2020). *NPS window and door eval June 2020* (Study). Department of Defense.
- Nguyen, F. (2021, June 4). *Guam won't give up more land to the U.S. military without a fight*. Prism. <http://prismreports.org/2021/06/04/guam-wont-give-up-more-land-to-the-u-s-military-without-a-fight/>
- Niro, T. (2017). *Utility energy service contracts: Enabling documents*. Department of Energy. https://www.energy.gov/sites/prod/files/2019/01/f58/uesc_enabling_documents_jan_19.pdf
- Office of Budget. (2022). *Highlights of the Department of the Navy FY 2023 Budget* [Budget Highlight]. Department of the Navy. https://www.secnav.navy.mil/fmc/fmb/Documents/23pres/Highlights_Book.pdf
- Office of the Under Secretary of Defense (Comptroller). (2022). *Meeting the climate challenge, Department of Defense budget FY 2023*. Department of Defense. https://comptroller.defense.gov/Portals/45/Documents/defbudget/FY2023/FY2023_Meeting_the_Climate_Challenge_J-book.pdf
- Rebecca George. (2015, February 5). *Defense department energy use falls to lowest level since at least 1975*. <https://www.eia.gov/todayinenergy/detail.php?id=19871>
- Regenthal, S., & Tetreault, T. (2011). *ESPC overview: Cash flows, scenarios, and associated diagrams for energy savings performance contracts* (NREL/TP-7A30-51398). National renewable energy laboratory. <https://www.nrel.gov/docs/fy11osti/51398.pdf>

- Shonder, J. (2014). *Energy savings from GSA's national deep energy retrofit program*. Department of Energy. <https://www.gsa.gov/cdnstatic/NDEREnergySavingsReport5.pdf>
- Wallechinsky, D. (2016). *AllGov—Departments*. <http://www.allgov.com/departments/departments-of-energy?detailsDepartmentID=565>
- The White House. (2021, March). *Interim national security strategic guidance*. <https://www.whitehouse.gov/wp-content/uploads/2021/03/NSC-1v2.pdf>
- The White House (2022, June 1). *FACT SHEET: Biden-Harris administration launches initiative to modernize building codes, improve climate resilience, and reduce energy costs*. <https://www.whitehouse.gov/briefing-room/statements-releases/2022/06/01/fact-sheet-biden-harris-administration-launches-initiative-to-modernize-building-codes-improve-climate-resilience-and-reduce-energy-costs/>
- The White House (2021, December 8). *FACT SHEET: President Biden signs executive order catalyzing America's clean energy economy through federal sustainability*. <https://www.whitehouse.gov/briefing-room/statements-releases/2021/12/08/fact-sheet-president-biden-signs-executive-order-catalyzing-americas-clean-energy-economy-through-federal-sustainability/>
- Yin, R. K. (2009). *Case study research: Design and methods*. SAGE.

INITIAL DISTRIBUTION LIST

1. Defense Technical Information Center
Ft. Belvoir, Virginia
2. Dudley Knox Library
Naval Postgraduate School
Monterey, California