



**Calhoun: The NPS Institutional Archive**  
**DSpace Repository**

---

Theses and Dissertations

1. Thesis and Dissertation Collection, all items

---

2001-09

The use of knowledge based decision support systems in reengineering selected processes in the U.S. Marine Corps

Korzilius, Holly N.

---

<http://hdl.handle.net/10945/9740>

*Downloaded from NPS Archive: Calhoun*



Calhoun is a project of the Dudley Knox Library at NPS, furthering the precepts and goals of open government and government transparency. All information contained herein has been approved for release by the NPS Public Affairs Officer.

**Dudley Knox Library / Naval Postgraduate School**  
**411 Dyer Road / 1 University Circle**  
**Monterey, California USA 93943**

<http://www.nps.edu/library>

**NAVAL POSTGRADUATE SCHOOL  
Monterey, California**



**THESIS**

**THE USE OF KNOWLEDGE BASED DECISION SUPPORT  
SYSTEMS IN REENGINEERING SELECTED PROCESSES  
IN THE U. S. MARINE CORPS**

by

Holly N. Korzilius

September 2001

Thesis Advisor:  
Associate Advisor:

Mark E. Nissen  
Erik Jansen

**Approved for public release; distribution is unlimited.**

# REPORT DOCUMENTATION PAGE

Form Approved OMB No.  
0704-0188

Public reporting burden for this collection of information is estimated to average 1 hour per response, including the time for reviewing instruction, searching existing data sources, gathering and maintaining the data needed, and completing and reviewing the collection of information. Send comments regarding this burden estimate or any other aspect of this collection of information, including suggestions for reducing this burden, to Washington headquarters Services, Directorate for Information Operations and Reports, 1215 Jefferson Davis Highway, Suite 1204, Arlington, VA 22202-4302, and to the Office of Management and Budget, Paperwork Reduction Project (0704-0188) Washington DC 20503.

<b>1. AGENCY USE ONLY (Leave blank)</b>		<b>2. REPORT DATE</b> September 2001	<b>3. REPORT TYPE AND DATES COVERED</b> Master's Thesis	
<b>4. TITLE AND SUBTITLE</b> The Use of Knowledge Based Decision Support Systems in Reengineering Selected Processes in the U.S. Marine Corps			<b>5. FUNDING NUMBERS</b>	
<b>6. AUTHOR (S)</b> Holly Noel Korzilius				
<b>7. PERFORMING ORGANIZATION NAME(S) AND ADDRESS(ES)</b> Naval Postgraduate School Monterey, CA 93943-5000			<b>8. PERFORMING ORGANIZATION REPORT NUMBER</b>	
<b>9. SPONSORING / MONITORING AGENCY NAME(S) AND ADDRESS(ES)</b>			<b>10. SPONSORING/MONITORING AGENCY REPORT NUMBER</b>	
<b>11. SUPPLEMENTARY NOTES</b> The views expressed in this thesis are those of the author and do not reflect the official policy or position of the U.S. Department of Defense or the U.S. Government.				
<b>12a. DISTRIBUTION / AVAILABILITY STATEMENT</b> Approved for public release; distribution unlimited			<b>12b. DISTRIBUTION CODE</b>	
<b>13. ABSTRACT (maximum 200 words)</b> →In light of the continued investment in information technology by businesses in hopes of achieving a measurable benefit in terms of process efficiency and effectiveness, business process reengineering (BPR) is becoming increasingly important. BPR suggests that by radically redesigning underlying business processes, companies can achieve breakthrough improvements in productivity. BPR, however, is a knowledge intensive endeavor. A decision support tool called KOPeR-lite was developed with the intent of encoding the knowledge held by BPR experts and documented in BPR literature. This tool promises to assist BPR novices who are tasked with reengineering inefficient or ineffective processes. The purpose of this thesis is to determine the viability of using KOPeR-lite when BPR novices undertake process reengineering projects. It also proposes reengineering solutions for the permanent change of station orders process for USMC officers, which will be presented to the leadership in the Headquarter, U.S. Marine Corps (HQMC) Manpower and Reserve Affairs (M&RA) branch. If adopted, one of the proposed solutions promises to dramatically improve process performance				
<b>14. SUBJECT TERMS</b> Process reengineering, BPR, knowledge-based systems, expert systems			<b>15. NUMBER OF PAGES</b> 120	
<b>17. SECURITY CLASSIFICATION OF REPORT</b> Unclassified			<b>16. PRICE CODE</b> UL	
<b>18. SECURITY CLASSIFICATION OF THIS PAGE</b> Unclassified		<b>19. SECURITY CLASSIFICATION OF ABSTRACT</b> Unclassified		<b>20. LIMITATION OF ABSTRACT</b> UL

NSN 7540-01-280-5500

Standard Form 298 (Rev. 2-89)  
Prescribed by ANSI Std. Z39-18

THIS PAGE INTENTIONALLY LEFT BLANK

Approved for public release; distribution is unlimited

**THE USE OF KNOWLEDGE BASED DECISION SUPPORT SYSTEMS IN  
REENGINEERING SELECTED PROCESSES IN THE U. S. MARINE CORPS**

Holly N. Korzilius  
Captain, United States Marine Corps  
B.M.A., University of Michigan, 1994

Submitted in partial fulfillment of the  
requirements for the degree of

**MASTER OF SCIENCE IN INFORMATION TECHNOLOGY MANAGEMENT**

from the

**NAVAL POSTGRADUATE SCHOOL  
September 2001**

Author:

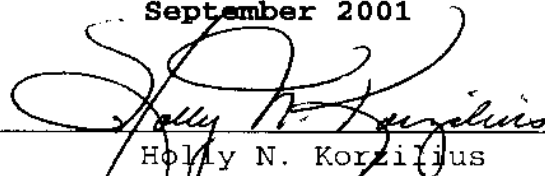
  
Holly N. Korzilius

Approved by:

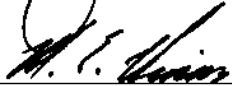
  
Mark E. Nissen, Thesis Advisor

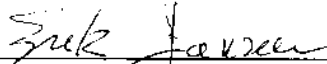
  
Erik Jansen, Associate Advisor

  
Dan C. Boger, Chairman  
Information Systems Academic Group



## **ABSTRACT**

In light of the continued investment in information technology by businesses in hopes of achieving a measurable benefit in terms of process efficiency and effectiveness, business process reengineering (BPR) is becoming increasingly important. BPR suggests that by radically redesigning underlying business processes, companies can achieve breakthrough improvements in productivity. BPR, however, is a knowledge intensive endeavor. A decision support tool called KOPeR-lite was developed with the intent of encoding the knowledge held by BPR experts and documented in BPR literature. This tool promises to assist BPR novices who are tasked with reengineering inefficient or ineffective processes. The purpose of this thesis is to determine the viability of using KOPeR-lite when BPR novices undertake process reengineering projects. It also proposes reengineering solutions for the permanent change of station orders process for USMC officers, which will be presented to the leadership in the Headquarter, U.S. Marine Corps (HQMC) Manpower and Reserve Affairs (M&RA) branch. If adopted, one of the proposed solutions promises to dramatically improve process performance.

THIS PAGE INTENTIONALLY LEFT BLANK



## TABLE OF CONTENTS

I.	INTRODUCTION .....	1
A.	BACKGROUND .....	1
B.	OBJECTIVES .....	2
C.	RESEARCH QUESTIONS .....	2
D.	SCOPE OF THESIS .....	3
E.	RESEARCH METHODOLOGY .....	3
F.	ORGANIZATION .....	5
II.	PROCESS REENGINEERING .....	7
A.	HISTORICAL BASIS .....	7
B.	WHY REENGINEER .....	7
C.	DAVENPORT FRAMEWORK .....	8
1.	Identifying Processes for Innovation .....	9
2.	Identifying Change Levers .....	11
3.	Developing Process Visions .....	11
4.	Understanding Existing Processes .....	12
5.	Designing and Prototyping the New Process .....	12
D.	KOPER-LITE .....	13
E.	HOW MIGHT THE MILITARY BENEFIT FROM PROCESS REENGINEERING EFFORTS .....	16
G.	SUMMARY .....	19
III.	BUSINESS PROCESS REENGINEERING EXPERIMENT .....	21
A.	EXPERIMENTAL DESIGN .....	21
1.	Number of Redesigns Generated .....	22
2.	Delinearization .....	22
3.	Enablers .....	23
4.	Change in the Number of Activities .....	24
5.	Change in the Number of Feedback Loops .....	24
6.	Change in the Number of Handoffs .....	24
7.	Clarity of the Redesign .....	25
8.	Impact .....	26
B.	ASSESSMENT PROCEDURE .....	26
C.	EXPERIMENTAL RESULTS .....	27
1.	Interjudge Reliability .....	27
a.	<i>Delinearization</i> .....	27
b.	<i>IT Enablers</i> .....	28
c.	<i>Non-IT Enablers</i> .....	28
d.	<i>Non-value Added Activities Removed</i> .....	28
e.	<i>Change in Number of Hand-offs</i> .....	29
f.	<i>Clarity</i> .....	29
g.	<i>Impact</i> .....	29
2.	Integrated Analysis .....	29

D.	FINDINGS .....	33
E.	SUMMARY .....	35
IV.	THE PERSONNEL ASSIGNMENT PROCESS IN THE USMC .....	39
A.	DESCRIPTION OF THE CURRENT PROCESS .....	39
B.	PROPOSED REDESIGN ALTERNATIVES .....	49
1.	Redesign Alternative #1 .....	49
2.	Redesign Alternative #2 .....	51
V.	SUMMARY, CONCLUSIONS, AND FUTURE RESEARCH .....	55
A.	SUMMARY .....	55
B.	CONCLUSIONS .....	56
C.	RECOMMENDATIONS .....	56
D.	FUTURE RESEARCH .....	57
APPENDIX A.	DR. MARK'S SOFTWARE DEVELOPMENT CASE .....	59
A.	BASELINE PROCESS .....	59
B.	PROCESS MODEL .....	62
APPENDIX B.	EXPERIMENTAL CASE DATA .....	65
A.	WITHOUT KOPER-LITE .....	65
B.	WITH KOPER-LITE .....	78
APPENDIX C.	KOPER PATHOLOGY DIAGNOSIS AND REDESIGN ADVICE; PCS ORDERS PROCESS FOR USMC OFFICERS .....	89
A.	BASELINE PROCESS .....	89
1.	Diagnosis .....	89
2.	Recommendations .....	89
B.	REDESIGN ALTERNATIVE #1 .....	90
1.	Diagnosis .....	90
2.	Recommendations .....	90
C.	REDESIGN ALTERNATIVE #2 .....	91
1.	Diagnosis .....	91
2.	Recommendations .....	91
APPENDIX D.	EXPLANATIONS OF KOPER REDESIGN RECOMMENDATIONS .....	93
A.	DE-LINEARIZE .....	93
B.	CASE MANAGER .....	93
C.	EMPOWERMENT .....	93
D.	IT SUPPORT .....	94
E.	IT COMMUNICATION .....	94
F.	IT AUTOMATION .....	94
G.	JOINT REVIEWS .....	95
H.	SEQUENTIAL INDEPENDENCE .....	95
I.	EXPERTISE .....	95
J.	TRAINING AND INCENTIVES .....	96
K.	IT TRAINING AND MAINTENANCE .....	97
L.	AUTOMATION AND ELECTRONIC COMMERCE .....	98
M.	IT INFRASTRUCTURE .....	98

N.	SCHEDULING .....	99
O.	WORKFLOW .....	99
	LIST OF REFERENCES .....	101
	INITIAL DISTRIBUTION LIST .....	103

.

THIS PAGE INTENTIONALLY LEFT BLANK

## LIST OF FIGURES

Figure 2-1.	A High-Level Approach to Process Innovation (From Davenport, 1993, pg 200) .....	8
Figure 2-2.	Baseline Process Activity Flow for the Software Development Case Contained in Appendix A .....	10
Figure 3-1.	Redesign Example Highlighting a Reduction in the Number of Handoffs .....	25
Figure 3-2.	Typical Baseline Analysis for the Software Development Case (see Appendix A) .....	31
Figure 4-1.	Baseline Orders Process for USMC Officers ....	48
Figure 4-3.	Alternative #2 Modified PCS Orders Process ...	53

THIS PAGE INTENTIONALLY LEFT BLANK

## LIST OF TABLES

Table 2-1.	Example Process Measure (From Nissen, 2000) ..	14
Table 2-2.	Pathologies and Pathology Samples (Nissen, 2000) .....	15
Table 2-3.	Taxonomy of Redesign Transformations (From Nissen, 2000) .....	15
Table 3-1.	Correlation Matrix. ....	30
Table 3-2a.	Comparison of Means for the "With Outlier" Groups. ....	32
Table 3-2b.	Comparison of Means for the "Without Outlier" Groups .....	32

THIS PAGE INTENTIONALLY LEFT BLANK



## ACKNOWLEDGEMENTS

I would like to thank to following people for their contributions to this thesis:

- Professor Mark E. Nissen for his patience and guidance as I worked to complete this thesis.
- Professor Erik Jansen for his invaluable assistance in the mathematical analysis of the experimental dataset and the confidence he had in me.
- LtCol David A. Mahoney (USMC retired) and CWO3 Eugene Baune (USMC) for taking the time to work with me as I sought to document the baseline permanent change of station orders process for Marine Corps officers.
- My parents for all their support and encouragement.

THIS PAGE INTENTIONALLY LEFT BLANK

## I. INTRODUCTION

### A. BACKGROUND

We often hear the phrase, "work smarter, not harder." However, when working outside our personal areas of expertise, this often can become a challenge because we lack the resources, knowledge, or human resources to aide us. By developing and using expert systems, we can attempt to mitigate this problem.

Expert systems are computerized, advisory programs that attempt to imitate the reasoning processes and knowledge of experts in solving specific problems. The developers of expert systems attempt to capture the knowledge held by human experts by distilling their thought processes and analytical techniques into a series of rules or heuristics applicable within a specified domain. These rules and heuristics are then codified in a form that a computer can use to analyze a problem. Once the expert system is developed, a user can input information pertaining to a problem within the domain for which the expert system was designed. The system then will generate proposed solutions based on its rule/heuristic knowledge base.

Though a situation or process may be novel to us and we may be content to maintain the status quo, experts may have analyzed a similar situation and developed a more effective process. Why not tap into this expertise and take a closer look at the processes we're involved in on a daily basis? We thus ask, "Is there a better way of doing this?" Expert systems may well help us answer this question

more effectively than could a novice working alone, and it is hypothesized that these solutions may be equal in number and viability (if not better) and will be generated in less time than it would take a novice working alone.

## **B. OBJECTIVES**

The purpose of this thesis is to determine the viability of using automated tools, such as KOPeR-lite, when undertaking process reengineering projects. It also proposes reengineering solutions for the USMC Personnel Assignment Process, which will be presented to the leadership in the Headquarter, U.S. Marine Corps (HQMC) Manpower and Reserve Affairs (M&RA) branch. One of the proposed solutions may dramatically improve process performance.

## **C. RESEARCH QUESTIONS**

The central theme of this thesis is process reengineering, in particular the efficiency gains, process flow improvements and decreased redundancy, that may be realized through automation and other enablers of dramatic change. Currently, the process of developing reengineering solutions is largely done using manual techniques that demand extensive knowledge and expertise. To this end, the primary research question is: How can automated tools such as KOPeR-Lite enable reengineering novices to develop good, viable reengineering solutions? Secondary questions include:

- What is reengineering, and what computer based tools are currently available for process-redesign automation and support?
- How does KOPeR-lite function, and what evidence exists concerning its redesign effectiveness?
- Which important U.S. Marine Corps processes offer good potential for reengineering?
- How can KOPeR-lite be employed to redesign important processes in the U.S. Marine Corps?
- How can the results of this study be generalized to other organizations and processes?

#### **D. SCOPE OF THESIS**

The scope includes review of materials on knowledge-based systems, decision support systems, and process reengineering. An analysis of experimental data are then performed to assess the effectiveness of KOPeR-lite. Finally, it draws from the results of this analysis to apply these and other applicable techniques in reengineering the processed followed in making USMC Personnel Assignment decisions.

#### **E. RESEARCH METHODOLOGY**

The methodology used in this thesis research consists of reviewing data from:

- Existing material (i.e. books, professional journals, the web, etc);
- Data generated by students tasked with reengineering software engineering processes; and
- Information from HQMC and 1st Force Service Support Group (FSSG) on the existing process for personnel assignments, to include: Marine Corps directives pertaining to the personnel assignment process as well as information gathered via personal interviews.

The research method also includes process analysis using the Davenport framework and using results from analysis of experimental data associated with KOPeR-lite to redesign the U.S. Marine Corps Personnel Assignment process. Analysis of experimental data is accomplished through the method of content analysis, and analyses of at least two researchers are integrated for reliability. Reengineering is accomplished through a combination of Davenport's five-step process: (1) Identifying Processes for Innovation; (2) Identifying Change Levers; (3) Developing Change Levers; (4) Understanding Existing Processes; and (5) Designing and Prototyping New Processes (including use of KOPeR-lite).

The data obtained are then used to make recommendations to usefulness of KOPeR-lite in process reengineering and propose a reengineered solution to the current personnel assignment process.

In order to analyze and develop a reengineering solution to the current U.S. Marine Corps Personnel Assignment process, data are gathered on the baseline process by reviewing pertinent orders and directives which outline current processes as well as by interviewing manpower personnel at a Major Subordinate Command, specifically 1<sup>st</sup> Force Service Support Group (FSSG) aboard Marine Corps Base Camp Pendleton. Once this is done, attributes of the baseline process are delineated and employed for KOPeR-lite analysis and process pathology identification. Based on KOPeR-lite's proposed transformations, one or more redesigns are developed and included. Following this, the redesign is provided to the

Assistant Chief of Staff, G-1, 1<sup>st</sup> FSSG for review and comment.

## **F. ORGANIZATION**

This thesis is organized as follows. Following this introduction, Chapter II provides a brief historical outline of process reengineering and why it is pursued. Additionally, the Davenport framework is presented along with a functional description of KOPeR-lite. KOPeR-lite is used to depict processes and gain an understanding for redesign. Chapter III covers the experimental design, data, analysis, results and implications. Chapter IV addresses the matter of reengineering the permanent change of station (PCS) orders process for USMC officers. Chapter V summarizes the results of research and study as well as makes recommendations for process improvement and areas for future research.

THIS PAGE INTENTIONALLY LEFT BLANK



## II. PROCESS REENGINEERING

### A. HISTORICAL BASIS

The assembly line, the cotton gin, the type setting machine, and the typewriter: these are all examples of concepts or inventions which led to quantum leap improvements, such as increased productivity, reduced costs, and reduced labor. Each time an invention or new concept is developed, underlying processes in the domain in which it is to be implemented must be evaluated for radical change so that the full potential of the invention or new concept may be realized. Business process reengineering (BPR) suggests that by radically redesigning their business processes, companies can achieve breakthrough improvements in productivity.

### B. WHY REENGINEER

Today, some of the catalysts for change include increased competition, both domestic and foreign, greater availability of information to customers about competing products, a shift from manufacturing to service industries, and the advent of new technologies. The latter has become arguably the biggest driver for change over the past decade. Companies both large and small have made large capital investments in technology only to realize little if any quantifiable improvements in productivity.

One cannot invest in technology and then simply cross one's fingers and hope for the best. A plan must be formulated to ensure underlying business processes are adapted to make full use of the capabilities afforded by

technology. This includes analyzing process workflow, removing non-value added steps, reducing process friction, reducing the number of independent reviews or burdensome oversight functions, increasing information flow (and getting the right information to the right people), and providing training, among other things.

Given the ever-increasing pace of change in the business environment, the question asked by businesses should no longer be "do we need to change?" Rather, businesses need to ask "How can we best change, not only to maintain relevance in the changing environment, but to realize order of magnitude improvement to develop or maintain our competitive advantage?"

### C. DAVENPORT FRAMEWORK

Davenport (Davenport, 1993) advocates a five-step process in the conduct of BPR, as depicted in Figure 2-1.

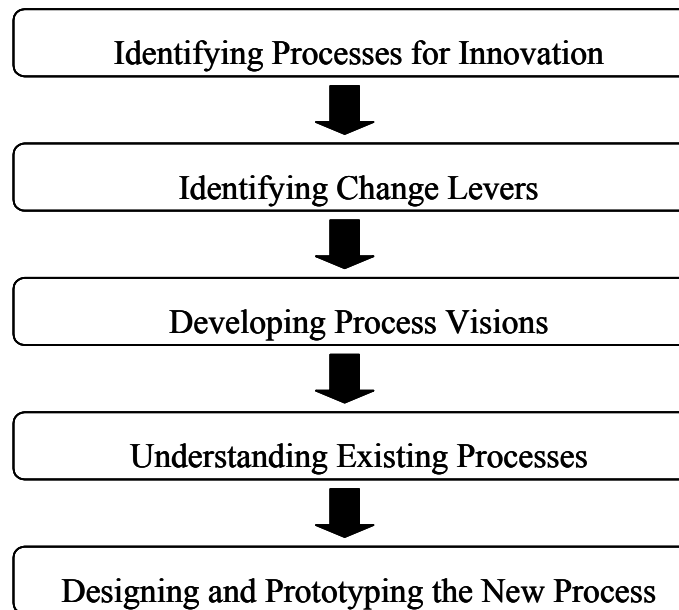

Figure 2-1. A High-Level Approach to Process Innovation (From Davenport, 1993, pg 200)

Before setting a course for change, either incremental or radical, a company must first develop a clear understanding of its current state of affairs. By following the methodology he outlines, an organization will gain a thorough understanding of its existing processes, determine what needs to be accomplished in order to facilitate change, develop redesigns for pathological processes, as well as develop a plan for implementing the change. A clear understanding of existing processes, identification of associated pathologies, and a decision as to whether or not change is needed are of critical importance to this methodology.

#### **1. Identifying Processes for Innovation**

For our purposes, a process is defined as any collection of activities that yield some output of value. This output could be an input to follow-on processes or perhaps some good or service. The case study contained in Appendix A, for example, shows the baseline software development process comprises six fundamental activities: sales, requirements development, design, code, test, and independent test and evaluation (IV&V). In this particular process, each activity follows the one before in a simple linear manner (See Figure 2-2 above).

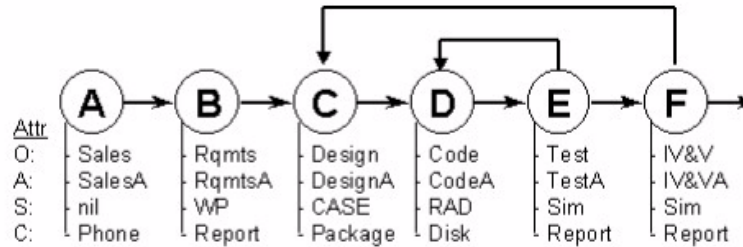

Figure 2-2. Baseline Process Activity Flow for the Software Development Case Contained in Appendix A

Davenport proposes four criteria to aide in selecting processes for innovation:

- (1) the process's centrality to the execution of the firm's business strategy,
- (2) process health,
- (3) process qualification, and
- (4) manageable project scope. The goal of process innovation is order of magnitude improvement in the effectiveness or efficiency.

Unlike incremental change, which is typically a continuous evolution, process innovation should be a discrete, focused effort. By selecting a process that is closely related to the overall business strategy (e.g. the software development process for a company that creates software solutions for its clients), the effects of the change will be felt more profoundly than would likely be the case if a non-core process is chosen for a innovation initiative.

With regard to process health, the more pathologies exhibited by the selected process, the greater the potential gains one may realize by reengineering it.

With regard to process qualification, culture of political climate must be such that innovation efforts will be well received. Also, a committed sponsor of the innovation efforts must be present if there is to be any hope for success. Last, Davenport advises that the project's scope be well defined to provide focus to the innovation process.

## **2. Identifying Change Levers**

The application of information technology (IT) as a change lever is one of Davenport's foci, in part because of the increasing incorporation of and reliance on IT tools in the day-to-day activities of most businesses. Another reason for this focus is that most businesses have failed to realize the full potential of their IT investment. Other change levers include training, workflow redesign, employee empowerment, and changes in organizational design. By using a combination of these tools, business may more fully realize the benefits afforded by IT.

## **3. Developing Process Visions**

"Common sense tells us that a change must be 'seen,' its direction somewhat charted, before anything happens." (Jick, 1993, pg 75) A vision statement provides a clear picture of the end state desired. It provides participants a clear sense of what they are working to achieve and helps to focus their efforts. Further, "alignment between [corporate] strategies and processes is essential to radical change in business processes." (Davenport, 1993, pg 117) Additionally, "process change without strategy and

vision seldom goes beyond streamlining, with a resulting incremental reduction in time and cost." (Davenport 1993, p 119) A vision, therefore, is necessary if there is to be any hope for achieving the results desired.

#### **4. Understanding Existing Processes**

Until a clear understanding of the baseline process is developed, changes will produce haphazard results. By developing a firm understanding the existing process, one can more intelligently go about finding solutions for the processes' associated pathologies. Davenport articulates four reasons why it is important to develop a clear understanding of existing processes: (1) understanding existing processes facilitates communication among participants in the innovation initiative; (2) in most complex organizations there is no way to migrate to a new process without understanding the current one; (3) recognizing problems in an existing process can help ensure that they are not repeated in the new process; and (4) an understanding of the current process provides a measure of the value of the proposed innovation. (Davenport, 1993)

#### **5. Designing and Prototyping the New Process**

For the activity of designing new processes, Davenport states that "the design activity is largely a matter of having a group of intelligent, creative people review the information collected in earlier phases of the initiative and synthesize it into a new process" and that "the success or failure of the effort will turn on the particular people who are gathered together." (Davenport, 1993, pg 153)

In developing new process designs, he advocates using brainstorming sessions. The goal of these sessions is generating creative alternatives by all participants in a non-judgmental atmosphere. Graphic representation of the redesigns is recommended as it helps understand process flows.

Following redesign generation, participants must assess feasibility, risk, and benefits of the alternatives in terms of overall strategy and vision. Prototyping of redesigns is "an iterative process in which the fit between new process structure, information technology and organization is refined and re-refined." (Davenport, 1993, p 156) The output of this prototyping activity is the selection of a redesign for implementation.

#### **D. KOPER-LITE**

KOPeR-lite is a web-based version of The Knowledge-Based Organizational Process Redesign (KOPeR) tool that was originally implemented in a UNIX environment. KOPeR-lite is an automated tool created to help BPR novices develop process redesign alternatives without the benefit of extensive training in BPR or from the brainstorming sessions highlighted in Davenport's framework. It does this by making recommendations based on its analysis of the metrics inputted by the user for each measure listed in Table 2-1 below.

Measure	Graph Based Definition
Process Length	Number of nodes in longest path
Process Breadth	Number of distinct paths
Process Depth	Number of process levels
Process Size	Number of nodes in process model
Process Feedback	Number of cycles in graph
Parallelism	Process Size divided by Length
IT Support	Number of IT-support attributes
IT Communication	Number of IT-communication attributes
IT Automation	Number of IT-automation attributes
Organizational Roles	Number of unique agent role attributes
Process Handoffs	Number of interrole edges
Organizations	Number of unique agent org. attributes
Value Chains	Number of unique activity Value Chain attributes

Table 2-1. Example Process Measure (From Nissen, 2000)

Once these metrics have been entered, KOPeR-lite carries out its two primary functions: (1) pathology diagnosis and (2) transformation matching by referencing its knowledge base. This knowledge base is composed of three component parts: (1) process pathologies (2) redesign transformations and (3) process models. (Nissen, 2000). Pathologies are identified by a series of IF-THEN rules applied by KOPeR-lite to the user inputted process measurements. Based on KOPeR-lite's analysis of the metrics, it provides the user with feedback identifying process pathologies. These pathologies include those listed in Table 2.2 below.



Pathology Class	Sample Instance
Problematic process structure	Sequential process flows
Bureaucratic organization	Job specialization
Fragmented process flows	Process friction
IT infrastructure	Manual process
Checking" approach to quality	Review-intensive process
Centralized authority	Long decision chains
Under-utilized human potential	Training emphasis
Inhibitive leadership	Directive supervision
Centralized information	Central database architecture
Deficient core competency	Low IT expertise

Table 2-2. Pathologies and Pathology Samples (From Nissen, 2000)

KOPeR-lite then carries out its second function: that of transformation matching. The transformations it proposes are drawn from its transformation knowledge base following the application of another series of IF-THEN rules. The knowledge base is populated with expertise gleaned from BPR literature. Some of the transformations KOPeR-lite may propose are listed below and address the pathologies listed in Table 2-2.

Transformation Class	Sample Instance
Workflow reconfiguration	Process delinearization
Information technology	Shared database system
Organizational design	Case manager
Human resource	Team-based compensation
Information availability	Informant agents
Inter-organizational alliance	Supplier-managed inventory
Management & culture	Employee stock ownership

Table 2-3. Taxonomy of Redesign Transformations (From Nissen, 2000)

#### **E. HOW MIGHT THE MILITARY BENEFIT FROM PROCESS REENGINEERING EFFORTS**

There are numerous ways the military could benefit from using such a tool. Ask just about anyone in the military if they have experienced a process that they felt was less than efficient, and you will almost assuredly receive a long list of processes that they feel have room for improvement.

Some examples are listed below:

(1) USMC Personnel Assignment Process. There are numerous sources that a major command uses to find out who is coming to their command. Unfortunately, there is no one single source and the multiple sources have different degrees of accuracy. By being able to more effectively identify inbound personnel well in advance of their arrival, personnel sections would be able to make better assignments and offer inbound personnel with better assistance during the somewhat hectic permanent change of station process. Additionally, receiving commands would be able to make better plans based on projected personnel end strengths.

(2) Transition to Smart Card Technologies. There are numerous initiatives being pursued with regard to smart card technologies. Some of the issues raised are: How will we collect information from various sources for personnel, messing, billeting, armory, and others, and fuse them to be carried or accessed using a single card? How will the cards be issued and tracked? How will lost cards be taken out of the system and replacement cards issued? Failure to

address these processes prior to implementing this technology could result in significant problems.

(3) The Marine Corps' Total Force System (MCTFS) Initiatives. One such initiative is with regard to Unit Diary (UD) ownership. Information contained in MCTFS is updated periodically based on information submitted via UD<sup>1</sup>. Currently, only a unit's personnel administration section submits information via UD. All other sections that need to post information to MCTFS must submit the disparate source documents to the personnel section for processing. The information contained on these source documents is then re-entered into the UD's proprietary format for reporting to MCTFS. Once a UD is prepared, a hard copy is printed and submitted to the unit's Personnel Officer for review and certification. Once certified, the UD is forwarded for incorporation into MCTFS. However, MCTFS is not a real-time system. For non-pay related information, there is a delay in preparing, certifying, and submitting UD's. Pay related information is handled somewhat differently and is only incorporated this twice each monthly through the update and extract process. This is a source of inefficiency and causes problems most often seen with regard to personnel pay and promotion.

Total Force Administration System (TFAS) represents a new initiative in the realm of Marine Corps Personnel Administration. TFAS actually is a front-end system that is tied to MCTFS. Individual Marines will be able to change or request changes to certain information via the

---

<sup>1</sup> Unit Diaries (UD's) contain information reported in a proprietary format which automates the process of updating information contained in MCTFS.

web rather than relying on Marines working in his or her unit's personnel administration section. The unit Commander (e.g. company or battalion commanders) will have the ability to enter such things as training and morning report information directly into the system. Access at this level is referred to as second echelon access. Third Echelon will comprise three TFAS centers located at the major installations. These centers will submit information requiring expertise or oversight. Forth echelon consists of call centers which will be available 24 hours to provide assistance to system users. The highest echelon, fifth echelon, is Headquarters, U.S. Marine Corps (M&RA).

How can TFAS best be used to increase the efficiency of current personnel administration processes? Considering the plethora of information that must be updated in MCTFS on a routine basis, removing any bottle necks and speeding up the process would result in more accurate, timely information being maintained and saving numerous man-hours of labor.

(4) Personnel Housing Assignment. The recent push to privatize base housing presents a good opportunity to review current housing management processes. Again, there are numerous sources that may be accessed to determine when current residents will be moving and when future service members who want to be assigned to base housing will arrive. How can we better manage and coordinate this information.

(5) Repair parts/supply requisitioning process. This area has seen numerous initiatives in recent years. From migrating to a more just-in-time inventory type system to

eliminating non-value added steps, improvements have been made. However, it is still a problematic area where efficiencies can be gained and increased effectiveness may be realized.

These are just a few problem areas within the military that could benefit from the application of a BPR tool such as KOPeR-lite to develop process redesigns. The results of implementing more efficient, effective process may include:

- Cost savings;
- Reduction in the number of personnel needed in the execution of various processes;
- Increased customer satisfaction. (The customer ranges from individual service members to the nation, from individual commands to civilian contractors.)

#### **G. SUMMARY**

The goal of BPR is to produce quantum leap improvements in the efficiency and effectiveness in business processes. The need to conduct BPR has not diminished since the term was originally coined. Rather, the significant improvements in the realm of technology, rapid improvement in information availability (driven largely by advances in technology), as well as the implementation of new technologies without changing underlying processes all necessitate continued or renewed BPR efforts.

Davenport provides us with a framework within which to pursue BPR efforts. KOPeR-lite provides us with a tool to

automate two knowledge intensive steps in the BPR process:  
(1) pathology diagnosis and (2) transformation matching.  
The goal of the subsequent chapter is validate the benefit  
of KOPeR-lite.

### III. BUSINESS PROCESS REENGINEERING EXPERIMENT

#### A. EXPERIMENTAL DESIGN

The hypothesis to be tested in the experiment is: Will using KOPeR-lite result in BPR novices producing (1) a greater number of redesign alternatives and (2) redesigns that are higher in quality with regard to feasibility and overall impact?

Two test groups are drawn from the pool of graduate students attending the Naval Postgraduate School. Students selected to participate in the experiment are screened to ensure novice status, meaning they had no prior BPR experience, and each receives a one-hour period of instruction on re-engineering. This period of instruction was given well in advance of the laboratory period where they would be tasked with developing redesigns for the case contained in Appendix A. This afforded the students the opportunity to assimilate the information presented during the period of instruction.

The experiment was conducted during the course of a single, two hour long laboratory period during which the students are instructed to develop as many distinct redesign alternatives as they can. Given the time limitation, speed of redesign generation is a significant factor in the number of redesigns generated per subject. Effectiveness of the redesigns is another major consideration.

For the laboratory period, the first group is tasked to generate redesigns *without* the use of KOPeR-lite and the second *with* KOPeR-lite.

The redesigns generated are then analyzed based on the following criteria:

- Number of redesigns generated
- Delinearization of process flows
- Enablers:
  - Information technology
  - Organizational Design (other than through the injection of IT)
- Change in the number of activities
- Change in the number of feedback loops
- Change in the number of handoffs
- Clarity of the redesign, and
- Impact

#### **1. Number of Redesigns Generated**

Redesigns needed to be distinct in that a reader should be easily able to determine where one redesign description ends and another begins. In some cases, redesigns are presented simultaneously in a fashion such that one is unable to discern which features belong to which redesign. In such cases, the analyst was forced to use his or her best judgment to determine the number of redesigns generated by the experimental subject.

#### **2. Delinearization**

Delinearization means that two or more activities that were carried out sequentially in the baseline process are carried out simultaneously in the redesign. Activities could be grouped together in the redesign without necessarily resulting in delinearization. For example, the design and test activities could be merged into a single



"software development" cell where the coders must still wait for the designers' output before they can commence work. Therefore, the flow is still sequential. However, if this "software development" cell uses cyclic development or modular design, the designers could pass on to the coders the design for a single module so that they may commence coding while the designers continue designing additional modules. In this case, delinearization has been incorporated into the redesign. A binary (yes/no, 1/0) determination was made for this criterion.

### **3. Enablers**

An enabler is anything that results in increased process efficiency or effectiveness. Enablers include, but are not limited to: information technology such as shared databases, computer networks, electronic mail (e-mail), automated forms, video teleconference, computer aided software engineering (CASE) tools; organizational design enhancements such as grouping of related activities to facilitate information exchange and work coordination or inclusion of a case manager who would have oversight over a group of activities; and human resource factors such as enhanced training or other personnel support initiatives. Each example of an enabler incorporated into a redesign was counted and the overall number of enablers per redesign tallied. An enabler that was used multiple times within a single redesign was only counted once. For example, e-mail may be used in four activities within the redesign, however the e-mail enabler is counted only once for that redesign.

#### **4. Change in the Number of Activities**

The number of activities in a redesign process may increase or decrease from the number included in the baseline. It is hoped that by adding or removing an activity, the overall efficiency and effectiveness of the process workflow will be enhanced. For example, the sales activity might be eliminated as superfluous under the supposition that customers can communicate their software needs to the software development company via telephone or a website vice going through a software development marketing agent.

#### **5. Change in the Number of Feedback Loops**

A feedback loop occurs any time information or a product from one activity is provided to an activity earlier in the process. For example, if the Independent Verification and Validation (IV&V) activity finds a flaw or deficiency in the software product, IV&V's finding must be sent to earlier activities (e.g., Design and/or Code) so that the deficiencies can be addressed. Sometimes, as in the case of micromanagement, excessive feedback loops inhibit efficiency and should be eliminated.

#### **6. Change in the Number of Handoffs**

The number of handoffs occurring in the process workflow is dependent on the overall number of activities as well as the manner in which they are carried out. An example of how the number of handoffs may be reduced while keeping the overall number of activities the same is depicted in Figure 3-1.

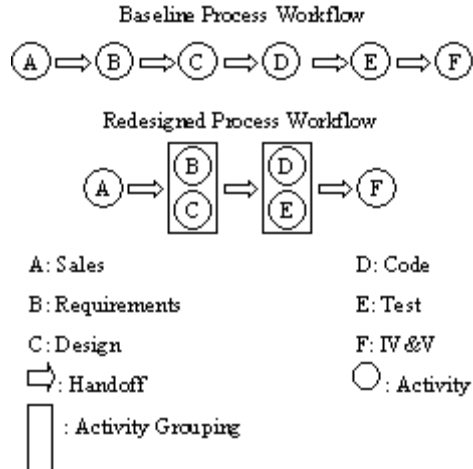

Figure 3-1. Redesign Example Highlighting a Reduction in the Number of Handoffs

In this example, activities B and C as well as D and E are combined into two integrated activities. By doing this, the number of handoffs is reduced from five to three.

## 7. Clarity of the Redesign

Essentially, this is the ease with which one is able to discern the features of a proposed redesign. A scale from one to three was used. The following criteria were applied in attempts to objectify this largely subjective metric:

- 1 - not very clear; no redesign graphic, redesign metrics are not included, textual description fails to enhance a reader's ability to discern what the author is trying to convey.
- 2 - clear; a redesign graphic or metrics are provided, textual description provides the reader with a good understanding of the author's redesign. Redesigns where the author provided both a redesign graphic and metrics but provided a mediocre textual description are also assigned a value of clarity value of 2.

- 3 - very clear; both a redesign graphic and redesign metrics are included and the textual description provides the reader with an exceptionally clear mental picture of the author's redesign.

## **8. Impact**

A scale from one to three is used. The following criteria were applied to objectify this basically subjective category:

- 1 - infeasible or feasible but negligible impact
- 2 - feasible and moderate gains in efficiency and effectiveness of the process workflow anticipated
- 3 - feasible and significant gains in efficiency and effectiveness of the process workflow anticipated

## **B. ASSESSMENT PROCEDURE**

The software development case contained in Appendix A was presented to two groups of graduate students at the Naval Postgraduate School. The redesigns produced by each experimental subject were then analyzed based on the criteria listed in Section A above. Two separate analyses were conducted: one by the author and another researcher. Once these separate analyses were completed, both researchers met to discuss their individual findings and to generate a single, integrated analysis. Once the integrated analysis was generated, several methods of statistical manipulation were applied to the quantitative data. The outcome of this analysis provides the basis for the conclusions drawn at the end of this chapter. Appendix B documents individual and integrated analyses as well as

providing explanatory comments documenting the rationale behind the quantitative assessments.

### **C. EXPERIMENTAL RESULTS**

The data contained in Appendix B were then distilled and entered into a spreadsheet for statistical analysis. First the independent analyses were reviewed to determine interjudge reliability. Following this, an integrated analysis was conducted to determine whether or not KOPeR-lite provided the BPR novices in the experimental group with any quantifiable benefits.

#### **1. Interjudge Reliability**

As stated above, one of the first goals was to identify any significant interjudge differences. Three basic metrics were used: arithmetic mean, standard deviation, and correlation. Ideally, there would be no difference in arithmetic means or standard deviations, and unity correlation for each variable between the two researchers would exist. Departures from the "ideal" results are discussed below.

##### **a. Delinearization**

Delinearization was a binary criterion. A redesign either did or did not apply delinearization, resulting in the assignment of a 1 or 0 respectively. Differences stem from an initial difference of opinion about what constituted delinearization (note the particularly low correlation of 0.22415). It was decided that a value of 1 would be assigned only for those

redesigns where activities were explicitly identified to be done in parallel or where modular development techniques in conjunction with a development team concept. After reconciling these initial differences in opinion, the two researchers attained 98.7% agreement on delinearization assessment.

***b. IT Enablers***

Prior to discussing their ratings, the correlation between the two researchers on this criterion is 0.86 indicating that significant agreement exists. Following discussions, the two researchers attained 100% agreement.

***c. Non-IT Enablers***

One judge focused exclusively on IT enablers and failed to take into account any other enablers incorporated in the various redesigns. Since data for this criterion was only available from one of the two judges, no conclusions with regard to interjudge reliability can be drawn. Following discussions to reconcile difference, however, the two researchers attained 100% agreement.

***d. Non-value Added Activities Removed***

Prior to discussing their ratings, the correlation between the two researchers on this criterion is 0.96 indicating that significant agreement exists. Following discussions, the two researchers attained 100% agreement.

***e. Change in Number of Hand-offs***

Prior to discussing their ratings, the correlation between the two researchers on this criterion is 0.84 indicating that significant agreement exists. Following discussions, the two researchers attained 100% agreement.

***f. Clarity***

Significant differences existed at first between the two judges with regard to clarity (note the somewhat low correlation of 0.53 between their two sets of ratings prior to discussion). This can be explained by the differences in techniques the two judges applied to assign a value this criterion. One researcher established a clear set of criteria, as outlined above, which was applied to each redesign to determine what value should be assigned. The other researcher used a somewhat less systematic, more qualitative assessment in the assignment of clarity scores. Following discussions to reconcile differences between the two researchers' scores, 100% agreement was attained.

***g. Impact***

Prior to discussing their ratings, the correlation between the two researchers on this criterion is 1.0 indicating that the ratings assigned by both researchers matched exactly.

**2. Integrated Analysis**

After reaching consensus between the two analyses, an integrated analysis was performed. First, a correlation matrix was developed to see if any pairs of criteria seemed to move together. The results of this analysis are contained in the table below.

Correlation Matrix	Redesigns per subject	Delinearization (0=N; 1=Y)	IT enablers	Non-IT enablers	non-value added items removed	change in # of feedback loops	change in # of hand-offs	Clarity	Impact
Delinearization	N/A	xxx	-0.094011639	0.519674637	-0.171789602	-0.150647456	-0.129574841	0.061349982	0.342864196
IT enablers	N/A	xxx	xxx	-0.045950545	-0.276677323	-0.164370749	-0.315067908	0.067106949	0.501988309
non-IT enablers	N/A	xxx	xxx	xxx	0.013144741	-0.141064123	-0.026438973	0.242303425	0.511553536
non-value added	N/A	xxx	xxx	xxx	xxx	0.378130105	0.648540606	-0.027253437	-0.220458969
feedback loops	N/A	xxx	xxx	xxx	xxx	xxx	0.619683511	-0.128009047	-0.195219569
handoffs	N/A	xxx	xxx	xxx	xxx	xxx	xxx	-0.162987375	-0.341127616
clarity	N/A	xxx	xxx	xxx	xxx	xxx	xxx	xxx	0.395138052
impact	N/A	xxx	xxx	xxx	xxx	xxx	xxx	xxx	xxx

Table 3-1. Correlation Matrix.

Numbers approaching unity would signify that the two criteria move together; that perhaps they are measuring the same thing. As can be seen in the table above, such is not the case in this analysis. This provides evidence that the eight criteria being looked at are not redundant with one another.

The next step was to test the null hypothesis: "KOPeR-lite does not provide any significant benefit to novices developing BPR redesigns." To test this hypothesis, the data set was first broken down into four subsets: (1) Without KOPeR Group (with outliers), (2) Without KOPeR Group (without outliers), (3) With KOPeR Group (with outliers), and (4) With KOPeR Group (without outliers). "Outliers" refers to the subjects who analyzed the baseline process in a significantly different manner than the majority of subjects. The typical baseline analysis broke



the process down into six activities with five handoffs and two feedback loops as is depicted below.

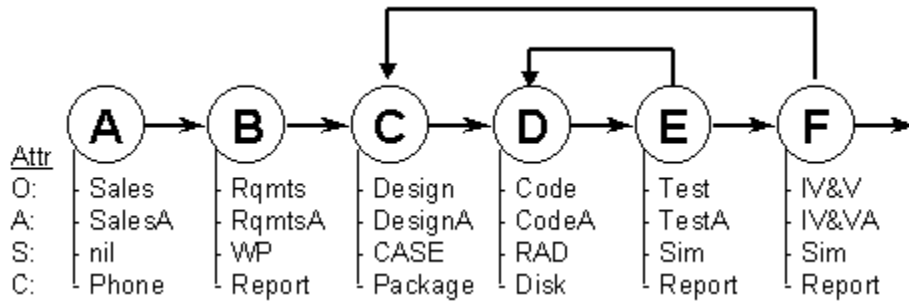

Figure 3-2. Typical Baseline Analysis for the Software Development Case (see Appendix A)

The arithmetic mean, standard deviation and confidence intervals for each of the metrics for the two "Without KOPeR-lite" groups were then calculated. Confidence intervals were set at both 0.95 and 0.90. Next, the arithmetic mean and standard deviation for each of the eight criteria in the two "With KOPeR" groups were calculated. These means were then compared to the confidence intervals of their respective "Without KOPeR" sets to identify any significant differences. Where means for the "With KOPeR" subsets fell outside the confidence intervals for the "Without KOPeR" subsets, we have evidence that KOPeR does yield significant benefit to the BPR novices in this experimental group. A textual summary of the results is provided below.

	<b>W I T H O u t l i e r s</b>				
	Without KOPeR	With KOPeR	95% confidence Interval	90% confidence Interval	70% confidence Interval
# redesigns per subject	2.1	1.94	<b>Within</b>	<b>Within</b>	<b>Below</b>
Delinearization	0.2727	0.2727	<b>Within</b>	<b>Within</b>	<b>Within</b>
IT enablers	3	3.6363	<b>Above</b>	<b>Above</b>	<b>Above</b>
Non-IT enablers	.97727	1.2424	<b>Within</b>	<b>Above</b>	<b>Above</b>
Non-value added items removed	0.15909	-1.4545	<b>Below</b>	<b>Below</b>	<b>Below</b>
Change in # of feedback loops	-0.3409	-.57575	<b>Within</b>	<b>Within</b>	<b>Within</b>
Change in # of handoffs	-1.8409	-2.7878	<b>Below</b>	<b>Below</b>	<b>Below</b>
Clarity	1.6136	1.9090	<b>Above</b>	<b>Above</b>	<b>Above</b>
Impact	1.81818	1.9393	<b>Within</b>	<b>Within</b>	<b>Within</b>

Table 3-2a. Comparison of Means for the "With Outlier" Groups.

	<b>W I T H O U T O u t l i e r s</b>				
	Without KOPeR	With KOPeR	95% confidence Interval	90% confidence Interval	70% confidence Interval
# redesigns per subject	2.06	1.93	<b>Within</b>	<b>Within</b>	<b>Below</b>
Delinearization	0.324324	0.24137	<b>Within</b>	<b>Within</b>	<b>Below</b>
IT enablers	2.97297	3.34482	<b>Within</b>	<b>Within</b>	<b>Within</b>
Non-IT enablers	1.027027	1.31034	<b>Within</b>	<b>Above</b>	<b>Above</b>
Non-value added items removed	-0.027027	-0.20689	<b>Below</b>	<b>Below</b>	<b>Below</b>
Change in # of feedback loops	-0.16216	-0.17241	<b>Within</b>	<b>Within</b>	<b>Within</b>
Change in # of handoffs	-1.135135	-1.44827	<b>Within</b>	<b>Within</b>	<b>Below</b>
Clarity	1.567567	1.89655	<b>Above</b>	<b>Above</b>	<b>Above</b>
Impact	1.810810	1.86206	<b>Within</b>	<b>Within</b>	<b>Within</b>

Table 3-2b. Comparison of Means for the "Without Outlier" Groups

For criteria where the With KOPeR-lite group produced superior results, the appropriate cell in tables 3-2a and 3-2b are lightly shaded. For those with no significant

difference, the cell contains diagonal hatches and those where the With KOPeR-lite group's performance was inferior, the cell contains cross-hatches.

#### **D. FINDINGS**

Based on the results summarize in Table 3-2, several differences between redesign performance of the two subject groups (i.e., With and Without KOPeR-lite) are significant and worthy of comment.

Looking first at the With-Outliers (i.e., whole) Group, notice the KOPeR-lite group employed significantly more IT enablers (95% level) and non-IT enablers (90% level). This KOPeR-lite group also decreased the number of handoffs significantly (95% level), and the redesign descriptions of this group were significantly clearer (95% level). These are all considered positive results, in that such redesigns are generally considered superior according to contemporary re-engineering theory.

Alternatively, notice the number of non-value-added items removed as significantly *lower* for the KOPeR-lite group. Since non-value-added items are, by definition, not essential for process performance, a superior redesign would remove *more* such items, not less. Hence, the KOPeR-lite group appears to perform worse than the control group according to this criterion.

Notice the change in number of feedback loops is not significantly different between the two groups nor is the difference in number of redesigns generated per subject. Most surprising is that, despite the "superior" *theoretical* redesign performance noted above, the difference in potential impact of redesigns developed across the two

groups is also insignificant. Thus, although the use of KOPeR-lite produces several differences that are considered positive in terms of re-engineering theory, these empirical results suggest such theory may require an update, for judged redesign performance is indistinguishable between the with- and without-KOPeR-lite groups.

These results suggest that the key benefits of using KOPeR-lite stem principally from the use of enablers and clarity of redesign descriptions. And, although the reduction in process friction expected from decreasing handoffs in the process should improve performance in terms of cycle time, such performance improvement was not judged to be significant in terms of redesign impact.

Results of the without-outliers groups are similar, except that many of the differences are not as significant between the With- and Without-KOPeR-lite Groups when they are removed. For instance, the number of IT enablers and change in the number of handoffs are considerably less significant between these groups than between the With-Outliers Groups as noted above. However, the difference in delinearization between the With- and Without-KOPeR-lite Groups is marginally significant when the outliers are removed. Consistent between the with- and without-outliers analyses are differences in non-IT enablers used and clarity of the redesigns. Also as above, differences in impact between the With- and Without-KOPeR-lite Groups are insignificant. Thus, some KOPeR-driven differences in redesign performance noted above are mitigated when outliers are removed, but the difference in clarity of redesign descriptions remains prominent. These findings

suggest implications in terms of KOPeR-lite use as discussed below.

Referring back to the data contained in Table 3-1, there are some correlations that warrant some discussion. For instance, the correlation between "change in number of handoffs" and both "non-value added items removed" and "change in number of feedback loops" are 0.65 and 0.62 respectively. Upon reflection, however, this intuitively makes sense. If you remove processes, the likelihood that number of handoffs will be reduced is pretty high. Likewise, if you reduce the number of handoffs, there is a reasonable chance that one or more feedback loops may be eliminated.

Additionally, the correlation between "Impact" and both "IT enablers" and "Non-IT enablers" are higher than most of the other correlations with values of 0.50 and 0.51 respectively. Again, this correlation seems somewhat intuitive: The greater the number of enablers incorporated into a process redesign the greater the impact the redesign can be expected to effect when implemented.

#### **E. SUMMARY**

The findings from this experiment revealed a number of anticipated results as well as surprises. We had anticipated KOPeR-lite use to promote incorporation of additional enablers into process redesigns, for the system can augment a person's memory and level of redesign expertise. For instance, where a novice in terms of process redesign may not be aware of certain enablers (e.g., case manager, delinearization), KOPeR-lite can

suggest the use of such enablers when its diagnostics imply they are appropriate. Additionally, because KOPeR-lite employs a consistent, systematic approach to process redesign (e.g., measurement, diagnosis, matching), we anticipated that redesign descriptions would reflect some of this systematic consistency in terms of clarity. These can both be viewed as positive benefits stemming from KOPeR-lite use.

Alternatively, we were quite surprised that KOPeR-lite did not produce significant differences in terms of potential impact of the redesigns generated. Following re-engineering theory, we anticipated that incorporation of additional enablers as noted above would lead to greater impact in terms of performance improvement. Although the impact associated with redesigns produced by the With-KOPeR-lite Groups were indeed judged to be greater than those generated by the Without-KOPeR-lite Groups, we found no significant differences in terms of this measure.

One explanation for this is the relatively small sample ( $n = 44$ ) employed in the experiment. It could be that, with more test subjects, the positive differences in terms of redesign impact would become significant. Perhaps a future study could test this supposition.

Another explanation could be that the judges' criteria used to score the various redesigns according to this criterion were flawed. It could be that, despite the judges drawing from re-engineering theory to assess the potential impact of various redesigns, physical processes redesigned using KOPeR-lite may indeed exhibit

statistically significant performance improvement. But this also remains for a future study to examine.

A third explanation is, KOPeR-lite lacks the kind of strong domain knowledge required to make a significant difference in terms of novices' redesign performance. With the incorporation of additional process measures, diagnostic tests and redesign rules, for instance, this system may prove to enhance redesign performance in ways the current KOPeR-lite system cannot. Examining this possibility will require modification of KOPeR-lite and another experiment to assess the impact of the modified system on redesign performance, which as above, is a matter for a future study.

In terms of the present research, KOPeR-lite will be used to take advantage of the things it does well (e.g., identifying enablers, reducing handoffs, clarity of redesign descriptions), but the researcher will not rely upon KOPeR-lite alone. Redesign of the Marine Corps process is presented in the following section.

THIS PAGE INTENTIONALLY LEFT BLANK



## IV. THE PERSONNEL ASSIGNMENT PROCESS IN THE USMC

### A. DESCRIPTION OF THE CURRENT PROCESS

One process that has been identified by personnel management experts in the Marine Corps as problematic is the permanent change of station (PCS) orders process for officers, particularly after their first tour of duty. This problem has been articulated by not only individuals who participate in the planning and assignment process, but also by the people who's lives and careers are most prominently affected by how well (or poorly) the process is carried out. Problems include numerous databases that capture various subsets of information where these databases are loosely, if at all, integrated. As a result, the information contained in various reports generated by tapping into the databases does not reflect an accurate picture of the current manning situation. Numerous issues plague officers who are due for orders. Two of the most common complaints are with regard to the timeliness with which they are issued orders and the inability of individual officers to access a list of current and projected billet vacancies so that they can more precisely articulate their desires for future assignments<sup>2</sup>.

Before we can consider how and when individuals are issued PCS orders, we must first understand the Marine Corps underlying framework for manpower management. Table of organizations (T/O's) are established for all units. T/O's are listings of all the jobs associated with a

---

<sup>2</sup> The U.S. Air Force has a mechanism in place where all officers can access a current list of available billets and communicate directly with the individual or department responsible for making future assignments.

particular command. Information contained on a T/O includes: T/O number, billet line number, billet rank, and billet description.

Each unit is then assigned a staffing priority level. These levels are: (1) V-unit, which are units that consistently maintain a high state of readiness so that they may deploy at a moment's notice, (2) priority, (3) excepted, which include joint billets and other critical billets, and (4) all others. V-units are staffed at 100% of their authorized strength. Priority commands are staffed at 95%, excepted commands at 99%, and all others at 80%.

Another source of information used in managing personnel is the Marine Corps Total Force System (MCTFS). This database contains personal information about each and every Marine. Included are such items as: name, social security number, date of birth, rank, date of rank, current address, phone number, record of emergency data information, blood type; training information such as rifle, pistol, swim qualifications, current physical fitness test (PFT) results, primary and secondary military occupational specialty codes; uniform size information for such things as gas mask, camouflage blouse, camouflage trousers; and current tour information such as T/O number, line number, billet rank, billet name, billet MOS, and date current tour began among others. For the purposes of this chapter, the personal information and current tour information will be of primary importance.

Based on the information contained in T/O's, established staffing goals, and MCTFS, a Personnel

Management Report<sup>3</sup> (PMR) is generated. One of the uses of this report is to plan future personnel assignments.

In order to determine future assignments, the following are key elements of information:

- what billets are to be staffed,
- which of these billets are currently vacant, and
- when individuals are projected to rotate out of their current assignment. (This can be calculated by adding the appropriate tour length to an individual's "date current tour began" (DCTB) entry contained in MCTFS.)

A tour of duty is generally three years in length of assignments within the continental United States (CONUS) and outside of the continental United States (OCONUS) accompanied tours, and one year for OCONUS unaccompanied tours. Though the process is essentially the same regardless of tour length or location, for simplicity, THE focus is on three year CONUS or accompanied OCONUS tours for the remainder of this section.

Once an individual has spent two years in their current assignment, they have fulfilled the obligated service requirement incurred for their most recent CONUS PCS move. HQMC can, therefore, begin considering them for a future assignment though their goal is for individuals to serve three years in their current assignment before ordering them to report to a new command. However, since

---

<sup>3</sup> The PMR is a reporting mechanism developed by a gentleman named Mr. Marsh back in approximately 1966. It reports such information as the current personnel inventory, proper staffing inventory (which is driven by such factors as yearly authorized strength, yearly on hand strength, T/O allowance, and T/O staffing goal, as well as individual's rank, MOS, etc.. It is connected to MCTFS only at the front- and back-ends, but doesn't directly interact with MCTFS. For instance, information about a person on the PMR will not "trigger" a move in MCTFS.

their service obligation has been fulfilled, these individuals are referred to as "movers."

In the orders process, there are four primary stakeholders. These are the "mover," monitors<sup>4</sup>, as well as the losing and gaining commands.

At about the two-year mark, the mover has the option of communicating his or her follow-on assignment preferences to his or her respective monitor. Future duty preferences can be communicated to the monitor in any number of ways, to include:

- the duty preference codes listed by an individual on their performance evaluations (these eventually get reported into the MCTFS);
- submitting duty preference via the website maintained by the Manpower Management Officer Assignment (MMOA) branch (a standalone database accessible only by MMOA staff and individuals updating their personal record);
- email or telephone communications between the monitor and individual officer, or
- conversations held when the monitor and individual officers are able to meet in person (such as during MMOA's annual "road show" where all the monitors visit the major installations with the primary intent of meeting with and discussing future assignments with individuals who are nearing the end of their current tour).

Note that only one of these methods (the listing of duty preference codes on one's performance evaluation)

---

<sup>4</sup> Monitors are individuals working in the HQMC, Manpower and Reserve Affairs, Manpower Management [MRA (MM)] section that manage personnel assigned the military occupational specialties (MOS's) they've been assigned to manage. They must match officer desires with needs of the Corps in the short run, but also to ensure that a sufficient number of officers are trained, experienced, and qualified to command and staff the Corps in the future.

results in an update to the information contained in MCTFS, the database used to generate the PMR.

Currently, the mover does not have access to information about which billets are vacant or due to become vacant. Only the monitor has access to this information.

Armed with a list of movers, the movers' preferences, and a list of current and projected billet vacancies, the monitor begins the process of identifying which individuals will be assigned to current and upcoming billet vacancies. The monitor must apply the criteria outlined in MCO P1300.8G Ch 4 in determining future assignments.

- needs of the Marine Corps,
- MOS/Billet variety<sup>5</sup>,
- Availability of the individual,
- Overseas control date (OCD)<sup>6</sup>,
- Seniority<sup>7</sup>, and
- Individual preferences.

---

<sup>5</sup> Monitors take care to ensure officers have the opportunity to perform in their MOS including command at the junior ranks, and in other staff and instructor billets, as well as have the opportunity to attend appropriate military education, to ensure they are "fully qualified." Needs of the Corps also demand officers be assigned to recruiting, instructor, Marine Corps Security Force, Marine Corps Recruit Depot, acquisition, joint, and Navy staff duty.

<sup>6</sup> The Overseas Control Date (OCD, or OSCD on the Master Brief Sheet) remains a fair way to determine an officer's place in the "queue." The OCD may take precedence over other assignment factors considered by the monitor. The monitor will determine the number of overseas "fills" required by MOS, and compare that to officers' OCD. The older the officer OCD, the more likely the assignment to an overseas tour.

<sup>7</sup> An officer's seniority must be taken into account to lessen the possibility they will not be promoted out of the assignment prior to completing the prescribed tour length.

<sup>8</sup> Note that individual preference is the last criteria applied when the monitor makes assignments.

In addition to the criteria outlined in P1300.8G Ch 4, the monitor must also take into account the following criteria outlined in MMOA's Officer Development Handbook:

- Staffing Goal<sup>9</sup>
- Authorized Strength Report (ASR)<sup>10</sup>,
- Time in geographic location<sup>11</sup>, and
- An officer's availability<sup>12</sup>.

Per MMOA's Officer Development Handbook:

---

9 The Staffing Goal is the "best" distribution of available Marines to all authorized billets. Each year, a computer Staffing Goal Model is run to produce a preliminary "fit" of available officers by grade and PMOS to authorized billets. MMOA's staffing goal model combines those billets that CG, MCCDC has authorized to be manned with the available officer inventory. Monitors manually review the model and make necessary changes.

10 The Authorized Strength Report (ASR) is a CG, MCCDC (TFSD) document produced semi-annually which completes the manning process. The ASR converts the macro Troop List manning numbers into the micro level of detail. Specifically, the ASR allocates manning to units (MCCs) by grade and MOS. Remember, manning is about billets, not people. Through the manning process, the Marine Corps is "buying" xxx number of billets. TFSD then determines what percent of those authorized billets are actually filled. The ASR is the linking document between MCCDC and M&RA. The ASR is delivered to MM Division for use in the staffing goal models (the staffing process-distribute current inventory) and MP Division for input into the GAR (the development manpower plans process-build future inventory).

11 Three years has long been the standard tour length. ALMAR 075/96 of 4 Mar 96, Increasing the Number of 4 to 5-Year geographic location tours, outlined the "standard" 3-year policy, and published the CMC's guidance for 4 to 5-year tours, and the analysis by the 1995 General Officer Symposium. The consensus of the Corps' senior leaders indicated that an increase in the number of 4 to 5-year geographic location tours would benefit both the Corps and the individual Marine by increasing unit stability, reducing family turbulence and reducing PCS costs. The CMC approved the General Officer Symposium recommendation and directed that the number of 4 to 5-year geographic location tours be increased whenever the needs of the Corps and individual preferences can be accommodated by the longer tour. Extended tours would include extension on station with the same command, split tours between commands at the same installation, and low cost PCS and PCA orders between commands in the same geographic location. While this change is a clear move toward an increase in tour length, it is not a guarantee that all Marines will serve 4 to 5 years at the same command or in a particular geographic location. Officers interested in remaining in place for longer tours of duty should inform their monitor.

12 An officer's availability will depend on prescribed tour lengths, internal and external billet requirements, and allowable exceptions to assignment policy. Obviously, monitors must minimize the number of assignments that require tour length waivers.

Once a monitor has a potential officer for an assignment, the assignment enters an approval process that varies with type and grade.

A company grade monitor's potential assignment for a warrant officer, chief warrant officer, lieutenant, or captain is reviewed by a "center desk" major as a quality assurance check and approval. If the assignment requires a waiver of policy, it is reviewed by the aviation or ground section head (a lieutenant colonel), and then can be approved by the Officer Assignment Branch Head (a colonel). If the assignment involves a move at 2 years or less, the Personnel Management Division Director (a major general) reviews it. If the assignment is to a joint or acquisition billet, the Joint Officer Management Officer or Acquisition Management Officer reviews the assignment and provides a recommendation to the Officer Assignment Branch Head.

A field grade officer's assignment is reviewed by the Aviation or Ground Monitor Section Head (a lieutenant colonel), by the aviation or ground colonel's monitor (a colonel), and by the Officer Assignment Branch Head (a colonel). If the assignment is to a joint or acquisition billet, the Joint Officer Management Officer or Acquisition Management Officer reviews the assignment and provides a recommendation to the Officer Assignment Branch Head. The Branch Head makes a recommendation to the Personnel Management Division Director (a major general)

Once the assignment proposed by the monitor has been approved, the monitor then issues orders<sup>13</sup>.

Unlike with orders for enlisted services members which are issued using the Automated Order Writing Process

---

<sup>13</sup> Orders are the authoritative document that tells the mover: (1) when he or she is to detach from their currently command, (2) what command he or she is to report to (3) when he or she is to report to their future command, (4) and under what set of appropriation data the orders are to be executed.

System(AOWPS)<sup>14</sup>, orders for officers can be issued using any number of ways, to include: (1) AOWPS, (2) verbal or telephonic (these are eventually backed up by written orders of some type), (3) e-mail, (4) FAX, (5) Defense Message Service (DMS), (6) letter-type. Of these methods, only the first results automatically updating the information contained in MCTFS. For all other methods of issuing orders, MCTFS must be manually updated, either by HQMC prior to the officer's detaching date or by the receiving command once he or she reports in.

The potential delay in updating the information contained in MCTFS poses some problems. Until MCTFS is updated, the information contained in the PMR will not be accurate. If the PMR is inaccurate, the effectiveness of that report as a planning tool is greatly diminished. If the PMR is inaccurate, the staffing goal model used in the Manpower Management section at HQMC will not portray an accurate picture.

---

<sup>14</sup> Three years has long been the standard tour length. ALMAR 075/96 of 4 Mar 96, Increasing the Number of 4 to 5-Year geographic location tours, outlined the "standard" 3-year policy, and published the CMC's guidance for 4 to 5-year tours, and the analysis by the 1995 General Officer Symposium. The consensus of the Corps' senior leaders indicated that an increase in the number of 4 to 5-year geographic location tours would benefit both the Corps and the individual Marine by increasing unit stability, reducing family turbulence and reducing PCS costs. The CMC approved the General Officer Symposium recommendation and directed that the number of 4 to 5-year geographic location tours be increased whenever the needs of the Corps and individual preferences can be accommodated by the longer tour. Extended tours would include extension on station with the same command, split tours between commands at the same installation, and low cost PCS and PCA orders between commands in the same geographic location. While this change is a clear move toward an increase in tour length, it is not a guarantee that all Marines will serve 4 to 5 years at the same command or in a particular geographic location. Officers interested in remaining in place for longer tours of duty should inform their monitor. Per MCO P1000.8, par 1201.4, "The Automated Orders Writing Process (AOWP) ...is designed to allow HQMC to forward PCS orders data to a Marine's command via MCTFS. **AOWP is the primary method of issuing orders for enlisted Marines.**" No such standard exists for issuing orders to officers.



The process discussed above can be roughly distilled into the activities pictured below:

A process representation is provided below and a textual description follows:

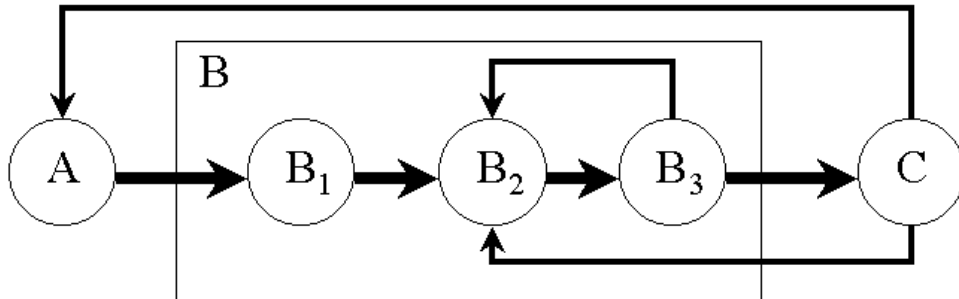

		ACTIVITIES					
		A	B	B <sub>1</sub>	B <sub>2</sub>	B <sub>3</sub>	C
ATTRIBUTES	O:15	Planning	Personnel/Career Management	Mover and Billet Vacancy ID	Mapping of Mover to Billet	Order Approval	Orders issuance
	A:16	Planners		Monitor	Monitor	Monitor's Supervisor	Monitor
	S:17	• T/O dB • PMR* • MCTFS		• S/G model • MMOA stand-alone, web-based duty pref dB • word processor • MCTFS	• stand-alone dB or spreadsheet • e-mail • word processor	• word processor • e-mail	• AWOP • DMS • word processor • e-mail • MCTFS •
	C:18	• PMR*		• PMR	• telephone • FAX	• telephone • FAX	• telephone • FAX

\* The PMR is software tool that generates a report having the same name.

15 "O" designates the performing organization in the process (e.g., Sales Department, Requirements Department)

16 "A" designates the agent role in the process (e.g., Sales Agent, Requirements Agent)

17 "S" designates the information technology employed for support in the process (e.g., word processor (WP), computer-aided software engineering (CASE) tool)

18 "C" designates the media/technology employed for communication in the process (e.g., phone, report)

Size	5	IT support	11
Length	5	IT communication	3
Handoffs	4	IT automation	0
Feedback Loops	3		

Figure 4-1. Baseline Orders Process for USMC Officers

- Activity "A": This activity includes producing and maintaining the T/O's, running the PMR tool to generate the PMR, and determining a staffing priority each command (e.g., V-unit, priority, etc); essentially, all the high level activities.
- Activity "B": This is where the "rubber meets the road." Monitors set about determine who will be moving and when, what billets are or will need to be filled, apply the various criteria outlined by both MCO P1300.8G and the Officer's Development Handbook, propose assignments, and get approval for these proposals. If the proposal is not approved, the monitor set about modifying the proposal to satisfy the requirements articulated by his or her supervisor.
- Activity "C": This is where the mover discovers how well the process works. The monitor disseminates the orders. MCTFS is updated (either automatically or by hand depending on the method used to disseminate the orders). Once the mover receives his or her orders, if there is some problem with the assignment or detachment/reporting dates, the mover can communicate with his or her monitor to get the orders modified to better meet his or her needs. With the orders issued, mover in receipt of the orders, and MCTFS updated, the process can begin anew.

Having completed an analysis of the baseline process, the metrics contained in Figure 4-1 were inputted to KOPeR-lite. The recommendations generated by KOPeR-lite are contained in Appendix C. Explanations of KOPeR-lite's Redesign Recommendations are contained in Appendix D.

Using these recommendations as a point of departure, two redesign alternatives are provided below.

## **B. PROPOSED REDESIGN ALTERNATIVES**

As it indicated in Appendix C, KOPeR-lite identifies three areas that exhibit process pathologies. These are parallelism, process friction (due to a high activity to handoff ratio), and the process friction generated by excessive feedback loops (checking and complexity in KOPeR-lite terms).

With regard to parallelism, each activity is dependent on the output of the activity preceding it. Therefore, no recommendations are provided for process delinearization. The focus of the redesigns proposed below, therefore, will be on reducing process friction and increasing IT automation.

The focus of the first redesign is to propose changes requiring minimal capital outlays, but still yield positive results. A more "radical redesign" is proposed in the second alternative. The costs of implementing some of the recommendations could prove prohibitive, but the resulting impact will be far greater than what could be achieved by implementing the recommendations made in the first alternative.

### **1. Redesign Alternative #1**

One of major areas of dissatisfaction from the mover's standpoint is the small amount of influence he or she has over their next assignment. This is due, in part, to the amount of information made available to the mover with

regard to current and projected billet vacancies. To solve this problem, one recommendation would be that information about current and projected billet vacancies used by the monitors be made available to movers. This information could be made available by posting it to a website. Movers would continue to communicate their desires using the same communication channels present in the baseline process.

Empowering monitors to issue orders without explicit supervisory approval could reduce process friction. Proposed orders could be issued to supervisors where they would be given a certain amount of time to review them. During this review period, supervisors would have the opportunity to request a modification to the proposal. Once the review period elapses, the monitor would be allowed to disseminate the orders without further adieu.

Other problems relate to the order issuance activity. These stem from the numerous methods used to disseminate PCS orders to officers. Since only one method, AWOPS, automatically updates the information contained in MCTFS, it is recommended that orders only be issued using this method. This will result in MCTFS containing more accurate, timely information, which will ultimately provide planners with better information to use during the planning phase of the orders process.

The figure below outlines the changes proposed above:

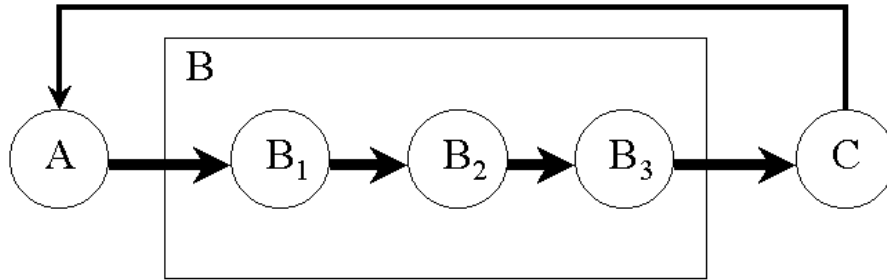

ACTIVITIES							
		A	B	B <sub>1</sub>	B <sub>2</sub>	B <sub>3</sub>	C
ATTRIBUTES	O:	Planning	Personnel/Career Management	Mover and Billet Vacancy ID	Mapping of Mover to Billet	Order Approval	Orders issuance
	A:	Planners		Monitor	Monitor	Monitor's Supervisor	Monitor
	S:	<ul style="list-style-type: none"> <li>• T/O dB</li> <li>• PMR*</li> <li>• MCTFS</li> </ul>		<ul style="list-style-type: none"> <li>• S/G model</li> <li>• web-base billet vacancy listing</li> <li>• word processor</li> <li>• MCTFS</li> </ul>	<ul style="list-style-type: none"> <li>• stand-alone dB or spreadsheet</li> <li>• e-mail</li> <li>• Word processor</li> </ul>	<ul style="list-style-type: none"> <li>• word processor</li> <li>• e-mail</li> </ul>	<ul style="list-style-type: none"> <li>• AWOP</li> <li>• MCTFS</li> </ul>
	C:	<ul style="list-style-type: none"> <li>• PMR*</li> </ul>		<ul style="list-style-type: none"> <li>• PMR</li> </ul>	<ul style="list-style-type: none"> <li>• telephone</li> <li>• FAX</li> </ul>	<ul style="list-style-type: none"> <li>• telephone</li> <li>• FAX</li> </ul>	<ul style="list-style-type: none"> <li>• telephone</li> <li>• FAX</li> </ul>

\* The PMR is software tool that generates a report having the same name.

Size	5
Length	5
Handoffs	4
Feedback Loops	1

IT support	11
IT communication	3
IT automation	1

Figure 4-2. Alternative #1 Modified PCS Orders Process

## 2. Redesign Alternative #2

As was recommended in the first alternative, movers should be given access to information about current and projected billet vacancies. This could be accomplished by making this information available on a website. Movers could then input their billet preferences in an online form. A message would be automatically sent to the appropriate monitors who could then use this information to assign the officer to a billet that most closely matches

the mover's professional and personal needs/desires. This should result in greater satisfaction on the part of the mover once he or she receives orders and should eliminate the feedback loop between the "orders issuance" and "mapping of mover to billet" activities in all but exceptional cases.

In terms of IT automation, a system could be developed whereby orders are automatically issued once the supervisor approves the PCS order proposals submitted by monitors. For instance, the proposal could be forwarded to the supervisor using a groupware application like LotusNotes. Once approved, a middleware application could then transfer the information contained in LotusNote to AWOPS so that orders can be generated and MCTFS updated. This would be a significant improvement over the baseline process since one feedback loop would be eliminated and a manual orders generation process would be eliminated. This would both decrease process friction and increase process efficiency.

An alternative method for decreasing the friction present would be to empower the monitors. The first alternative still involves submitting proposed orders to supervisors for review. Perhaps a study should be conducted to determine if this review activity offers any added value. If there is no value added, the review activity should be eliminated. This would decrease process friction both in terms of handoffs and feedback loops.

Additionally, a single means of orders dissemination should be used. Instead of receiving orders in any of the six methods used in the baseline process, one standard method should be adopted, such as the AWOP system. The key

point here being that the method used should generate automatic system updates so that the information contained in MCTFS is accurate (which will result in a more accurate PMR).

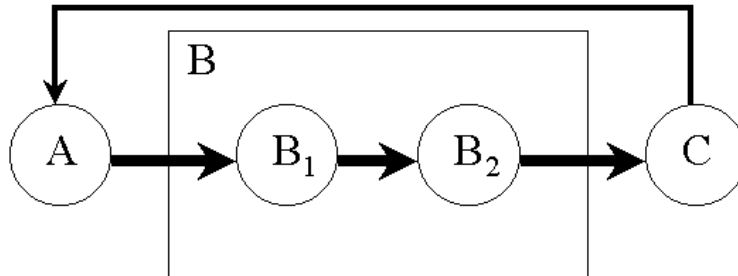

		ACTIVITIES				
		A	B	B <sub>1</sub>	B <sub>2</sub>	C
ATTRIBUTES	O:	Planning	Personnel/Career Management	Mover and Billet Vacancy ID	Mapping of Mover to Billet	Orders issuance
	A:	Planners		Monitor	Monitor	Monitor
	S:	<ul style="list-style-type: none"> <li>• T/O dB</li> <li>• PMR*</li> <li>• MCTFS</li> </ul>		<ul style="list-style-type: none"> <li>• S/G model</li> <li>• web-base billet vacancy listing and integrated billet preference input form to facilitate monitor-mover communications</li> <li>• MCTFS</li> </ul>	<ul style="list-style-type: none"> <li>• groupware application which facilitates the orders issuance activity</li> </ul>	<ul style="list-style-type: none"> <li>• AWOP</li> <li>• MCTFS</li> </ul>
	C:	<ul style="list-style-type: none"> <li>• PMR*</li> </ul>		<ul style="list-style-type: none"> <li>• PMR</li> </ul>	<ul style="list-style-type: none"> <li>• telephone</li> <li>• FAX</li> </ul>	<ul style="list-style-type: none"> <li>• telephone</li> <li>• FAX</li> </ul>

\* The PMR is software tool that generates a report having the same name.

Size	4
Length	4
Handoffs	3
Feedback Loops	1

IT support	7
IT communication	3
IT automation	3

Figure 4-3. Alternative #2 Modified PCS Orders Process  
Note the elimination of the supervisory review activity

THIS PAGE INTENTIONALLY LEFT BLANK



## V. SUMMARY, CONCLUSIONS, AND FUTURE RESEARCH

### A. SUMMARY

This thesis showed, through a process of statistical analysis and qualitative assessment, the viability of using automated tools, such as KOPeR-lite, when undertaking process reengineering projects. Additionally, reengineering solutions for the permanent change of station orders process for USMC officers were developed using a combination of the recommendations generated by KOPeR-lite and personal insight. These redesigns will be made available to the leadership in the Headquarter, U.S. Marine Corps (HQMC) Manpower and Reserve Affairs (M&RA) branch for review and possible adaptation as this branch moves to implement the Defense Integrated Military Human Resource System (DIMHRS). One of the proposed solutions may dramatically improve process performance.

Chapter I establishes the need for research and outlines the questions to be answered. Chapter II provides a brief historical outline of process reengineering and why it is pursued. Additionally, the Davenport framework is presented along with a functional description of KOPeR-lite. KOPeR-lite is used to depict processes and gain an understanding for redesign. Chapter III covers the experimental design, data, analysis, results and implications. Chapter IV addresses the matter of reengineering the permanent change of station (PCS) orders process for USMC officers. It provides a description of the fundamental baseline process, recommendations generated by KOPeR-lite for process redesign, as well as proposed

process redesigns developed using the KOPeR-lite's recommendations as a point of departure. Chapter V provides conclusions, recommendations and topics for further research, which are presented below.

## **B. CONCLUSIONS**

Redesigns generated by BPR novices who use KOPeR-lite to aide them in their reengineering efforts are superior in terms of process enablers (IT and non-IT), reduced process friction through a reduction in handoffs, and redesign clarity to those produced by novices working alone. This statement is supported by the analysis discussed in Chapter III.

In light of the benefit KOPeR-lite provides, a new process was selected for modification; the permanent change of station orders process for USMC officers. This process was analyzed in much the same way as the process contained in Appendix A. The metrics were inputted into KOPeR-lite and the resulting redesign recommendations were used as a point of departure for the redesigns proposed in Chapter IV. Subsequent analysis of these redesigns using KOPeR-lite show that each of the proposed alternatives solve some of the pathologies associated with the baseline process. Each of the alternatives has been analyzed by KOPeR-lite and the results it its analysis are contained in Appendix C.

## **C. RECOMMENDATIONS**

Individuals who are tasked with reengineering business process who have little or no experience in the field of

BPR, should consider using KOPeR-lite or a similar tool to assist them. The recommendations such tools generate provide an excellent foundation on which they can develop process redesigns.

Additionally, HQMC, M&RA should take steps to modify the current processes followed for managing the officer corps in general and the PCS orders process specifically. The ideas that compose the alternatives proposed in Chapter IV should be considered for incorporation when this process is redesigned.

#### **D. FUTURE RESEARCH**

KOPeR-lite in its current form, is only designed to assist in reengineering knowledge-based processes. Therefore, one area which warrants additional is to expand the rule set employed by KOPeR-lite so that it can provide redesign recommendations for process belonging to other domains.

A more rigorous statistical analysis should be conducted on the data collected from this initial experiment.

Additional experiments should be conducted which build upon the one analyzed in Chapter III. Follow-on experiments should focus on expanding the pool of experimental subjects. Included in this pool of experimental subjects should be working professionals outside the military. Subjects should also represent a broader range of educational backgrounds. By expanding the pool of subjects, the results of subsequent statistical

analyses can be more easily generalized to the population at large.

## APPENDIX A. DR. MARK'S SOFTWARE DEVELOPMENT CASE<sup>19</sup>

This minicase centers around a generic software development process, the baseline of which is described below. First a narrative description of the case is provided. This is followed by a high-level process model used to obtain measurements. The measurements can be used in turn for KOPeR analysis.

### A. BASELINE PROCESS

A major service provider has a separate organizational unit that is responsible for the development of large software applications. Software development represents a key sub process in support of both front- and back-office operations, as the ability to seamlessly integrate marketing and sales with order fulfillment and product support represents a strong selling point for the company. However, customer feedback has suggested that the process has a number of shortcomings and flaws, particularly with respect to the long cycle time required to prepare a software application and the inability to report on the status of a particular package while it is being processed. A closer examination of the process flow activities should help elucidate some of these shortcomings and flaws.

The process involves three Value Stream participants:

---

<sup>19</sup> This mini case was written by [Professor Mark Nissen \(http://web.nps.navy.mil/~menissen\)](http://web.nps.navy.mil/~menissen), initially for his Electronic Commerce course at UC Berkeley, and is now used in a number of graduate courses at the Naval Postgraduate School. It represents an amalgamation of many software development processes, as opposed to any one particular case, with the express purpose of promoting class discussion about process redesign. This mini case may be used for instructional purposes without fee, but must be cited in any academic works.

- 1) Field Sales groups with representatives that work to identify new customer requirements,
- 2) the software development organization, and
- 3) a third party software validation company.

The software development organization is organized in terms of four functional departments, each of which is staffed with specialists for the functional areas:

- 1) requirements,
- 2) design,
- 3) coding, and
- 4) test.

A process representation is presented below.

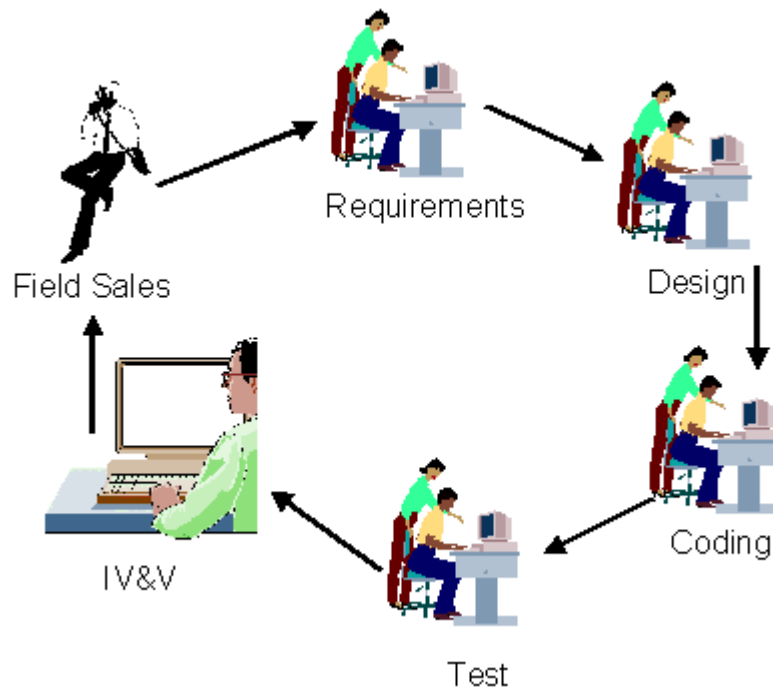

From the figure you can observe that the process flow is sequential, beginning with a telephone call from the field sales representative to the requirements manager in the software unit. This functional manager writes the customer-requirements information on a piece of paper and assigns the job to a requirements specialist from the

department. This assignment is accomplished simply by placing the paper in the specialist's in-box. The requirements specialist retrieves the paper from his or her in-box, and begins to integrate the requirements of the potential customer into the functionality of the firm's existing software. This integration is accomplished manually, but the agent creates a requirements document using a word processing application on a standalone computer terminal in the specialist's office.

Once the requirements specialist completes the requirements document, he or she reviews the results with the department manager. Upon approval, the paperwork is then mailed to the Design Department, where another functional manager will assign a design specialist to work on the job. The design specialist in turn will retrieve the requirements document from an in-box and design the software using a CASE tool on a standalone workstation in the specialist's office. Once developed, the logical design is reviewed with the design manager. Upon approval, the design documentation is printed and mailed to the Coding Department, where another functional manager similarly assigns the job to a coding specialist and places the paperwork in the appropriate in-box.

The coding specialist is responsible for implementing the software through programming code. A rapid application development (RAD) tool suite is used to develop the software code, which tool suite resides on a desktop workstation in the specialist's office. The code is compiled and debugged, copied to disk and mailed to the Test Department. As in the departments above, a functional

manager in Test assigns a test specialist to execute the software code under a number of various test scenarios. When complete, the test results are reviewed by the functional manager and then sent along with the software code to an independent verification and validation (IV&V) firm, generally via overnight air service. Once received, the IV&V representatives verify the results of each step in the software development process and validate the end product satisfies the original requirements outlined by the field sales agent. The IV&V results are in turn forwarded to Field Sales, provided the software checks-out OK.

It important to note, at each stage of the process, some manner of quality assurance is performed, and work products (e.g., requirements documents, software designs, compiled code) not up to standards are returned to the originating department for rework. In the case of the IV&V step, work can be returned back to any of the four functional departments associated with the software development. The cycle time for this process is generally between one and two months for a relatively straightforward software implementation.

## **B. PROCESS MODEL**

The baseline software development process can also be represented in terms of a graphical model such as the one below. It includes the key process activities, attributes and measurements. Specifically, the six primary activities from above are included as nodes in this graph-based representation--1) Sales needs identification, 2) requirements development, 3) software design, 4) coding, 5) test, and 6) IV&V. Each activity node is linked to its



predecessor(s) and successor(s) through directed edges and is defined in terms of four attributes shown.

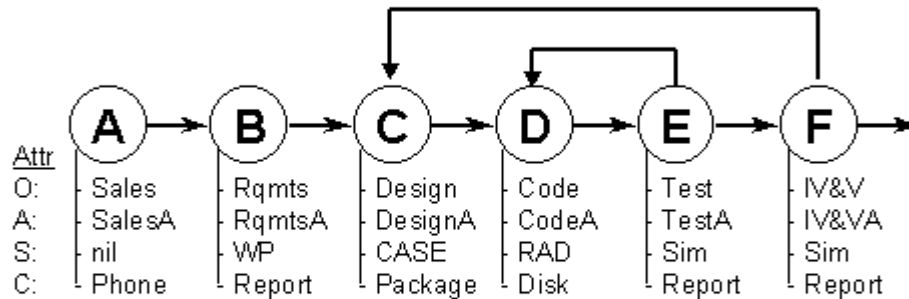

- "O" designates the performing organization in the process (e.g., Sales Department, Requirements Department)
- "A" designates the agent role in the process (e.g., Sales Agent, Requirements Agent)
- "S" designates the information technology employed for support in the process (e.g., word processor (WP), computer-aided software engineering (CASE) tool)
- "C" designates the media/technology employed for communication in the process (e.g., phone, report)

Graph-based counting rules are used to obtain measurements for the process. For instance, process size (6) represents the number of activity nodes in the process and process length (6) is measured as the longest path

through the process. Notice the two feedback loops in the diagram (e.g., from test back to coding and from IV&V back to design. They are counted (2) as are the five handoffs of work from agents performing in different roles (e.g., from the Sales Agent to the Requirements Agent). The WP, CASE, RAD and simulation (sim) tools are counted in the IT-support total (5), but phone- and paper-based communications do not contribute toward the IT-communication count. These measurements should suffice to provide KOPeR input for measurement-driven inference.

## APPENDIX B. EXPERIMENTAL CASE DATA

A table of explanations for assignment of quantitative assessments of the students' proposed redesigns are provided in the following pages.

For each redesign, three passes are made to evaluate the criteria laid out in chapter III par A. The first pass was made by the author and is annotated in BLACK. The second pass was made by Professor Nissen and is annotated in RED. The third and final pass represents and integration of the two analysts' finding and is annotated in BLUE. The results of this third pass are what was used to populate the spreadsheet contained in par 2 below.

### A. WITHOUT KOPER-LITE

Subject #	Redesign #	Quality					Clarity	Impact
		Delinearization	enablers	non-value added items removed	change in # of feedback loops	change in # of hand-offs		
Subject #1	1	Y: Combined req and design	0	0	0	-1: With creation of Req/design team, one handoff is eliminated	3	1: Design/Req combo w/o IT enablers will probably result in minimal improvements
		N: still sequential	same PLUS OD: job enlargement	same	same	same	same	same
		N	OD: job enhancement	0	0	-1	3	1
	2	N	4: email, workflow s/w (i.e. Lotus Notes), CASE tools, computer network	0	0	0	3	2: IT enabled comm. Between activities will produce noticeable improvements; however, IT alone will not result in optimal results
		same	same	same	same	same	same	same
		N	4: email, workflow s/w (i.e. Lotus Notes), CASE tools, computer network	0	0	0	3	2

	3 (combo of 1&2)	Y	4	0	0	-1	3	3: IT enablers combine with OD changes and reduced feedback loops will result in significant improvements
		N	same PLUS OD	same	same	same	same	same
		N	4 PLUS OD	0	0	-1	3	3
Subject #2	1	N	2: Network, email	0	0	0	2	1: Simply providing for paperless communication is not enough to realize significant improvements
		Same	Same	Same	Same	Same	1: no diagram	same
		N	2: Network, email	0	0	0	1	1
	2	N	4: Email, conference call, FTP, network	0	0	0 same	2	1: Additional IT enablers have been introduced, but there is still no mention of how to change work processes to fully realize the benefits the IT enablers could afford
		Same	Same	inbox	Same	Same	1: no separation or redesigns	same
		N	4: Email, conference call, FTP, network	0	0	0	1	1
Subject #3	1	N	4: email, ftp, network, internet	0	0	0	2	1: introduction of IT enablers is not sufficient to bring about significant improvement
		same	Same	same	same	same	1: no diagram	same
		N	4: email, ftp, network, internet	0	0	0	1	1
	2	N	4: Conference call, email, ftp, network	0	0	0	2	1: introduction of IT enablers and automating "as is" processes are not sufficient to bring about significant improvement. Processes should be changed to take advantage of the full potential of IT enablers
		same	same	inbox	same	same	1: no separation of redesigns	same

		N	4: Conference call, email, ftp, network	0	0	0	1	1
Subject #4	1	N	3: network, email, workflow s/w	0	0	0	2	1: IT alone w/ no matching process changes
		same	Same	same	same	same	same: diagrams and spe buy unclear	same
		N	3: network, email, workflow s/w	0	0	0	2	1
	2	Y: create requirements, Design, Code, Test team w/ team manager	3: network, email, workflow s/w. Enablers from redesign #1 included based on his comment, "If we assume that the earlier suggested infrastructure are in place..."	0	-3: from 5 to 2	-6: from 9 to 3	2	3: IT enablers are combined with OD and process changes to increase efficiency
		N; still sequential	same PLUS OD: case team	same	same	same	same	same
		N	3: network, email, workflow s/w OD: case team	0	-3	-6	2	3
	3	N: but includes creation of a case mgr	0: no comment about enablers is made	0	0: same as baseline w/ 5	-3: from 9 to 6	2	2: IT enablers and case manager are used but no mention of process changes. The case manager will increase awareness of where things are in the development process. Without the case manager, I would have assigned a "1" for impact.
		same	same PLUS OD: case mgr	same	same	same	same	same
		N	OD: case mgr	0	0	-3	2	2

Subject #5	1	Y: Combined Design, code, test team	7: Web-DBMS, Intranet, DSS for req rpts, Design/Test/Code application (i.e. from Oracle), group ware, ES for simulation, FTP	1: elimination of Req via use of a DSS to build a "req rpt". Could list "2" as # of NVA eliminated as the comments about the elimination of IV&V with the use of an ES to "perform simulation testing.", but then includes IV&V in the tabular depiction of the redesign,	-2: 2 to 0; with integrated team, no need for explicit feedback loops	-4: from 5 to 1	2	3: significant use of IT enablers and formation of an integrated development team under one manager promises significant process improvements
		N; still sequential	same PLUS OD: case mgr	same	same	same	same: diagram, sep, but unclear	same
		N	7: Web-DBMS, Intranet, DSS for req rpts, Design/Test/Code application (i.e. from Oracle), group ware, ES for simulation, FTP OD: case mgr	-1	-2	-4	2	3
	2	Y: Code and test combined under one functional mgr	6: DBMS, DSS, Intranet, ES, Design/Code/Test S/W app (i.e. Oracle), group ware	1: elimination of Req via use of a DSS to build a "req rpt".	0: 2 feedback loops are retained though they are different than those included in the baseline design: feedback IV&V to Dev Mgr and from Dev Mgr to Sales	-3: from 5 to 2 (Sales to Dev mgr and Dev Mgr to IV&V)	2	2: ample IT enablers and combination of Design/Code under one mgr w/ activities being carried out in parallel
		same	same	???	same	-1: 5→2	same	same
		Y	6 IT; 0 non IT	1	0	-3	2	2

Subject #6	1	Y: Combined Design/Code and Test/IV&V	0	0	-1: Feedback loops are not explicitly depicted or addressed, so I interpreted the increased parallelism in opt 1 as only reducing feedback loops by 1 as the Design/Code and Test/Validate functions will have a feedback loop. In opt 3, a case manager is used, which implies more or less continuous feedback.	-2: From 5 to 3	1	1: parallel processes without IT enablers to speed things up with result in minimal process efficiency/effectiveness gains
		N: still sequential (reading works, no observing a digraph)	OD: case mgr	same	same	same	same: diagram doesn't match description no separation of redesigns	same
		Y	OD: case mgr	0	-1	-2	1	1
	2	?: not addressed in this redesign	3: Network, email, database	0	-2: no feedback loops depicted in redesign (from 2 to 0)	?: not addressed in this redesign	1	1: IT enablers without other supporting changes will result in minimal improvements
		N	Same	same	0: 2→2	0	same	same
		N	3 T; 0 non IT	0	-2	0	1	1
	3	?: not addressed in this redesign; mention of a project mgr, but details not discussed	0	0	-2: no feedback loops depicted in redesign (from 2 to 0)	?: not addressed in this redesign	1	1: introduction of product manager a good initial step to increase overall work flow analysis, but no changes in IT enablers or work flow will result in little change and maybe the perception of micromanagement)
		N	OD: PM OD: team MC: culture	1; PM ?	-1: 2→1 (PM)	0	same	same
		N	0 IT; 3 non IT	0	-3	0	1	1
Subject #7	1	N	3: distributed databases, CASE tool	0	0	-1	2	1: IT with no other enablers and no change in processes will result in minimal improvements

		Y: reqs	same PLUS WF: delin	same	same	0	1: no diagram	same
		Y	3:IT; 1 non IT	0	0	0	1	1
	2	Y: combine Req/Design and Code/Test	0	0	-1: from 2 to 1 with the combination of Code/Test	-2: from 5 to 3	2	1: Merging activities with no introduction of IT or non-IT enablers will produce little more than a cosmetic change
		N: no mention of delin No statement that trans or cumulative	IT: email IT: network	same	0: 2→2	0: 5→5	1: no separation of redesigns	same
		N	2 IT; 0 non-IT	0	0	0	1	1
	3	N	2 : email, FTP	0	0	0	2	1
		same	same	-1: reqs	same	-1: 5→4	1: diagram but unclear	same
		N	2 IT; 0 non IT	1	0	0	1	1
Subject #8	1	Y: Req/Design activities combined	3 ; email, internet, FTP .	0	1: addition of customer feedback loop	0: though Req/Design combined, addition of customer in the model offsets the handoff reduction	2	3: Integration of IT and non-IT enablers, change in processes, and elimination of physical separation of activities together promise to increase information exchange, reduce friction, and facilitate more rapid S/W development efforts
		N: still sequential	same PLUS WF: add customer OD: combine depts	same	+2: 2→4	same	same: diagram, separation, but unclear	same
		N	3 IT; 2 non IT	0	2	0	2	3
	2	Y: Req/Design activities combined	4 ; email, internet, FTP, organizational Knowledge- Based system	0	9: This increase is due to the incorporation of an automated knowledge base into which each activity is linked	0: (same as above)	2	2: Though the KB may eventually prove as effective, I believe there is a lot to be said for face to face interaction in a "creative" endeavor like S/W development
		Same	same PLUS WF: add customer OD: combine depts	same	+4	+3: 5→8	same: diagram, separation	same
		N	4 IT; 2 non IT	0	2	0	2	2



Subject #9	1	N	2: distributed database, network	0	0	0	2	1: IT w/ no process change
		Same	same PLUS IT: CASE	same	same	same	1: no diagram, sep	same
		N	2 IT	0	0	0	1	1
	2	Y: Combine Req/Design activities and Code/Test activities	0	0	-1: from 2 to 1 with merger of Code/Test activities	-2: from 5 to 3	2	1: Integration of activities with no change to old ways of doing business or use of any enablers
		N	OD: combine 4 depts	same	same	same	1	same
		N	0 IT; 1 non IT	0	-1	-2	1	1
	3	N	1: email	0	0	0	2	1: simply automating a single step without looks for other ways to benefit from IT enablers limits impact
		Same	Same	reqs	Same	Same	1	same
		N	1 IT; 0 non IT	0	0	0	1	1
Subject #10	1	N: however, she proposes using a case manager to reduce friction between activities and maintain project status awareness	8: email, database, LAN, workflow S/W, DSS for employee selection, internet, RAD to capture reqs and generate S/W prototype, Lotus Notes	-2: elimination of Code activity with use of Visible Analyst to generate code automatically, and the elimination of IV&V in "phase 2" of her redesign	1: addition of customer feedback loop	-2: from 5 to 3 w/ elimination of Code and IV&V activities	1	3: Though I believe some of her assumptions to be flawed (i.e. Coding can be entirely through automation), her extensive use of IT and non IT enablers, case manager, and process changes to capitalize on benefits afforded by IT enablers promise significant improvement
		Y: sales and cust	same PLUS: IT: web OD: case mgr IT: visible analysts	same	same	0: 5→5	same: diagram, but unclear	same
		N	10 IT; 1 non IT	-2	1	-2	1	3
Subject #11	1	Y: combine Code/Test activities; Test and IV&V done simultaneously; use of case mgr	2: centralized database, email	0	2: from 5 to 7 - feedback between all activities and case manager will be required.	-1: from 5 to 4 with integration of Code/Test	2	2: combining Design/Code activities into an integrated team and having Test/IV&V done simultaneously in conjunction with the use of a case manager coupled with IT enablers such as email and shared databases promise significant improvements

		same	Same PLUS 3: ???	same	same	same	same	same
		y	2 IT; 3 non IT	0	2	-1	2	2
	2	Y: combine sales/reqs, Code/Test, and Test and IV&V done simultaneously	2: centralized database, email	0	1: from 5 to 6 - feedback between all activities and case manager will be required.	-2: from 5 to 3 with integration of Code/Test and Sales/Req	2	3: a further enhancement of his first redesign which results in less friction and additional job enrichment
		same	Same PLUS 3: ???	same	same	same	same	same
		y	2 IT; 3 non IT	0	1	-2	2	3
Subject #12	1	N	3: LAN, database, email	0	Unable to determine from analysis	Unable to determine from analysis	1	1: Use of IT enablers alone will not produce the process improvements sought
		same	same	same	0	0	same	same
		n	3	0	0	0	0	1
	2	Y: Combine Req/Design activities and Code/Test activities	2: LAN, VTC	0	Unable to determine from analysis	Unable to determine from analysis	1	1: minimal use of IT enablers and lack of process change beyond just combining activities, limits the impact of this redesign
		same	Same PLUS ???	same	-1	-1	same	same
		No	2 IT; 1 non IT	0	-1	-1	1	1
Subject #13	1	Y: states "combine requirements and design" and then depicts Sales using a CASE to develop the Reqs, so it appears as though he's actually combined Sales/Req/Design	4: CASE and WP for Sales, email, S/W to convert CASE developed Req Doc into a design and coding doc	0	0: he depicts a reduction from 2 to 1, but he eliminates the feedback loop between IV&V and design which doesn't make sense as without this feedback loop, the "final rpt" IV&V develops would not be returned to the S/W dev company	-2: from 5-3 with combination of Sales/Req/Design activities	2	2: Use of IT enablers along with work flow redesign (i.e integrating Req/Design) promises moderate improvements
		N: still sequential	same PLUS OD: combine depts	same	same	same	same: diagram, sep of redesigns, but unclear	same
		N	4 IT; 1 non IT	0	0	-2	2	2

	2	Y: same as redesign #1 plus making test/IV&V parallel processes	1: intranet	0	0: see comments in redesign #1	-2: from 5 to 3 with combination of Sales/Req/Design. Design has to had off to both IV&V and Testing so no further reduction in handoffs is realized with this change.	2	2: Same as above but Test/IV&V done in parallel and use of internet to post documents. Offers some additional gains over the first redesign, but not significant enough to warrant a "3" in my mind
		Y: Test/IV&V	same PLUS WF: delin	same	same	same	same	same
		Y	1 IT; 1 non IT	0	0	-2	2	2
Subject #14	1	Y: combined Sales/Req activities and make Sale a Case Manager	3: computer network, central database, CASE tool on net that spts all phases of the D/W devel process	0	4: from 2 to 6 with inclusion of Case Manager	-1: from 5 to 4 with combination of Sales/Req	2	3: attention given to reworking processes to take full advantage of organizational redesign and incorporation of IT enablers along with the use of a case manager promises significant impact
		Y: design/code	same PLUS OD: case mgr OD: combine sales/reqs	same	-2: 2→0	same	same: diagram, but unclear	same
		N	3 IT; 2 non IT	0	4	-1	2	3
Subject #15	1	N: but does include a Case Manager	1: electronic forwarding of S/W by phase to IV&V by case Mgr	0	3: from 2 to 5 with inclusion of Case Mgr feedback loops between CM and each development activity as well as a feedback loop from IV&V to the CM must be present, though he graphically depicts only a single feedback loop from IV&V to the CM	2: from 5 to 7 - Sales to CM, CM to Req, Req to Design, Design to Code, Code to Test, Test to CM, CM to IV&V; he shows only 3 handoffs, but I believe his analysis to be inaccurate.	-1	2: use of case manager and reorganizing Req/Design/Code/Test facilitate communication and information sharing. IT enablers are also used to reduce friction and increase the Case Mgr's situational awareness. Phased development should also limit the amount of rework.
		Same	same PLUS OD: case mgr	-1 (added case mgr step)	Same	Same	2: diagram, separation, unclear	same
		N	1 IT; 1 non IT	0	3	2	1	2

	2	N	2: email, central database	0	2: from 2 to 4 with inclusion of central database which must be referenced by each activity for changes or feedback from IV&V	-2: from 5 to 3 as Design, Code, Test, IV&V activities will no longer explicitly forward deliverables, but will rather post them to the central database	1	2: Shared database will reduce friction, increase information sharing, and has the potential to reduce rework with IV&V being more involved from the beginning, but lack of other process modification (i.e. activity integration, inclusion of case manager) limits the potential impact
		Same	Same	Same	3: 2→5	Same	2: diagram, separation, unclear	same
		N	2 IT; 0 non IT	0	2	-2	1	2
Subject #16	1	N	4: Network, CASE used network wide, Groupware for info sharing, matrix database	0	0: he recommends using a spiral development cycle and developing modules w/ each iteration of the cycle vice designing, coding, test and doing IV&V on an entire application	2: from 2 to 4 with inclusion of networked CASE tool which will need to be referenced by each activity for change and updates	1	3: Redesign makes adequate use of IT enablers and develops some workflow modifications such as adopting a spiral development cycle and an IPT-type concept
		Y: design/code/test	same PLUS WF: delin WF: spiral dev OD: mgmt team	same	same	2: 5→7	same	same
		Y	4 IT; 2 non IT	0	0	2	1	3
Subject #17	1	Y (parallelism in the software-development activity)	5: email, intranet, internet, application generator, CASE tool	1? (coding replaced by code generator?) - this may just be automation 0	-4 (6 total reduced to 2)	-5 (9 total reduced to 4, excludes handoffs associated with feedback/rework)	2 (OK, but somewhat difficult to trace redesigns to enablers)	3: Changes from waterfall to evolutionary development process using IT enablers and an integrated S/W development group. Also plans for code reuse
		Same	same PLUS WF: evolutionary dev WF: code reuse	0	-3: 5→2	-8: 17→9	same	same
		Y	5 IT; 2 non IT	0	-4	-5	2	3

	2	Y (parallelism in the software-development activity)	5: email, intranet, internet, application generator, CASE tool	1? (coding replaced by code generator?) - this may just be automation	-4 (6 total reduced to 2) same	-5 (9 total reduced to 4, excludes handoffs associated with feedback/rework) same	2 (OK, but somewhat difficult to trace redesigns to enablers) same	3: negligible improvement over first redesign (this is an enhancement of the first redesign)
		Same	same PLUS WF: evolutionary dev WF: code reuse	same: IV&V eliminated	Same	Same	Same	same
		Y	5 IT; 3 non IT	1	-4	-5	2	3
Subject #18	1	Y: Sales/Reqs activities combined as Design/Code/Test	2: email, trouble ticket S/W	0	0: no change	-3: from 5 to 2 with merging of Sales/Req and Design/Code/Test activities	2	2: Makes use of modular development practices, integrated development activities, and adequate IT enablers to facilitate communication and S/W development. Lacks use of a case manager to maintain oversight, though Sales is now able to track S/W through process
		Same	same PLUS WF: delin	Same	Same	0	same: no diagram	same
		Y	2 IT; 1 non IT	0	0	-3	2	2
	2	Y: Sales/Req activities combined as Test/IV&V	2: email, trouble ticket software,	0	-1: with combination of Test/IV&V only feedback from this combined activity to Design would remain	-2: from 5 to 3 with combining of Sales/Req activities and Test/IV&V activities	2	2: limited use of IT enablers and limited process change to take advantage of enablers, though gains are made by having Test/IV&V done in parallel.
		Same	same PLUS OD: delin	Same	Same	0	same: no diagram	same
		Y	2 IT; 1 non IT	0	-1	-2	2	2
	3	N	0	-1: elimination of internal Test activity and outsource all testing to external IV&V activity	-1: w/ elimination of internal Test activity, only feedback from IV&V to Design would remain	-1: from 5 to 4 with elimination of internal Test activity	2	1: IV&V activity is eliminated but no mention of any other IT or non-IT enablers or other workflow changes/enhancements
		Same	outsource	Same	Same	Same	Same	same
		N	0 IT; 1 non IT	-1	-1	-1	2	1

Subject #19	1	Y: combine Req/Design/Code/Test by using IPTs	7: network (wire or wireless), CASE tools, central database, RAD, JAD, shared resource files, personal computers	0	-1: from 2 to 1 with the creation of IPT's. Feedback from IV&V and Sales	-3: from 5 to 2 with creation of IPTs	2	3: extensive use of IT enablers, formation of integrated development team (i.e. ITP) with manager oversight
		N: still sequential	same PLUX OD: IPT	same	same	same	1	same
		N	7 IT; 1 non IT	0	-1	-3	2	3
Subject #20	1	Y: creation of IPTs composed of Req/Design/Code/Test activity specialists	5: Internet, intranet, network tools (i.e. email), high and low level CASE tools (i.e Oracle)	0	-2: from 3 to 1	-10: from 18 to 8	1	2: Good integration of IT enablers and implementation of case manager concept, but no discussion of changing underlying processes to take better advantage of IT enablers
		N	same PLUS OD: case mgr	same	0: 1→1	-4: 5→1	2: diagram, separation, unclear	same
		N	5 IT; 1 noN IT	0	-2	-10	1	2
	2	Y: creation of IPTs composed of Req/Design/Code/Test activity specialists	5: internet (for customer requests), intranet, network tools (i.e. email), high and low level CASE tools (i.e Oracle)	-1: eliminate sales rep	-2: from 3 to 1	-11: from 18 to 7 with elimination of sales activity	1	2: Pretty much the same as redesign #1 but eliminates an activities and makes more use of intranet. Still not significant enough to rate a 3
		N	same PLUS IT: loan processing s/w IT: network OD: dombine sales/credit	0	0	-1: 5→4	2: diagram, separation, unclear	same
		N	5 IT: 0 non IT	0	-1	-11	1	2

Subject #21	1	N	3: personal computers, email, network	0	3: from 2 to 5 with creation of case mgr and feedback to the CM by each activity internal to the S/W Development division	0: handoffs remain the same. Though he depicts an additional handoff between sales and the CM in his graphic representation, in my textual description of his redesign, he states that the CM tracks and the divisions hand off to one another	2	1: Moderate use of IT enablers but excessive reliance on case worker increases friction and I believe may actually result in development slowing
		same: still sequential	same PLUS OD: empowerment	0-4 mgrs	0	-3 9→6	3: diagram, separation	same
		N	3 IT; 1 noN IT	4	0	-3	2	1
	2	Y: creation of development teams (Req/Design/Code/Test)	3: personal computers, email, network	0	0: remains at 2	-2: from 5 to 3	2	2: Moderate use of IT enablers and development of Design Teams promises increased interaction between activities thereby reducing friction
		N: still sequential	same PLUS OD: design team	4: mgrs	-3: 5→2	-6: 9→3	3: diagram, separation	same
		N	3 IT; 1 non IT	4	-3	-6	3	2

**B. WITH KOPER-LITE**

Subject #	Redesign #	Delinearization	enablers	non-value added items removed	change in # of feedback loops	change in # of hand-offs	Clarity	Impact
Subject #22	1	N	4: DBMS, email, LAN, WAN	0	-1: elimination of feedback between internal Test and Code activities	0: remains unchanged from baseline process	3	1: minimal use of IT enablers, no org change
		same	same PLUS OD: 1 mgr OD: empowerment	manger review?	same	same	same	same
		N	4 IT: 2: non IT	0	-1	0	3	1
	2	N	LAN, case manager	0	0: unchanged (not addressed in redesign)	0: unchanged (not addressed in redesign)	1: diagram does not depict case manager involvement or feedback loops. Metrics are not provided for the second redesign	1: minimal use of IT enablers; case manager inserted, but roll not described; process changes not discussed
		same	Same	1	same	same	same	same
		n	1	1	0	0	0	1
Subject #23	1	Y: use of Design/Code/Test teams, use of Case Manager	8: email, EDI via online customer request form, shared database, expert system for requirements integration, network, LAN, VPN, use of internet	0	-1: from 2 to 1 with the elimination of feedback between Code and Test activities in light of the new "team" concept	-2: from 5 to 3	2	3: extensive use of IT enabler, organizational design altered and discussion of work process changes highlighted, inclusion of case manager and development team concept
		N: still sequential	same	manger review?	same	same	2: diagram, unclear	same
		N	8 IT: 0 non -IT	0	-1	-2	2	3
Subject #24	1	Y: integrated req/design/code/test team	4 : LAN, shared files, email, automated requirements generation tool	0	-4: from 5 to 1 with creation of integrated development team	-3: from 5 to 2 with creation of integrated development team	2	3: significant use of IT and non-IT enablers, case mgr, devel team, steps to reduce friction, facilitate comms
		N: still sequential	Same	same	same	same	1: hard to follow	same
		N	4 IT: 0non IT	0	-4	-3	2	3



Subject #25	1	Y: case manager for all but IV&V activities	0	0	0	-4: from 5 to 1 with incorporation of case manager	2: states that case manager will reduce number of handoffs, but I don't see that as being the case... increases situational awareness but info must still go from one activity to the next be it between activities or via the case manager	1: use of case manager will decrease friction but will not facilitate speed of communications in light of no IT enablers for comm
		N: still sequential	OD: case manager	0	0	-4	3: clear to me	same
		N	0 IT: 1 non IT	0	0	-4	3	1
	2	Y: case manager for all but IV&V activities	4: internet, intranet, shared database, LAN	0	0	-4: from 5 to 1 with incorporation of case manager	2: states that case manager will reduce number of handoffs, but I don't see that as being the case... increases situational awareness but info must still go from one activity to the next be it between activities or via the case manager	2: use of IT enablers in conjunction with case manager concept, however, this redesign seems to imply business is done the same basic way even though some steps are now digitized.
		N: still sequential	Same PLUS OD: case manager	0	0	-4	3	same
		N	4 IT: 1 non IT	0	0	-4	3	2
	3	Y: case manager for all but IV&V activities plus creation of Req/Design/Code team	4: internet, intranet, shared database, LAN	0	0	-4: from 5 to 1 with incorporation of case manager	2: states that case manager will reduce number of handoffs, but I don't see that as being the case... increases situational awareness but info must still go from one activity to the next be it between activities or via the case manager	3: extensive use of IT and non-IT enablers, case manager, development teams, work flow redesign
		N: still sequential Y: Rqts/Design/Code	Same PLUS OD: Case manager WF: delin OD: empowerment	0	0	0: 5 to 5	3	same

		Y	4 IT: 3 non IT	0	0	-3	3	3
Subject #26	1	N	6: server-based network, FTP, internet, webpage, email, expert system	-7: elimination of "mail" process accounts for 5 of these eliminated processes	0: remain same as baseline	-9: From 22 to 13; reduction mainly from elimination of forwarding output to follow-on activity via snail mail. Some handoffs considered frictionless since accomplished electronically	1: analysis not at "activity-level" but rather at process level. He shows an increase in enablers from 10 to 24 where I only show an increase of 6. I did not count each instance; each "tool" was counted once. Graphic depiction does not clearly show efficiency gains	2: moderate use of IT enablers to decrease comm. Delays, no work flow or process changes to compliment IT enablers.
		N	4: server-based network, FTP, , , , email, task assignment system	23→?	0	-6: 20→14	2: diagram, separate, but unclear	same
		N	6 IT: 0 non IT	-7	0	-9	2	2
	2	N	6: server-based network, FTP, internet, webpage, email, expert system	-10: elimination of mail processes plus automation of code generation account for these	-3: from 8 to 5	-16: from 22 to 6; reduction mainly from elimination of forwarding output to follow-on activity via snail mail. Increase in number of handoffs considered frictionless since accomplished electronically	1: analysis not at "activity-level" but rather at process level. He shows an increase in enablers from 10 to 24 where I only show an increase of 6. I did not count each instance; each "tool" was counted once. Graphic depiction does not clearly show efficiency gains	3: : change in work processes, activity automation (i.e. code generation), further reduction in handoffs
		N	6: server-based network, FTP, internet, email, expert system, code generator	-10	-4 (8→4)	-11 (20→9)	2: diagram, separate, but unclear	same
		N	7 IT: 0 non IT	-10	-4	-16	2	3
Subject #27	1	Y: combined Sales/Requirements consolidated all the various processes performed by individual "organizations" into single activities.	5: Group ware, workflow system, expert system, and implied are internet/intranet	-12: elimination of 13 processes and the addition of one new one.. the "customer advocate." Requirements process is greatly streamlined and snail mailing of outputs to follow-on activities eliminated with incorporation of additional IT-automation	-4: from 7 to 3; some feedback loops resulted from his analysis and breaking down activities into their component processes.	-12: from 17 to 5; this results I large part do to his consolidation of all the various processes performed by individual "organizations" into single activities.	1: by analyzing the base line processes at a finer degree of granularity, he artificially inflates the resulting efficiencies of his redesigns. Also, because of this, it is more difficult to compare his work to comparable redesigned by other students.	2: moderate use of It and non IT enablers (case manager)

		Y: B&C	4: Group ware, expert system, and implied are internet/intranet OD: customer advocate	-12: 19→7	-4	-12: 16→4	2: diagram, sep, unclear	same
		Y	5 IT; 1 non IT	-12	-4	-12	2	2
	2	Y: Development of Design/Code/Test teams	5: Group ware, workflow system, expert system, and implied are internet/intranet )	-13: elimination of 15 processes and the addition of two new ones.. the "customer advocate" and "form new product team." Requirements process is greatly streamlined and snail mailing of outputs to follow-on activities eliminated with incorporation of additional IT-automation	-6: from 7 to 1; however he doesn't consider the feedback that must happen with the inclusion of a "customer advocate" (aka case manager).	-13: from 17 to 4; again this results in large part do to this consolidation of all the various processes performed by individual "organizations" into single activities as well as the creation of the combined Design/Code/Test team.	1: by analyzing processes at a finer degree of granularity, he artificially inflates the resulting efficiencies of his redesigns. Also, because of this, it is more difficult to compare his work to comparable redesigned by other students.	3: moderate use of IT enablers coupled with non-it enablers like customer advocates and development teams expected to yield significant improvements
		Y: B&C	4: Group ware, expert system, and implied are internet/intranet OD: customer advocate OD: eliminate depts. (case team	-13	-6	-13: 16→3	2: same	same
		Y	5 IT: 2 non IT	-13	-6	-13	2	3
Subject #28	1	Y: inclusion of case manager concept and combination of Req/Design/Test/Code into a single activity falling under the case manager	1: email	0	-1: from 2 to 1	-3: from 5 to 2	2	2: minimal use of IT enablers, good use of non-IT enablers such as case mgr and development teams
		N: sequential	1: email OD: Case mgr	0	-1: 2→1	-3: from 5 →2	3: diagram, separate	same
		N	1 ITL 1 non IT	0	-1	-3	3	2

	2	N	3: LAN, email, FTP	0	8: From 2 to 10; resulting from all activities providing feedback to the LAN	4: From 5 to 9	1: depicting the LAN as an "activity" made the graphical depiction of his second redesign unclear. Additionally, none of the KOPeR output on the redesigns was provided so those could not be referenced to try and decipher what he was attempting to achieve.	2: moderate use of IT and other enablers but little attention paid to changing underlying work processes
		N	3: LAN, email, FTP	0	3: 2→5	4: From 5 →9	2: diagram, separate, unclear	same
		N	3 IT: 0 non IT	0	8	4	2	2
Subject #29	1	N	4: network, requirements input form, ability to import req info directly into CASE tool, electronically forwarding documents	0	1: from 2 to 3; this is based on the standard "as is" analysis as one was not provided with this paper. No graphic representation is provided, so these number were based on interpretation of his textual description.	0: remains unchanged from "as is" process	1: lack of "as is" analysis, graphic representations of redesigns, and/or KOPeR output made interpreting his redesigns difficult.	1: good use of IT enablers, but no change to underlying processes, no case manager, no team concept, no delin. Basically a digitized version of the baseline
		N	same	same	same	same	same	same
		N	4 IT: 0 non IT	0	1	0	1	1
	2	N	4: network, requirements input form, ability to import req info directly into CASE tool, transferring of read/write access controls between activities	0	1: from 2 to 3; this is based on the standard "as is" analysis as one was not provided with this paper. No graphic representation is provided, so these number were based on interpretation of his textual description.	0: remains unchanged from "as is" process	1: lack of "as is" analysis, graphic representations of redesigns, and/or KOPeR output made interpreting his redesigns difficult.	1: basically the same as redesign #1 with the additional burden or managing read/write permissions on shared files. No team or case manager concept. No delin.
		same	same	same	same	same	same	same
		N	4 IT: 0 non IT	0	1	0	1	1

Subject #30	1	Y: Design/Code/Test activities combined into a development team	3: online form, internet, intranet	0	-1: 2 to 1 w/ creation of Development Team	-2: from 5 to 3 w/ creation of development team	2: I had to assume he used the 6 activities, 5 handoff, 2 feedback loop baseline as he didn't cover this explicitly in his analysis	2: use of IT enablers to automate existing processes, integration of development team concept, but underlying processes remain largely unchanged
		N: still sequential	Same PLUS OD: combine des/code/test	same	same	same	same	same
		N	3 IT: 1 non IT	0	-1	-2	2	2
	2	Y: Design/Code combined as a single activity	5: website, online form, internet, intranet, email	-1: elimination of sales; customer submits requirements via the web	-1: from 2 to 1 w/ loop going from IV&V to Design	-2: from 5 to 3 with elimination of Sales and combination of Design/Code activities	2: (see above)	2: good use of IT comm. And IT support in Code activity. Elimination of Sales is not seen as an enhancement as many customers benefit from the give and take w/ a person when trying to clearly articulate their needs/reqs
		N	same	same	same	same	same	same
		N	5 IT: 0 non IT	-1	-1	-2	2	2
Subject #31	1	N	5: Internet/intranet, electronic form, email, automated requirements document development tool	0	0: no change from baseline	0: no change from baseline	2	2: moderate use of IT enablers but little change to underlying processes
		same	same	same	same	same	3: diagram, separate	same
		N	5 IT: 0 non IT	0	0	0	3	2
	2	Y: merging of Design/Code/Test team into an integrated team and use of a case manager	5: Internet/intranet, electronic form, email, automated requirements document development tool	0	-1: from 2 to 1 w/ creation of integrated Design/Code/Test team	-2: from 5 to 3 with creation of integrated Design/Code/Test team	2	3: moderate use of IT enablers, development team concept and case manager promise significant improvement
		N	Same PLUS OD: combine des/code/test OD: single mgr	same	same	same	3: diagram, separate	same
		N	5 IT: 2 non IT	0	-1	-2	3	3

Subject #32	1	Y: Test and IV&V done simultaneously	0	0	0	0	1: difficult to resolve differences in my count of IT-comm, IT-support based on my reading of the textual description of the redesign the numbers she entered in KOPeR to evaluate her redesigns	1: no use of IT or non_IT enablers. Only change is concurrent Test and IV&V processes. Will result in minimal improvement
		same	WF: delinearization OD: empowerment	same	same	same	2: diagram, separate	same
		Y	0 IT: 2 non IT	0	0	0	2	1
	2	Y: Req/Design/Code Test team and use of a case manager and Test/IV&V done simultaneously	4: LAN, email, intranet, FTP	0	-1: from 2 to one w/ creation of Req/Design/Code Test team	0	1: difficult to resolve differences in my count of IT-comm, IT-support based on my reading of the textual description of the redesign the numbers she entered in KOPeR to evaluate her redesigns.	3: significant use of IT and non IT enablers along with case manager concept promise significant improvements
		same	Same PLUS OD.: Single Mgr OD: Case Team OD: Empowerment HR: Training WR: ?? Synch Reviews	same	same	same	2: diagram, separate	same
		Y	4 IT: 5 non IT	0	-1	0	2	3
	3	Y: Req/Design/Code Test team and use of a case manager Code/Test done by a single specialist trained in both	0	-1: separate internal test activities merged w/ code... is it wise to have the same person who writes the code test it?	-1: from 2 to 1 w/ creation of Req/Design/Code Test team same	-3: from 5 to 2 w/ creation of Req/Design/Code Test team same	1: difficult to resolve differences in my count of IT-comm, IT-support based on my reading of the textual description of the redesign the numbers she entered in KOPeR to evaluate her redesigns.	1: though there is some use of non-IT enablers (devel team and case mgr), no integration of IT enablers and little change to underlying processes indicate that this redesign will yield minimal impact
		N: ??? sequential	OD: Combine Req/Des/Code OD: Case Mgr	same	same	same	1: less clear	same
		Y	0 IT: 2 non IT	-1	-1	-3	1	1

Subject #33	1	Y: Combine Design/Code/Test activities	0	0	0: unchanged from baseline same	-2: from 5 to 3 with creation of single Design/Code/Test activity same	1: unclear which activities are combined either by reading or referring to redesign digraph	1: no use of IT enablers, use of devel team concept
		N: still sequential	OD: Combine Des/Code/Test	same	same	same	2: diagram, separate, unclear	same
		N	0 IT: 1 non IT	0	0	-2	2	1
	2	Y: Combine Design/Code/Test activities	7: LAN/WAN, email, shared databases, electronic forms, electronic graphical representation, VTC, CAD	0	0: unchanged from baseline	-2: from 5 to 3 with creation of single Design/Code/Test activity	1: unclear which activities are combined either by reading or referring to redesign digraph	2: significant use of IT enablers, team concept, but little discussion on changing underlying processes to take full advantage of the enablers.
		N: still sequential	Same 7 as above, plus: OD: Combine Des/Code/Test	same	same	same	same	same
		N	7 IT: 1 non IT	0	0	-2	1	2
Subject #34	1	N	5: input form, email, auto verification of info entered in input form, network (implied, though not explicitly mentioned), form w/ macros for requirements integration	0	0: unable to determine	0: unable to determine if there is a change in handoffs as no digraph is included and textual description lacks sufficient detail.	1: since there is no digraph is included and description lacks sufficient detail, feedback loops and handoffs are indeterminate	1: good use of IT enablers, no non-IT enablers (case mgr, team concept, etc) and little discussion on changing underlying work processes. No delin
		same	same PLUS automatic queue system	same	same	same	same	same
		N	6 IT: 0 non IT	0	0	0	1	1
	2	N	4: Computer network (implied), email, partial auto form population, auto form verification	-1: sales eliminated	0: unable to determine	0: unable to determine if there is a change in handoffs as no digraph is included and textual description lacks sufficient detail.	1: since there is no digraph is included and description lacks sufficient detail, feedback loops and handoffs are indeterminate	1: good use of IT enablers, no non-IT enablers, elim of sales may limit ability to capture customer needs as a sales person can probably help capture customer needs more completely
		same	same PLUS OD Remove Sales	same	same	same	same	same
		N	4 IT: 0 non IT	-1	0	0	1	1

Subject #35	1	Y: design/code/test team	2: email, network (implied)	0	1: Not addressed by redesign, though 1 seems to be implied by KOPeR output	-2: from 5 to 3 with incorporation of combine design/code/test team	1: failure to address feedback loops makes it impossible to analyze this element of his redesign	1: minimal use of IT enablers, use of devel team concept, but no discussion on changing underlying processes or delinearizing activities
		N: still sequential	same PLUS OD: case team	0	same	same	same	same
		N	2 IT: 1 non IT	0	1	-2	1	1
	2	Y: req/design/code/test team	2: email, network (implied)	0: though unclear if req is merely combine w/ the case team or eliminated	Not addressed by redesign; feedback fraction of 0.167 is yielded by KOPeR output, but unable to determine how this number could be reached based on what's depicted in his digraph	-3: from 5 to 2 with incorporation of req/design/code/test team	1: failure to address feedback loops makes it impossible to analyze this element of his redesign; also, unclear whether req is added to the Case Team or if this activity is simply eliminated	1: minimal use of IT enablers, use of devel team concept, but no discussion on changing underlying processes or delinearizing activities
		N: still sequential	same PLUS OD: case team	same	same	same	same	same
		N	2 IT: 1 non IT	0	0	-3	1	1
Subject #36	1	Y: Sales and Requirements done simultaneously with Requirements not being dependant on Sales input	2: email, network	-1: elimination of IV&V	-1: from 2 to 1 with elimination of IV&V and its resultant feedback loop	-1: from 5 to 4 w/ elimination of IV&V	2	3: IT and non-IT enablers, case team, case manager concept all integrated with discussion on changing underlying processes (i.e requirements development process)
		N	same PLUS WF: eliminate IV&V OD: combine Sales/Req IT: Req DSS OD: PM	same	same	same	same	same
		Y	3 IT: 2 non IT	-1	-1	-1	2	3
	2	Y: Sales and Requirements done simultaneously with Requirements not being dependant on Sales input and Design/Code/Test done on an iterative basis as a team under a program manager	2: email, network	-1: elimination of IV&V	-2: from 2 to 0 with elimination of IV&V and creation of Design/Code/Test team where feedback would occur consequent to the iterative nature of the new process	-3: from 5 to 2 with elimination of IV&V and creation of Design/Code/Test team	2	3: good use of IT and non IT enablers, case team, case manager, iterative development and incremental testing



		N	same PLUS OD: combine des/code/test OD:PM IT: OOP	same	same	same	same	same
		Y	3 IT: 2 non IT	-1	-2	-3	2	3
Subject #37	1	Y: creation of req/design/code/test group under a single manager	3: network, intranet, web site	0	-1: from 1 to 2 with creation of development group. He does not explicitly address this issue, but one can infer that the feedback loop previously found between test and code would be eliminated with the combined development group in the inherent communication that would take place in such a group	-3: from 5 to 2 with creation of development group. Though it is not depicted in a digraph, he does mention that by creating the combined development group that friction would be reduced by nearly 1/2.	1: though his concepts are clear, implementation is not. Use of a digraph would have been helpful. It was also not clear if the two recommendations were separate redesigns or were both pertaining to a single redesign.	3: good use of IT and non-IT enablers, case manager, devel. Team, bring workers together in one location to reduce friction,
		Y: delin	same PLUS WF: delin OD: combine req/code/test/design OF: single mgr	same	same	same	same	same
		Y	3 IT: 3 non IT	0	-1	-3	1	3
Subject #38	1	N	4: intranet, LAN, database, email	0	0	0	2	1: use of IT enablers, no non-IT enablers, no change to underlying processes
		same	same	same	same	same	same	same
		N	4 IT: 0 non IT	0	0	0	2	1
	2	Y: combine Req/Design with a case manager and Test/IV&V	4: UML modeling, UML coding, LAN, email	-1: In one sentence he proposes merging Test with IV&V only later stating that this change effectively eliminates the Test activity	0: no change from baseline	-2: from 5 to 3 with integration of req/design and test/IV&V	2	3: significant use of IT and non IT enablers, joint reviews, case manager, devel team, training, etc promise significant improvements
		N: still sequential	same PLUS WF: joint reviews OD: combine req/des and test/IV&V OD: case mgr OD: empowerment	same	same	same	same	same
		N	4 IT: 4 non IT	-1	-0	-2	2	3

THIS PAGE INTENTIONALLY LEFT BLANK

## APPENDIX C. KOPER PATHOLOGY DIAGNOSIS AND REDESIGN ADVICE; PCS ORDERS PROCESS FOR USMC OFFICERS

### A. BASELINE PROCESS

#### 1. Diagnosis

Measurements (e.g., size of 5) suggest the *small PCS orders Process for USMC Officers* process suffers from the following pathologies:

- Parallelism (1.0) - *sequential process.*
- Handoffs fraction (0.8) - *process friction.*
- Feedback fraction (0.6) - *checking & complexity.*
- IT support fraction (2.2) - *IT support looks OK.*
- IT communication fraction (0.6) - *IT communication looks OK.*
- IT automation fraction (0.0) - *inadequate IT automation.*

#### 2. Recommendations

For redesign, we recommend you consider the following:

- **Delinearize** process activities to increase parallelism; such activities must be sequentially-independent (e.g., have mutually-exclusive inputs and outputs).
- Try a **case manager** or **case team** to decrease friction; be sure to include a source of expertise.
- Try **empowerment** to reduce the amount of checking in the process; be sure to address training and incentives.
- Look to **information technology** to **automate** process activities; automated transaction processing and expert systems generally have good payoffs and intelligent agents can enable many electronic commerce opportunities.
- Try either **asynchronous** or **contemporaneous reviews** to conduct quality/feedback loops

concurrently or jointly; scheduling becomes a concern with this redesign.

- In addition to delinearization and the use of a case manager, workflow systems offer good potential for process improvement; try to avoid **paving the cowpaths** by ignoring other process pathologies, however.

## **B. REDESIGN ALTERNATIVE #1**

### **1. Diagnosis**

Measurements (e.g., size of 5) suggest the *small PCS Orders Process for USMC Officers* suffers from the following pathologies:

- Parallelism (1.0) - *sequential process.*
- Handoffs fraction (0.8) - *process friction.*
- Feedback fraction (0.2) - *feedback looks OK.*
- IT support fraction (2.2) - *IT support looks OK.*
- IT communication fraction (0.6) - *IT communication looks OK.*
- IT automation fraction (0.2) - *inadequate IT automation.*

### **2. Recommendations**

For redesign, we recommend you consider the following:

- Delinearize process activities to increase parallelism; such activities must be sequentially independent (e.g., have mutually-exclusive inputs and outputs).
- Try a case manager or case team to decrease friction; be sure to include a source of expertise.
- Look to information technology to automate process activities; automated transaction processing and expert systems generally have good payoffs and intelligent agents can enable many electronic commerce opportunities.
- In addition to delinearization and the use of a case manager, workflow systems offer good

potential for process improvement; try to avoid paving the cowpaths by ignoring other process pathologies, however.

## **C. REDESIGN ALTERNATIVE #2**

### **1. Diagnosis**

- Measurements (e.g., size of 4) suggest the *small PCS Orders Process for USMC Officers* process suffers from the following pathologies:
- Parallelism (1.0) - *sequential process*.
- Handoffs fraction (0.75) - *process friction*.
- Feedback fraction (0.25) - *feedback looks OK*.
- IT support fraction (1.75) - *IT support looks OK*.
- IT communication fraction (0.75) - *IT communication looks OK*.
- IT automation fraction (0.75) - *IT automation looks OK*.

### **2. Recommendations**

For redesign, we recommend you consider the following:

- Delinearize process activities to increase parallelism; such activities must be sequentially independent (e.g., have mutually-exclusive inputs and outputs).
- Try a case manager or case team to decrease friction; be sure to include a source of expertise.
- In addition to delinearization and the use of a case manager, workflow systems offer good potential for process improvement; try to avoid paving the cowpaths by ignoring other process pathologies, however.

THIS PAGE INTENTIONALLY LEFT BLANK

## **APPENDIX D. EXPLANATIONS OF KOPER REDESIGN RECOMMENDATIONS**

### **A. DE-LINEARIZE**

De-linearization involves rearranging a sequence of process activities to be performed in a more parallel or concurrent manner. Process parallelism or concurrency has positive performance effects in terms of cycle time (and often cost), as activities are performed in parallel as opposed to sequentially. This redesign transformation affects the sequence and flow of process activities, but not how or by whom they are performed.

### **B. CASE MANAGER**

The case manager transformation involves replacing specialized employees in a process (often from different functional departments) with a generalist case manager who performs all process activities from start to finish. A case manager can have positive performance effects in terms of cycle time (and often cost), as a single case manager obviates the need for handoffs and inter-departmental coordination. A case team involves the same concept extended to a dedicated team of people. In the DoD, these are referred to as 'integrated product teams' (IPTs).

### **C. EMPOWERMENT**

Empowerment involves delegating responsibility to front-line employees and authorizing the people doing process work to ensure the quality of their work. Empowerment can have positive performance effects in terms of cost and cycle time, as quality 'checking' steps can be

avoided and empowered employees often produce superior work products at lower cost. Empowerment entails some job enlargement.

**D. IT SUPPORT**

IT-Support involves the application of information technology (IT) to support process activities. This powerful redesign transformation can have positive performance effects in terms of cost and cycle time, as computer-based tools can augment human performance in terms of memory, speed, thoroughness and other attributes. As a 'support' enabler, IT in this class is used in conjunction with human labor (i.e., in contrast to IT-Automation).

**E. IT COMMUNICATION**

IT-Communication involves the application of information technology (IT) to support process communications. This powerful redesign transformation can have positive performance effects in terms of cost and cycle time, as computer-based tools can replace slow paper-based communications.

**F. IT AUTOMATION**

IT-Automation involves the application of information technology (IT) to automate process activities. This powerful redesign transformation can have positive performance effects in terms of cost and cycle time, as computer-based tools can replace and improve human performance. As a 'automation' enabler, IT in this class is used to obviate human labor (i.e., in contrast to IT-support).



### **G. JOINT REVIEWS**

The joint reviews transformation serves to eliminate the pathologies associated with a sequence of quality/feedback loops in a process. This can have positive performance effects in terms of cycle time, as reviews are handled once by all interested parties. However, this approach can actually increase cost if reviews are not managed effectively. Scheduling also becomes a concern.

### **H. SEQUENTIAL INDEPENDENCE**

Delinearization can significantly reduce process cycle time, particularly when high-level process activities are delinearized. But if two process activities are sequentially dependent, they cannot be performed concurrently; rather, they must continue to be performed in series.

One test for sequential-independence is to analyze the inputs to, and outputs from, each process activity. Where the inputs to an activity (call it Step-2) are *not* produced by the preceding activity (call it Step-1), the two activities offer good opportunity to be performed in parallel.

### **I. EXPERTISE**

When a case manager or case team is instituted, the personnel performing in such process roles are usually generalists--broadly skilled in at number of different jobs--who are seldom endowed with expertise across all required tasks and activities.

The generalist worker(s) can be expected to perform well, so long as the process activities are not unusual, complex or novel. Performance of work that is not customary, simple and familiar often requires deeper expertise than is possessed by a generalist case manager. Thus, expertise is required to support the generalist in these situations.

Expertise is most commonly provided through retention of some expert personnel, who can serve as advisors or internal consultants when problems arise. With the advance of knowledge systems technology, however, much of this expertise can be captured and formalized through intelligent systems. Expert systems for problem diagnosis, neural networks for pattern recognition, case-based reasoning systems for help desks, intelligent agents for information filtering, and other intelligent applications represent potential, alternative sources of expertise.

#### **J. TRAINING AND INCENTIVES**

Empowerment can create a number of process improvements by authorizing decisions to be made personnel who are directly responsible for performing process work. This can eliminate lengthy decision-making and feedback loops, and can augment process quality.

However, employees who are unaccustomed to making decisions are likely to require training, in addition to having the requisite decision-making information provided. This represents a critical factor to the success of empowerment.

Personnel who are newly empowered are also likely to perceive a (real) increase in their level of responsibility. This represents a key motivating factor behind the increased process quality noted above, but the personnel must also be incentivized to take-on this additional (perceived) responsibility. Monetary compensation is not necessarily required, as employer-sponsored training, expanded job title, business cards, improved office surroundings and other factors can also incentivize many people.

#### **K. IT TRAINING AND MAINTENANCE**

Information technology represents a very powerful enabler of process innovation. IT to support process activities and communications requires personnel training in many organizations, however. Indeed, many techno-phobic employees will find new IT threatening, and are likely to resist change. Training represents one approach to addressing such employees.

Techno-phobic or not, simply inserting new IT into a (human) process cannot be expected to produce dramatic process improvements unless the personnel are adequately trained to use the IT. Although this appears evident, many good redesigns have failed for lack of training.

Additionally, IT needs to be maintained. Computer hardware requires repair and upgrading. New releases of software require installation. Databases and networks require administration. Indeed, software maintenance, for example, is known to consume roughly two-thirds of the total life cycle cost for software.

#### **L. AUTOMATION AND ELECTRONIC COMMERCE**

Automation implies that IT is being employed to *perform* process activities instead of people, and represents a different class of redesign transformation than either IT support or communication. Yet an infrastructure of IT for support and communication is generally necessary for effective automation.

Automated transaction process systems are well known for this effect and expert systems are increasingly being used to automate some aspects of knowledge work. With the advent of intelligent-agent technology, automation is reaching beyond routine transactions and self-contained expertise, and extending across network linkages to automate *coordination and collaboration* work as well.

Much coordination and collaboration work is now accomplished between organizations and intelligent agents are playing an increasingly important role in this area. For example, using former EDI connectivity links, customers, channels and suppliers are finding an enhanced ability to locate, interact and conduct business with one another, without human intervention.

#### **M. IT INFRASTRUCTURE**

An IT infrastructure is particularly important to support the automation of knowledge and information work, and is generally considered to represent a necessary precondition for success. IT to support process activities (e.g., computers, software, decision support systems, databases, word processors, etc.) and communications (esp.

e-mail, Intranets, workflow systems) represent key infrastructural elements.

A workflow system is often required to support many approaches to knowledge-work automation, particularly where work crosses agent roles and organizational boundaries. Intelligent agents require knowledge and information in digital form, so these, basic IT infrastructural elements are required even to begin such automation work.

#### **N. SCHEDULING**

Asynchronous reviews are less prone to scheduling concerns than their contemporaneous (i.e., joint) counterparts. When busy people must interact jointly, finding mutually-acceptable slack times in their schedules becomes exponentially more difficult as the number of required participants increases.

Setting aside fixed times during the day, week, or month to address such reviews represents one approach to addressing scheduling concerns, and minimizing the number of required attendees is another proven heuristic. Also ensuring that all issues that can be resolved before such meetings can be crucial.

#### **O. WORKFLOW**

Workflow systems can support process activities through shared databases and networked communications, in addition to automatically routing work to the right agent(s) at the right time. This can save both process time and money. However, see the caution above regarding IT training and maintenance.

Most extant workflow applications are relatively rigid, in that once a process is defined, it cannot be changed dynamically (e.g., in response to in-process circumstances). Also, unless the underlying process work itself is changed, a workflow system can simply "pave the cowpaths" and speed-up the current "broken" process. Indeed, with new interfaces and without personnel training, workflow systems can even *increase* process cycle time, despite electronic communications that occur at speeds near that of light.

The key is to redesign the underlying process work first, then ensure an adequate IT infrastructure, then look into workflow automation. As a note, workflow systems provide a wonderful infrastructural foundation for intelligent-agent applications.

## LIST OF REFERENCES

- Davenport, T. H., *Process Innovation: Reengineering Work through Information Technology*, Harvard Business School Press, 1993
- Jick, Todd D., *Managing Change: Cases and Concepts*, McGraw-Hill, 1993
- MCO P1000.6G ACTS Manual
- MCO P1300.8R The Marine Corps Personnel Assignment Policy  
Officer Development Handbook (MMA)
- Nissen, M.E., "Redesigning Reengineering through Measurement Driven Inference," *MIS Quarterly* 22:4 (1998), pp. 509-534
- Nissen, M.E., "Experimental Assessment of a Process Workflow Redesign Agent," *Proceedings Hawaii International Conference on System Sciences*, Maui, HI (January 2000)
- Nissen, M.E., "A Focused Review of the Reengineering Literature: Expert Frequently Asked Questions," *QMJ* 96 3, no. 3, pp. 52-66

THIS PAGE INTENTIONALLY LEFT BLANK



## INITIAL DISTRIBUTION LIST

1. Defense Technical Information Center  
Ft. Belvoir, Virginia
2. Dudley Knox Library  
Naval Postgraduate School  
Monterey, California
3. Marine Corps Representative  
Naval Postgraduate School  
Monterey, California  

---

---

---
4. Director, Training and Education, MCCDC, Code C46  
Quantico, Virginia  

---
5. Director, Marine Corps Research Center, MCCDC, Code  
C40RC  
Quantico, Virginia  

---

---

---
6. Marine Corps Tactical Systems Support Activity (Attn:  
Operations Officer)  
Camp Pendleton, California  

---

---
7. Dr. Mark E. Nissen  
555 Dyer Road, Code SBPP/Ni  
Monterey, California 93943-5000  

---
8. Dr. Erik Jansen  
555 Dyer Road, Code SBPP/Ja  
Monterey, California 93943-5000  

---