



**Calhoun: The NPS Institutional Archive**  
**DSpace Repository**

---

NPS Scholarship

Theses

---

2008-12

# Enhancing combat survivability of existing unmanned aircraft systems

Tham, Kine Seng

Monterey, California

---

<https://hdl.handle.net/10945/3734>

---

*Downloaded from NPS Archive: Calhoun*



Calhoun is the Naval Postgraduate School's public access digital repository for research materials and institutional publications created by the NPS community. Calhoun is named for Professor of Mathematics Guy K. Calhoun, NPS's first appointed -- and published -- scholarly author.

**Dudley Knox Library / Naval Postgraduate School**  
**411 Dyer Road / 1 University Circle**  
**Monterey, California USA 93943**

<http://www.nps.edu/library>



**NAVAL  
POSTGRADUATE  
SCHOOL**

**MONTEREY, CALIFORNIA**

**THESIS**

**ENHANCING COMBAT SURVIVABILITY OF EXISTING  
UNMANNED AIRCRAFT SYSTEMS**

by

Kine Seng Tham

December 2008

Thesis Co-Advisors:

Gary Langford  
Ravi Vaidyanathan

**Approved for public release; distribution is unlimited.**

THIS PAGE INTENTIONALLY LEFT BLANK

<b>REPORT DOCUMENTATION PAGE</b>			<i>Form Approved OMB No. 0704-0188</i>	
Public reporting burden for this collection of information is estimated to average 1 hour per response, including the time for reviewing instruction, searching existing data sources, gathering and maintaining the data needed, and completing and reviewing the collection of information. Send comments regarding this burden estimate or any other aspect of this collection of information, including suggestions for reducing this burden, to Washington headquarters Services, Directorate for Information Operations and Reports, 1215 Jefferson Davis Highway, Suite 1204, Arlington, VA 22202- 4302, and to the Office of Management and Budget, Paperwork Reduction Project (0704-0188) Washington DC 20503.				
<b>1. AGENCY USE ONLY (Leave blank)</b>		<b>2. REPORT DATE</b> December 2008	<b>3. REPORT TYPE AND DATES COVERED</b> Master's Thesis	
<b>4. TITLE AND SUBTITLE</b> Enhancing Combat Survivability of Existing Unmanned Aircraft Systems			<b>5. FUNDING NUMBERS</b>	
<b>6. AUTHOR(S)</b> Kine Seng Tham			<b>8. PERFORMING ORGANIZATION REPORT NUMBER</b>	
<b>7. PERFORMING ORGANIZATION NAME(S) AND ADDRESS(ES)</b> Naval Postgraduate School Monterey, CA 93943-5000			<b>10. SPONSORING / MONITORING AGENCY REPORT NUMBER</b>	
<b>9. SPONSORING / MONITORING AGENCY NAME(S) AND ADDRESS(ES)</b> - N/A -			<b>11. SUPPLEMENTARY NOTES</b> The views expressed in this thesis are those of the author and do not reflect the official policy or position of the Department of Defense or the U.S. Government.	
<b>12a. DISTRIBUTION / AVAILABILITY STATEMENT</b> Approved for public release; distribution is unlimited			<b>12b. DISTRIBUTION CODE</b>	
<b>13. ABSTRACT (maximum 200 words)</b>  The importance of Unmanned Aircraft Systems (UAS) to warfighters has been growing. Each loss (regardless of whether the entire UAS or parts of it) has become more expensive and unaffordable in both an operational and monetary sense. An unmanned aircraft (UA) loss may mean that critical missions cannot be performed and millions of dollars of investments on the UA lost. As most existing UAS were designed to be inexpensive and expendable, there is a need to enhance their combat survivability. Combat survivability is the capability of UAS to avoid or withstand a man-made hostile environment. This thesis explored how to enhance the combat survivability of existing UAS. Potential survivability enhancement options are identified. These options include changes in tactics, improving the situation awareness of the operator, equipping the UA with the capability to counter an incoming threat, improving the payload performance, improving resistance of the data link to jamming. The technology behind these options as well as the favorable and unfavorable factors of the options are studied and discussed. This thesis also proposed a process for selecting the "best" solution from survivability enhancement alternatives. This thesis used systems engineering methodology to enhance the survivability of existing UAS.				
<b>14. SUBJECT TERMS</b> Systems Engineering, Unmanned Aircraft System, UAS, Unmanned Aerial Vehicle, UAV, Combat Survivability, Survivability, Survivability Enhancement			<b>15. NUMBER OF PAGES</b> 149	
			<b>16. PRICE CODE</b>	
<b>17. SECURITY CLASSIFICATION OF REPORT</b> Unclassified	<b>18. SECURITY CLASSIFICATION OF THIS PAGE</b> Unclassified	<b>19. SECURITY CLASSIFICATION OF ABSTRACT</b> Unclassified	<b>20. LIMITATION OF ABSTRACT</b> UU	

THIS PAGE INTENTIONALLY LEFT BLANK

**Approved for public release; distribution is unlimited**

**ENHANCING COMBAT SURVIVABILITY OF EXISTING  
UNMANNED AIRCRAFT SYSTEMS**

Kine Seng Tham  
Civilian, Defence Science & Technology Agency, Singapore  
B.Eng (Hons), National University of Singapore, 2002

Submitted in partial fulfillment of the  
requirements for the degree of

**MASTER OF SCIENCE IN SYSTEMS ENGINEERING**

from the

**NAVAL POSTGRADUATE SCHOOL  
December 2008**

Author: Kine Seng Tham

Approved by: Gary O. Langford  
Thesis Co-Advisor

Ravi Vaidyanathan  
Thesis Co-Advisor

David H. Olwell  
Chair, Systems Engineering Department

THIS PAGE INTENTIONALLY LEFT BLANK

## **ABSTRACT**

The importance of Unmanned Aircraft Systems (UAS) to warfighters has been growing. Each loss (regardless of whether the entire UAS or parts of it) has become more expensive and unaffordable in both an operational and monetary sense. An unmanned aircraft (UA) loss may mean that critical missions cannot be performed and millions of dollars of investments on the UA lost. As most existing UAS were designed to be inexpensive and expendable, there is a need to enhance their combat survivability. Combat survivability is the capability of UAS to avoid or withstand a man-made hostile environment. This thesis explored how to enhance the combat survivability of existing UAS. Potential survivability enhancement options are identified. These options include changes in tactics, improving the situation awareness of the operator, equipping the UA with the capability to counter an incoming threat, improving the payload performance, improving resistance of the data link to jamming. The technology behind these options as well as the favorable and unfavorable factors of the options are studied and discussed. This thesis also proposed a process for selecting the “best” solution from survivability enhancement alternatives. This thesis used systems engineering methodology to enhance the survivability of existing UAS.



THIS PAGE INTENTIONALLY LEFT BLANK

# TABLE OF CONTENTS

<b>I.</b>	<b>INTRODUCTION.....</b>	<b>1</b>
	<b>A. BACKGROUND .....</b>	<b>1</b>
	<b>B. PURPOSE.....</b>	<b>4</b>
	<b>C. RESEARCH QUESTIONS.....</b>	<b>4</b>
	<b>D. SCOPE .....</b>	<b>4</b>
	<b>E. METHODOLOGY .....</b>	<b>5</b>
	<b>1. Define Problem.....</b>	<b>5</b>
	<b>2. Functional Analysis of Adversary Wanting to Affect UAS     Mission Effectiveness.....</b>	<b>5</b>
	<b>3. Develop the Kill Chain.....</b>	<b>5</b>
	<b>4. Perform a Functional Analysis on Enhancing Combat     Survivability of UAS.....</b>	<b>6</b>
	<b>5. Define Concepts that Can Be Used to Achieve Combat     Survivability .....</b>	<b>6</b>
	<b>6. Perform Physical Decomposition of UAS .....</b>	<b>6</b>
	<b>7. Perform Functional Analysis of the Top Priority Mission.....</b>	<b>6</b>
	<b>8. Identify Potential Threats to UAS.....</b>	<b>7</b>
	<b>9. Identify UAS Weakness (With Reference To Combat     Survivability).....</b>	<b>7</b>
	<b>10. Determine Survivability Enhancement Options .....</b>	<b>7</b>
	<b>11. Develop Selection Process.....</b>	<b>7</b>
	<b>F. THESIS FLOW.....</b>	<b>8</b>
	<b>G. CHAPTER SUMMARY.....</b>	<b>8</b>
<b>II.</b>	<b>COMBAT SURVIVABILITY .....</b>	<b>9</b>
	<b>A. SURVIVABILITY, SYSTEM SAFETY, AND COMBAT SURVIVABILITY .....</b>	<b>9</b>
	<b>1. Susceptibility .....</b>	<b>10</b>
	<b>2. Vulnerability.....</b>	<b>11</b>
	<b>B. ADVERSARY’S OBJECTIVE.....</b>	<b>11</b>
	<b>C. ENHANCING COMBAT SURVIVABILITY .....</b>	<b>13</b>
	<b>1. Reducing Susceptibility .....</b>	<b>17</b>
	<b>a. Gather Intelligence about Threat.....</b>	<b>17</b>
	<b>b. Threat Warning.....</b>	<b>17</b>
	<b>c. Increase Stand-off Range .....</b>	<b>18</b>
	<b>d. Improve System Performance.....</b>	<b>18</b>
	<b>e. Threat Suppression .....</b>	<b>18</b>
	<b>f. Signature Reduction .....</b>	<b>18</b>
	<b>g. Jamming and Deceiving .....</b>	<b>19</b>
	<b>h. Tactics and Crew Training and Proficiency .....</b>	<b>20</b>
	<b>i. Expendables .....</b>	<b>20</b>
	<b>2. Reducing Vulnerability .....</b>	<b>20</b>
	<b>a. Damage Suppression.....</b>	<b>21</b>

	<i>b.</i>	<i>Component Redundancy (With Separation)</i> .....	21
	<i>c.</i>	<i>Component Location</i> .....	22
	<i>d.</i>	<i>Component Shielding</i> .....	22
	<i>e.</i>	<i>Component Elimination or Replacement</i> .....	22
	D.	CHAPTER SUMMARY.....	22
III.		UNMANNED AIRCRAFT SYSTEM .....	23
	A.	OVERVIEW OF AN UNMANNED AIRCRAFT SYSTEM .....	23
	1.	Unmanned Aircraft.....	23
	2.	Ground Control Station .....	25
	3.	Launch and Recovery System.....	27
	4.	Payloads .....	28
	5.	Data Links.....	28
	6.	Ground Support Equipment.....	31
	7.	Physical Decomposition of UAS.....	31
	B.	MISSION .....	34
	1.	Mission Priorities for UAS .....	35
	2.	Intelligence, Surveillance and Reconnaissance .....	37
	<i>a.</i>	<i>Payload</i> .....	38
	3.	Precision Target Location and Designation .....	39
	C.	FUNCTIONS REQUIRED TO PERFORM MISSION .....	39
	D.	CHAPTER SUMMARY.....	44
IV.		THREAT TO UAS.....	45
	A.	INTELLIGENCE.....	45
	B.	SEARCH AND SURVEILLANCE CAPABILITIES.....	46
	1.	Radar.....	46
	2.	Electro-Optical Sensors .....	47
	3.	Thermal Imager .....	47
	4.	Passive Radio Frequency Intercept.....	47
	C.	THREAT WITH HARD-KILL CAPABILITY .....	48
	1.	Anti-Aircraft Artillery.....	48
	2.	Surface-Air Missile .....	48
	3.	Other Aircraft .....	49
	4.	Ground Forces.....	49
	D.	THREAT WITH SOFT-KILL CAPABILITY .....	50
	1.	Jamming.....	50
	2.	Software Virus.....	50
	3.	Electromagnetic Pulse (EMP).....	51
	E.	CHAPTER SUMMARY.....	51
V.		UAS WEAKNESSES .....	53
	A.	WEAKNESSES DUE TO PHYSICAL COMPONENTS .....	53
	B.	WEAKNESSES DUE TO PERFORMING FUNCTIONS .....	53
	C.	IDENTIFY UAS WEAKNESSES .....	54
	D.	CHAPTER SUMMARY.....	59
VI.		COMBAT SURVIVABILITY ENHANCEMENT OPTIONS .....	61

A.	UNMANNED AIRCRAFT.....	61
1.	Increase Operating Altitude.....	61
2.	Change Operating Speed.....	62
3.	Improve Situational Awareness.....	63
	<i>a. Radar Warning Receiver System.....</i>	<i>64</i>
	<i>b. Missile Warning System .....</i>	<i>65</i>
	<i>c. Laser Warning System.....</i>	<i>67</i>
	<i>d. Considerations for Choosing Warning System.....</i>	<i>68</i>
4.	Countering Incoming Threats .....	69
	<i>a. Install Electronic Countermeasures.....</i>	<i>69</i>
	<i>b. Arm UA to Shoot At Incoming Threats.....</i>	<i>77</i>
5.	Reduce Signature .....	78
6.	Strengthen Damage Tolerance.....	79
7.	Improve Autonomy.....	79
8.	Redundant Navigation Systems.....	80
B.	PAYLOAD.....	80
C.	GROUND ELEMENT.....	82
D.	DATA LINK.....	84
1.	Low Probability of Intercept.....	84
2.	Encryption .....	85
3.	Resistance to Jamming .....	85
	<i>a. Increasing Transmitter Power.....</i>	<i>86</i>
	<i>b. Increasing Antenna Gain .....</i>	<i>86</i>
	<i>c. Processing Gain .....</i>	<i>87</i>
	<i>d. Discussion About Jam Resistance.....</i>	<i>88</i>
	<i>e. Reducing Impact of Data Link Jamming.....</i>	<i>88</i>
4.	Resistance to Deception .....	89
E.	OPERATOR.....	89
F.	CHAPTER SUMMARY.....	90
VII.	SELECTING COMBAT SURVIVABILITY ENHANCEMENT SOLUTIONS FOR AN EXISTING UAS .....	91
A.	ESTABLISH THE NEED TO ENHANCE COMBAT SURVIVABILITY .....	92
B.	FEASIBILITY ANALYSIS.....	93
C.	IDENTIFY OBJECTIVES AND DEFINE REQUIREMENTS.....	94
D.	FUNCTIONAL ANALYSIS .....	95
E.	FUNCTIONAL AND REQUIREMENTS ALLOCATION.....	95
F.	EVALUATE COMBAT SURVIVABILITY ENHANCEMENT SOLUTIONS .....	96
1.	Effectiveness of Solution.....	97
2.	UAS Performance .....	97
3.	Reliability.....	97
4.	Maintainability .....	98
5.	Supportability.....	98
6.	System Safety.....	98

7.	Dollar Cost.....	99
8.	Schedule/Time Line .....	99
G.	SELECTING THE COMBAT SURVIVABILITY ENHANCEMENT SOLUTION .....	100
H.	EXAMPLE.....	101
1.	Establishing Needs .....	102
a.	<i>Importance of UAS</i> .....	102
b.	<i>Threat</i> .....	102
c.	<i>Current Combat Survivability</i> .....	103
2.	Feasibility Study.....	103
a.	<i>Feasibility</i> .....	107
3.	Objectives and Requirements Defined.....	107
4.	Functional Analysis.....	108
5.	Functional and Requirement Allocation.....	111
6.	Evaluating and Selecting Combat Survivability Enhancement Solutions.....	111
a.	<i>Effectiveness</i> .....	112
b.	<i>Performance</i> .....	113
c.	<i>Compatibility</i> .....	113
d.	<i>Availability</i> .....	114
e.	<i>“Best” Solution</i> .....	114
I.	CHAPTER SUMMARY.....	115
VII.	CONCLUSION .....	117
	LIST OF REFERENCES.....	119
	INITIAL DISTRIBUTION LIST .....	123

## LIST OF FIGURES

Figure 1.	Functional Decomposition of “To Enhance Combat Survivability of UAS.”.....	xx
Figure 2.	A Curtiss-Sperry Aerial Torpedo.....	1
Figure 3.	A TDR-1 Carrying a Torpedo Underneath Its Fuselage.....	2
Figure 4.	Relationship Between Combat Survivability, Survivability, and System Safety. ....	10
Figure 5.	Functional Decomposition of Adversary Reducing UAS Effectiveness. ....	12
Figure 6.	A Single Shot Kill Chain to Kill A UAS. ....	14
Figure 7.	Functional Decomposition of “To Enhance Combat Survivability of UAS.”.....	15
Figure 8.	A Generic UAS.....	23
Figure 9.	A Look Inside the RQ-1 Predator. ....	24
Figure 10.	A Handheld Computer Serving as the Ground Control Station for the Skylark Mini UAV.....	25
Figure 11.	A Typical Ground Control Station.....	26
Figure 12.	ScanEagle Launched Using A Catapult.....	27
Figure 13.	Elements of a UAS Data Link .....	29
Figure 14.	A Ground Data Terminal – EL/K-1861 .....	30
Figure 15.	RQ-4 Global Hawk Communications Architecture Showing Various Data Links. ....	31
Figure 16.	Physical Decomposition of UAS .....	34
Figure 17.	Functions Required to Perform Unmanned Aircraft System Reconnaissance Operations. ....	43
Figure 18.	The LR-100 RWR System Shown with Azimuth Antenna Interferometer Unit (Four Each), Antenna Interface Unit, and Receiver Processor Unit.....	65
Figure 19.	Summary of Threat Warning Systems.....	68
Figure 20.	Different Configuration of Airborne Towed Decoy .....	74
Figure 21.	A Two-color Sensor can Determine the Temperature of its Target by Comparing the Energy at Two Frequencies.....	76
Figure 22.	Aperture Size Requirements for Different Sensors and Imaging Functions....	82
Figure 23.	Illustration of the Geometrical Discrimination Between a Signal and a Jammer Using a High-Gain Antenna ( $G_S$ and $G_J$ are the Gain for the Desired Signal and Jammer Respectively) .....	87
Figure 24.	AHP Comparison Matrix for the Requirements. ....	108
Figure 25.	AHP Comparison Using Effectiveness as the Ranking Criteria. ....	112
Figure 26.	AHP Comparison Using Performance as the Ranking Criteria. ....	113
Figure 27.	AHP Comparison Using Compatibility as the Ranking Criteria. ....	114
Figure 28.	AHP Comparison Using Availability as the Ranking Criteria. ....	114
Figure 29.	Overall Results.....	115

THIS PAGE INTENTIONALLY LEFT BLANK

## LIST OF TABLES

Table 1.	Survivability Enhancement Functions .....	16
Table 2.	Some Signature Reduction Method. ....	19
Table 3.	COCOM and Military Department UAS Needs Prioritized By Aircraft Class.....	36
Table 4.	Physical Components That Either Emit Signal Or If Degraded, Will Lead To Destruction of UAS .....	54
Table 5.	Functions That Either Emit a Signal Or If Degraded, Will Lead To Destruction of UAS.....	55
Table 6.	UAS Weaknesses And Corresponding Survivability Enhancement Concepts To Improve Or Eliminate Weaknesses .....	58
Table 7.	Strengths and Weaknesses Of Various MWS Technologies .....	66
Table 8.	UAS Shortcoming And Possible Remedies .....	104
Table 9.	Functional Decomposition of “To Counter Incoming Threat” and Physical Component Identification .....	109



THIS PAGE INTENTIONALLY LEFT BLANK

## **LIST OF ACRONYMS AND ABBREVIATIONS**

AWACS	Airborne Warning and Control System
AHP	Analytic Hierarchy Process
AAA	Anti-Aircraft Artillery
BCA	Benefit-Cost Analysis
COCOM	Combatant Commanders
CONOPS	Concept of Operations
CM	Countermeasure
EMC	Electromagnetic Compatibility
EMI	Electromagnetic Interference
EMP	Electromagnetic Pulse
EA	Electronic Attack
ECM	Electronic Countermeasure
ELINT	Electronic Intelligence
ESM	Electronic Support Measures
EW	Electronic Warfare
EO	Electro-Optics
FLIR	Forward Looking Infrared
GPS	Global Positioning System
GCS	Ground Control Station
GSE	Ground Support Equipment
IMINT	Imagery Intelligence
INS	Inertia Navigation System

IR	Infrared
IADS	Integrated Air Defense System
ISS	Integrated Sensor Suit
ISS	Integrated Sensor Suite
ISR	Intelligence, Surveillance and Reconnaissance
LWS	Laser Warning System
LRE	Launch and Recovery Element
LOS	Line-Of-Sight
LPI	Low Probability of Intercept
MANPADS	Man Portable Air Defense System
MOE	Measures of Effectiveness
MOP	Measures of Performance
MALE	Medium Altitude, Long Endurance
MAWS	Missile Approach Warning System
MCE	Mission Control Element
OSD	Office of the Secretary of Defense
O&S	Operation and Support
OEF	Operation Enduring Freedom
OIF	Operation Iraqi Freedom
PGM	Precision Guided Munitions
RAM	Radar Absorbent Material
RCS	Radar Cross-Section
RWR	Radar Warning Receivers

RF	Radio Frequency
ROVER	Remotely Operated Video Enhanced Receiver
SIGINT	Signal Intelligence
SEAD	Suppression of Enemy Air Defense
SAM	Surface-to-Air Missile
SAR	Synthetic Aperture Radar
SE	Systems Engineering
TPM	Technical Performance Measures
TCO	Total Cost of Ownership
USAF	U.S. Air Force
USN	U.S. Navy
UAV	Unmanned Aerial Vehicle
UA	Unmanned Aircraft
UAS	Unmanned Aircraft System
UCAS	Unmanned Combat Aircraft System
WWI	World War One
WWII	World War Two

THIS PAGE INTENTIONALLY LEFT BLANK

## **EXECUTIVE SUMMARY**

The importance of Unmanned Aircraft Systems (UAS) to warfighters has been growing as the sphere of UAS combat applications keeps increasing. In the past, UAS advocates gave minimal consideration to survivability with the view that UAS were to be inexpensive and expendable. Most current unmanned aircrafts (UA) are likely designed to be simple, require minimal number of components, and be as light as possible. However, as the dependence of modern warfighting units on UAS increases, the consequences of occasional disruptive losses become more severe. Also with today's high unit cost of UAS, UAS can no longer be considered inexpensive. Each loss becomes more expensive and unaffordable in both operational and monetary sense. Combat survivability of UAS, therefore, needs to be enhanced. This improvement should be done with minimal cost and penalty to the performance of UAS.

This thesis acts as a guide to enhancing survivability of existing UAS by describing (1) the functions required to enhance combat survivability of UAS, (2) the major components of a UAS and its missions, (3) the threats that a UAS will likely encounter, (4) UAS weaknesses, (5) potential survivability enhancement options, and (6) a process to determine the need to enhance combat survivability of an existing UAS and select the "best" solution.

A functional analysis of "to enhance combat survivability of UAS" was performed. The identified functions required to enhance combat survivability of UAS are 1) do not move into the threat area, 2) prevent threat from operating, 3) prevent threat from detecting, identifying and classifying UAS, 4) prevent threat from obtaining a firing solution, 5) prevent threat damage mechanism from reaching the UAS, 6) increase UAS damage tolerance, and 7) increase UAS damage resistance. See Figure 1.

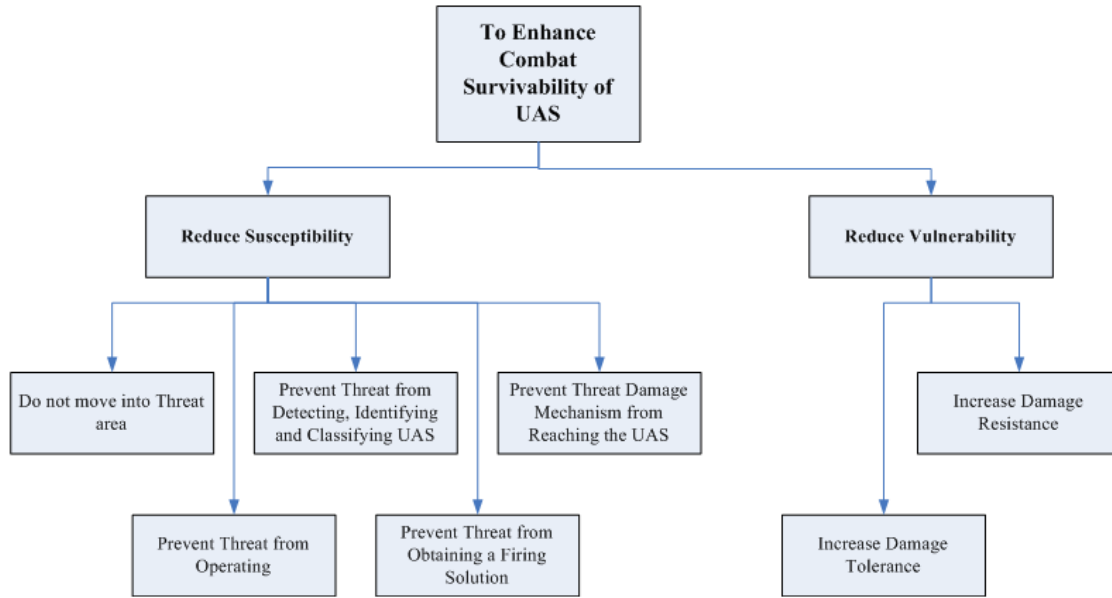

Figure 1. Functional Decomposition of “To Enhance Combat Survivability of UAS.”

Each of these functions could be achieved by numerous other sub-functions or concepts. These concepts are 1) gather intelligence about threat, 2) warn about presence of threat, 3) increase stand-off range, 4) improve system performance, 5) suppress threat, 6) reduce signature of UAS, 7) jam or deceive threat sensor, 8) enhance tactics and training, 9) improve system performance, 10) distract threat propagator using expendables, 11) suppress damage, 12) install redundant components (with separation), 13) locate critical components in a way that reduce probability of the damage from killing UAS, 14) shield critical components, and 15) eliminate components. These concepts produce survivability enhancement options that can be considered.

A physical decomposition of UAS and a functional analysis of “UAS performing reconnaissance operations” were performed. The results were combined to identify UAS weaknesses. The weaknesses include components having large RCS or high IR signature, having communication system and payload that are susceptible to jamming, having components that are software-driven and susceptible to software virus attack, and degradation of some functions related to mission planning would lead to UAS destruction. The adversary can exploit these weaknesses to detect, identify, and track

UAS or attack the weaknesses to destroy it. Combat survivability enhancement options were identified to ameliorate or eliminate these weaknesses.

Some of the survivability enhancement options include increasing the operating altitude of UAs, changing the UA's operating speed, installing warning systems and/or electronic countermeasures, improving payload performance, improving the data link (such as reducing its probability of interception), and improving human factor issues in UAS. The technology behind the options as well as the favorable and unfavorable factors of the key options were studied and discussed.

The thesis concludes by proposing a process that can be used to determine the need to enhance the combat survivability of an existing UAS, and once the need is established, select the "best" solution. The process starts with establishing the need for enhancing combat survivability of UAS. The need is dependent upon many factors that includes the types of mission to be accomplished, the criticality of these mission(s), the threats encountered by UAS in its operating environment, and the number of UAS available, taking into account the UA as well as the payload. Once the need is established, the next step is to perform a feasibility analysis. The analysis involves (1) identifying possible top-level approaches that can meet the need; (2) evaluating the approaches in terms of effectiveness, impact on the existing UAS, maintenance and sustaining support requirements, associated risk (technological, schedule, program, etc.), and life-cycle costs; and (3) selecting the preferred approach. After the feasibility analysis is done, the next step is to identify objectives and define the requirements for enhancing combat survivability. This is followed by performing a functional analysis to identify all the resources (or physical components) necessary for the system to accomplish its mission. The functional analysis is followed by mapping all functions to physical components and allocating requirements to each component. Potential combat survivability enhancement solutions are then identified and evaluated based on (1) effectiveness of the solution; (2) how the solution will affect UAS performance, reliability, maintainability, supportability and system safety; (3) cost of the solution; and (4) schedule. The "best" combat survivability enhancement solution is then selected. The definition of "best" depends on the customer's top criteria for enhancing UAS



combat survivability. The customer may be asking for the most cost-effective solution, the solution with the least operational impact to the existing system, the solution with minimal cost, or the most beneficial solution that is within the budget, etc.

## **ACKNOWLEDGMENTS**

I will first like to thank the lecturers and staff of Naval Postgraduate School for making my learning experience here a wonderful one. They are the ones who brought course material to life. Special thanks to my thesis advisors, Professor Gary Langford and Dr. Ravi Vaidyanathan for their dedicated efforts in helping me to make this thesis possible. Professor Langford was particularly open to ideas and expanded my thinking to areas I never knew existed. Professor Langford also ensured that I learned something from this process. Professor Ravi provided his experience and wisdom without hesitation.

Finally, and most importantly, I will like to thank my wife, Pearlyn, for providing tremendous support throughout the entire process. She fed me when I was hungry, took great care of the house so that I could have a decent place to go back to everyday, and sacrificed our “together” time when I needed extra time to work. Thank you for your understanding and support.

THIS PAGE INTENTIONALLY LEFT BLANK

# I. INTRODUCTION

## A. BACKGROUND

Unmanned Aircraft Systems (UAS)<sup>1</sup>, more commonly known as Unmanned Aerial Vehicle (UAV) Systems, first became a recognized system when a Curtiss-Sperry Aerial Torpedo (also known as “Curtis-Sperry Flying Bomb”, shown in Figure 2) became the first powered unmanned aircraft to fly on March 6, 1918 [1]. The U.S. Navy (USN) started the aerial “torpedo” program during World War One (WWI) for use against German U-boat bases and munitions factories from distances of up to 100 miles.

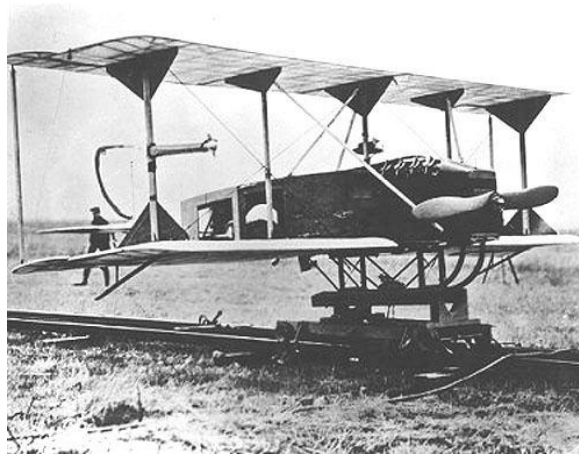

Figure 2. A Curtiss-Sperry Aerial Torpedo [From 2].

The first use of UAS in combat by the U.S., however, was during WWII. TDR-1 assault drones (shown in Figure 3) were used as aerial bombs and to drop bombs on Japanese positions in the Pacific. During its short operation life of two months, three out of fifty aircraft were lost to hostile fire.

---

<sup>1</sup> With efforts underway to develop rules integrating UAS's into the National Airspace System, and realizing that Federal Aviation Administration rule-making authority applied only to "aircraft," the term Remotely Operated Aircraft (ROA) was coined in 1997 to ensure unmanned aerial vehicles (the old term) were covered under FAA's statutory language. This was changed in 2004 when the FAA (and DoD) adopted the more inclusive term Unmanned Aircraft System (UAS). The FAA had adopted the acronym UAS to reflect the fact that these complex systems include ground stations and other elements besides the actual unmanned aircrafts.



Figure 3. A TDR-1 Carrying a Torpedo Underneath Its Fuselage [From 3].

Over the years, the roles of UAS have evolved from being “flying bombs” to flying targets, then to decoys followed by reconnaissance platforms, and recently, firing platforms. The importance of UAS to warfighters has been growing as the sphere of UAS combat applications keeps increasing. Reports from the war in Afghanistan point to UAS as one of three principal contributors to the success of the U.S. campaign to root out the Taliban and Al Qaeda terrorist elements [4]. The growing importance of UAS is exemplified by the increased flying hours of the MQ-1 Predator. The Predator accumulated 250,000 flying hours on June 22, 2007, 12 years after becoming operational, but surpassed 300,000 flying hours six months later and is expected to surpass 500,000 flying hours before the end of 2009 [5].

In the past, UAS advocates gave minimal consideration to survivability with the view being that UAS were to be inexpensive and expendable. Most existing unmanned aircraft (UA) are likely designed to be simple [6], require minimal number of components, and be as light as possible. Fuel tanks are typically non-self-sealing, as such tanks are heavier. UAs are not equipped with fire detection and suppression systems, and most parts of UAs are not ballistic-hardened as this increases cost and weight, and reduces range and endurance.

From 1991 to 2003, 185 UA losses were recorded, an average of 14.2 per year. Of these, 18 RQ-2 Pioneer UAs were lost in combat during Desert Storm (1991) over a

period of less than a year while another two were lost due to non-combat reasons in the same period. During Operation Allied Force (1999), 26 UAs of various types were lost to hostile fire. UA loss rates during Operation Enduring Freedom (OEF) and Operation Iraqi Freedom (OIF) were an average of 2.0 combat losses per year over the 2001-2003 period [7].

From 1990 to 2002, 17 U.S. Air Force (USAF) aircraft were lost in combat. Of these, 14 were lost during Desert Storm, three were lost during Operation Allied Force, and no aircraft lost during OEF and OIF [8]. When these figures are compared with those of UAs, a stark difference can be observed. There is no doubt that with human crew onboard, the emphasis on manned aircraft survivability is much greater than that for unmanned aircraft. For example, the USN requires all its modern aircraft to have more than one engine to ensure their survivability over large open waters, but in the case of Unmanned Combat Aircraft Systems (UCAS), however, the USN has no such requirement.

As the dependence of modern warfighting units on UAS increases, the consequences of occasional losses have become more severe. A unit may lose track of the high-value target it is following if the data link between the UA and its ground control station is jammed. Thus, important intelligence cannot be gathered before the ground force engage its adversary as reconnaissance data from the UA has been denied.

Also with the high unit cost of UAS, UAS can no longer be considered inexpensive. A MQ-1 Predator UAS (includes four aircraft, ground control stations, and Predator Primary Satellite Link) costs \$30.5 million (fiscal 1997 dollars) [9]. Each loss has become more expensive and unaffordable in both operational and monetary sense. Survivability should be included in UAS design, with minimal cost and penalty to the performance of UAS.

A survivability study sponsored jointly by the U.S. National Defense Industry Association and the U.S. Navy supported the need for survivability considerations in UAS design. The study showed that savings in survivability would outweigh cost of fitting systems with survivability features [10]. However, as many existing UAS are

designed without any (or minimal) consideration for survivability, there is a need to enhance the survivability of these systems.

## **B. PURPOSE**

Following a systems engineering methodology, this thesis explored how combat survivability of existing UAS can be enhanced by (1) examining the weaknesses of UAS (with reference to combat survivability), and (2) what combat survivability enhancement options are available. It also proposed a process for selecting the “best” solution from survivability enhancement alternatives.

Even with the focus on existing UAS, many of the solutions identified can also be applied to future UAS survivability designs. As many survivability advocates have observed, it is less expensive to build survivability in the initial design than to retrofit.

The emphasis is to make UAS survivable in a man-made hostile environment (combat survivability), with the focus on preventing the adversary from killing UAS.

## **C. RESEARCH QUESTIONS**

Research questions were used to guide the research. This thesis addressed the following questions:

- What are the survivability enhancement concepts?
- What are the weaknesses of UAS (with reference to combat survivability)?
- How does one enhance combat survivability of an existing UAS?

## **D. SCOPE**

The thesis was scoped to combat survivability of existing UAS. Combat survivability is defined as the capability of a system, including its crew, to avoid or withstand a man-made hostile environment. As surviving implies not getting killed, this thesis will focus on how the adversary can be prevented from killing UAS even though there are many ways for the adversary to affect mission effectiveness without killing UAS.

## **E. METHODOLOGY**

The methodology used to develop this thesis was based on the systems engineering (SE) process. A generic SE process from the fourth edition of Systems Engineering and Analysis by Blanchard and Fabrycky (2006) was adapted to guide this work. Beginning with the stated need to protect expensive, important UAS; the problem (focus of this thesis) was defined; then a functional analysis was performed to identify and partition system functions. The following discussion outlines the eleven-steps methodology.

### **1. Define Problem**

The problem studied in this thesis centered on enhancement of combat survivability of existing UAS. The premise was that combat survivability of existing UAS can be enhanced. While this thesis included the entire UAS for research, the emphasis was primarily on the unmanned aircraft (UA) as, due to the nature of its missions, it is most frequently exposed to the adversary.

### **2. Functional Analysis of Adversary Wanting to Affect UAS Mission Effectiveness**

This is the first step to understanding combat survivability. The objective of an adversary is to affect mission effectiveness of UAS. A functional analysis was performed to discover the system functions that affected combat survivability of UAS.

### **3. Develop the Kill Chain**

Among the many functions the adversary can perform to affect UAS mission effectiveness the most provocative is to kill UAS. A functional analysis was performed to identify functions required in order to kill UAS. In particular, these functions formed the functional kill chain. The functional kill chain is defined as the sequence of functions involved in the successful prosecution of operations that are impacted sufficiently to result in the complete degradation of mission capability [11]. If the functional kill chain is broken, the UAS will not be killed. The kill chain was, therefore, used as the basis to perform the functional analysis on enhancing combat survivability.



#### **4. Perform a Functional Analysis on Enhancing Combat Survivability of UAS**

A functional analysis on enhancing combat survivability of UAS was performed to identify the functions required to enhance combat survivability (i.e., reduce the probability of kill). Functions that disrupt the kill chain are also functions that can enhance combat survivability.

#### **5. Define Concepts that Can Be Used to Achieve Combat Survivability**

Concepts that can be used to achieve combat survivability were then developed from combat survivability enhancement functions identified earlier. The concepts are top-level design principles that can achieve the combat survivability functions identified earlier. These concepts were used to aid the identification of survivability enhancement options later in the research.

#### **6. Perform Physical Decomposition of UAS**

A physical decomposition of UAS was performed to identify the corporeal components of a UAS. Many of these components offer emissions, reflections, or interactions with other objects which may provide signatures that can be exploited by the adversary to detect, identify, and track UAS. Any degradation in these components may also degrade the mission, which in turn may even lead to the destruction or complete degradation of parts or subsystems (or possibly the entire UAS). Results from the decomposition were used to identify UAS weaknesses.

#### **7. Perform Functional Analysis of the Top Priority Mission**

Surveys from combatant commanders (COCOM) and military departments identified the top priority mission by the Office of the Secretary of Defense (OSD). The mission was used as a proxy to understand the functions required to perform UAS operations. A functional analysis of the top priority mission (reconnaissance) was performed to identify the major functions that must be performed. Even though this functional analysis was based on a single UA performing this mission, many of the

functions identified are also applicable when UAS is performing other mission types. Any degradation in these functions can limit UAS performance which may lead to the destruction of parts of UAS, or possibly the entire UAS.

## **8. Identify Potential Threats to UAS**

In order to design the right combat survivability enhancement for UAS, potential threats were identified. This was done by postulating scenarios and identifying and extracting the threats to the entire UAS or its subsystems.

## **9. Identify UAS Weakness (With Reference To Combat Survivability)**

UAS components were combined with system functions and the threats to identify UAS weaknesses (in terms of combat survivability). Components were identified from physical decomposition, functions were described through functional analysis of the top priority mission, and threats were characterized from scenarios. UAS components and functions that can either be exploited by threats to detect UAS, or when disrupted will result in UAS being destroyed, are UAS weaknesses. If the weaknesses are ameliorated or eliminated, combat survivability of UAS can be improved.

## **10. Determine Survivability Enhancement Options**

Using combat survivability enhancement concepts, survivability enhancement options were determined. Due to the wide-ranging characteristics of UAS, no “one size fits all” solution<sup>2</sup> is available. The pros and cons of these options were discussed.

## **11. Develop Selection Process**

While enhancing the combat survivability of UAS, a balance between UAS survivability and satisfying its other requirements (mission requirement, being inexpensive, etc.) must be maintained. A process is required to help select the “best” combat survivability enhancement solution. A selection process based on SE methodology was proposed at the end of this thesis.

---

<sup>2</sup> A combat survivability enhancement solution may consist of more than one enhancement option.

## **F. THESIS FLOW**

The thesis consists of eight chapters. Chapter I provides the background of this thesis, along with the scope and methodology used. Chapter II discusses what combat survivability is and identifies combat survivability enhancement concepts. Combat survivability enhancement options identified later in the thesis are based on these concepts.

Chapter III provides an overview of UAS and identifies the top priority UAS mission and functions required to perform the mission. Chapter IV identifies potential threats to UAS. Chapter V identifies and discusses UAS weaknesses (with reference to combat survivability). These weaknesses are to be ameliorated or eliminated by the combat survivability enhancement options identified in the next chapter.

Chapter VI identifies and discusses the combat survivability enhancement options available. The chapter also discusses the possibility of a “one size fits all” solution to enhance combat survivability of existing UAS. Chapter VII proposes a selection process that can be used to determine the need to enhance the survivability of an existing UAS and select an enhancement solution once the need is established. It also includes an example to illustrate the process.

Chapter VIII concludes the thesis.

## **G. CHAPTER SUMMARY**

This chapter provided the rationale and overview of the thesis as well as the scope, benefits, and research methodology.

## II. COMBAT SURVIVABILITY

### A. SURVIVABILITY, SYSTEM SAFETY, AND COMBAT SURVIVABILITY

Robert E. Ball, in his book *The Fundamentals of Aircraft Combat Survivability – Analysis and Design, Second Edition*, defines survivability as the capability of a system to avoid or withstand hostile environments. This definition includes both man-made and naturally occurring environments, such as lightning strikes, severe turbulences, and crashes [12]. The system safety discipline aims to minimize conditions (also known as hazards) that can lead to mishaps in natural or normal environments. When applied together, the system safety and survivability disciplines attempt to maintain safe operation and maximize the survival of a system in all environments, in both peacetime and wartime [13].

Combat survivability has a tighter definition than survivability. Combat survivability is defined as the capability of a system, including its crew, to avoid or withstand a man-made hostile environment. Combat survivability is a function of both susceptibility and vulnerability. Susceptibility is loosely defined as the inability of a system to avoid being hit in a hostile environment, whereas vulnerability is the inability of the system to withstand damage caused by the threat. The system is killed when it is hit and unable to withstand damage from that hit. Susceptibility and vulnerability can be measured by the probabilities of these events happening. The probability of a system being killed (also known as “killability”) is therefore the product of the probability of the system being hit and the probability of the system succumbing to the damage. Mathematically,

Probability of system surviving a hostile environment (combat survivability) = 1 – Probability of the system being hit (susceptibility) x Probability of the system succumbing to the damage (vulnerability). Figure 4 shows the relationship between combat survivability, survivability, and system safety. The focus of this thesis is on combat survivability.

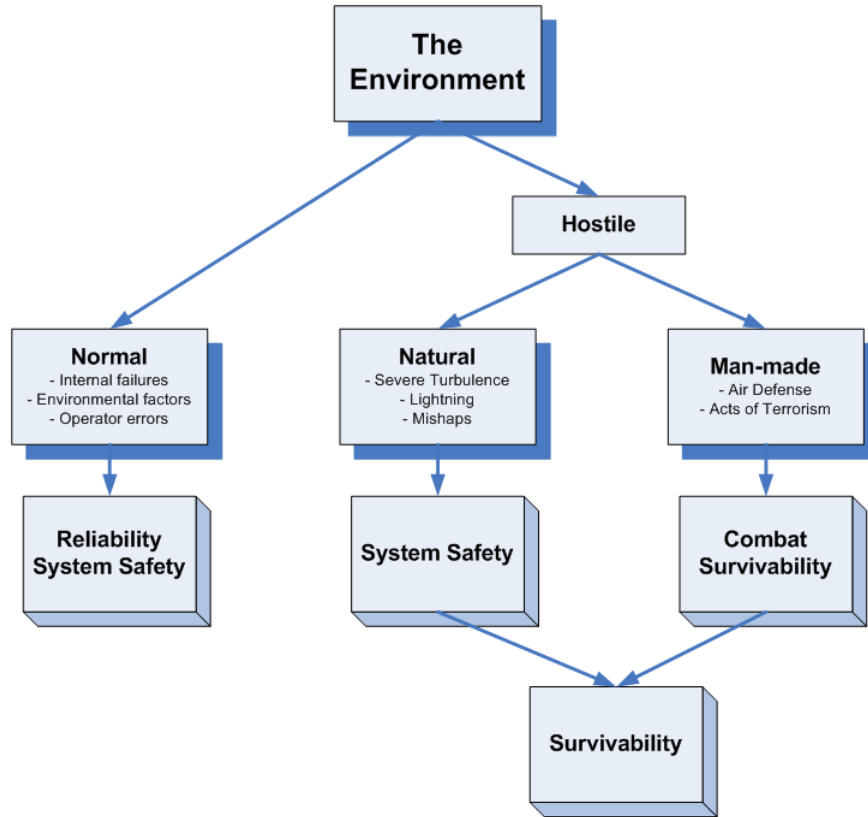

Figure 4. Relationship Between Combat Survivability, Survivability, and System Safety [After 12].

## 1. Susceptibility

The inability of a system to avoid being hit in a hostile environment is referred to as susceptibility [13]. The more likely the system will be hit by one or more damage mechanisms<sup>3</sup> generated by a threat weapon, the more susceptible the system is. Susceptibility is measured by the probability of the system being hit.

---

<sup>3</sup> Damage mechanism is the physical output of a weapon that causes damage to the target. Examples of damage mechanisms for a warhead include metallic penetrators and fragments, incendiary particles, and air blasts [13].

Susceptibility can be influenced by the following:

- Threat level (dependent on, for example, threat capability and number of threats)
- System design (for example performance, agility and system signature)
- Utilization of survivability equipment (for example, countermeasures and threat warning)
- Tactics employed (for example, Suppression of Enemy Air Defense and flying Nap-of-the-Earth)

## **2. Vulnerability**

The inability of a system to withstand damage caused by a damage mechanism is referred to as vulnerability [13]. The more likely the system will be killed from the hit by the damage mechanism generated by a threat weapon, the greater the vulnerability of the system. Vulnerability is measured as the probability of system kill given a hit.

Vulnerability can be influenced by the following:

- Lethality of threat weapon (for example, fragment size, blast energy)
- System design and architecture (for example, location of components, redundancy)
- Utilization of survivability equipment (for example, damage suppression)

## **B. ADVERSARY'S OBJECTIVE**

The objective of an adversary is to reduce the effectiveness of UAS. To understand how the adversary will reduce the effectiveness, a functional decomposition is performed. The functional decomposition of the adversaries' top requirement, i.e., "Reduce UAS Effectiveness" delineates the possible modes of disruption that can reduce the mission capabilities of UAS. The defining levels of reduction are shown in Figure 5.

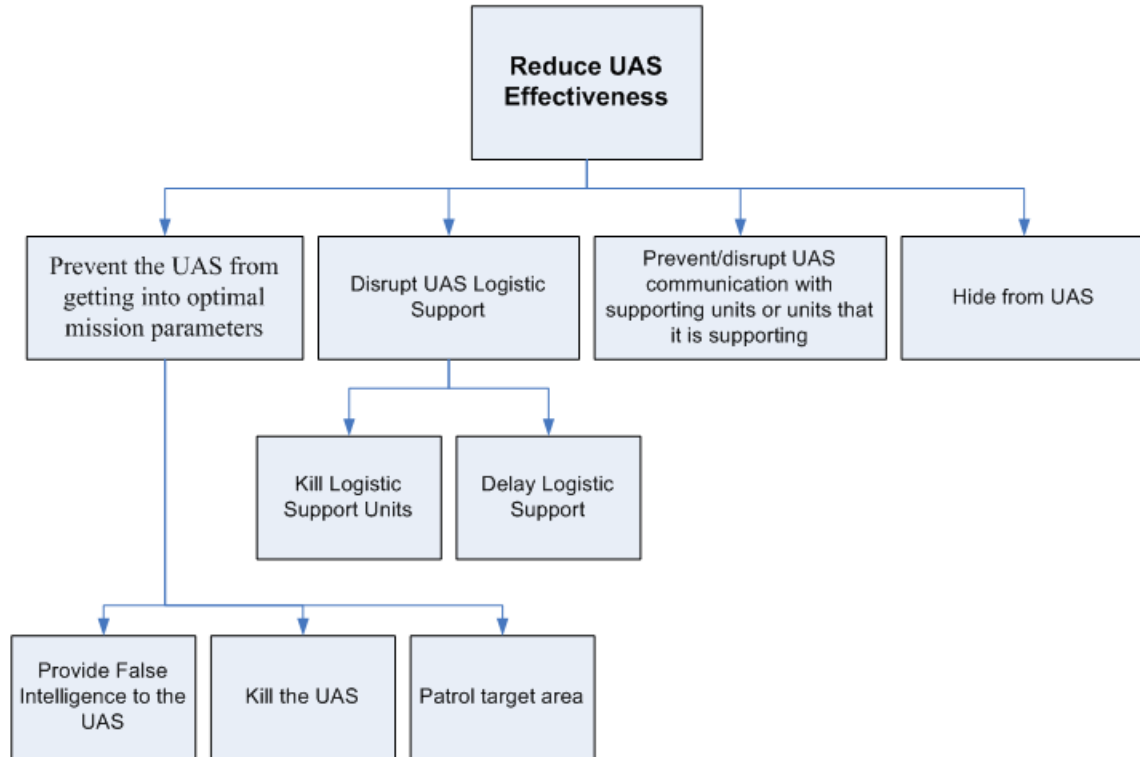

Figure 5. Functional Decomposition of Adversary Reducing UAS Effectiveness.

As shown in Figure 5, the adversary can hide from UAS such that it cannot be located by the UAS. As long as the UAS cannot locate the adversary, it cannot perform its mission. The adversary can also prevent or disrupt the communication between the UAS and its supporting units or units it is supporting such that it cannot obtain important information required for its mission. For example, if UAS is not able to communicate with the intelligence unit that is supporting it, the UAS commander may not be able to plan a flight route that keeps the UA safe from the adversary’s air defense. The adversary can thus shoot down the UA before it reaches its target area.

The adversary can also disrupt UAS logistic support such that UAS cannot perform its mission. For example, if the unit transporting the fuel is killed before the fuel arrives at the UAS, the UA may not have the fuel required to perform its mission.

Another way the adversary can reduce effectiveness of UAS is to degrade its optimal mission parameters. The adversary could patrol the target area in order to deny access to the UA. By broadcasting false intelligence the adversary can ‘trick’ the UAS commanders into flying the UA to a different area. The adversary can even attack and kill UAS.

The last sub-function is of particular interest, as making UAS survivable in a man-made hostile environment (combat survivability) is to prevent the adversary from killing UAS. This thesis is primarily concerned with preventing the adversary from killing UAS.

### **C. ENHANCING COMBAT SURVIVABILITY**

The single-shot kill chain starts from the adversary 1) deploying the threat sensor and becoming active and searching for UAS. It is followed by 2) the sensor detecting UAS, identifying, and classifying the target. The adversary will then 3) work out a firing solution, and 4) launch the threat propagator<sup>4</sup> when ready. The threat propagator will intercept UAS and 5) the damage mechanism from the threat propagator will be enacted. UAS is killed when 6) the damage mechanism overcomes UAS resistance or tolerance to destruction. Figure 6 illustrates the kill chain. A similar kill chain applies to multiple-shot scenario. In a multiple-shot scenario, events from three to six may occur multiple times.

---

<sup>4</sup> The object that propagates the threat. Gun-fired ballistic projectile from a gun or guided missile are examples of treat propagator.



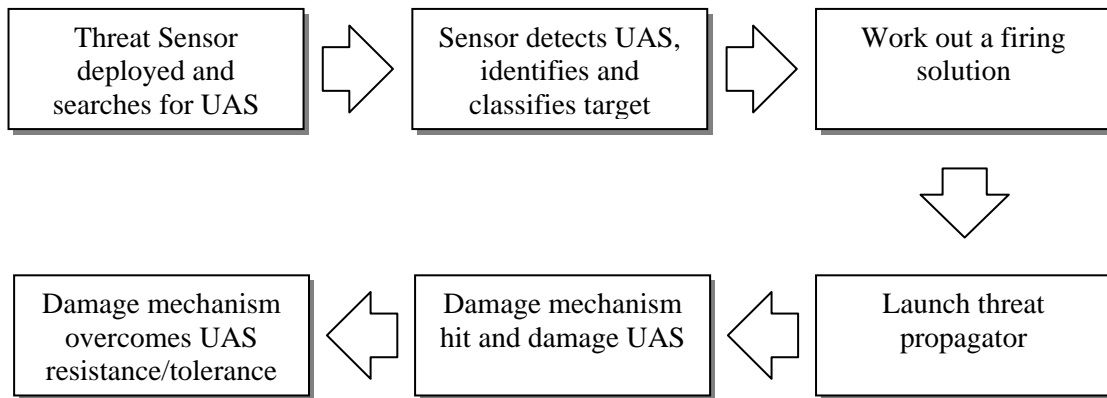

Figure 6. A Single Shot Kill Chain to Kill A UAS.

Combat survivability can be enhanced by reducing the probability of any of the six events of the kill chain from happening. For example, if the threat sensors are prevented from deploying, they cannot become active and therefore will not be able to detect UAS, much less kill UAS. Also, if the damage mechanism cannot hit UAS, the UAS will not be killed. Likewise, if the damage mechanism cannot overcome UAS resistance to damage, it cannot kill UAS. Reducing susceptibility of UAS reduces the probability of the first five events of the kill chain from happening while reducing vulnerability reduces the probability of the last event from happening.

Features that reduce susceptibility and vulnerability can be installed to perform functions that reduce susceptibility or vulnerability (and consequently enhance survivability). A functional decomposition of enhancing combat survivability was performed to identify these functions. This is presented in Figure 7.

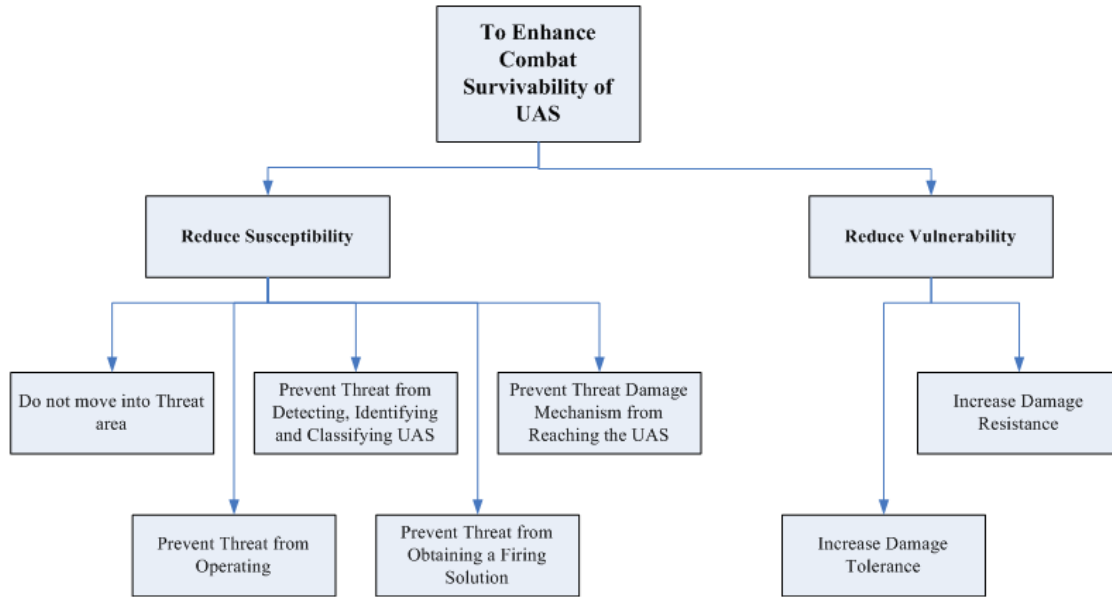

Figure 7. Functional Decomposition of “To Enhance Combat Survivability of UAS.”

There are seven general functions fundamental to survivability enhancement. These were expanded into concepts and applied to reduce susceptibility or vulnerability and listed in Table 1. Each of these functions could be achieved by numerous other sub-functions or concepts. These concepts produce survivability enhancement options that can counter the threats (identified in Chapter IV). These options were considered to improve existing UAS. See Chapter VI.

Table 1. Survivability Enhancement Functions

FUNCTIONS	ACHIEVED BY
<b>Reduce Susceptibility</b>	
Do not move into threat area	<ul style="list-style-type: none"> <li>• Gather intelligence about threat</li> <li>• Warn about presence of threat</li> <li>• Increase stand-off range</li> <li>• Improve system performance</li> </ul>
Prevent threat from operating	<ul style="list-style-type: none"> <li>• Suppress threat</li> </ul>
Prevent threat from detecting, identifying, and classifying UAS	<ul style="list-style-type: none"> <li>• Reduce signature of UAS</li> <li>• Jam/deceive sensor</li> <li>• Enhance tactics and training</li> <li>• Improve system performance</li> </ul>
Prevent threat from obtaining a firing solution	<ul style="list-style-type: none"> <li>• Reduce signature of UAS</li> <li>• Jam/deceive sensor</li> <li>• Enhance tactics and training</li> <li>• Improve system performance</li> </ul>
Prevent threat damage mechanism from reaching UAS	<ul style="list-style-type: none"> <li>• Reduce signature of UAS</li> <li>• Jam/deceive sensor</li> <li>• Distract threat propagator using expendables</li> <li>• Enhance tactics and training</li> </ul>
<b>Reduce Vulnerability</b>	
Increase damage tolerance	<ul style="list-style-type: none"> <li>• Suppress damage</li> <li>• Install redundant components (with separation)</li> <li>• Locate critical components in a way that reduce probability of the damage from killing UAS</li> </ul>
Increase damage resistance	<ul style="list-style-type: none"> <li>• Shield critical components</li> <li>• Eliminate components</li> </ul>

## **1. Reducing Susceptibility**

Reducing susceptibility results from reducing the likelihood that the UAS will be hit in a hostile environment. This reduction can be achieved by destroying or degrading (1) the threat's capability to search for UAS, (2) detecting, identifying and classifying the UAS, (3) tracking and firing at the system, and (4) reducing the threat propagator's likelihood of hitting the UAS (refer to Figure 6). The susceptibility reduction concepts listed in Table 1 can be used to destroy or degrade a threat's capability.

### ***a. Gather Intelligence about Threat***

Intelligence about the threat allows UAS commanders to better plan the mission to avoid or minimize contact with the threat. For example, with the knowledge of adversary air defense emplacement, the commander can plan the UA's flight route beyond the range of the adversary's air defense radar search capability. However, as the core function of gathering intelligence about the threat is performed by intelligence agencies beyond the purview of UAS, no further discussion will be presented in this thesis.

### ***b. Threat Warning***

Threat warning improves situational awareness. Situational awareness involves the operator being aware of what is happening and understanding how the events and his actions will impact mission objectives. If the system operator is made aware of the threat situation, he or she can adopt appropriate actions to reduce the likelihood of their UA being hit in a hostile environment. For example, the knowledge of location, status and the capabilities of adversary's threat system allows one to plan the mission around these threats. The operator may launch countermeasures to thwart an approaching hostile.

Equipment which embodies concepts that enable threat-warning includes Radar Warning Receivers (RWR), Missile Approach Warning Systems (MAWS), and an Airborne Warning and Control System (AWACS, e.g., E-3 Sentry).

*c. Increase Stand-off Range*

Payload capabilities have great impact on system survivability. For example, a camera payload with a greater detection range allows the UA to survey the target area at a greater stand-off range without putting itself in danger. Greater payload capability improves survivability.

*d. Improve System Performance*

Improving system performance (speed, altitude, maneuverability, and agility) reduces susceptibility through system design. The RQ-4 Global Hawk is designed to fly at 65,000 feet to minimize its exposure to most surface-to-air missiles (SAM). Design of the RQ-4 is an example of reducing susceptibility through system performance.

Reducing the UA speed to below the radar velocity gate may prevent the adversary from using his radar to detect the UA, thus improving its survivability.

*e. Threat Suppression*

Threat suppression refers to the act of putting down threats through force. It consists of actions to damage or destroy the threats. This can be accomplished by the system firing self-defense weapons (like missiles, guns, or even inexpensive mini-unmanned aircraft that will sacrifice themselves by ramming into the attacking threat) or having friendly supporting elements eliminate the threat. Examples of threat suppression include artillery bombardment of the threat area, suppression of enemy air defense (SEAD), and taking over control of the threat system. The elimination of threat reduces the susceptibility of the system to the threat to zero.

*f. Signature Reduction*

Threat systems typically detect, identify, and track its target using one or more the following eight sources of signatures: 1) radar echo, 2) infrared radiations, 3) visual radiation, 4) acoustic pressure, 5) magnetic fields, 6) gravitational anomalies, 7) electrostatic fields, and 8) scalar anomalies. Reducing the detectability of these

signatures may degrade the ability of the threat system to detect the target. These actions include reducing UAS signatures to levels lower than the threat sensor's thresholds and reducing the system signatures to levels such that the system's contrast with its background is low [13].

Table 2 contains some examples of UAS signature reduction methods.

Table 2. Some Signature Reduction Method.

<b>Signature</b>	<b>Reduction Method</b>
Radar Echo	<ul style="list-style-type: none"> <li>• Reflect the radar signal away from receiving antenna</li> <li>• Absorb the radar signal by attenuation or interference</li> </ul>
Infrared Radiation	<ul style="list-style-type: none"> <li>• Reduce the temperature of hot components</li> <li>• Reduce the temperature of exhausts</li> <li>• Reduce or mask surface radiating areas</li> </ul>
Visual Radiation	<ul style="list-style-type: none"> <li>• Camouflage</li> <li>• Reduce glitter</li> </ul>
Acoustic Pressure	<ul style="list-style-type: none"> <li>• Direct acoustic pressure away from threat sensors</li> <li>• Reduce power level of noise</li> </ul>

***g. Jamming and Deceiving***

These refer to a form of electronic warfare. Some Electronic Attack (EA) equipment such as jammers and decoys can be utilized to prevent detection of the system by adversary's radars or to send out bogus signals to confuse or break radar lock from a tracking system, thereby preventing an engagement that results in damage.

Equipment that enables noise jamming and deceiving concepts includes the AN/ALQ-131 Self Protection Jammer Pod (used by F-16, F-111, A-10 aircraft, etc.), the ALE-50 Active Towed Decoy, and the SPJ-40 ECM Jammer (an internally mounted jammer by ELISRA).

#### ***h. Tactics and Crew Training and Proficiency***

Tactics are about how units are employed. Tactics that minimize exposure of a system to threat, while still achieving the mission objectives, reduce the system susceptibility. For example, the UA can fly higher than 15,000 feet to avoid hits by an adversary's anti-aircraft artillery (AAA).

Crew training & proficiency will determine how well a mission is executed, how the system will react when a threat is discovered, etc. It can be expected that a UAS operated by a proficient crew will survive longer in combat than one that is less competent; therefore it is important that a crew has proper training which increases their proficiency.

#### ***i. Expendables***

Robert E. Ball defines *expendables* as materials or devices designed to be ejected from a system for the purpose of denying or deceiving threat tracking systems for a limited period of time [13]. These expendables can be used to draw the threat propagator away from the UA, thus preventing the damage mechanism from reaching the UA. Examples of expendables include chaff, Active Towed Decoy Systems, flares, and aerosols (e.g., smokes and fogs).

### **2. Reducing Vulnerability**

Reducing vulnerability is about reducing the likelihood a system is killed after it is hit by a damage mechanism in a hostile environment. Vulnerability involves improving fault tolerance, hardening, and/or damage suppression of critical components, so as to control or minimize the amount of consequence of the damage to the system caused by the damage mechanism. In short, the aim of vulnerability reduction is to reduce the likelihood of critical system components being killed after the system is hit. The vulnerability reduction concepts were listed in Table 1 and are discussed in detail in the following subsections.

***a. Damage Suppression***

Damage suppression can be broadly classified into passive and active. Passive damage suppression incorporates in the system design features that can contain or reduce the effectiveness of damage mechanisms. Being passive, these features have no damage-sensing capabilities [13]. Passive damage suppression includes damage tolerance, ballistic resistance, delayed failure, leakage suppression, fire and explosion suppression, and fail-safe response. An example of passive damage suppression is a self-sealing tank where the tank is surrounded by one or more layers of sealant (such as uncured rubber). When the tank is punctured, exposure of the sealant to the fuel will result in a swelling of the sealant and closure of the wound.

Active damage suppression incorporates features that, upon sensing that damage has occurred, will activate functions that can contain or reduce the effectiveness of damage mechanisms. An example of active damage suppression is a fire detection and extinguish system. Upon the detection of fire, the system will automatically dispense fire-inerting gas or liquid to put out the fire.

***b. Component Redundancy (With Separation)***

Redundancy is the employment of more than necessary components in the system. Similar or same sets of components performing identical functions are said to have actual redundancy. An example is the Boeing B-777 aircraft having two engines when only one is required to fly. On the other hand, the use of different sets of components to perform the same function is said to have functional redundancy. An example is the Global Hawk equipped with both Electro-Optics (EO) and Synthetic Aperture Radar (SAR) for imaging functions.

In order to effectively reduce vulnerability, these redundant components are to be separated physically too. This is to minimize damage to all components when an area is hit. Component redundancy without separation only increases system reliability, but not survivability.



*c. Component Location*

Locating components in a manner so as to reduce the probability of a damage mechanism from killing the system is another vulnerability reduction concept. This includes placing critical components away from weak spots, placing a non-critical component in front of (i.e., shielding) a critical component, and orienting critical components in such a way that minimal area is presented to threat. The A-10 Close Air Support aircraft applies this concept by locating both its engines high on its fuselage so that the area presented to AAA is minimal.

*d. Component Shielding*

Component shielding is achieved by covering/surrounding the critical component with another material that is able to reduce or absorb the impact of the damage mechanism. The use of armor to protect the crew in a tank is an example of component shielding.

*e. Component Elimination or Replacement*

Component redundancy mentioned earlier improves survivability but at the expense of increasing requirements for maintenance. This is because there are now more components to maintain. Another way to reduce vulnerability is to eliminate the component or to replace it with a less vulnerable component that performs the same function. This arguably may be a better approach than component redundancy. An example is replacing mechanical control rods and linkages with multiple and separated wires in fly-by-wire aircraft. The wires present smaller areas as compared to the rods and linkages, therefore reducing the likelihood of being damaged by a hit.

**D. CHAPTER SUMMARY**

Combat survivability is defined as the capability of a system, including its crew, to avoid or withstand a man-made hostile environment. To enhance combat survivability, susceptibility and/or vulnerability of UAS has to be reduced. Numerous susceptibility and vulnerability reduction concepts have been identified. Using these concepts, multiple survivability enhancement options can be designed to counter threats.

### III. UNMANNED AIRCRAFT SYSTEM

#### A. OVERVIEW OF AN UNMANNED AIRCRAFT SYSTEM

A UAV (or UA) is defined in Joint Publication 1-02 Department of Defense (DoD) Dictionary as:

a powered, aerial vehicle that does not carry a human operator, uses aerodynamic forces to provide vehicle lift, can fly autonomously or be piloted remotely, can be expendable or recoverable, and can carry a lethal or non-lethal payload. Ballistic or semi ballistic vehicles, cruise missiles, and artillery projectiles are not considered unmanned aerial vehicles.

A basic UAS consists of one or more unmanned aircrafts, ground control station (may include mission planning capability), payload(s), and data link. However, many systems also include launch and recovery systems, unmanned aircraft carriers, and ground handling and maintenance equipment [14]. Figure 8 shows a generic UAS.

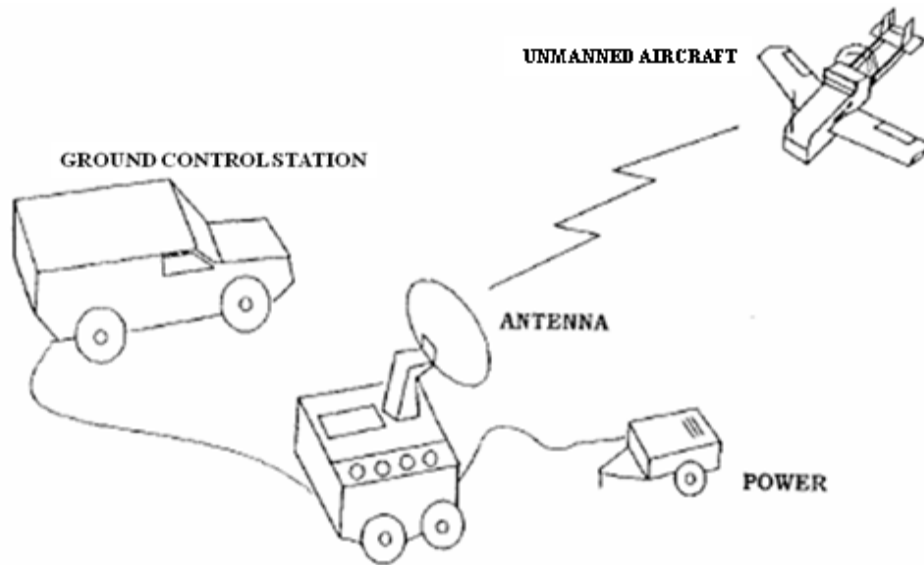

Figure 8. A Generic UAS [From 14].

#### 1. Unmanned Aircraft

The unmanned aircraft (UA) is the airborne component of UAS. It is the executioner's arm of UAS. The UA includes an airframe, propulsion system,

communication/identification system, navigation system, fuel system, electrical system, computer, and automatic flight control system. Refer to Figure 9 for an illustrated look inside a UA example. The UA is very much like an aircraft without the cockpit and follows the same laws of aerodynamics. Payloads are not considered as part of the UA as payloads are interchangeable with different UAs.

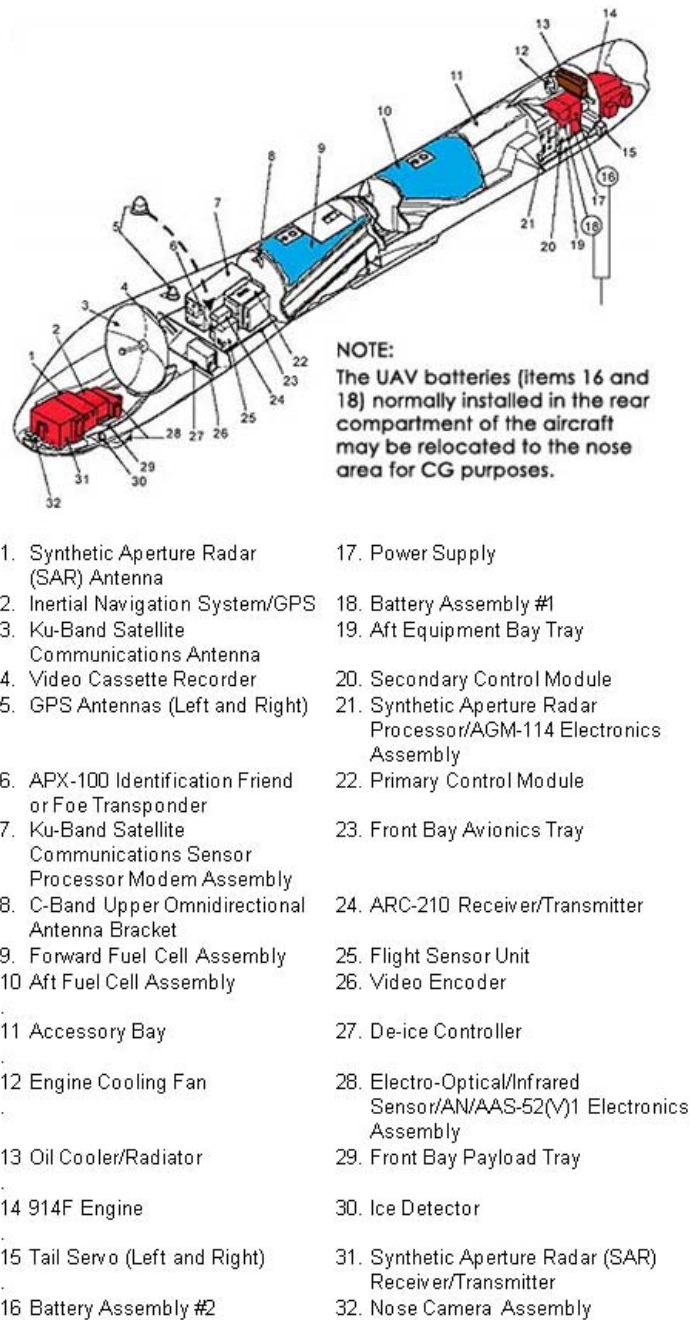

Figure 9. A Look Inside the RQ-1 Predator [From 15].

Some of the more commonly known examples of UAs include the RQ-1 Predator, RQ-2B Pioneer, RQ-4 Global Hawk, RQ-5A Hunter, Skylark, FanTail 5000, Boeing ScanEagle, Searcher II, Hermes 450, and Heron.

## 2. Ground Control Station

The ground control station (GCS) is the operational center (the brain) of UAS. The GCS is where video images as well as command and telemetry data from the unmanned aircraft are processed and displayed. The size of the GCS can range from as large as a shelter to as small as a handheld computer (as shown in Figure 10).



Figure 10. A Handheld Computer Serving as the Ground Control Station for the Skylark Mini UAV [From 16].

To serve its role as the operational center, a GCS typically consists of control and display consoles, video and telemetry instrumentation, computation and signal processing equipment, and ground data terminal. Larger GCS (with shelter) also include environmental control systems and survivability protection equipment. Some GCS may also include facilities for mission planning.

The GCS may also be where the mission commander plans the mission, receives mission assignments from supported units, and reports acquired data and information to the appropriate units (the customers). A larger station typically also has positions for both the unmanned aircraft and mission payload operators to perform their respective functions.

A cut-away view of a typical sheltered GCS is shown in Figure 11. As can be seen from the depiction, the shelter houses computers, monitors and telemetry equipment for controlling the UA, a radio set to communicate with supported units, and a work table for mission planning.

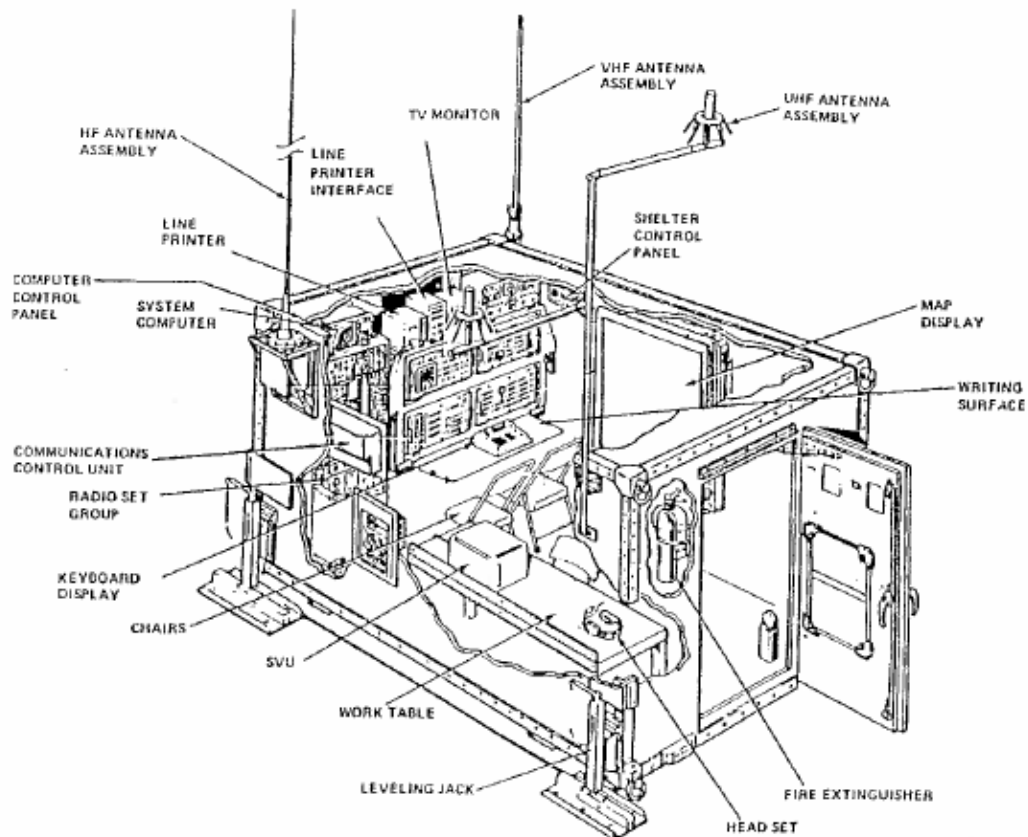

Figure 11. A Typical Ground Control Station [From 14].

### 3. Launch and Recovery System

A number of techniques can be used to launch and recover UAs. Smaller UAs can be launched by simply throwing them into the air, or slinging them into the air using bungees, thereby eliminating the need for complex launch and recovery systems. Larger UAs, on the other hand, need to be launched using prepared sites (such as runways), catapults, or air launched.

A UA can be recovered by landing on prepared sites, captured by nets or arresting gears (for point recoveries in small areas), or simply fall out of sky and break into large pieces (and rejoined easily for the next mission).

For larger UA, there is usually a separate control station dedicated to launch and recover the UA. This separate station communicates with the UA through line-of-sight (LOS) instead of through satellite. The delays in communication through a satellite relay may be too long to facilitate the quick reactions required during the critical moments of taking off and landing. There is minimal delay in LOS communications.

Figure 12 below shows a ScanEagle launching from its catapult launching system.



Figure 12. ScanEagle Launched Using A Catapult [From 7].

#### **4. Payloads**

Payloads are usually the “eyes and ears” of UAS. The ultimate purpose of a UAS is to carry payload. The payload is also usually the most expensive equipment onboard a UA. For example, the Integrated Sensor Suite (ISS) installed in the RQ-4 Block 10 Global Hawk represents over 33 percent of the aircraft’s total cost, while the sensor package to be installed into the RQ-4 Block 20 is estimated to represent 54 percent of the aircraft’s total cost [7].

Payloads often include video cameras, either daylight or night (infrared), and depending on the mission, may also include radar sensors (Moving Target Indicator and Synthetic Aperture Radar, SAR) for reconnaissance missions, full spectrum of signal intelligence (SIGINT) and jammer equipment for electronic warfare (EW) missions, meteorological and chemical sensing devices for other non-lethal missions. When the USAF decided to weaponize the RQ-1 Predator to carry AGM-114 Hellfire missiles, munitions such as bombs and missiles became another type of payload for a UA.

As important as payloads may be, payloads typically account for only 10 to 20 percent of a UA’s gross weight [7]. This is mainly due to the desire for endurance in many UAs, resulting in a high fuel fraction and a corresponding low payload fraction.

#### **5. Data Links**

The data link is a key subsystem for any UAS that provides the linkage between the GCS and its UA from some distance away. The data link can provide either on-demand or continuous two-way communication. An up-link for transmitting commands to control the unmanned aircraft or its payload typically has a data rate of a few kHz. The down-link, on the other hand, provides both a low data rate channel and a high data rate channel (1 to 10 MHz) [14]. The low rate channel is used to acknowledge commands and transmit unmanned aircraft and payload status information, while the high rate channel is used to transmit images or sensor data from the payload. This is summarized in Figure 13.

Other than communication, the data link can also be used to determine unmanned aircraft position by measuring its azimuth and range from the GCS antenna. Knowledge of this relative position not only aids navigation of the unmanned aircraft, but can also be used to determine target location.

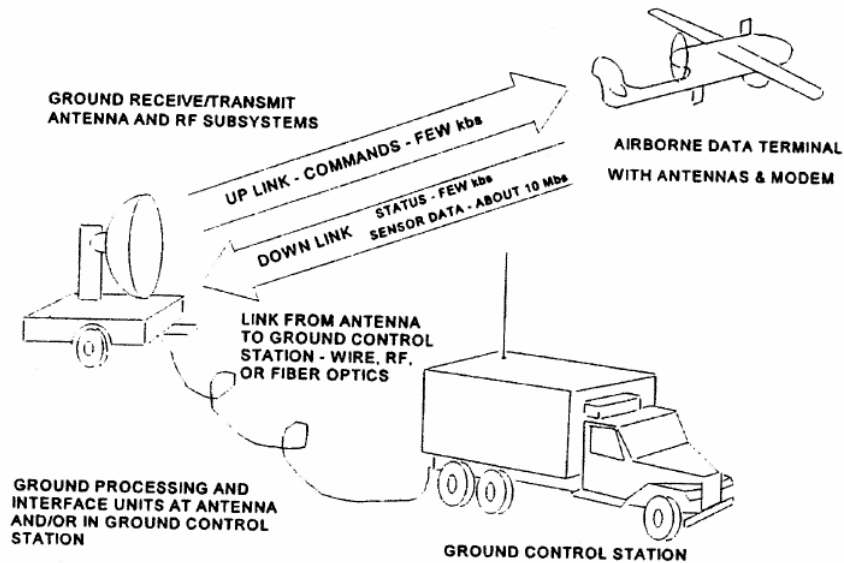

Figure 13. Elements of a UAS Data Link [From 14].

The data link typically utilizes microwave technology to provide communications between the GCS and the UA. It consists of a ground-based data terminal and an airborne data terminal. The communication is either through line-of-sight (LOS) or via satellite (if over the horizon).

The ground data terminal is either co-located with the GCS shelter or remotely positioned. In the case of a remote location, the terminal is typically connected to the GCS by hard wire such as fiber-optic cables (the EL/K-1861 ground data terminal, as shown in Figure 14 can be connected to the GCS, up to 5 kilometers away, using one or two optical cables). As the signal transmission has a tendency to radiate rather openly and draw fire, locating the data terminal away from the GCS reduces the likelihood of the GCS being hit by enemy fire.





Figure 14. A Ground Data Terminal – EL/K-1861 [From 17].

The ground terminal transmits flight control and payload commands, and receives flight status information (altitude, speed, direction, etc.) and mission payload sensor data (video imagery, target range, lines of bearing, etc.).

Additional ground terminals may also be co-located with the users of sensor data. One example is the Remotely Operated Video Enhanced Receiver (ROVER) system [18]. In such cases, the users likely will have the capability to only receive data but not transmit commands to the unmanned aircraft.

The air data terminal includes a video transmitter and antenna for transmitting images and unmanned aircraft data, and a receiver for receiving commands from the ground.

Figure 15 shows the communications architecture of the RQ-4 Global Hawk. As can be seen, the Global Hawk system uses both LOS and satellite communications for the GCS (Mission Control Element and DCGS in the figure) to transmit command to the UA, and for the UA to transmit both status information and sensor data to the GCS and other users.

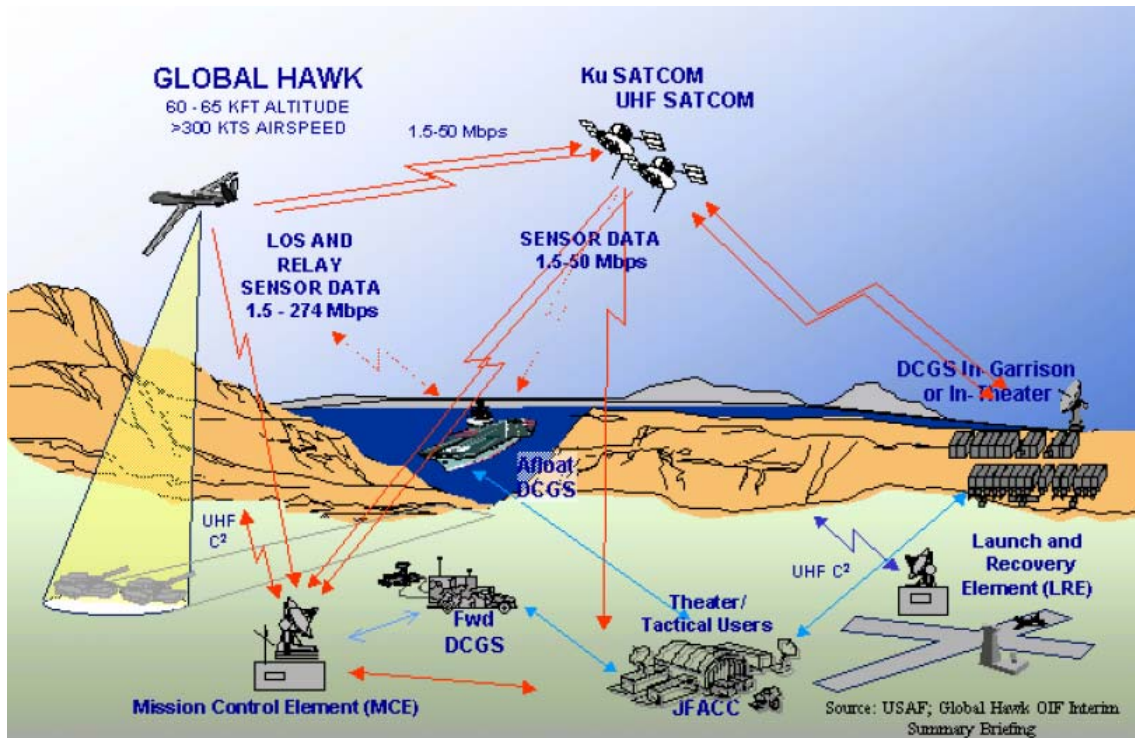

Figure 15. RQ-4 Global Hawk Communications Architecture Showing Various Data Links [From 7].

## 6. Ground Support Equipment

Ground support equipment (GSE) includes test and maintenance equipment, equipment necessary to move the unmanned aircraft about (to place it on a launcher, for instance), a starter motor, auxiliary power units, etc. Often neglected, the GSE is actually an important part of an increasingly complex UAS. Without GSE, the availability of UAS is severely affected.

## 7. Physical Decomposition of UAS

UAS is a very complex system that is made up many subsystems and components. A physical decomposition of a UAS will show the complexity. Many of these components emit signatures that can be exploited by the adversary to detect, identify, and track UAS. Some threat propagators (such as SAMs) launched by the adversary hone-in on these signatures. Any degradation in these components can also degrade the mission

being performed and may even lead to the destruction of parts of UAS, or even the entire UAS. As an example, a UA will be destroyed if its wing is destroyed while in flight.

A physical decomposition of a UAS (with a fixed wing UA) is presented in Figure 16.

<b>Unmanned Aircraft System</b>	
1.0	Unmanned Aircraft (Fixed Wing)
1.1.0	Airframe
1.1.1	Wing, empennage, fuselage, and associated flight control system
1.1.2	Air induction system, exhausts, starters, inlet control system
1.1.3	Lighting gear; tires, tubes, wheels, brakes, hydraulics, etc.
1.1.4	Secondary power (not applicable for most UA)
1.1.5	Environmental control, racks, mounts, intersystem cables and distribution boxes, etc., which are inherent to and non-separable from the assembled structure
1.1.6	Dynamic systems-transmissions, gear boxes, propellers, if not furnished as an integral part of the propulsion unit
1.1.7	Other equipment homogeneous to the airframe
1.2.0	Propulsion
1.2.1	The engine as a propulsion unit within itself (e.g., reciprocating, turbo, or other type propulsion) suitable for integration with the airframe
1.2.2	Transmission, gear boxes and engine control units, if furnished as integral to the propulsion unit
1.2.3	Engine control electronics (hardware and software integral to the propulsion system)
1.3.0	Communications/Identification System
1.3.1	Radio system(s), identification equipment (IFF), Airborne Data Terminal, and control boxes associated with the specific equipment
1.4.0	Navigation System
1.4.1	Radar, radio, GPS, INS or other essential navigation equipment, radar altimeter, direction finding set, Doppler compass, computer, and other equipment homogeneous to the navigation/guidance function
1.5.0	Fuel System
1.5.1	Fuel Management System
1.5.2	Fuel cells
1.5.3	Fuel transfer systems, valves, etc.
1.6.0	Electrical System
1.6.1	Generator
1.6.2	Batteries
1.7.0	Central Computer
1.8.0	Automatic Flight Control System (UA capable of performing autonomous flight)

1.8.1	Flight control computers, signal processors, and data transmitting elements that are devoted to processing data for either primary or automatic flight control functions
1.8.2	Electronic devices required for signal processing, data formatting, and interfacing between the flight control elements; the data buses, optical links, and other elements devoted to transmitting flight control data
1.8.3	Flight control sensors such as pressure transducers, rate gyros, accelerometers, and motion sensors
1.9.0	Auxiliary Equipment
1.9.1	Auxiliary airframe equipment such as external fuel tanks, pods, etc.
1.9.2	Multi-use equipment like antennas, control boxes, power supplies, environmental control, racks, and mountings, not homogeneous to the prescribed WBS elements
1.9.3	De-ice system
1.10.0	Built-in Test System (for fault detection and reporting)
1.11.0	Survivability Features (if already equipped)
1.11.1	Warning devices and other electronic devices, electronic countermeasures, jamming transmitters, chaff, infra-red jammers
2.0	Ground Control System (Sheltered)
2.1.0	UA Data Display and Controls
2.1.1	Aircraft status displays, display control units, display processors
2.1.2	Display/control interfaces; switches, pedals, control grips such as those for the stick/yoke, throttle, cyclic and collective
2.1.3	Aircraft data feed displays; TV monitors, etc.
2.2.0	Mission Planning Equipment
2.2.1	System computers, printer, stationery, etc.
2.2.2	Situation displays, charts, maps, etc.
2.3.0	Communication System
2.3.1	Radio system(s), Ground Data Terminal, and control boxes associated with the specific equipment
2.3.2	Network, computer processing and display hardware such as routers, switches, servers, workstations, storage devices, etc.
2.4.0	Shelter
2.4.1	Cooling systems, chemical/biological protection
2.4.2	Interior/exterior lighting, seat installations, consoles, instrument panels
2.4.3	Tables, chairs
2.5.0	Auxiliary Equipment
2.5.1	Multi-use equipment like antennas, control boxes, power supplies, environmental control, racks, and mountings, not homogeneous to the prescribed WBS elements
3.0	Payload
3.1.0	IMINT Sensors
3.1.1	Electro-Optic Sensor (TV, FLIR), SAR, LIDAR, etc.
3.2.0	COMMINT systems
3.3.0	Communication sets for re-broadcast

3.4.0	CRBN Sensor
3.5.0	Electronic Warfare System
3.5.1	Electronic countermeasures, jammers, electromagnetic deception equipment, or weapons that use electromagnetic or directed energy such as laser, RF weapons, or particle beams
3.6.0	Weapons Delivery
3.6.1	Targeting system
3.6.2	Fire Control Computer and control and safety devices
3.6.3	Launchers, pods, bomb racks, pylons, integral release mechanisms, and other mechanical or electro-mechanical equipments specifically oriented to the weapons delivery function
3.6.4	Armament/Ordnance
3.7.0	Recorder
4.0	Other Ground Elements
4.1.0	Launch & Recovery Systems
4.1.1	Catapult launching system
4.1.2	Arresting nets/lines
4.1.3	Runways
4.1.4	Parachute systems
4.1.5	Bungee cords
4.2.0	Ground Support Equipment
4.2.1	Test & maintenance equipment
4.2.2	Starter motor, auxiliary power unit (APU)
4.2.3	Transport equipment
4.2.4	Fuel tanker

Figure 16. Physical Decomposition of UAS [After 19].

## B. MISSION

UAS are said to be better suited to perform “dull, dirty and dangerous” missions than manned systems.

Dull missions are typically long missions that have little “action” through the duration of the mission. The longest USAF B-2 bomber sortie during Operation Enduring Freedom lasted just over 44 hours. Fatigue management of the two-person crew was a serious concern to the unit commanders for long duration sorties [20]. Operating UAS may not have crew fatigue problem as crews can be rotated during the

mission. For example, Predator missions (typically lasting 16 hours or more) require two sets of pilots and sensor operators who are rotated every four hours or less to reduce fatigue [21].

Dirty missions such as collecting radioactive samples are best performed by unmanned systems. In 1948, when the USAF decided that the risk associated with humans flying through nuclear clouds within minutes after bomb detonation to collect radioactive samples was “manageable,” pilots wearing 60-lb lead suits were sent to perform the missions. Some of these pilots subsequently died due to being trapped by their lead suits after crashing or due to long-term radiation effects. If UAs are sent to perform these missions instead, the probability of mission success may increase and human exposure will definitely decrease.

Reconnaissance missions have historically been dangerous. Twenty five percent of the 3<sup>rd</sup> Reconnaissance Group’s pilots were lost in North Africa during World War II, compared to five percent of bomber crews flying over Germany [7]. The risk associated with flying reconnaissance missions over the USSR became politically and militarily unacceptable when Francis Gary Powers was shot down in his U-2 and captured on May 1, 1960. Manned reconnaissance flights over the USSR stopped the next day [7]. On the other hand, when seven UAs (AQM-34 Firebees) were lost over China between 1965 and 1971, it was hardly noticed by the U.S. public [7]. The employment of UAs not only reduces the risk of human loss in high threat environments, it also reduces political impact.

## **1. Mission Priorities for UAS**

The Office of the Secretary of Defense (OSD), in 2006, requested input from combatant commanders (COCOM) and military departments to prioritize the DoD’s unmanned mission needs. Each COCOM and military department was asked to rank mission areas across various types and classes of UAS. The priority lists as shown in Table 3 represent a best fit of the data received.

The aircraft classes used in Table 3 are defined by OSD [20] as:

- **Small** - Gross takeoff weight (GTOW) less than 55 lbs.
- **Tactical** - GTOW between 55 and 1320 lbs.
- **Theater** - GTOW greater than 1320 lbs.
- **Combat** - An aircraft designed from inception as a strike platform with internal bomb bays or external weapons pylons, a high level of survivability, and a GTOW greater than 1320 lbs. An example is the Navy Unmanned Combat Air System.

Table 3. COCOM and Military Department UAS Needs Prioritized By Aircraft Class [After 20].

Mission Area	Small	Tactical	Theater	Combat
Reconnaissance	1	1	1	1
Precision Target Location and Designation	2	2	2	2
Signals Intelligence	7	3	3	4
Battle Management	3	4	5	6
Communications/Data Relay	8	6	4	7
CBRNE Reconnaissance	5	5	9	8
Combat Search and Rescue	4	7	8	9
Weaponization/Strike	16	8	7	3
Electronic Warfare	12	11	6	5
Mine Detection/Countermeasures	6	9	12	11

It can be seen in Table 3 that the top two missions across all aircraft types are reconnaissance and precision target location and designation. These missions require UAS to fly deep into the adversary's territory (in exceptional cases where the payload has excellent target detection probability and relative long range lasing, UAS need not fly into the adversary's territory). UAS is exposed to lots of danger and requires good combat survivability to ensure that it can perform the missions.

## **2. Intelligence, Surveillance and Reconnaissance**

Intelligence, Surveillance and Reconnaissance (ISR) is defined in Joint Publication 1-02 DoD Dictionary as:

An activity that synchronizes and integrates the planning and operation of sensors, assets, and processing, exploitation, and dissemination systems in direct support of current and future operations. This is an integrated intelligence and operations function.

When separated, each term is defined in the same publication as:

Intelligence – The product resulting from the collection, processing, integration, evaluation, analysis, and interpretation of available information concerning foreign nations, hostile or potentially hostile forces or elements, or areas of actual or potential operations. The term is also applied to the activity which results in the product and to the organizations engaged in such activity.

Surveillance – The systematic observation of aerospace, surface, or subsurface areas, places, persons, or things, by visual, aural, electronic, photographic, or other means.

Reconnaissance – A mission undertaken to obtain, by visual observation or other detection methods, information about the activities and resources of an enemy or adversary, or to secure data concerning the meteorological, hydrographic, or geographic characteristics of a particular area.

The terms “surveillance” and “reconnaissance” are also defined in the Canadian Military Journal, Vol 2, No. 4, Winter 2001-2002 [22] as

Surveillance – Systematic observation by technical sensors or human beings.

Reconnaissance – Directed mission(s) to obtain specific information.

As can be seen, reconnaissance is a subset of surveillance, which in turn is a subset of intelligence. As the equipment required for a UA to perform intelligence gathering, surveillance or reconnaissance is very similar, ISR missions are discussed together in this thesis.



ISR (especially reconnaissance) is probably the most common type of mission for a UAS. UAs have an established and growing record of supporting ISR missions. The importance of ISR was recognized when USAF Col. Eric Mathewson, director of the Air Force Unmanned Aircraft Systems Task Force, commented on October 17, 2008, that “ISR and intelligence missions are no longer support operations, they are the operations [23].” The endurance attribute makes UAs extremely suitable for ISR missions, especially if the mission requires persistent coverage. The “humanless” attribute of UAs also makes it an excellent candidate for reconnaissance missions deep inside the adversary’s territory as there is no danger of having a soldier captured while performing the mission. ISR missions typically imply detection, recognition, identification, and classification of targets (stationary and moving) during day and night.

*a. Payload*

Payloads for ISR are either passive or active sensors. Passive sensors do not intentionally or actively radiate any energy but rely on radiated energy from their targets. Passive sensors include TV cameras, infrared cameras (such as FLIR) for imagery intelligence (IMINT) missions, and radio receivers as well as radio direction-finding equipment for SIGINT missions.

Active sensors, on the other hand, transmit energy and detect energy reflected directly or indirectly from the targets. The transmitted energy must be sufficiently distinguishable so that there is ample energy reflected from the target and detected by the sensor. An example of an active sensor is radar (SAR for IMINT).

The sensor payloads play an important role in the combat survivability of the UA. Payload performance may determine the UA’s exposure to threat. A sensor with a long detection range may allow the UA to have a longer stand-off range to the threat. A sensor with better resolution may mean the probability of detecting the target is high, thus reducing the number of revisits required. Active sensors are also energy sources that can be exploited by the adversary to detect the UA. Changing the energy level may reduce the likelihood of the adversary detecting the energy signatures of the

UA, but may also affect the performance of the sensor. A balance between the survivability requirement and performance requirement needs to be achieved.

### **3. Precision Target Location and Designation**

Precision target location and designation is a two part function. The first part of the function, target location, derives target coordinates. This requires both precise measurement of the target position relative to the UA and accurate reading of the UA's position. Measurement of the target position relative to the UA can be achieved with laser measuring equipment, measurement of the angular position of the optic sensor, spectral interferometry or other geometric determining methods. Reading of the UA position, meanwhile, depends on the Global Positioning System (GPS), Inertia Navigation System (INS), or radio measurement using data link.

The second part of the function, target designation, is the indication of a target [20]. Precision target location and designation missions can be performed with the same payload used for IMINT except when precision-guided munitions (PGM) are to be used. To guide PGM, a laser designator feature needs to be added to the UA so as to illuminate the target for destruction either by the same platform or by another platform.

The act of lasing the target affects the combat survivability of the UA. When the UA lases the target, the adversary with the right equipment can detect and locate the UA, thereby increasing the probability of the adversary killing the UA. Proper tactics must be employed to ensure that the lasing period is shorter than the detection frequency (or its logical electronic processing equivalent) so as to minimize the UA exposure to threat.

### **C. FUNCTIONS REQUIRED TO PERFORM MISSION**

Performing a UAS mission is a complex operation involving at least nine major functions. The flight profile needs to be planned before the mission begins. The UA then needs to be launched and flown safely to the correct target area. When over the target area, the payload needs to be operational, and the communication between the GCS and UA needs to be maintained to ensure constant live feed of the target area. Upon completion of the mission, the UA needs to be recovered, and finally, turned around for

the next mission. Disruption to any of the functions may lead to degradation of the mission performance. For example, if the communication between the GCS and UA is disrupted, the UA will not be able to provide real-time video to its customers, thus failing its mission. In some cases, the entire UAS (or parts of it) may even be destroyed.

The quality of many of these functions also has an impact on the survivability of UAS. For example, if the flight profile is poorly planned and the UA is to fly over a heavily defended area, it is more likely that the UA will be shot down by air defense components.

The performance of some functions may even attract the attention of the adversary to UAS. For example, an adversary with radio direction-finding capability may be able to locate the positions of the GCS and/or UA by detecting and analyzing the data link between the two subsystems. UAS is especially susceptible to such detection if constant communication between the GCS and UA is to be maintained.

As an example to demonstrate the complexity of performing a UAS mission, a functional analysis of the functions required to perform a reconnaissance operation by UAS is performed (see Figure 17). Even though the functions identified are based on one UA performing the reconnaissance mission, many of the functions are also applicable when a UAS is performing other mission types. The figure illustrates the complexity of operating an UAS. Many of these functions need to be protected or performed well to ensure the survivability of UAS.

<b>To Perform Unmanned Aircraft System Reconnaissance Operations</b>	
1.0	Plan Flight Profile/Route
1.1.0	Understand mission
1.2.0	Identify locations of threats
1.3.0	Know about area of operations
1.3.1	Find out about terrain in area of operations
1.3.2	Find out about threat in area of operations
1.3.3	Find out about weather in area of operations
1.3.4	Find out about other friendly assets in area of operations
1.4.0	Identify target areas

1.5.0	De-conflict with other air assets
1.6.0	Decide on number of UAs required for mission
1.7.0	Decide on number of crew and rotation needed
2.0	Prepare the UA
2.1.0	Perform preflight tasks
2.1.1	Plan for mission
2.1.2	Pilot and sensor operator briefed on mission and plan
2.1.3	Perform preflight inspections/checks
2.1.4	Fuel UA for mission
2.1.5	Prepare payload for mission
2.2.0	Launch UA
2.2.1	Start engine
2.2.2	Position UA on launch point (start of runway or on catapult, etc.)
2.2.3	Accelerate to take off speed
2.2.4	External pilot hands UA control over to mission pilot (aka internal pilot)
3.0	Fly the UA
3.1.0	Fly
3.1.1	Generate thrust
3.1.2	Generate lift
3.1.3	Pitch, roll and yaw
3.2.0	Navigate
3.2.1	Measure current position of UA
3.2.1.1	Measure altitude
3.2.1.2	Measure coordinates
3.2.2	Know position of waypoints / targets (coordinates and altitudes)
3.3.0	Control flight (autonomously or manually)
3.3.1	Know current state of UA (altitude, angle of attack, roll angle, etc)
3.3.1.1	Measure angle of attack
3.3.1.2	Measure altitude
3.3.1.3	Measure roll angle
3.3.1.4	Measure pitch angle
3.3.1.5	Measure heading
3.3.2	Fly UA to desired altitude, speed, and direction
3.3.2.1	Adjust thrust and/or move elevator to change altitude
3.3.2.2	Adjust thrust and/or move ailerons and/or rudder to roll
3.3.2.3	Adjust thrust and/or move and/or rudder to yaw

3.4.0	Communicate between operator and UA
3.4.1	To encrypt uplink
3.4.2	To transmit messages / data
3.4.3	To point transmitting antenna towards receiving antenna and vice versa
3.5.0	To maintain situational awareness of operator
3.5.1	Interpret status of UA from various display
3.5.2	Interpret what UA sensor is picking up
3.5.3	Understand information (coming from other sources) on area of operations
3.5.4	Form cognitive picture of situation
4.0	UA Performs Mission
4.1.0	Operate payload
4.1.1	Know the environment (including weather) that UA is currently in
4.1.2	Understand characteristics of payload and how the current environment affects performance
4.1.3	Control payload remotely from GCS
4.2.0	Install the right payload on UA
4.2.1	Know the mission
4.2.1.1	Know target to look for so that UA can bring the right payload
4.2.2	Know weather condition of the target area so that UA can bring the right payload
4.3.0	To arrive at area of operations
4.3.1	Survive long enough in the hostile environment to arrive at area of operations and perform mission
4.4.0	Maintain coverage over target area for required time
4.5.0	Send images/videos to operator
4.5.1	Maintain down link between UA and GCS
4.6.0	To interpret image/video
4.6.1	Obtain images of sufficient quality for interpretation
4.7.0	Maintain UA in state that is optimal/necessary for payload operation
5.0	UAS to Survive Hostile Environment
5.1.0	Avoid being hit by damage mechanism from adversary
5.1.1	Avoid detection by adversary
5.1.2	Prevent adversary from obtaining a firing solution on UAS
5.1.3	Prevent the threat damage mechanism from hitting UAS
5.2.0	Avoid being killed by damage
5.2.1	Resist damage (especially to critical components)

5.2.2	Tolerate damage (especially to critical components)
6.0	Post-Mission
6.1.0	Recover UA
6.1.1	Launch pilot (aka external pilot) takes UA control over from mission pilot (aka internal pilot)
6.1.2	Prepare UA for landing
6.1.2.1	Decelerate UA
6.1.2.2	Position UA to landing point
6.1.3	Land UA or trap UA
6.1.4	Stop UA engine
6.1.5	Stop UA from moving
6.2.0	Perform post-flight tasks
6.2.1	Perform post-flight inspection / checks
6.2.2	Prepare UA for next mission
7.0	Maintain UAS
7.1.0	Perform preventive maintenance
7.2.0	Perform corrective maintenance
7.3.0	Perform inspections (pre-flight, post-flight, etc.)
8.0	Support UAS
8.1.0	Provide spares
8.2.0	Train operators, intelligence officers (to interpret what UA sees), and technicians
8.3.0	Provide integrated logistics support
8.4.0	Transport UA, GCS, and other support equipment to launch site or from recovery site
8.5.0	Store UA, GCS and other related equipment
9.0	Communicate to Supported Unit
9.1.0	Provide intelligence that the supported unit requires
9.2.0	Supported unit tells UA operator area of operations

Figure 17. Functions Required to Perform Unmanned Aircraft System Reconnaissance Operations.

#### **D. CHAPTER SUMMARY**

This chapter provided an introduction to UAS. As can be seen, UAS can be broken down into six major subsystems. Each of these subsystems is a candidate for survivability enhancement so as to achieve the overall survivability improvement.

A functional analysis of the steps involved in a reconnaissance mission illustrates the complexity of a UAS operation. Many of these functions can attract the adversary's attention to UAS while the disruption of other functions may lead to the destruction of UAS.

## **IV. THREAT TO UAS**

Threats to UAS have evolved since the 1960s. Fighter aircraft were the primary threat to American UAs during the Vietnam War. Surface-to-Air missiles (SAMs) then became the primary threats during conflicts in Syria and Angola in the 1980s [7]. Encounters in recent conflicts show that small arms and anti-aircraft artilleries have now become the new primary threats. Threats to UAS will continue to evolve due to tactical, strategic, technological, and political factors [7]. It is important to appreciate the dimensions and characteristics of the threat environment the system will likely encounter so as to better design for survivability of the system.

### **A. INTELLIGENCE**

Accurate intelligence information about UAS employment and operations will allow the adversary to narrow the spectrum of UAS characteristics to attack in a specific region or conflict. The adversary can tailor its anti-UAS defense to UAS to maximize its effectiveness. For example, if it is known that the UA communicates with the GCS within a fixed bandwidth, the adversary can rely solely on disruption or taking control of the communication link within that bandwidth. As the counteraction is more in focus, there is a higher chance for the adversary to succeed.

With observations and intelligence on UAS operations, the adversary may be able to recognize patterns or limitations of UAS. Such intelligence can be exploited to affect the mission effectiveness of UAS. During Operation Allied Forces, most NATO UAs were based in Macedonia and only launched from a handful of sites. The Serbs were able to gather such information on UAS deployment and positioned their air defense elements near likely UA flight paths. During the same war, German UAS units had operated in a very predictable pattern. They launched their UA at the same time everyday for several weeks. The Serbs recognized this pattern and had their air defense forces ready as targets appear at specific times [24].



An adversary may also target UA launch and support facilities before the UA can be used to perform its mission [25]. If these facilities are destroyed, the UA can not be launched or recovered, or turned around in time for the next mission. UA availability will be adversely reduced. It is therefore necessary to prevent the adversary from locating the ground elements. As with other military systems, it is important to prevent the adversary from gathering useful intelligence on operations, locations, and capabilities of UAS.

## **B. SEARCH AND SURVEILLANCE CAPABILITIES**

The adversary has various means (e.g., radar, electro-optical sensors, thermal imagers) that can be used to search for UAS. These means can be either active or passive.

### **1. Radar**

Radar can have relatively large search volumes and long ranges, making it desirable for the adversary to use for searching air space for the UA. Today, many types of radar can operate between 138 MHz and 36 GHz, though most of the radars against aircraft transmit between 2 and 18 GHz [26]. Most radars are capable of measuring range, radial velocity, and angular position (azimuth and elevation) of their targets. Low frequency radar may give effectively higher radar cross-section (RCS) so even smaller UAs with lower RCS can be detected. It is possible to detect UAs reliably with radar cross-sections as small as  $0.001 \text{ m}^2$  at ranges as far as 65 km [27].

Some radar is even capable of providing three-dimensional accuracy in severe clutter and electronic countermeasure (ECM) environments. These radars achieve high definition by minimizing clutter effects for low-level detection, hostile ECM effectiveness, and susceptibility to anti-radiation attack. Radar can be virtually “all-weather” (except in heavy rainfall or snow where RF signals are significantly attenuated) and have day/night capabilities, and thus can be used for surveillance of the sky 24 hours a day, 7 days a week.

## **2. Electro-Optical Sensors**

Electro-Optical (EO) sensors detect signatures in the visible electromagnetic radiation range (wavelengths between 400 nm and 700 nm). Detection of the UA using EO sensors is dependent on environmental factors and contrast between the UA and its local environment. Fogs, clouds, heavy haze, and heavy rain significantly degrade the performance of these EO sensors. It is possible to detect a UA at ranges up to 10 km using EO sensors [27]. Examples of EO sensors include TV cameras (for daytime) and image intensifiers (for night vision).

Most EO sensors are passive systems that emit no tell-tale sign of their usage in tracking the UA. The UA is therefore often caught by surprise when EO sensors are used in conjunction with lethal threats to the UA.

## **3. Thermal Imager**

Thermal imagers use thermal radiation emitted by the objects themselves to form images of the objects. Thermal imagers typically operate in two major atmospheric windows ( $3.0 - 5.5 \mu\text{m}$  and  $8.0 - 14.0 \mu\text{m}$ ). The imaging systems are capable of providing information on a target's angular positions (azimuth and elevation). Thermal detection of UAs is dependent on environmental factors as thermal imagers can have good performance in most weather (except in foggy, cloudy, or rainy environments). Hot targets that produce temperature differences of at least 10 K with respect to their environment can be detected at ranges of 10 – 20 km [26]. Thermal imagers can have excellent angular resolution, to as low as  $25 \mu\text{rad}$ .

As thermal imagers are passive systems, they can be used to track a UAS without the operator potentially knowing. The first sign of trouble for the target will be when a weapon is launched at it. Also, as target recognition is only possible at relatively short ranges, the standoff range between the UA and the threat is likely to be short.

## **4. Passive Radio Frequency Intercept**

The active emissions of a UA can be exploited by the adversary for detection. Adversary using direction-finding equipment can locate an UA within a resolution of less

than 15 degrees in one second and five degrees in 10-20 seconds. Some equipment is capable of detecting low band emitters, such as data links, from 14 kilometers or greater. It can be expected that active jammers and radars with stronger powers may be detectable at even greater ranges [28].

As can be seen, radio frequency intercept can detect an active UA at long ranges in a very short period. With persistent surveillance, radio frequency intercept can even detect short bursts of intermittent data link transmissions. Information gathered through radio frequency intercepts often allows the adversary to identify the emitter.

As radio frequency intercept is passive, the UA may not be aware that it has been detected by the adversary. The adversary can then cue other sensor systems to better identify the UA.

## **C. THREAT WITH HARD-KILL CAPABILITY**

Some threat elements have hard-kill capabilities that can damage or even kill UAS. In some cases, these elements can cause the death of personnel supporting UAS operations. These elements include anti-aircraft artilleries (AAA), SAMs, other aircraft (such as fighter aircraft or helicopters), and ground forces.

### **1. Anti-Aircraft Artillery**

AAA is the oldest form of an air defense system. The AAAs are guns that range from 23 mm to 130 mm caliber and have high rates of fire (e.g., a Russian ZU-23 can fire a maximum of 2000 rounds per minute). AAA may be mobile (limited to smaller caliber AAA) or fixed. They can have optical fire control or radar fire control. AAAs are typically effective up to 10,000 ft, with radar-guided AAA achieving higher effective altitudes than optic-guided ones.

### **2. Surface-Air Missile**

SAMs are designed to destroy aircraft. SAMs can be IR-guided, radar-guided, laser-guided, or optical-guided. SAMs are broadly classified into two categories, namely man portable (also known as MANPADS) and others. MANPADS are typically smaller

than other SAMs and are mostly IR-guided. Most MANPADS are effective up to 15,000 feet. As they are man portable, MANPADS are highly mobile, and therefore the threats can be scattered over a large area. As they are typically IR-guided, the detection of MANPADS before launch is almost impossible.

Larger SAMs typically have larger warheads and longer effective ranges. The optically-guided SA-6 has an effective altitude of 46,000 feet while the radar-guided MIM-104 Patriot can reach as high as 80,000 feet. Virtually all larger UAs are within reach of these larger SAMs. As most of the larger SAMs work with air-search radars, it is possible to avoid these SAMs before the missiles are launched.

### **3. Other Aircraft**

Other aircraft have been used to destroy UAs. Records include Soviet MIGs shooting down Ryan Firebee during the Vietnam War, an Iraqi MIG-25 destroying a MQ-1 Predator in 2002, and a presumably Russian MiG-29 shooting down a Georgian Hermes 450 in 2008. In 1999, there were even accounts of Serbs launching Mi-8 HIP helicopters to fly alongside UAs belonging to the Allied forces and helicopter door gunners blasting the UA with 7.62 mm machine guns [24]. Since most UAs are unable to defend themselves against their attackers, nor shoot at the attackers, the attacking aircraft almost certainly has a 100 percent kill rate.

Other than attacking UAs, adversaries may also use their aircraft against the ground elements of UAS. Airstrikes can be called onto GCS and GSE when their locations are determined.

### **4. Ground Forces**

Ground troops may make “lucky” shots that are capable of destroying a UA flying overhead. This threat is especially true for small, slow, and low-flying UAs. On September 23, 2008, Georgians claim that their police officers shot down a Russian UA that was flying at about 160 feet altitude. The police officers achieved this feat with only their automatic weapons [29].

Ground troops probably pose more of a threat against the ground elements such as GCS and GSE. Once the location of the ground elements (especially GCS) is determined, artillery can be called upon them or ground troops may even be sent to take control over the elements. Since there is typically more UAs than GCS in a UAS (some GCS may control up to four UAs), the loss of one GCS will have more impact on overall mission or campaign success than losing one UA.

#### **D. THREAT WITH SOFT-KILL CAPABILITY**

There exists some threats that have soft-kill capabilities instead of hard-kill capabilities. Damages caused by these threats can be temporary or permanent. At times, it may be sufficient for the threat to cause just temporary disruption to UAS performing its mission. For example, the adversary can temporarily blind the UA's SAR payload (by jamming) just when the adversary is moving its forces.

##### **1. Jamming**

An adversary can use jamming techniques to reduce the effectiveness of the UA's radar payload or the communication data link of UAS. Noise jammers transmit strong noise signals to "drown" out the echoes returning to the radars or the communication signals of the data links. Under such conditions, Synthetic Aperture Radar (SAR) may not be able to provide a usable image of the target. The GCS may not be able to receive real-time video feeds from the UA. The UA may not receive critical commands from the GCS, thus missing a turn or not being able to execute a change in the mission.

##### **2. Software Virus**

Many of the functions of a UAS, such as mission planning, controlling of the UA and payload, and receiving information from sensors, are software driven. An attack by malicious software such as a virus or Trojan horse may severely affect mission success. The malicious software can be introduced into the system through an unprotected data link or during software upgrades, modifications, or initial coding by rouge contractors.

### **3. Electromagnetic Pulse (EMP)**

EMPs can be produced using either nuclear weapons or non-nuclear weapons such as a large low-inductance capacitor with a single-loop antenna and a microwave generator. The resultant electromagnetic energy may induce currents or voltage surges in the electrical circuits. Depending on the amount of the radiation and coupling effectiveness, damages may be temporary or permanent (such as circuit burn). As most of the functions of UAS depend heavily on electronic components, UAS is therefore susceptible to an EMP attack.

### **E. CHAPTER SUMMARY**

Potential threats to a UAS are wide-ranging. The adversary can collect intelligence about UAS, detect UAS using a wide range of active and passive sensors, and select either hard-kill or soft-kill options to destroy UAS (entire UAS or parts of it) or disrupt its operations.

Sensors exploit the weaknesses of a UAS to detect UAS while the kill options attack the weaknesses to destroy or disrupt UAS. More of these weaknesses will be discussed in the next chapter. Survivability enhancement options that either ameliorate or eliminate the weaknesses have to be identified and implemented.

THIS PAGE INTENTIONALLY LEFT BLANK

## V. UAS WEAKNESSES

The adversary can exploit UAS weaknesses to detect, identify, and track UAS or attack the weaknesses to destroy it. Therefore, it is important that these weaknesses are identified and either reduced or eliminated to enhance the combat survivability of UAS. This chapter combines the results from the physical decomposition and functional analysis performed in Chapter III to identify UAS weaknesses.

### A. WEAKNESSES DUE TO PHYSICAL COMPONENTS

Signatures emitted by physical components can be exploited by an adversary to detect UAS. For example, the heat signature can be exploited by the adversary's thermal imager to detect, identify, and classify. The airframe reflects radar energy directed at it, so if it is not designed to minimize radar cross-section, the UA may be detected by the adversary's air defense radars.

Degradation of many of these physical components may also result in the destruction of UAS subsystem. A direct hit from the adversary's artillery on the GCS may mean the destruction of the GCS and possibly death to the operators inside it. A hit (direct or indirect) to the UA's fuel system may result in the rupture of the fuel lines, and cause the UA to crash as it runs out of fuel (unless it lands before this happens).

### B. WEAKNESSES DUE TO PERFORMING FUNCTIONS

UAS, while performing some functions, may emit signatures that can be detected by the adversary. For example, the communication between the GCS and UA allows an adversary with radio direction-finding equipment to locate the positions of the GCS and/or UA. UAS is especially susceptible to such detection if constant communication between the GCS and UA is maintained.

The adversary can also cause the degradation of some UAS functions so as to affect the effectiveness of UAS or even its destruction. For example, the data link between the GCS and UA can be jammed by the adversary such that the operator cannot



send commands to the UA to change altitude, speed, and direction to avoid a mountain. This will lead to the UA eventually crashing.

**C. IDENTIFY UAS WEAKNESSES**

Each component identified in the physical decomposition performed earlier (see Figure 16 and each function identified in the functional decomposition performed (see Figure 17) is examined to see whether it emits signature that can be detected by potential threats (see Chapter IV), and whether the loss or degradation of the component or function will lead to the destruction of UAS subsystem. The physical results are presented in Table 4 and the functional results are indicated in Table 5.

Table 4. Physical Components That Either Emit Signal Or If Degraded, Will Lead To Destruction of UAS

Physical Components	Radar	Thermal Imager	RF Intercept	AAA	SAM	Aircraft	Ground Forces	Jamming	Software Virus	EMP
<b>Unmanned Aircraft</b>										
Airframe	x	x		x	x	x	x			
Propulsion	x	x		x	x	x	x			x
Communications/Identification System										
Navigation System								x	x	x
Fuel System				x	x	x	x			
Electrical System				x	x	x	x			x
Central Computer				x	x	x	x		x	x
Automatic Flight Control System				x	x	x	x		x	x
Auxiliary Equipment										
Built-in Test System										

<b>Physical Components</b>	<b>Radar</b>	<b>Thermal Imager</b>	<b>RF Intercept</b>	<b>AAA</b>	<b>SAM</b>	<b>Aircraft</b>	<b>Ground Forces</b>	<b>Jamming</b>	<b>Software Virus</b>	<b>EMP</b>
<b>Ground Control Station</b>										
UA Data Display and Controls						X	X		X	X
Mission Planning Equipment						X	X		X	X
Communications System			X			X	X	X	X	X
Shelter						X	X			
Auxiliary Equipment						X	X			
<b>Others</b>										
Payload	X	X	X	X	X	X	X	X	X	X
Launch & Recovery System	X	X				X	X		X	X
Ground Support Equipment	X	X				X	X		X	X

Table 5. Functions That Either Emit a Signal Or If Degraded, Will Lead To Destruction of UAS.

<b>Functions</b>	<b>Function Emits Signature</b>	<b>Degradation Function Will Lead To UAS Destruction</b>
Understand Mission		X
Identify Threats Locations		
Know about Area of Operations		X
Identify Target Areas		X
Deconflict with Other Air Assets		X

Functions	Function Emits Signature	Degradation Function Will Lead To UAS Destruction
Decide on Number of UA Required for Mission		
Decide on Number of Crew and Rotation Needed		x
Perform Pre-flight Tasks		x
Launch UA		x
Fly	x	x
Navigate		x
Control Flight (Autonomously or Manually)		x
Communicate between Operator and UA	x	x
Maintain Situational Awareness of Operator		x
Operate Payload	x	x
Install the Right Payload on UA		
Arrive at Area of Operations	x	
Maintain Coverage Over Target Area for Required Time	x	
Send Images/Videos to Operator	x	
Interpret Images/Videos		x
Maintain UA in State that is Optimal/Necessary for Payload Operation	x	
Avoid Being Hit by Damage Mechanism from Adversary		
Avoid Being Killed by Damage		
Recover UA		x
Perform Post-flight Tasks		
Perform Preventive Maintenance		x
Perform Corrective Maintenance		x
Perform Inspections (Pre-flight, Post-flight, etc.)		x

<b>Functions</b>	<b>Function Emits Signature</b>	<b>Degradation Function Will Lead To UAS Destruction</b>
Provide Spares	x	x
Train Operators, Intelligence Officers (to Interpret what the UA sees), and Technicians		x
Provide Integrated Logistic Support	x	x
Transport UA, GCS, and Other Support Equipment to Launch Site or From Recovery Site	x	
Store UA, GCS, and Other Related Equipment		
Provide Intelligence that the Supported Unit Requires	x	
Supported Unit Tells UA Operator Area of Operations	x	

Results in Table 4 and Table 5 are then translated into UAS weaknesses. Combat survivability enhancement concepts identified in Chapter II can be used to improve or eliminate these weaknesses. These weaknesses and their corresponding survivability enhancement concepts are identified and summarized in Table 6. These concepts will be used to identify combat survivability enhancement options in the next chapter.

Table 6. UAS Weaknesses And Corresponding Survivability Enhancement Concepts To Improve Or Eliminate Weaknesses

<b>Weaknesses</b>	<b>Survivability Enhancement Concepts</b>
Some components such as airframe and propulsion system have large RCS	<ul style="list-style-type: none"> <li>• Reduce signature of UAS</li> <li>• Jam/deceive sensor</li> <li>• Using expendables to distract threat propagator</li> </ul>
Some components such as airframe and propulsion system have high IR signature	<ul style="list-style-type: none"> <li>• Reduce signature of UAS</li> <li>• Jam/deceive sensor</li> <li>• Using expendables to distract threat propagator</li> </ul>
Damages to various components such as fuel system, electrical system, central computers, etc. can lead to the destruction of UAS	<ul style="list-style-type: none"> <li>• Suppress damage</li> <li>• Install redundant components (with separation)</li> <li>• Locate critical components in a way that reduce probability of the damage from killing UAS</li> <li>• Shield critical components</li> <li>• Eliminate components</li> </ul>
The communication system and payload are susceptible to jamming	<ul style="list-style-type: none"> <li>• Improve performance (of these components)</li> <li>• Suppress threat</li> <li>• Increase stand-off range</li> <li>• Suppress damage</li> </ul>
Some components that are software-driven are susceptible to software virus attack	<ul style="list-style-type: none"> <li>• Gather intelligence about threat</li> <li>• Warn about presence of threat</li> <li>• Suppress threat</li> <li>• Suppress damage</li> </ul>
Various components are susceptible to EMP attack	<ul style="list-style-type: none"> <li>• Shield critical components</li> <li>• Eliminate components</li> </ul>
Degradation of some functions related to mission planning (i.e., understand the mission, know about area of operations, identify threat	<ul style="list-style-type: none"> <li>• Gather intelligence about threat</li> <li>• Warn about presence of threat</li> </ul>

Weaknesses	Survivability Enhancement Concepts
area) will lead to UAS destruction	
The performance of some functions emits signature that can be detected by the adversary (i.e., communicate between operator and UA, operating payload)	<ul style="list-style-type: none"> <li>• Warn about presence of threat</li> <li>• Improve system performance</li> <li>• Reduce signature of UAS</li> <li>• Tactics and training</li> </ul>
The performance of some support functions not only emit a signature that can be detected by the adversary, the degradation of these functions may lead to the destruction of UAS (i.e., provide integrated logistic support, supported unit tells UA operator area of operations)	<ul style="list-style-type: none"> <li>• Gather intelligence about threat</li> <li>• Warn about presence of threat</li> <li>• Jam/deceive sensor</li> <li>• Reduce signature of UAS</li> <li>• Tactics and training</li> </ul>

#### D. CHAPTER SUMMARY

The adversary can exploit UAS weaknesses to detect, identify, and track UAS or attack the weaknesses to destroy it. This chapter identified the weaknesses. Combat survivability enhancement options will be identified in the next chapter to ameliorate or eliminate these weaknesses.

THIS PAGE INTENTIONALLY LEFT BLANK

## **VI. COMBAT SURVIVABILITY ENHANCEMENT OPTIONS**

### **A. UNMANNED AIRCRAFT**

A standard “one size fits all” solution to unmanned aircraft combat survivability is not available due to the wide range of sizes and performances of the UA. Smaller UA limited by size, weight carrying capability, and power is unlikely to be able to support survivability enhancements that will add (much) more weight and/or require (much) more power from the UA. Combat survivability enhancement options are thus very limited for smaller UAs. The larger UA, on the other hand, may have more options. There is a higher possibility that larger UAs can support active susceptibility reduction features such as electronic warfare (EW) countermeasures, threat-warning equipment, and/or vulnerability reduction features such as fire suppression equipment, self-sealing fuel tanks. However, as many UAs are not initially designed with much combat survivability in mind, there may be limited ability to enhance survivability before UAS reach their engineering limits. For example, designers usually leave little power margin for payloads and other equipment; therefore, considerations need to be made for power requirements of the enhancement options or the implementation of innovative power management techniques. That being said, some combat survivability enhancement options are worth considering.

#### **1. Increase Operating Altitude**

One combat survivability enhancement option is to increase the operating altitude. It can be expected that when one flies higher, there will likely be less threats that can reach it. During Desert Storm, Allied aircraft changed their tactics from low-altitude flights and strikes to medium-altitude (10,000 to 20,000 ft) so as to avoid enemy AAA [30,31]. Most AAA and SAMs have engagement altitudes that are up to 15,000 ft; therefore if the operating altitude of the UA can be increased to 15,000 ft or more, the threats faced by the UA can be reduced to only long range radar-guided SAMs and fighter aircraft.



Unless it is already designed with a flight ceiling higher than 15,000 ft, an existing UA will need to make physical changes in order to reach this altitude. To reach this altitude, modifications to the UA need to be made. To gain altitude, the lift must be greater than the total weight of the UA. As can be seen in Equation 1, lift force produced by a wing is related to the wing profile, density of the air ( $d$ ) and velocity of the airflow over it ( $v$ ).

$$L = Bdv^2 \quad (1)$$

where  $L$  is the lift in Newtons,  $d$  is the air density, and  $v$  is the velocity. The factor  $B$  depends on the profile of the wing (length and width).

Modifications to make a UA fly higher therefore must at least change the wing profile, increase velocity, or decrease weight. They may include replacing existing wings with ones that can generate more lift, replacing the propulsion system with one that can produce more thrust, lightening the UA by replacing current payloads with lighter payloads, or removing non-critical components, etc.

The altitude that the UA may go to is also limited by its sensor. If the sensor has poor resolution performance, the UA will need to fly lower to obtain a usable image with an acceptable clarity. Also, if the payload is an optic sensor, the UA will need fly below cloud cover to obtain the image.

## **2. Change Operating Speed**

The analysis by a Naval Postgraduate School (NPS) Master's student, Kevin McMIndes, suggested that a speed of at least 135 kts is required to ensure robust survivability regardless of threat, and survivability will increase appreciably up to about 225 kts [32]. McMIndes simulated an UA performing a reconnaissance mission over a target area defended by air defense units and infantry. The UA was modeled with various stealth levels, sensor detection ranges, operating altitude, and speed. Although the quoted figures may only be applicable to scenarios studied in McMIndes' analysis, his results show that fast speeds for a UA has a positive effect on survivability.

Unless the existing UA already has the capability for high speed dashes, increasing operating speed will require modifications to it. Modifications can be as “simple” as replacing the propulsion system with one that produces more thrust; or as complex as changing the aerodynamics of the UA so as to reduce drag.

Depending on the mission, a high operating speed may not always be desirable. For example, a high speed may not allow the sensor operator enough time to differentiate a target of interest from the background before the UA flies out of the area, and thus the target is missed.

Other than increasing the operating speed, it may also be reduced to enhance combat survivability. If the UA is flying slowly enough such that it is outside the velocity gate of the adversary’s radars, the radars will filter away the UA’s radar returns. The adversary therefore is unable to detect the UA with his radars.

Intelligence on the limits of the adversary’s radar velocity gate needs to be gathered before this option can become effective. The lower limit must also be higher than the UA’s stall speed before the option can be implemented. To achieve a low flying speed, modifications to the existing UA may be needed to change its aerodynamic characteristics.

### **3. Improve Situational Awareness**

The situational awareness of an operator sitting in the GCS is limited by the sensor’s field of view. Only what is detected in the sensor field is seen by the operator. The operator may not know that the UA is being tracked by the adversary’s radar and guns or missiles have been fired at it. The operator’s first sign of trouble will likely be when contact is lost with the UA. He or she may not know what hit the aircraft, much less is he or she able to perform maneuvers or employ countermeasures. The operator may not even realize that the UA was shot down by hostile fire. The commander may send another asset into the area to investigate the crash, thus exposing the asset to danger, or another asset may be sent to perform the same mission along the same route, thus exposing the asset to the same threat. Improving the operator’s situational awareness thus is another way to enhance combat survivability.

Situational awareness can be improved by installing warning systems. The warning system may provide sufficient, timely, accurate and prioritized information on relevant threats to support decisions on further actions [33]. Warning systems include Radar Warning Receiver (RWR) system, Missile Warning Systems (MWS), and Laser Warning Systems (LWS).

*a. Radar Warning Receiver System*

The RWR system is a passive warning system that is effective against radio frequency (RF) threats such as radars. The RWR system measures the frequency, pulse width, amplitude, angle of arrival, and time of arrival of all RF signals it detects. As the majority of RF threats against the aircraft transmit at between 2 and 18 GHz, RWR systems are typically designed to cover this region [26]. The measured parameters are then compared by the system against a library of known emitters to distinguish whether the RF signal is from a friend or foe, the type of radar that is emitting the signal, and the modes of operation of the radar. The amplitude and time/angle of arrival are also used to determine the direction and approximate distance to the emitter [34]. To be able to perform all the above and yet provide sufficient and timely warning too, the RWR system requires (and should possess) real-time signal processing capabilities.

For platforms operating at high altitude a RWR system that can handle a high pulse densities is favorable, while a platform operating at low altitude can use a less complex and cheaper RWR system with less capability to handle high pulse densities.

RWR systems, with better capabilities, have the option of carrying out secondary missions of ELINT – to gather the electronic order of battle of the adversary.

A typical RWR system consists of the following physical components:

- Antennas (usually four)
- Receivers
- Signal processor
- Control unit
- Display unit (for a UAS, this will be located in the GCS)

Figure 18 shows an example of a RWR system. The LR-100 is a RWR/electronic support measures (ESM)/electronic intelligence (ELINT) receiver system. Weighing 73 lbs, the LR-100 has been marketed by Northrop Grumman Corporation as combat-proven and is well suited for installation on virtually any air, sea, or land-based platform, including lightweight UAs [35].



Figure 18. The LR-100 RWR System Shown with Azimuth Antenna Interferometer Unit (Four Each), Antenna Interface Unit, and Receiver Processor Unit [From 35].

RWR has the advantage of detecting radar signatures at long ranges. This allows the operator to maneuver the UA away from the threat sphere before any weapon is used against it.

#### ***b. Missile Warning System***

A MWS is effective in detecting all incoming missiles (regardless of whether RF-, IR-, Laser- or TV-guided), and it warns the operator when the UA is being shot at. This, incidentally, is also one of the leading requirements that come out from recent conflicts (in Iraq and Afghanistan) [36]. Other than being able to warn about incoming missiles, the MWS can also provide information about the time to intercept as well as the direction of the approaching missile and trigger launch of countermeasures [37].

There are three types of MWS, each using a different type of detector: 1) radar detector (using either continuous wave or pulse Doppler), 2) IR detector, and 3) UV detector. Most MWS use UV detectors. These detectors are effective in detecting missiles of older generations, but many modern missiles are now able to defeat them. UV detectors are also unable to detect post-burnout of missiles, thus restricting the detection range. MWS using IR detectors may be a better choice as they, being able to continue detecting missiles in post-burnout phases, can track the missiles for a longer period. Also, being passive detectors, MWS using IR detectors require less power than MWS that use radar detectors. As a testimony to MWS with IR detectors, the USAF, U.S. Navy, and U.S. Marine Corps are in the progress of replacing their UV detector-based MWS with a third generation MWS that uses infrared detectors [36]. The strengths and weakness of each type of MWS is summarized in Table 7.

Table 7. Strengths and Weaknesses Of Various MWS Technologies [After 33].

Type	Properties	
Radar - Pulse Doppler (PD)	PD operates in a different band (e.g. L) to avoid ESM/RWR systems operating above 2 GHz.	
	Strengths	Long range, all-weather, controllable false alarm rate, and independent of missile emissions
	Weaknesses	Active transmitter, strong ground clutter at low altitudes, the RCS of new missiles are decreasing so more difficult to detect.
Infrared (IR) (only monochromatic IR considered)	IR detection typically in 3-5 $\mu$ m band	
	Strengths	Detects both plume emission and hot engine parts, including post-burnout; lower atmospheric attenuation
	Weaknesses	Performance strongly limited by clutter, risk for saturation at short ranges due to the need for high sensitivity to provide long range detection, complex system due to need for cooling

Type	Properties	
Ultraviolet (UV)	UV detection of missile plume in the solar-blind region at 0.2-0.3 $\mu$ m band; built around an image-intensifier	
	Strengths	Minimal background clutter, hence lower demand on signal processing and reduced complexity; no cooling required; matured technology; lower cost
	Weaknesses	No post-burnout detection, restricted detection range due to ozone attenuation, UV clutter from man-made sources

A typical passive MWS consists of the following:

- One (revolving) to four (fixed) sensors
- Processor or electronic control unit

An Active MWS consists of the following:

- Antennas
- Receiver/transmitter unit
- Buffer storage unit

A MWS has the advantage of detecting all types of missiles or even aircraft that is being launched at the UA. However, the MWS only works after a weapon is launched at the UA, and therefore a quick reacting countermeasure is required to defeat the incoming threat.

*c. Laser Warning System*

A LWS is effective in detecting laser designation, laser beam riding missiles, etc. It is capable of determining the type of laser received and the direction of arrival. A LWS is also able to provide information on pulse repetition intervals so that it can be compared to a library of known threats to identify the threat.

A typical LWS consists of the following:

- Sensors (usually six for an aircraft, each covering 90° from bore sight and about ±45° in elevation)
- Processor

A LWS offers little time between the realizations of the UA being lased and a weapon being launched at it; therefore, a countermeasure is required to defeat the incoming threat (weapon).

*d. Considerations for Choosing Warning System*

It is unlikely that the UA, with its power and space constraints, will be able to install all three types of warning systems; therefore, careful considerations are needed in choosing the right warning system. Factors to consider include the type of threat the UA is likely to encounter, the size and power requirements of the warning system, and integration with other systems already existing on the UA.

Information about the three warning systems is summarized in Figure 19.

Figure 19. Summary of Threat Warning Systems.

<b>RWR</b>	<b>MWS</b>	<b>LWS</b>
<ul style="list-style-type: none"> <li>• Passive</li> </ul>	<ul style="list-style-type: none"> <li>• Passive or active</li> </ul>	<ul style="list-style-type: none"> <li>• Passive</li> </ul>
<ul style="list-style-type: none"> <li>• Detects RF threats only.</li> </ul>	<ul style="list-style-type: none"> <li>• Detects both RF and IR-guided missiles or any incoming threat that emits exhaust plume (other aircraft, etc.), but not able to detect AAA.</li> </ul>	<ul style="list-style-type: none"> <li>• Detects only threats that use laser as guidance.</li> </ul>

<b>RWR</b>	<b>MWS</b>	<b>LWS</b>
<ul style="list-style-type: none"> <li>• Medium to long lead-time between detecting RF threat and threat firing at UA.</li> </ul>	<ul style="list-style-type: none"> <li>• Short to medium lead-time between detecting threat and threat reaching UA.</li> </ul>	<ul style="list-style-type: none"> <li>• Short to medium lead-time between detecting laser guided threat and threat firing at UA.</li> </ul>
<ul style="list-style-type: none"> <li>• Combat survivability can be enhanced without installing countermeasures.</li> </ul>	<ul style="list-style-type: none"> <li>• Combat survivability can only be enhanced if countermeasure is installed.</li> </ul>	<ul style="list-style-type: none"> <li>• Combat survivability can only be enhanced if countermeasure is installed.</li> </ul>

#### **4. Countering Incoming Threats**

In some instances it may sufficient to install only the warning system to enhance combat survivability. For example, if RWR is installed, it may be able to detect that the UA is being tracked by the adversary’s radar. The operator can then decide to take evasive maneuvers like exiting the threat sphere before any anti-aircraft weapon can be used on the UA. However, in many other instances, it may be too late for the UA to exit the threat volume or the mission requires it to stay on course. The adversary may then launch a missile or send its fighters out to intercept the UA. Countering the incoming threat may be necessary.

##### ***a. Install Electronic Countermeasures***

One way of countering incoming threats is to install electronic countermeasures (CM). Electronic CMs can be broadly classified into four categories: 1) RFCM, 2) Laser CM, 3) IRCM and 4) communication CM. Only the first three types of CM will be discussed here, as the fourth CM will be discussed later under data link. The type of countermeasures to be installed is dependent on the type of threat the UA is likely to encounter.



## (1) RFCM – Chaff

The simplest countermeasure against radar is chaff. First used in WWII, chaffs are small strips of conducting materials (normally dipoles made of aluminum or thin glass fibers coated with aluminum or zinc) whose length is selected to make them good reflectors of radar energy. This length is half the radar wavelength that it is trying to counter [38]. Strands of chaffs are bundled together in cartridges or cassettes to be dispensed when needed. In order to be able to counter radars of different frequencies, strands of chaff in a cartridge are cut to different lengths to respond to different frequencies. When the radar wavelength is matched with the physical length of chaff strong returns are achieved, and the radar sees a larger target than the chaff physically is.

When dispensed, the chaff will form a cloud. The cloud will grow due to turbulence caused by the dispensing aircraft, natural air turbulence, differences in fall rates among the chaff, and prevailing wind. The chaff cloud needs to bloom rapidly so that the radar sees both the aircraft and the chaff in the same range bin. An air-launched chaff typically takes about 50 milliseconds to bloom [38]. Since high turbulent flow makes the chaff cloud grow rapidly, forward of, but not in line with, wing roots and the engine exhaust are good locations for the chaff dispenser. Some radars are able to reject second echoes that suddenly appear near the rear of their targets. To confuse these radars, some dispensers eject the chaff forward of the aircraft [13].

The effectiveness of chaff is not guaranteed. As chaff is light, it has insignificant momentum and loses speed rapidly after deployment. If the threat radar has sophisticated pulse-Doppler or moving target indicator signal processing capability, it will be able to distinguish the echoes of the near stationary chaff clouds from the echoes of the moving aircraft. Skilled radar operators can also track the UA through the chaff even though the tracking accuracy will likely be degraded.

The effectiveness of chaff is influenced by the UA's flight path after the chaff are ejected, the ability of the chaff cloud to provide the necessary radar

cross-section (RCS), the ability to remain aloft, and whether or not there is sufficient movement in the chaff cloud to provide a Doppler frequency shift.

The location of the dispenser is also important. The dispenser needs to be located such that chaff can bloom rapidly, yet the dispenser does not affect the aerodynamics of the UA drastically.

## (2) RFCM - RF Jammer

The objective of an RF jammer is to introduce a noise-like signal into the radar system to mask or obscure the target echo [37] so as to impair the ability of the adversary's radar to detect and track. The jammer generates the noise (at a level above the adversary's radar threshold) either continuously or intermittently and directs it into the radar. Noise is seen on the radar screen as a relative large area of clutter.

Three general techniques are used by the jammers. The first is broadband or barrage jamming. This is used when the radar frequency is either unknown or changing, or when there are multiple radars (operating at different frequencies) to be jammed. Jammers using barrage jamming transmit a noise signal in a frequency range that is much wider than the operating bandwidth of the radar. The second technique is spot jamming and is used when the radar frequency is known. The jammer transmits in a relatively narrow frequency band that is centered at the radar frequency and usually somewhat larger than the radar bandwidth. The third technique is swept jamming. The jammer transmits a noise signal of a narrow bandwidth in a rapid and repetitive sweeping manner across the range of frequencies to be jammed. Spot jamming is more efficient and requires less power as the noise signal bandwidth can be limited and directed. A RWR system is therefore valuable in this case as it can provide frequency and direction information that enables spot jamming.

As long as information about an adversary's radar (direction, frequency, angle, etc.) is known, noise jammers with adequate noise powers can degrade the radar's performance. One great limitation of noise jammers is that they require relatively high power as they may operate at 100% duty cycle. Low-power jammers may also not be sufficient in denying the adversary's radars from gathering directional

information about the UA. Since UAs are weight- and power-constrained platforms, it is unlikely that the high-powered noise jammers will find their way into many UAs.

### (3) RFCM – RF Deceivers

The objective of RF deceivers is to fool, confuse, or mislead the adversary's radar. Also known as deception jammers, repeaters or spoofers, RF deceivers fool radar systems by presenting false target information. Radar deception follows one of the following two general approaches: 1) generates large numbers of indistinguishable false targets to overload the radar, or 2) provides incorrect target bearing, range, or velocity information to the radar.

Many deception techniques are available today. The more common techniques include range gate pull-off, inverse con-scan, and angle deception [13, 37]. Radar deceivers typically require less power than noise jammers. This is especially true for deceivers countering pulse radars, as their duty cycles are comparable to the radar duty cycles (which are not 100% duty cycles). Disregarding size, the radar deceiver may thus be more suitable for UAs with power constraints. Some systems have both jamming and deceiving capabilities.

### (4) RFCM - RF Decoy

The objective of decoys is to draw an attacking missile away from the targets the decoys are protecting. Decoys achieve their objectives by making themselves more attractive to the attacker. Decoys can be classified into the following two categories: flying decoys and towed decoys.

Flying decoys are able to navigate on their own and can be self-powered or unpowered. They can be passive by only simulating the characteristics of the aircraft they are protecting (flight path, speed, RCS, etc.) or they can be active by carrying a radar jammer/deceiver. The McDonnell ADM-20 Quail is an example of a passive self-powered flying decoy. It presents radar images very similar to that of the B-52 and has similar flying characteristics of the B-52.

Towed decoys protect their host aircraft by emitting deceiving signals to seduce an attacking missile to themselves and away from their host. Computer simulations have shown that towed decoys can effectively reduce the probability of kill of UAs. This includes even UAs with limited maneuverability [39]. Towed decoys can generate both the signals by themselves (repeater decoys) or by a countermeasure system onboard the host aircraft and linked to the decoy by a fiber-optic cable. The second option of placing the countermeasures system onboard ensures that the more expensive countermeasure system can be used several times, and thus the cost of the decoy can be kept low. However, as most UAs have power and space constraints, it is unlikely that the second option can be used. Figure 20 shows the different configurations of airborne towed decoys. The configuration at the top shows the decoy having all components needed to generate a signal. This is the most expensive configuration but is suitable for more UAs. The configuration at the bottom shows a configuration where all components needed to generate the signal reside onboard the host aircraft. The decoy works as an antenna in this case. It is the least expensive configuration but is unsuitable for most UAs.

The towed decoy may or may not be recoverable. The RQ-4 Global Hawk is to be equipped with the AN/ALE-50 Towed Decoy System. These decoys are not recoverable. At an estimated cost of \$22,000 each [40], these decoys can be considered inexpensive when used to protect a RQ-4A that costs \$37.6 million each [41]. Trades between combat survivability and cost have to be made as well.

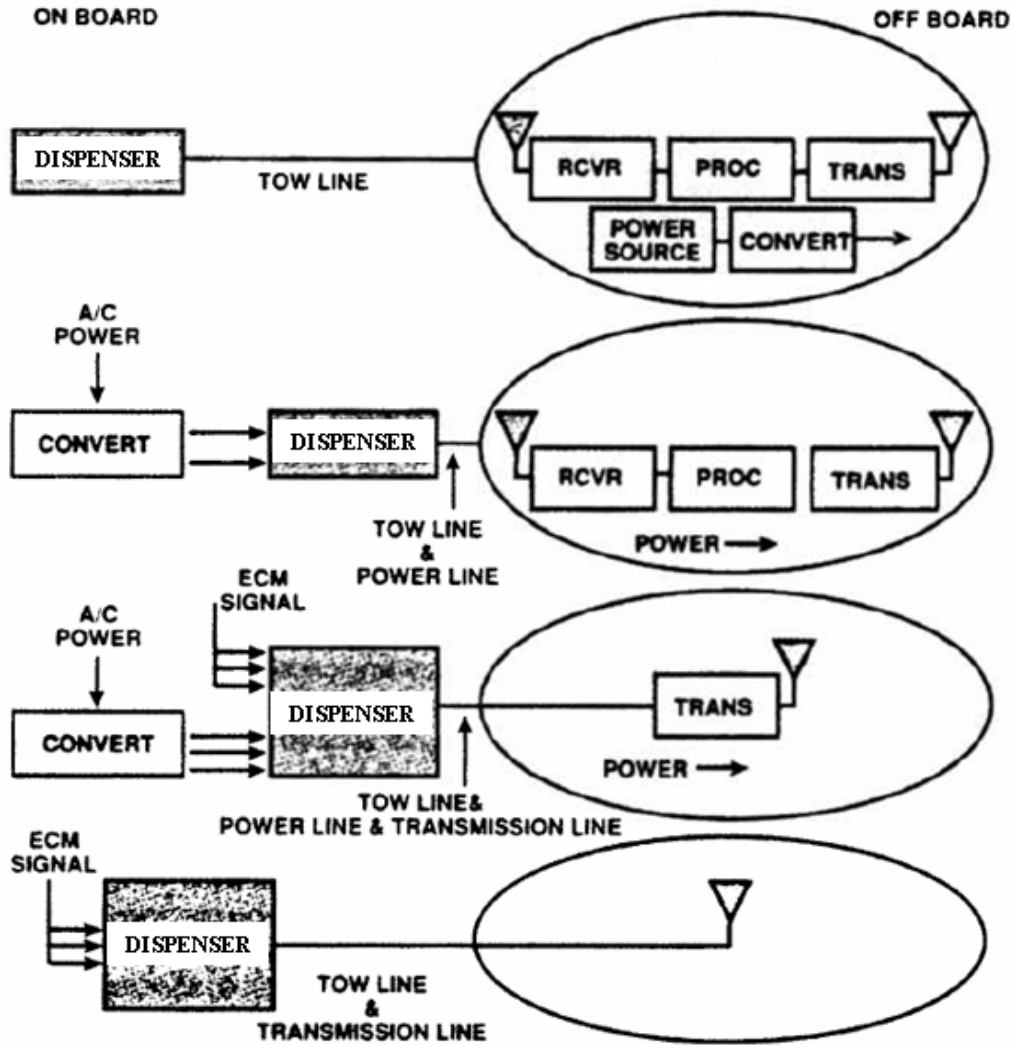

Figure 20. Different Configuration of Airborne Towed Decoy [From 37].

Due to power and physical constraints of existing UAs, it can be expected that there will be many difficulties in equipping them with towed decoys. If the benefit of using flying decoys (i.e., costs avoided when the UA that the decoys are protecting are not shot down) outweighs the cost of operating and supporting the decoys, using flying decoys becomes an attractive solution.

(5) IRCM – Flare

Flares are pyrotechnics designed to emit large amounts of radiation in the sensor bandwidth of an IR-guided missile to draw attacking IR-guided missiles away from the aircraft they are protecting. An IR-guided missile tracks the centroid of all the IR energy within its field of view. As a flare radiates significantly more IR energy than the aircraft it is protecting, the energy centroid is closer to the flare. This centroid starts to move away from the protected aircraft as the flare separates from the aircraft. Once the aircraft leaves the tracking field of view of the missile, the missile hones in on just the flare [43].

Modern IR-guided missiles, unfortunately, have features to reject flares. One such feature is the “two-color” IR detector. The energy level at each wavelength is unique for different temperatures. As shown in Figure 21, the spectral radiance versus wavelength curves are significantly different shapes for different temperatures. The detector measures the spectral radiant intensity in two wavelengths and compares the relative intensity in each wavelength to distinguish between the cooler aircraft (at 700 K) and the hotter flare (at 2,000 K).

Advanced flares consisting of an ensemble (cocktail) of flares can counter this two-color tracking. Each flare peaks in a different waveband, such that the combined signature matches that of the aircraft. Research is underway to replace the cocktails with new single materials that can match target spectral signatures [42]. The effectiveness of the flares will be influenced by the UA’s flight path after the flares were ejected, flare burn time, power output and spectral distribution, distribution of flares around the aircraft, and flare trajectories.

The systems safety aspect of using flares also has to be considered. When released below 1,000 ft, some conventional flares can cause ground fires [42]. Regardless of whether it will be released automatically or on command by operators in the GCS miles away, special attention must be made to ensure that there will not be

accidental release of flares over civilian areas (especially during peacetime). The risk of the inadvertent release of flares needs to be kept to a minimum before flares can be installed on UAs.

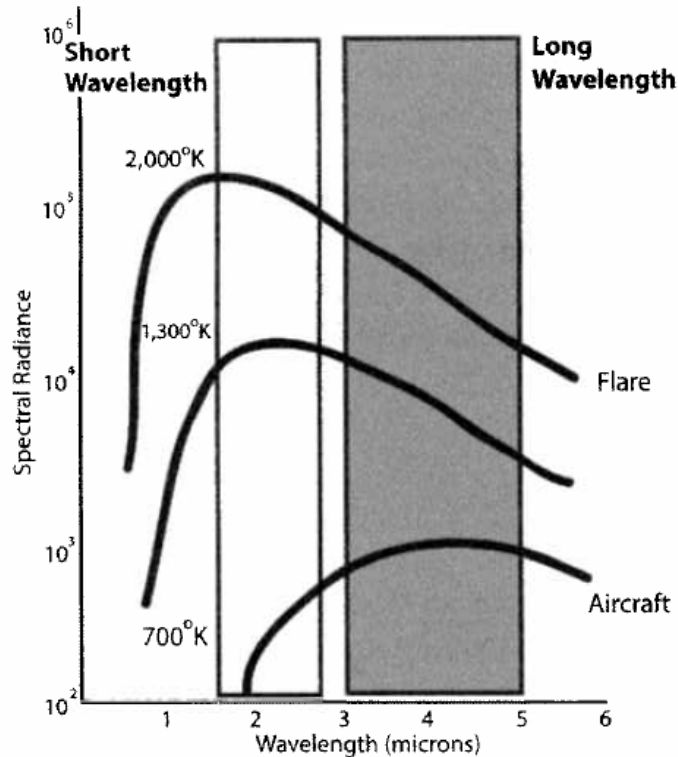

Figure 21. A Two-color Sensor can Determine the Temperature of its Target by Comparing the Energy at Two Frequencies [From 43].

#### (6) IRCM - IR Deceivers

IR deceivers introduce false target information to fool the IR tracker. This is done by using modulated IR signals in the sensor bandwidth. These modulated signals need energy levels that are higher than those from the aircraft the deceiver is protecting.

The IR deceiver requires information about the reticle modulation frequency of the missile it is trying to deceive. This can be measured by scanning the missile tracker with a laser and observing the reflected energy. Once the modulation frequency information is obtained, an erroneous pulse pattern can then be produced to

cause the missile tracker to produce incorrect steering commands. Following erroneous steering commands, the IR-guided missile will then fly away from the protected aircraft.

There are several sources of IR radiation that an IR deceiver can use, such as a xenon lamp, arc lamp, and heated ceramics (heated by electricity or aircraft fuel). The lamps can be pulsed to create amplitude modulated signals. Meanwhile, shutters can be installed over the heated ceramics and then exposed by following a pattern so as to produce a modulated signal. UAs with power constraints can choose ceramics heated by fuel.

(7) IRCM - IR Jammers

Similar to RF jammers, IR jammers produces large amounts of IR noise in the sensor bandwidth to saturate the IR detector. Some IR jammers are also able to damage the detector or the optics, causing the seeker to go blind. IR jammers typically are directed high-energy systems. An example of one would use a high-power laser to saturate or damage the seeker optics. As IR jammers can be laser countermeasures too, more will be discussed in the next section.

(8) Laser Countermeasure

Countermeasures against laser-guided threats can be broadly classified into active and passive countermeasures [43]. Active countermeasures include directing a high-power laser into the seeker's optics to either saturate the sensor or to damage it. A low-power laser can also be used instead to introduce erroneous signals into the guidance system and cause the threat to miss the UA. Passive countermeasures work by obscuring the target so that the adversary has difficulty tracking the target and maintaining proper aim using the laser. Smoke is an example of a laser countermeasure.

***b. Arm UA to Shoot at Incoming Threats***

As most UAs are not armed to dogfight another aircraft in the air, with the exception of an intentional collision, they pose no threat to an attacking manned fighter or helicopter. An attacking pilot can take his time to set his fighter up for an optimal shot



at the UA. However, if the UA is armed to fire back at the fighter, the pilot will be forced to launch his weapon at a longer range or from a less optimal position. This increases the possibility of the missile missing the UA.

During OIF, some Predators were armed with Stinger missiles. When an MIG-25 was sent to intercept one of these Predators, both aircrafts launched their missiles at each other. The dogfight ended with the Predator being killed when the MIG's missile found the Predator while the Predator's missile was diverted by the MIG's missile, thus missing its mark [44]. Though this example ended in failure, it showed the potential of a UA fighting back. If a UA can be armed with more lethal air-to-air missiles and are able to find their targets during engagements, the adversary commander will be forced to weigh the risk of losing a pilot sent to attack an unmanned aircraft versus the benefit of destroying the UA.

To enable this option, UA wings will likely need strengthening to withstand the load of the missiles. The wings will also need to be wired to send launch commands to the missiles.

## **5. Reduce Signature**

Small UAs can have large RCS that makes them easy to be detected by radars. Some UAs can have acoustic signatures that, even though can not be heard by unaided ears, can still be easily picked up by existing sound detection systems. Reducing signatures to make it harder for the threat system to detect, locate, and identify the UA is therefore important. Radar absorbent materials (RAM) can be applied to the UA to reduce radar echoes, existing engines can be replaced with engines that produce less heat, propulsion systems using propellers can be replaced with blades that produce less noise, and camouflage patterns can be applied to the UA to reduce its contrast with the surroundings so as to reduce visual radiations.

It is possible to reduce UA signatures without making any structural modification, neither requiring more power nor space. One example is the application of RAM to the

UA. Since smaller UAs typically have many size and power constraints, signature reduction must be considered as an enhancement option for smaller UAs, as this may be the only combat survivability enhancement option that is feasible to them.

## **6. Strengthen Damage Tolerance**

Ways to strengthen an existing UA to withstand damage (or reduce vulnerability) includes adding redundant critical components and installing them in separate locations, repositioning critical components to minimize exposure to threat, installing passive or active damage suppression components (such as self-sealing fuel tanks), shielding critical components with armor, and reducing parts count.

The degree of damage tolerance strengthening that will be applied is a function of UA size, cost, and operating environment. Therefore, it is unlikely that many vulnerability reduction features will be applicable to smaller UAs that are usually less expensive.

## **7. Improve Autonomy**

It is arguable that the "Achilles' heel" of a UAS is the requirement for communication between the UA and GCS. If the uplink (where commands are sent to the UA) is lost, the UA becomes a "headless" chicken. Most UAs are programmed to fly to a predetermined location should the communication uplink be lost for a predetermined period of time. This means that if the adversary is able to disrupt the communication uplink, the UA may not be able to perform its mission.

Therefore, one way to enhance the UA's combat survivability is to reduce or remove the UA's dependence on commands from the GCS. Autonomy of the UA can be increased. Some UAs like the Global Hawk and Herti are able to take off, fly to the target area, and land autonomously. There are already technologies in place for a UA to be programmed to perform basic mission functions such as maintaining persistent surveillance over a target area. To increase the autonomy of existing UAs requires software changes to both the UA and GCS and installation of flight measurement equipment with higher fidelity so that the flight status can be determined more accurately.

## **8. Redundant Navigation Systems**

Many UAs, due to space and weight constraints, install only one type of navigation system, with the most common type being Global Positioning System (GPS). GPS offers accurate navigation but is dependant on satellite signals that can be jammed. Any denial of GPS service will affect the mission effectiveness of the UA. It is therefore necessary to install another navigation system that uses a different technology as backup.

A prime candidate is the Inertia Navigation System (INS). The INS is a passive system and does not require another system to measure its position. It finds its current position by calculating the linear displacements from a last known position. However, INS has a position error (i.e., drift) that builds up over time. As the elapsed time of the operation increases, the position information generated by the INS becomes less accurate. The position errors can be corrected periodically with readings from the GPS (when it is not jammed). Regardless of its shortcomings, the INS is still a feasible backup system that provides reasonably accurate position information when the GPS is jammed.

Other alternatives include navigation using a compass and radio navigation using a data link. An electrical compass can provide heading information to the UA mission computer (for autonomous flight) and operator. A data link can be used to determine the position of a UA by measuring its azimuth and range from the GCS antenna.

The installation of a backup navigation system will be limited by the weight, space and power constraints of a UA. Careful trade studies must be made to consider the level of threat to the navigational system, importance of accurate navigation, and impact of a backup system on mission performance.

## **B. PAYLOAD**

Like the UA, payload is also susceptible to threats, even though it is more likely that an adversary will attack the UA instead of targeting only the payload. Payloads are susceptible to electronic attacks. Lasers can be shined into the optic sensor to temporarily “blind” the detector (permanent damage is possible if the dwell time is long

or the laser energy level is very high). Noise jamming techniques can be used against radars and communication relay systems so as to degrade their performance or even deny their usage. There is a need for the payload to apply self-protection against such threats.

An optical sensor can be protected by controlling the amount of transmitted energy into the detector. The light level to the detector can be monitored by a sensor which in turn will activate a modulator or shutter to protect the detector from excessively strong light levels. This is similar to a person's eyelids protecting his or her eyes from strong lights. Another method is to use narrow-line spectral filters [45]. These filters can be placed in front of the lens of the optical sensors to block rays of certain frequencies. However, the laser wavelength needs to be known for this protection method to work well.

Sensor performance also has an effect on the combat survivability of UAS, especially the UA. For most optical sensors, the aperture sizes determine the standoff distance between the UA and the target (and threats). There have been many cases where a UA needs to fly low for better electro-optical and infrared imagery [46]. The curves in Figure 22 represent the minimum aperture sizes that are consistent with being able to perform a given perceptual function at a specified range for various sensors.

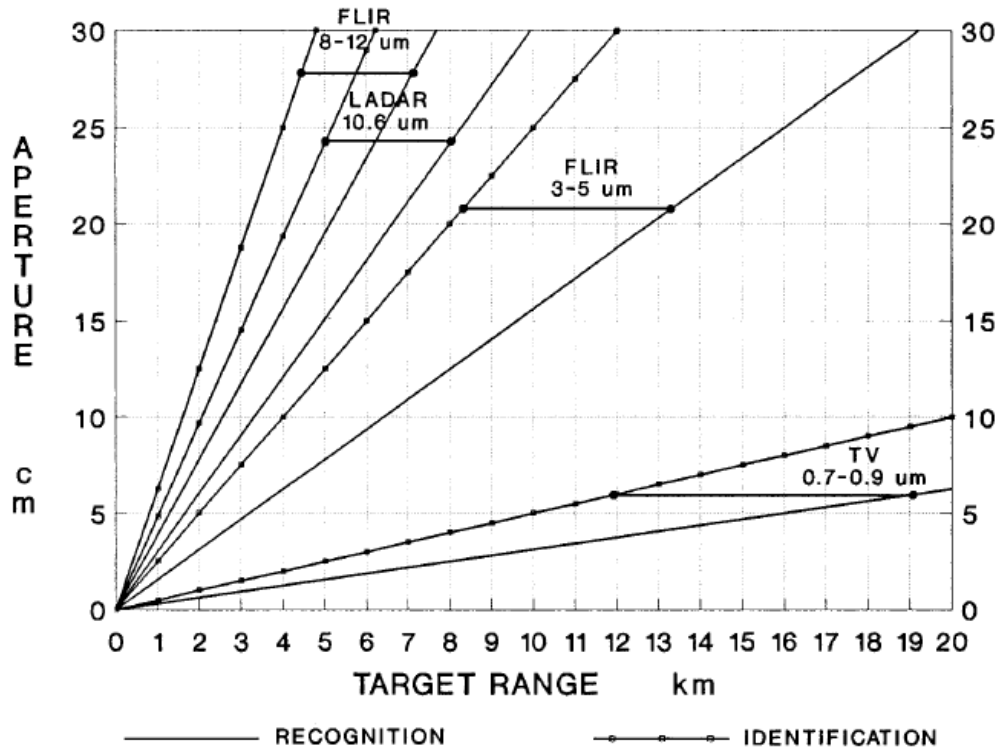

Figure 22. Aperture Size Requirements for Different Sensors and Imaging Functions [From 47].

The returns (in terms of enhancing UAS combat survivability) gained from replacing existing sensors with better performing ones will likely be more than if only payload protection is implemented. As sensor technologies improve over time, this enhancement option will become more affordable and feasible.

### C. GROUND ELEMENT

Even though GCS is part of UAS, the UA is often the focus of any UAS survivability discussion, thus neglecting the GCS. The GCS plays an equally important role in a UAS and its combat survivability should not be neglected. The ground components of a UAS are usually less well-defended [27]. Considering the importance of the GCS, it is therefore a priority target for an adversary aiming to disrupt or destroy a UAS.

The best way to ensure combat survivability of the GCS is to prevent the adversary from locating the GCS. There are several ways that the adversary can gather intelligence on a GCS location. One way is to use radio direction-finding techniques. As most UAs require constant communication with the GCS, adversaries can detect the communication signals and employ direction-finding techniques to locate the GCS. Once the GCS is located, the adversary can either capture the GCS by force or destroy it with bombardments.

Methods to reduce the likelihood of an adversary locating the GCS include reducing the probability of intercept of the communication channel, minimizing communications between the GCS and UA (i.e., by increasing the UA's autonomy as discussed earlier), and locating the ground data terminal remotely (e.g. the EL/K-1861 GDT can be located up to 5 km away from the GCS).

Redundant ground control stations should also be deployed at different locations, distances apart. Each GCS should have the capability of taking over control of the UA if a GCS is attacked or destroyed. It is therefore important that each GCS is able to maintain communication coverage over the entire area of operations (either by direct LOS or through satellite communications).

Another option is to position the GCS outside the reach of the threat. The mission control element of the Global Hawk is located at Beale Air Force Base, California while the UA is performing its mission over Iraq, more than 7,000 miles away. Being located outside the operation theatre makes it extremely difficult for any adversary from Iraq to attack the GCS. This option, however, requires a communication relay (e.g., satellite) as it is unlikely that direct LOS communications can be established at such long distances. This increases the cost of operating UAS, and there may be delays in the communication channel due to retransmission. The impact of this delay on performance needs to be considered. This option also introduces a new point of failure (the relay) into UAS. There may be a need to enhance the combat survivability of the relay so as to enhance the overall combat survivability of UAS.

As mission planning and controlling of the UA are performed using software, it is important that the software be free from viruses, Trojan horses, and other hostile software agents. Proper computer security techniques and policies, such as installing firewalls and scanning every software program for malicious agents before installation, should be practiced at all times.

Likewise, other ground elements, such as ground support equipment (GSE), has to be protected like the GCS to enhance their combat survivability. There is usually little or no redundancy for the GSE. If the GSE is damaged or destroyed, it may be impossible to recover a returning UA, repair a damaged UA, or even launch a UA for its next mission. The success of the campaign is thus affected. One option to protect the GSE is to locate the equipment far from the GCS. This will help to reduce the likelihood of collateral damage to the GSE should the GCS be attacked and vice versa. This option, however, will increase the cost of defending the ground element as more troops will need to be deployed to different locations.

#### **D. DATA LINK**

Data links are arguably the "Achilles' heels" of UAS. Adversaries using radio direction-finding techniques can locate the GCS and UA. They can jam the data links to degrade the communication channel between the GCS and UA, thus preventing the GCS from receiving real-time information from the UA. Adversaries may also use deception techniques to take control of the UA (by intruding the uplink) or send false signals to the GCS (by acting like the downlink). Through deception, the adversaries may either command the UA to crash or give false status of the UA such that the operator will command the UA to descent until it crashes. There may be a need to incorporate protection features into existing data links to enhance the overall combat survivability of UAS. Features such as low probability of intercept (LPI), encryption, resistance to jamming, and resistance to deception can be considered.

##### **1. Low Probability of Intercept**

LPI reduces the likelihood of an adversary locating the GCS or UA through radio direction-finding techniques. It is highly desirable for the uplink to have LPI

characteristics as the GCS, being stationary during operation, is easier to locate than the flying UA. LPI can be provided by frequency spreading, frequency agility, power management, and low duty cycles. In order to have the LPI characteristic, communication equipment on both the GCS and UA may need to be replaced. The power, space, and weight constraints of the UA limit the amount of communication equipment with LPI characteristics that can be installed on the aircraft.

## **2. Encryption**

Data links may be encrypted, but often are not. Encryption makes it difficult for the adversary to understand the information when he is listening in on both the uplink and downlink. If an adversary is able to intercept and understand the information exchanged between the GCS and UA, he or she may be able to use the information to fool the UA with bogus commands. Encryption of the data links would reduce the possibility of successful interception and exploitation. However, other than the above reason, encryption has little value in enhancing the combat survivability of UAS. Uplink commands are real-time oriented and difficult for the adversary to exploit before they become stale. No doubt that understanding the exchanged information may allow the adversary to locate the UA or know its next position, the adversary would more likely locate the UA through other sensors (like radars). There are other enhancement options that can make the data links more resistance to deception. This will be discussed later. The requirement to encrypt the data links will likely be more driven by operational security than by combat survivability.

## **3. Resistance to Jamming**

No “jam resistant” data link is likely to be simple, operate in real-time, and have high-bandwidth. Jam resistance is typically achieved by increasing the data link’s tolerance to jammer power before its operation degrades below an acceptable level. This can be achieved by increasing either the transmitter power, antenna gain, or processing power.



**a. *Increasing Transmitter Power***

Increasing the transmitter power is the brute way of overcoming jamming. The aim is to generate more radiating power so as to beat the jammer in a power contest. This is akin to someone in a noisy market shouting above the crowd so that he can be heard. To increase the transmitter power, more electrical power needs to be generated. Though this is achievable by a ground-based transmitter (by installing more generators), the space and weight constraints on a UA will likely make this option impossible. This is therefore the least useful and feasible option for a UAS.

**b. *Increasing Antenna Gain***

Another way to achieve the benefits of a high-power transmitter is to focus as much radiation as possible in the same direction. This is done to increase the antenna gain. At the transmitter end, the antenna gain concentrates the signal power into a narrow beam before directing it at the receiver. It is necessary that the transmitter antenna is facing the receiver so that the transmission can be narrow. The effective radiated power from such an arrangement is higher than that from an omni-directional antenna, thus increasing its likelihood to beat the jammer in the power contest.

Gain at the receiver antenna discriminates between signal and jammer energy based on the directions from which the energy arrives at the antenna. This is illustrated in Figure 23. The communication signal will experience the full gain of the main beam of the antenna ( $G_S$  in Figure 23) if the receiver antenna is pointed directly at the transmitter antenna. The signal from a jammer antenna that the receiver antenna is not pointing directly at will experience only gain in a side lobe of the receiver antenna ( $G_J$  in Figure 23). As the gain in the main lobe is much higher than gain from the side lobe, the wanted signal is therefore enhanced over the jammer signal by a factor of  $G_S/G_J$ . This factor is dependent on the exact angles of arrival of the jammer energy and the structure of the side lobes of the antenna. It is to be noted that this difference in gain will diminish as the jammer gets into the same line-of-sight between the UA and GCS (or any relay station).

Steerable antennas and tracking systems have to be installed so that the transmitter antenna can be pointed at the receiver antenna at all times. Installation of a steerable antenna on the UA may add weight and affects the aerodynamics of the UA. To have a high gain, the antenna needs to be big. Due to space constraints of the UA, the airborne antenna may not be big enough to have much gain.

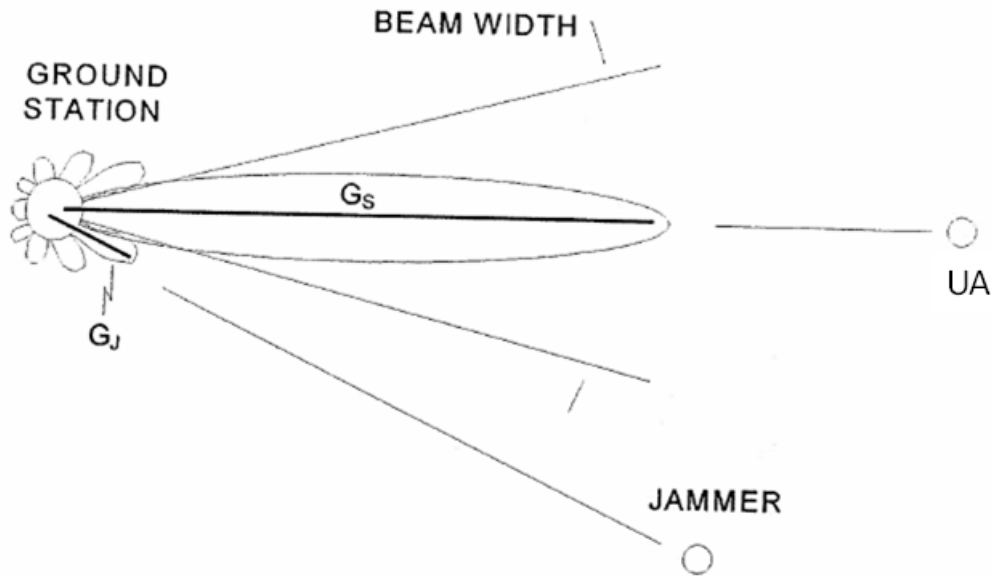

Figure 23. Illustration of the Geometrical Discrimination Between a Signal and a Jammer Using a High-Gain Antenna ( $G_S$  and  $G_J$  are the Gain for the Desired Signal and Jammer Respectively) [From 14].

Where LOS can not be maintained between the UA and GCS, there is a need for a relay station. This relay station may be a satellite, another airborne asset, or a ground asset. The requirement of a relay station means great cost increase in increasing antenna gain to enhance jam resistance of the data link.

*c. Processing Gain*

Processing gain refers to enhancement of the signal relative to the jammer that results from forcing the jammer to spread its power out over a bandwidth that is greater than the information bandwidth of the signal communicated by the data link [14].

This is achieved by either direct spread-spectrum transmission or frequency hopping. Communication equipment on existing UAS may need to be replaced so as to achieve such capabilities.

Processing gain, however, has the disadvantage of reducing data rates. To get 30 dB Anti-Jam Margin<sup>5</sup> downlink through processing gain, the transmission data rate needs to decrease from 10 MHz to 100 kHz [14]. Methods such as data compression and data truncation need to be applied to reduce the data rate.

*d. Discussion About Jam Resistance*

As can be seen to enhance jam resistance for the data link, antennas, communication equipment and power generators may need to be replaced. Weight, space, and power constraints of the UA are drivers for an airborne data terminal on the UA. The GCS, on the other hand, has less of such constraints, though antenna size and pointing requirements may have an impact on the configuration of the station.

*e. Reducing Impact of Data Link Jamming*

It is unlikely that the UA will be jammed everywhere all the time. There will be windows of opportunity for the data terminals to transmit. If UAS is not able to resist jamming by the adversary, operating policies can be changed to allow UAS to operate in a degraded mode when jamming occurs. When the data link is jammed, the UA may continue to perform its pre-programmed mission profiles and record all sensor data onboard the UA. This data can then be sent when jamming stops or the effects of jamming decreases. Alternatively, the UA can bring the data home on tape. A recorder needs to be installed on existing UAs to record the data. Software may need to be modified to allow the UA to perform missions autonomously. This option, however, is not feasible if the mission requires real-time information.

---

<sup>5</sup> A measure of the amount of jammer power the data link can tolerate before its performance becomes unacceptable.

#### **4. Resistance to Deception**

Deception is arguably more damaging than jamming as it can lead to the loss of the UA, while jamming typically only denies the performance of a particular mission. The UA only needs to be tricked into accepting one catastrophic command such as 'stop engine', 'pitch down' (to crash into the ground), etc. An operator can also be tricked to crash the UA when the adversary successfully sends false status signals showing that the UA is climbing, causing the operator to command the UA to descend.

Resistance to deception can be provided by authentication codes and some of the techniques that provide resistance to jamming, such as spread-spectrum transmission using secure codes. The advantage of using authentication codes is that it can be implemented without installing any new equipment. Codes can be generated and verified by the system computers. Only the software needs to be modified for the computers to perform this task.

#### **E. OPERATOR**

Another important component of UAS is the human operator. It is no surprise that human factors affect the combat survivability of UAS. As an example, as high as 17 percent of UAS accidents during OEF and OIF were due to human factors [48]. Seventy-one percent of Predator accidents between 2003 and 2006 could be attributable to human errors [49]. Though UA operators are not placed in immediate danger as the UA is executing its mission, they often see the gruesome details of how an adversary was taken out (used to be something only soldiers who were involved in close combats got to see). UA operators therefore are subject to combat stresses too [50]. Combat stresses and other human factor issues such as poor GCS console designs and operation polices to

ensure safe handing over of UA control from one set of crew to another<sup>6</sup>, limited situational awareness due to operator controlling the UA remotely, etc. have led to numerous accidents.

In order to enhance UAS combat survivability, these issues need to be overcome. More training, better counter-checks, more crew rotations, etc. may be solutions to some of the human factor issues. As human factor issues are solved, the likelihood of human factor-related accidents will decrease and thus improve combat survivability.

## **F. CHAPTER SUMMARY**

Due to the wide range of sizes and performances of UAs, a standard “one size fits all” solution to UA combat survivability is not available. Many of the combat survivability enhancement options can only be implemented on the larger UAs.

Combat survivability enhancement options have been identified to include changing tactics (increasing the operating altitude or changing the operating speed of the UA), improving situational awareness of the operator (installing threat warning systems), equipping the UA to counter incoming threats, improving payload performances, improving the data link resistance to jamming and deception, and solving human factor issues. A proposed process for selecting the “best” combat survivability enhancement solution is presented next.

---

<sup>5</sup> The National Transportation Safety Board reported that on the April 26, 2006, a Predator B crashed due to poor human factors when a UA control was switched. According to the report, when the pilot was switching from one console to another, he inadvertently cut off UAS’s fuel supply. When the switch was made, a lever on the second console remained in a position that would cut off the fuel supply if the console was used to control the aircraft. Although procedures required that the controls on the two consoles be matched prior to making such a switch, this procedure was not followed.

## **VII. SELECTING COMBAT SURVIVABILITY ENHANCEMENT SOLUTIONS FOR AN EXISTING UAS**

UAS combat survivability is a balance of the Concept of Operations (CONOPS), tactics, technology, and cost for a given threat environment [7]. There is a need to balance between making UAS survivable and meeting other UAS objectives. This is demonstrated in the failure of the RQ-3 DarkStar program. The RQ-3 DarkStar was designed with stealth design to make it highly survivable. It was optimized to perform missions in heavily defended areas. The DarkStar was to complement the RQ-4 Global Hawk. The Global Hawk was designed to be moderately survivable and optimized to perform missions that required long range and endurance but in a low-to-moderate threat environment.

In an attempt to meet its cost objective of a \$10 million flyaway price (which it failed to meet eventually), performance was traded. The DarkStar has shorter range and endurance than the Global Hawk (9 hours at 500 nm versus 24 hours at 1200 nm). The data link on the DarkStar has less bandwidth than the Global Hawk. The DarkStar can only carry either the radar or the EO payload at any time, while the Global Hawk can carry both payloads simultaneously. Both of the DarkStar's payloads also have slightly less capability than the Global Hawk's payloads. The resultant DarkStar design traded performance for survivability.

The DarkStar program was eventually cancelled for reasons that included its performance shortfall outweighing the perceived value of its enhanced survivability. Given a trade-off between survivability and performance, the USAF chose the performance of the Global Hawk over the Dark Star's survivability.

Among the many reasons for operating a UAS (versus manned aircraft) are that UAs typically have longer range and endurance and lower operating costs. The performance and cost of UAS should not be traded for combat survivability by so much so that the shortfall outweighs the perceived value of the combat survivability (as in the case of the DarkStar program). A balance between the requirements must be achieved.

A process is therefore needed to be put in place to help decide whether it is necessary to enhance the combat survivability of an existing UAS and, if necessary, which combat survivability enhancement feature(s) to select.

**A. ESTABLISH THE NEED TO ENHANCE COMBAT SURVIVABILITY**

First, the need for enhancing combat survivability of UAS has to be established. The need is dependent upon many factors. It includes the types of mission to be accomplished, the criticality of these mission(s), the threats encountered by UAS in its operating environment, and the number of UAS available, taking into account the UA as well as the payload. UAS with minimum combat survivability features may be sufficient to perform non-critical missions in low threat environments. If a large fleet of expendable UAS is available, missions can still be accomplished at lower life-cycle costs, even if one or more of the less survivable assets is destroyed. However, if UAS is to perform critical missions in a high threat environment, better combat survivability may be required. Likewise, if few UAS are available, every UAS is more valuable to the mission, and therefore it is more important that UAS can survive the hostile environment.

The need to enhance combat survivability of an existing UAS may also be based primarily on economic considerations. There can be a trade-off done between replacement cost and cost of enhancing the combat survivability. The replacement cost should include both the actual cost of UAS components being replaced and logistic costs incurred to carry out the replacement. Ignoring any other factor, it makes perfect economic sense to adopt the lower cost option.

Another factor to consider is the life span of UAS. If UAS is near the end of its life span, it may not be worthwhile to enhance its combat survivability as there is little number of years left to reap the benefit. Inputs to help determine the need for enhancing combat survivability of UAS should be solicited from the customers. The customers include field commanders, units that UAS support, service planners.

Questions that can help establish the need include:

- What is the type of mission(s) conducted by UAS? How critical are these missions? What is the contribution of UAS to overall mission success?
- What is the type of threat UAS will face in its area of operations? What is the threat level in the area of operations?
- What is the current combat survivability of UAS? Are current combat survivability features of UAS sufficient to counter the threat?
- How is the combat survivability of UAS affecting overall mission success? Is it acceptable? Considering the attrition rate, are there sufficient UAS to perform the missions?
- What is the cost of replacing destroyed components of UAS?
- Is it better<sup>7</sup> to procure more of the same UAS without enhancing the combat survivability, or is it better to enhance the combat survivability? Alternatively, will it be better to use a different type of UAS, which may be cheaper but more in numbers or is more survivable, to perform the mission?
- How many years are left of UAS lifespan? Is the number of serviceable life left for UAS justifiable for a survivable enhancement?

## **B. FEASIBILITY ANALYSIS**

After determining the need for combat survivability enhancement, the next steps are to (1) identify possible top-level approaches that can meet the need; (2) evaluate the approaches in terms of effectiveness, impact on the existing UAS, maintenance and sustaining support requirements, associated risk (technological, schedule, program, etc.), and life-cycle costs; and (3) select the preferred approach [51]. It is possible to have more than one approach selected. Designs based on the selected approach(s) will be developed and evaluated further down the process.

It is important that all alternatives are included in the analysis even if it seems unlikely that these alternatives will prove to be feasible. This is because alternatives that are not considered can not be adopted, regardless of how desirable they may be, so it is better to consider many alternatives than to overlook one that may be good.

---

<sup>7</sup> The definition of “better” is dependent on the measurement used by the decision maker. It can be in terms of cost, in which case, the cheaper the solution is, the better it is. It can also be in terms of time required to implement a solution versus urgency of the problem; if it is important to have a solution as soon as possible, the “better” solution may be the one that requires a shorter implementation time.



### **C. IDENTIFY OBJECTIVES AND DEFINE REQUIREMENTS**

The next step is to identify objectives and define the requirements<sup>8</sup> for enhancing combat survivability. The objectives are to be solicited from the customers. Requirements are then defined based on the objectives.

There may be numerous different objectives identified. The integrator/designer and project manager need to know which objective is more important than the others. This is especially necessary if a trade-off or compromise must be made in order to meet a higher-level requirement. A tool that can be used to help establish and prioritize the requirements is the analytic hierarchy process (AHP). The AHP provides a framework to relate the requirements to the overall goals (objectives). The AHP can facilitate the prioritization of the set of requirements and gives the relative weights of each requirement. These weights aid the selection of enhancement solutions later in the process.

Technical measures are to be developed so as to estimate, predict, and/or measure the system performance and effectiveness. Technical measures provide insights into the progress of defining and developing the design, assessment of associated risks, and the degree of meeting the objectives. These insights help project managers make better decisions to increase the probability of delivering a design that meets the needs and requirements. Such insights also aid decisions when trade-offs are to be made [52].

Technical measures include measures of effectiveness (MOE), measures of performances (MOP), and technical performance measures (TPM).

Some MOEs include:

- Loss rate
- UA endurance and range
- Coverage over target area
- Availability

---

<sup>8</sup> Objectives are goals while requirements are important attributes or characteristics of the system. For example, the objective of enhancing the survivability of a UAS is so that the UA can survive a hostile environment. The requirement for this is that the UA must have a probability of hit of less than 1%.

#### **D. FUNCTIONAL ANALYSIS**

In order to identify all the resources (or physical components) necessary for the system to accomplish its mission, a functional analysis is performed. A function is a specific or discrete action (or a series of actions) that is necessary to achieve a given objective [51]. A functional analysis is an iterative process. It breaks the system level function into its constituent parts, and the constituent parts into their respective constituent parts, so on and so forth until a level whereby the input design criteria and/or constraints for the various elements of the system can be identified. The functional analysis presents an overall integrated and composite description of the system's functional architecture, and provides a foundation from which all physical resource requirements are identified and justified.

A functional analysis also ensures that only necessary resources are considered and no unnecessary resources are requested. This is especially important to UAS with weight and power constraints. Only combat survivability enhancement features that are applicable to the likely threat environment should be considered. For example, the RQ-4A Global Hawk flying at 65,000 ft has minimal exposure to surface-to-air missiles (SAM) that uses IR for guidance. SAM threats at such a high altitude mostly use radar for guidance. For combat survivability, the aircraft's modular self-defense system, therefore, includes only an AN/ALR 89 radar warning receiver, an on-board jamming system, and an ALE 50 towed decoy system [53], but no IR countermeasures. By not installing unnecessary combat survivability features, more payload volume and electrical power can be allocated to its payload sensors.

#### **E. FUNCTIONAL AND REQUIREMENTS ALLOCATION**

Having identified all the resources needed for the system to accomplish its mission, the next step is to map all functions to physical components. In order to save weight, size, and (hopefully) cost, similar or closely related functions may be packaged together to employ common resources. For example, the function of releasing flares can be grouped together with the function of releasing chaffs and allocated to the mission computer.

When allocating functions to physical components, different design approaches that can satisfy a given functional requirement are to be evaluated. Trade-off studies are to be performed. A function may be performed by various components (hardware, software, human, etc., and/or their combinations). A proper mix is to be chosen.

Top-level requirements defined earlier are also to be broken down and allocated to the individual components. For example, if an EW system consisting of a MWS subsystem and flare dispensers requires an operational availability ( $A_o$ ) of 90%, the MWS subsystem will require an  $A_o$  of 94% while the dispensers will require 96%  $A_o$ .

#### **F. EVALUATE COMBAT SURVIVABILITY ENHANCEMENT SOLUTIONS**

Having justified the needs, identified the components required, and allocated functions and requirements to each component, the next step is to look for and evaluate combat survivability enhancement solutions. Each solution may incorporate one or more combat survivability enhancement features. For example, one solution may simply propose applying radar energy absorbent paint over the UA while another solution may propose installing a RWR system and a towed RF decoy system instead.

Depending on criticality, urgency, and budget allocated to enhance combat survivability, solutions of varying technical maturity can be sought. If the enhancement is to be implemented in the shortest possible time, existing enhancement features should be sought. However, if the requirement is not urgent and there is sufficient budget allocated, features utilizing developing technology can be sought.

If an enhancement solution does not negatively affect performance, maintenance, cost, weight, or any other UAS attributes, it should be adopted. However, if the solution affects one or more of these attributes, further study is required. The pros and cons of each solution are to be studied. Factors to consider include (1) effectiveness of the solution; (2) how the solution will affect UAS performance, reliability, maintainability, supportability and system safety; (3) cost of the solution; and (4) schedule.

### **1. Effectiveness of Solution**

It is important that the effectiveness of the solution in enhancing combat survivability is assessed as an ineffective feature installed is a deadweight (excess baggage) to UAS. The definition of effectiveness is dependent on the success criteria set by the customer. MOEs are used to measure the effectiveness. MOEs will allow the evaluation of the degree of combat survivability enhancement each features achieves. Various alternatives can then be compared. Methods to measure the effectiveness of each feature in enhancing combat survivability include engineering studies, actual testing, modeling, and simulation.

### **2. UAS Performance**

It is very likely that the enhancement solution will affect the performance of existing UAS. For example, installing a RWR system onto the UA will increase the UA's weight and may increase the fuel consumption, resulting in a decrease in the UA's endurance, and encrypting the data link to increase communication security leads to a decrease in data rate. As discussed at the beginning of this chapter, there is a need to balance the requirement for combat survivability with the requirement for performance. If implementing the combat survivability solution will adversely affect mission effectiveness, UAS may be better off without the enhancement. Surviving the hostile environment without performing the mission is probably worse than accomplishing the mission but not surviving the hostile environment.

### **3. Reliability**

Reliability is the ability of UAS to perform its required functions for the required duration. The introduction of combat survivability enhancement features may affect the reliability of UAS. When components are added as part of a combat survivability enhancement, additional sources of failures are introduced into UAS. The overall reliability of UAS will be degraded. However, if the failures of these new components are isolated and do not lead to secondary failures on existing components in UAS, the current mission reliability is not affected.

Reliability also affects the logistic burden. A UAS with poor reliability will require more spares and more frequent maintenance (both corrective and preventive). This puts a strain on logistics support, operational effectiveness, and mission planning. It is therefore important that the benefits of combat survivability enhancements outweigh the effect on UAS reliability.

#### **4. Maintainability**

The addition of combat survivability enhancement features to an existing UAS will affect the maintenance requirements of the system. In most cases the maintenance labor-hour requirements for the system will likely increase. For example, more preventive and corrective maintenance requirements can be expected when EW equipment is added to UAS. The opposite case may exist too. When components are reduced as part of an effort to reduce vulnerability or combat survivability is enhanced through software changes (i.e., encrypting the data link), the maintenance man-hour requirements may actually drop. The enhancement must not affect UAS maintainability so negatively that the cost outweighs the benefits of a combat survivability enhancement.

#### **5. Supportability**

A UAS requires logistic support in order to perform its missions. UAS requires fuel to operate, spares to replace failed components, GSE to launch and recover the UA, etc. It is necessary to assess the impact of combat survivability enhancement solutions on UAS supportability. For example, installing a RWR system onto the UA will increase the UA's weight and may increase the fuel consumption; this implies that more fuel will be needed to bring the UA to the operating base. This may cause a strain on the logistic chain. The gains from combat survivability enhancements have to outweigh the logistic burden added onto UAS.

#### **6. System Safety**

Probable change in UAS system safety by survivable enhancement solutions must also be assessed. In some cases, combat survivability enhancements (such as reducing vulnerability) may improve the system safety of UAS. For example, a fire suppression

system in the fuel systems can reduce the likelihood of the UA being destroyed by fire caused by both a natural and man-made hostile environment. However, in many other cases, the solution actually degrades the system safety. Once flare dispensers are installed on the UA, there is likelihood that operators may inadvertently release flares over cities. Any new hazards created by the implementation of the combat survivability enhancement solution must be identified and the associated risks must be reduced as much as possible to an acceptable level.

## **7. Dollar Cost**

The financial costs may be one factor that all trade-offs are based on. The budget is not limitless. If necessary, trade-offs in either performance or schedule are usually done in order to meet the budget. A cost analysis should be performed to estimate/predict the total cost of ownership (TCO). The TCO includes acquisition cost, integration cost, operation and support (O&S) cost (for both peacetime and wartime operations), and disposal cost. O&S cost typically accounts for the largest portion of the total cost [54].

The implementation of the combat survivability enhancement solution may increase the TCO of each UAS, but it also reduces the attrition rate of UAS. This implies that less UAS are needed to accomplish the same mission objectives. From a fleet-wide perspective, the overall cost of equipping, operating, supporting, and disposing of UAS may actually be lower. The cost of combat survivability enhancements may be greatly exceeded by the cost of UAS attrition.

## **8. Schedule/Time Line**

The estimated time taken to develop and implement the combat survivability enhancement solutions has to be assessed too. Only solutions with acceptable timelines should be considered. As contractors may provide excessively optimistic schedules, it is also important to assess the likelihood of contractors meeting their schedules.

Questions that may help in the evaluation of combat survivability enhancement solutions include:

- Is each solution applicable to the threat? How effective is each solution with respect to the threat?
- How will each combat survivability enhancement solution affect the operators in terms of workload, situation awareness, qualification required, etc?
- How will the combat survivability enhancement solution affect the UA performance in terms of its range, endurance, altitude, speed, agility, handling characteristics, balance and stability, loading on the airframe, electromagnetic interference (EMI) and compatibility (EMC) with other components, amount of payload the UA can carry, payload performance, electrical loading, communication between the UA and GCS, etc?
- How will the combat survivability enhancement solution affect the GCS performance in terms of EMI and EMC with other components, communication between the UA and GCS, mobility of the mobile control station, power loading, etc?
- How much modification (both hardware and software) on the existing UAS is required? Is the complexity of the modification and associated risk acceptable? Is the length of time required for the modification acceptable?
- How will the combat survivability enhancement solution affect the support structure of UAS? Areas to be considered include spares requirements, requirements on technicians, additional GSE required, reliability and availability of UAS, etc.
- How will the combat survivability enhancement solution affect the system safety aspect of UAS? Have all hazards been identified? Can all associated safety risks be reduced to acceptable levels?
- What are the acquisition costs, operating and support costs, integration costs, etc. associated with implementing the enhancement? Are the costs acceptable?
- What are the risks associated with the combat survivability enhancement solution? Are the customer and/or the program manager willing to undertake the risk?

## **G. SELECTING THE COMBAT SURVIVABILITY ENHANCEMENT SOLUTION**

After evaluating each alternative combat survivability enhancement solution, it is now necessary to select the “best” solution. A benefit-cost analysis (BCA) can be performed to help select the “best” solution.

For the BCA, the net perceived benefit of the each solution is first determined. The net benefit is the advantage that the solution provides minus the burden (other than

cost) that the operator will have to bear for implementing the solution. For example, installing a RWR system on the UA gives the benefit of improving the operator's situational awareness; however, this also increases the logistic burden as the RWR system has to be maintained, the threat library has to be updated, etc. There are many techniques to measure the perceived benefits, which include using the AHP or modeling and simulation.

The definition of "best" depends on the customer's top criteria for enhancing UAS combat survivability. The customer may be asking for the most cost-effective solution, the solution with the least operational impact to the existing system, the solution with minimal cost, or the most beneficial solution that is within the budget, etc.

To identify the most cost-effective solution, the relative benefit of each solution is divided by its cost. The solution that gives the highest ratio (most benefit for each dollar invested) is the "best" solution.

A sensitivity study is also to be conducted on the benefit assessment to examine the stability of the decision due to changes in the variables (assigned weights and life-cycle cost elements). The resultant relative benefit ratios are then plotted in the benefit-cost chart. A more deliberate trade-off between benefit and cost assessment can then be made before recommending the most cost-effective system.

## **H. EXAMPLE**

A UAS with very few combat survivability features incorporated in its original design has become a candidate for combat survivability enhancement when its potential adversary upgraded its air defense capability. The selection process discussed earlier in this chapter will be used to determine the need to enhance combat survivability of UAS and to select the "best" solution. Unless otherwise stated, figures quoted in this section are fictitious.

UAS consists of one UA, one GCS, and other ground support elements. Its primary missions are ISR missions. The UA typically operates at medium altitude (10,000 to 15,000 ft) and has long endurance of about 20 hours. It is a MALE class UA



and is capable of carrying only one payload at a time. The primary mission payload consists of IMINT sensors such as FLIR and day TV, and SAR.

The GCS is in a shelter mounted on truck, which gives it mobility. The GCS and other ground support elements will likely be located away from the reach of the adversary threat. The data link between the UA and the GCS has a low probability of intercept and employs encryption techniques that ensure the security of the communication. The likelihood of the adversary jamming the data link or successfully employing deception techniques on the data link is minimal.

## **1. Establishing Needs**

The first step is to establish the need to enhance the combat survivability of UAS. The need to enhance combat survivability of UAS depends on, among many other factors, the types of missions to be accomplished, the criticality of these missions and the importance of UAS to these missions, the threat encountered by UAS in its operating environment, and current combat survivability.

### ***a. Importance of UAS***

UAS has become an important part of the defense doctrine. Commanders recognize the value of persistence surveillance made possible by the long endurance of the UA. The demand for UA flights has increased over the years. Coupled with the limited size of UAS fleet, it has become paramount that UAS survives hostile environments.

### ***b. Threat***

The adversary has recently acquired a new long-range radar system that is able to detect UAs from a longer distance. The adversary is also equipped with EO detectors that can identify and track the UA passively. UAS operator will not know that his or her UA is being tracked until the adversary shoots it down.

The adversary's hard-kill options consist of an arsenal of AAA, SAMs (both IR-guided and radar-guided), and aircraft that are capable of shooting the UA down. The AAA is effective up to about 10,000 ft. Some of the SAMs can reach 15,000 ft and above.

It has been assessed that the effectiveness of the adversary's soft-kill options is very limited. The probability that the adversary is able to locate GCS using radio direction-finding techniques is low, and it is unlikely that the adversary can jam the data link successfully. The adversary is also not known to possess the capability to launch EMP attacks.

*c. Current Combat Survivability*

Campaign models and simulations show that with the new threat from the adversary's radar, the loss rate for UAS is 0.05 kills for every 1,000 hours of operations. Considering how limited the size of UAS fleet is, this loss rate is deemed to be too high. Any loss is also assessed to be too expensive in terms of financial cost. There is definitely a need to enhance the combat survivability of UAS.

**2. Feasibility Study**

This is the step where possible top-level approaches to meet the needs are identified, assessed, and selected. To aid the identification of top-level approaches for consideration, shortcomings of UAS are first identified. The rationale is that to enhance combat survivability, one or more of these shortcomings should be remedied. One effective way to identify these shortcomings is to see things from the adversary's points of view. A team of experts can be gathered to play the role of the adversary to brainstorm how they will attack UAS and why they will do so. These reasons are UAS shortcomings. The same or another team of experts will then brainstorm on possible remedies to these shortcomings. These remedies are the top-level approaches to consider. Table 8 shows a list of UAS shortcomings and possible remedies.

Table 8. UAS Shortcoming And Possible Remedies

UAS Shortcoming	Possible Remedy
<p><b>Noisy</b></p> <ul style="list-style-type: none"> <li>• The propeller propulsion system is the main source of noise</li> <li>• Its presence can be detected from a great distance (especially if it is flying low)</li> </ul>	<ul style="list-style-type: none"> <li>• Provide thrust without using propellers</li> <li>• Minimize noise</li> <li>• Divert noise to travel away from adversary</li> </ul>
<p><b>Slow</b></p> <ul style="list-style-type: none"> <li>• The slow speed makes killing it easy with a large array of weapons</li> </ul>	<ul style="list-style-type: none"> <li>• Increase speed of the UA</li> <li>• Reduce probability of detection of the UA</li> </ul>
<p><b>Not agile</b></p> <ul style="list-style-type: none"> <li>• Can easily kill with aircraft, SAMs, and AAA</li> </ul>	<ul style="list-style-type: none"> <li>• Improve on the agility of the UA</li> <li>• Strengthen the UA's tolerance to damage</li> <li>• Reduce probability of detection of UA</li> </ul>
<p><b>Needs to fly low below clouds to obtain images</b></p> <ul style="list-style-type: none"> <li>• Can easily kill with AAA</li> <li>• Can easily kill with SAMs</li> </ul>	<ul style="list-style-type: none"> <li>• Upgrade the UA with the capability to see through clouds</li> <li>• Remove the clouds</li> <li>• Reduce the probability of detection of the UA such that it can not be detected even though it flies low</li> </ul>
<p><b>Operator has limited situational awareness</b></p> <ul style="list-style-type: none"> <li>• Operator has limited awareness (visual, aural, IR, and electronically) of what is happening around the UA</li> <li>• Can attack the UA from the direction that it is not seeing (sneak attack), especially when it is using its only optical sensor to perform a mission</li> </ul>	<ul style="list-style-type: none"> <li>• Improve the situational awareness of the operator</li> </ul>

<b>UAS Shortcoming</b>	<b>Possible Remedy</b>
<p><b>UA can not escape or fight back when attacked</b></p> <ul style="list-style-type: none"> <li>• UA has no means to shoot back at attacker</li> <li>• UA does not have a soft-kill option (jamming, countermeasure, etc.) against the adversary</li> </ul>	<ul style="list-style-type: none"> <li>• Increase speed and/or agility of the UA</li> <li>• Equip the UA with the capability to counter incoming threats</li> </ul>
<p><b>UA can not survive a hit</b></p> <ul style="list-style-type: none"> <li>• UA has no armor and therefore missile fragments or rounds can easily penetrate skin and damage critical components</li> <li>• UA has no fire suppression system to reduce damage when hit</li> </ul>	<ul style="list-style-type: none"> <li>• Strengthen damage tolerance</li> </ul>
<p><b>Will not be able to navigate as accurately if GPS is jammed</b></p> <ul style="list-style-type: none"> <li>• UA depends on GPS for navigation, therefore once GPS is jammed the UA will either need to navigate with degraded mode or not be able to navigate at all, which means that it will not be able to reach its target area; jamming GPS will disrupt other systems too (not only UAS), therefore from adversary's POV, this is very attractive</li> </ul>	<ul style="list-style-type: none"> <li>• Protect the GPS navigation system</li> <li>• Provide an alternative navigation system</li> </ul>
<p><b>Will fail the mission if the GCS is destroyed</b></p> <ul style="list-style-type: none"> <li>• UA is dependent on the GCS to fly the mission, so destroying the GCS means killing the UA too</li> <li>• UA needs to transmit what it sees to some station so that it can be interpreted and made useful; if the GCS is destroyed, whatever info the UA gathered will be useless as there is no one on the other side to receive the transmission</li> </ul>	<ul style="list-style-type: none"> <li>• Reduce the UA's dependence on the GCS</li> <li>• Reduce the likelihood of an adversary locating the GCS</li> <li>• Reduce the vulnerability of the GCS</li> </ul>

<b>UAS Shortcoming</b>	<b>Possible Remedy</b>
<p><b>Will be lost if there is no way to recover the UA (i.e., runway destroyed)</b></p> <ul style="list-style-type: none"> <li>• UA cannot fly indefinitely; If adversary can destroy means of recovering the UA, the UA will eventually be lost</li> </ul>	<ul style="list-style-type: none"> <li>• Provide an alternative recovery system or method</li> </ul>
<p><b>Will fail mission if sensor is destroyed as it only has one sensor</b></p> <ul style="list-style-type: none"> <li>• Since the UA has little redundancy, especially the mission's sensor, if adversary can destroy or degrade sensor performance, the UA will not be able to perform its mission</li> </ul>	<ul style="list-style-type: none"> <li>• Strengthen the sensor tolerance to damage</li> </ul>
<p><b>Susceptible to EMP</b></p> <ul style="list-style-type: none"> <li>• UAS has little protection against nuclear EMP or high power microwave EMP</li> </ul>	<ul style="list-style-type: none"> <li>• Minimize susceptibility of UAS to EMP</li> </ul>
<p><b>Is not able to react to a situation without operator's input</b></p> <ul style="list-style-type: none"> <li>• Will fail the mission when data link with the GCS is lost, so the adversary can jam the signal, destroy the rebroadcast station (if it does not depend on LOS communications), etc.</li> </ul>	<ul style="list-style-type: none"> <li>• Reduce the UA's dependence on the operator</li> <li>• Improve on the data link's resistance to jamming</li> </ul>
<p><b>Depends on communication link with the GCS</b></p> <ul style="list-style-type: none"> <li>• Will fail the mission when communication link with the GCS is lost</li> <li>• The GCS can be detected using direction-finding equipment and attacked using artillery, anti-radiation munitions, etc.</li> <li>• Link can be intercepted and exploited, deceived, and jammed (intentionally and unintentionally)</li> </ul>	<ul style="list-style-type: none"> <li>• Improve on communication security</li> <li>• Provide an alternative communication channel</li> <li>• Reduce the data link's probability of intercept</li> <li>• Improve the data link's resistance to jamming</li> </ul>
<p><b>Operator can only see what the UA sees</b></p> <ul style="list-style-type: none"> <li>• Blind sensor -&gt; operator can not perform mission</li> </ul>	<ul style="list-style-type: none"> <li>• Strengthen the sensor's tolerance to damage</li> </ul>

<b>UAS Shortcoming</b>	<b>Possible Remedy</b>
<ul style="list-style-type: none"> <li>• Feed false signal to sensor -&gt; operator "sees" what adversary wants him to see</li> </ul>	<ul style="list-style-type: none"> <li>• Improve the resistance to deception by an adversary</li> </ul>
<p><b>Ground support facilities not well defended</b></p> <ul style="list-style-type: none"> <li>• Can be easily attacked</li> <li>• usually has least redundant component, therefore cannot be replaced easily</li> </ul>	<ul style="list-style-type: none"> <li>• Strengthen the defense of the ground element</li> <li>• Reduce the probability of detection of the ground element</li> <li>• Move the ground element to outside</li> </ul>

*a. Feasibility*

All the top-level approaches to combat survivability enhancements are considered and evaluated for their feasibility. Factors considered included effectiveness of the approach to enhance UAS combat survivability, possible impact the approach would have on the existing UAS, maintenance and sustaining support requirements, associated risk (technological, schedule, program, etc.), and life-cycle costs.

In this example, it is determined that improving the operator’s situational awareness and equipping the UA with the capability to counter incoming threats are feasible approaches to enhancing the combat survivability of UAS. It is also assessed that it is technologically possible to equip the UA within an acceptable timeline while keeping the cost within budget. Combat survivability can be enhanced without affecting much mission effectiveness.

**3. Objectives and Requirements Defined**

The objective is identified as to enhance UAS combat survivability without sacrificing much performance. Keeping the objective in mind, quantitative and qualitative requirements for the combat survivability enhancement solution are developed. The requirements include:

- **Effectiveness:** The UA loss rate must decrease from 0.05 kills for every 1,000 hours of operations to at least 0.03
- **UAS Performance:** The maximum endurance of the UA should be at least 15 hours
- **Compatibility:** The combat survivability enhancement solution should have minimal interfere with the operation and performance of existing payload
- **Availability:** The inherent availability of UAS should be at least 85%

AHP is used to priorities the various requirements. The resultant weightages are used when selecting the enhancement solutions later in the process. Figure 24 shows the comparison matrix for the requirements.

	<b>Effectiveness</b>	<b>Performance</b>	<b>Compatibility</b>	<b>Availability</b>	<b>Weights</b>
<b>Effectiveness</b>		3	2	3	0.4314
<b>Performance</b>			1/3	3	0.1776
<b>Compatibility</b>				2	0.2807
<b>Availability</b>					0.1102

Figure 24. AHP Comparison Matrix for the Requirements.

As can be seen in Figure 24, it is most important to decrease the UA loss rate, followed by the combat survivability enhancement solution being compatible with the payload, followed by the effect of the solution on the UA’s maximum range, and lastly the effect on the UA’s operating altitude.

The primary MOE developed for the objective is loss rate. Loss rate is defined here as the number of UAs killed per 1,000 hours of operation.

#### 4. Functional Analysis

The function of countering an incoming threat is next decomposed to identify all resources or physical components needed to accomplish the task. The decomposition of the function “to counter an incoming threat” and the associated physical components for each sub-function is presented in Table 9. It is to be noted that physical components can

include humans. As can be seen in the figure, many functions require the same physical component. This provides the opportunity to package multiple functions together to employ the same component.

Table 9. Functional Decomposition of “To Counter Incoming Threat” and Physical Component Identification

<b>Function</b>		<b>Physical Components</b>
1.0	To Counter an Incoming Threat	
1.1.0	Detect and identify an incoming threat	
1.1.1	Provide coverage in the direction that the threat will likely come from	RWR, MWS, LWS
1.1.2	Differentiate the threat from the background	System computer or operator
1.1.3	Identify the type of threat and the tracking method used by the threat	System computer or operator
1.1.4	Measure the position of the threat	RWR, MWS, LWS, and system computer or operator
1.1.5	Identify the weakness of the threat	System computer or operator
1.2.0	Determine course-action	
1.2.1	Assess options	System computer or operator
1.2.2	Select a course of action	System computer or operator
1.3.0	Employ a counter-action	
1.3.1	Determine time to act	System computer or operator
1.3.2	Act to counter	An actor that can counter the threat by jamming, deceiving, killing the threat, etc. (e.g., chaff, RF jammer, RF deceiver, RF decoy, flare dispensing system, IR deceiver, IR jammer, laser countermeasure, anti-air missiles, anti-radiation missiles)
1.3.3	Determine the degree of action	System computer or operator
1.3.4	Determine the UA maneuver to adopt	System computer or operator
1.4.0	Logistic support	



<b>Function</b>		<b>Physical Components</b>
1.4.1	Update the threat library	Intelligence agency supports UAS
1.4.2	Maintain the combat survivability enhancement solution	Maintainers
1.4.3	Provide logistic support for the combat survivability enhancement solution	Logicians
1.0	To Counter Incoming Threat	
1.1.0	Detect and Identify incoming threat	
1.1.1	Provide coverage in direction that threat will likely come from	RWR, MWS, LWS
1.1.2	Differentiate threat from background	System computer or operator
1.1.3	Identify type of threat and tracking method used by threat	System computer or operator
1.1.4	Measure position of threat	RWR, MWS, LWS, and System computer or operator
1.1.5	Identify weakness of threat	System computer or operator
1.2.0	Determine course-action	
1.2.1	Assess options	System computer or operator
1.2.2	Select course of action	System computer or operator
1.3.0	Employ counter-action	
1.3.1	Determine time to act	System computer or operator
1.3.2	Act to counter	An actor that can counter the threat by jamming, deceiving, killing the threat, etc. E.g. Chaff, RF Jammer, RF Deceiver, RF Decoy, Flare dispensing system, IR Deceiver, IR Jammer, Laser Countermeasure, Anti-air missiles, Anti-radiation missile
1.3.3	Determine degree of action	System computer or operator
1.3.4	Determine UA maneuver to adopt	System computer or operator
1.4.0	Logistic Support	
1.4.1	Update threat library	Intelligence agency support UAS

<b>Function</b>		<b>Physical Components</b>
1.4.2	Maintain combat survivability enhancement solution	Maintainers
1.4.3	Provide logistic support for combat survivability enhancement solution	Logicians

## **5. Functional and Requirement Allocation**

All functions are mapped to physical components. Some functions are packaged together and mapped to the same component. For example, the system computer or operator will perform the functions of differentiating a threat from background, identifying the type of threat, determining the course of actions, and deciding when to act, how much to act, and the UA maneuver to adopt as part of the counter action.

From the above, it is found that to counter an incoming threat, a warning system, a computer and/or operator, an actor that can counter the threat (by jamming, deceiving, killing the threat, etc.), and support agents are needed. The enhancement solution shall consist of all these components. Requirements are then allocated to each of these components.

## **6. Evaluating and Selecting Combat Survivability Enhancement Solutions**

Three combat survivability enhancement solutions have been proposed. The first solution proposes the installation of an RWR system as the warning system and a pair of towed RF decoys as countermeasures. The RWR system consists of four RF receivers, a signal processor, and an integrated control unit that operates the decoys too. The total weight of the solution is 53 lbs. The solution is estimated to require about 0.5 kW of electrical power for only the RWR to operate and 0.8 kW when the decoys are deployed.

Solution 2 proposes the installation of an RWR system and a chaff dispenser. The RWR system is to detect RF threats while the chaff is to counter RF-guided missiles or mask the UA from the adversary's radars. The solution weighs about 55 lbs and requires about 0.6 kW of electrical power to operate.

Solution 3 proposes the installation of a MWS system and a chaff and flare dispenser. This solution is not limited to only RF threats, as the MWS is also capable of detecting IR-guided missiles. The total system weight is about 55 lbs and requires about 0.6 kW of electrical power to operate.

The three combat survivability enhancement solutions are evaluated for their effectiveness (in reducing loss rate), compatibility (effects on the payload), and their effects on UA performance (in terms of endurance), and availability.

*a. Effectiveness*

The UA loss rate is an indication of the effectiveness of solution in enhancing UA combat survivability. Modeling and simulation of possible operation scenarios allows one to measure the likely loss rate of the UA when installed with each different solution.

The simulations show that UA implementing solution 1 has a loss rate of 0.02 kills per 1,000 operation hours. The UA implementing solution 2 has a loss rate of 0.03 kills per 1,000 and the last configuration of UA has a kill rate of 0.01 kills per 1,000 hours. All solutions meet the requirement of reducing the loss rate to at least 0.03 kills per 1,000 operating hours. The result is used to rank the solutions according to their effective. The comparison matrix is shown in Figure 25. As can be seen, solution 3 ranked the highest in the effectiveness aspect, followed by solution 1 then 2.

	<b>Solution 1</b>	<b>Solution 2</b>	<b>Solution 3</b>	<b>Weights</b>
<b>Solution 1</b>		1	1/3	0.1867
<b>Solution 2</b>			1/5	0.1578
<b>Solution 3</b>				0.6555

Figure 25. AHP Comparison Using Effectiveness as the Ranking Criteria.

***b. Performance***

The UA endurance is used to measure the effect of the solutions on the performance of the UA. Analytical models were used to compute the maximum endurance of the UA based on the new fuel consumption (due to the weight increase by the combat survivability enhancement features) and amount of fuel the UA can now carry. Results show that the UA has maximum endurances of 17 hours, 16.5 hours and 16 hours when installed with solution 1, 2 and 3 respectively. These results are used to ranked the solutions in the comparison matrix in Figure 26.

	<b>Solution 1</b>	<b>Solution 2</b>	<b>Solution 3</b>	<b>Weights</b>
<b>Solution 1</b>		2	3	0.5247
<b>Solution 2</b>			3	0.3338
<b>Solution 3</b>				0.1416

Figure 26. AHP Comparison Using Performance as the Ranking Criteria.

***c. Compatibility***

It is important that any solution implemented is compatible with the payload. Based on technical studies, there is insufficient electrical power to operate the sensor payload while the towed decoy is deployed (solution 1). Depending on the criticality of the mission, the customer is willing to trade mission success for UA combat survivability. However, solution 1 is ranked the lowest in the compatibility aspect. Solution 2 and 3 have no compatibility issues with the payload and therefore are ranked equal. Figure 27 illustrates the comparison.

	<b>Solution 1</b>	<b>Solution 2</b>	<b>Solution 3</b>	<b>Weights</b>
<b>Solution 1</b>		1/5	1/5	0.0909
<b>Solution 2</b>			1	0.4545
<b>Solution 3</b>				0.4545

Figure 27. AHP Comparison Using Compatibility as the Ranking Criteria.

*d. Availability*

Availability is an indication of UAS being available for mission tasking when it is needed. It is required that inherent availability of UAS after implementing the solution should be at least 85%. Analysis shows that the UA will have an inherent availability of 93% when solution 1 is implemented, 90% when solution 2 is implemented and 95% when solution 3 is implemented. Figure 28 shows the ranking. As can be seen, solution 3, with the UA having the highest availability, is ranked the highest, followed by solution 1 then 2.

	<b>Solution 1</b>	<b>Solution 2</b>	<b>Solution 3</b>	<b>Weights</b>
<b>Solution 1</b>		3	1/3	0.2605
<b>Solution 2</b>			1/5	0.1062
<b>Solution 3</b>				0.6333

Figure 28. AHP Comparison Using Availability as the Ranking Criteria.

*e. “Best” Solution*

The evaluation result is summarized in Figure 29. As can be seen, solution 3 is determined to have the most benefits to UAS combat survivability, followed by solution 2 and then solution 1.

	<b>Weight</b>	<b>Solution 1</b>	<b>Solution 2</b>	<b>Solution 3</b>
<b>Loss Rate</b>	0.4314	0.1867	0.1578	0.6555
<b>Endurance</b>	0.1776	0.5247	0.3338	0.1416
<b>Compatibility</b>	0.2807	0.0909	0.4545	0.4545
<b>Availability</b>	0.1102	0.2605	0.1062	0.6333
<b>Overall</b>		<b>0.2280</b>	<b>0.2666</b>	<b>0.5053</b>

Figure 29. Overall Results

Cost analysis was performed on all solutions to estimate the total cost of operating and supporting the solutions for UAS lifecycle. All three solutions were deemed to be within the customer’s threshold.

The customer decides to select the most beneficial solution that is deemed affordable. Since all solutions are within the customer’s threshold, solution 3 is the “best” solution. UAS will therefore be installed with a MWS and chaff and flare dispensers to enhance its combat survivability.

## I. CHAPTER SUMMARY

A balance between the combat survivability of an existing UAS and meeting its other objectives must be met when enhancing its combat survivability. This chapter proposed a seven-step process to help decide whether it is necessary to enhance the combat survivability of an existing UAS and, if necessary, which combat survivability enhancement feature(s) to select. The process includes establishing the need to enhance combat survivability, performing a feasibility analysis of the top-level enhancement approaches, identifying objectives and defining requirements, performing a functional analysis of the enhancement approach, allocating functions and requirements to components, evaluating the proposed enhancement solutions, and selecting the “best” solution. An example was also created to illustrate the process.

THIS PAGE INTENTIONALLY LEFT BLANK

## VII. CONCLUSION

Unmanned Aircraft Systems traditionally were designed to be inexpensive and dispensable. Little consideration was given for their combat survivability. However, as war fighters' reliance on UAS grows the need for UAS to be survivable in hostile environments increases. There is a need to enhance the combat survivability of existing UAS.

A standard "one size fits all" solution to unmanned aircraft combat survivability is not available due to the wide range of sizes and performances of the UA. Smaller UAs, limited by size, weight carrying capability and power, unlikely are able to support combat survivability enhancements that will result in adding (much) more weight and/or require (much) more power from the UA. Combat survivability enhancement options are thus very limited for smaller UAs. The larger UAs, on the other hand, may have more options. There is a higher possibility that larger UAs can support active susceptibility reduction features and/or vulnerability reduction features. Potential combat survivability enhancement options includes increasing a UA's operating altitude, changing the UA's operating speed, installing warning systems and/or electronic countermeasures, improving payload performance, reducing the data link's probability of interception, increasing the data link's resistance to jamming, locating the ground elements outside the threat circle, and improving human factor issues in UAS.

The consequences of implementing combat survivability enhancement solutions to existing UAS, is complicated because UAS design is usually already optimized. There is little room available on UAS for the combat survivability engineer to add more or even swap equipment. Numerous trade-offs may be necessary between combat survivability and performance, logistic burden, etc. However, a balance must be maintained between making UAS more survivable and trading off the other UAS objectives. The performance and cost of UAS should not be traded for combat survivability so much so that the shortfalls outweigh the perceived value of the combat survivability. The



DarkStar mistake must not be allowed to repeat. A process must be put in place to help decide the necessity to enhance the combat survivability and to select the combat survivability enhancement solutions.

The process begins by establishing the need to enhance UAS combat survivability, followed by performing a feasibility analysis to select preferred approaches. Once the feasibility analysis is done, the next step is to identify customers' objectives and define the requirements. This is followed by a functional analysis to identify all the resources (or physical components) necessary for the system to enhance UAS combat survivability. The functions and lower-level requirements are then allocated to these resources. Once done, all alternative combat survivability enhancement solutions are then evaluated and the "best" solution is selected. Factors to consider when evaluating the alternatives include effectiveness of the solution in enhancing combat survivability, how UAS performance is affected, reliability, maintainability and supportability, how the solution affects system safety, the total cost of operating the solution, and finally, the time line required for the solution. By following the process, the combat survivability of an existing UAS can be enhanced.

## LIST OF REFERENCES

- [1] Laurence Newcome, "Aerial Torpedoes - Empty Cockpit Is Future of Flight", Defense News, 29 September 2003.
- [2] Andreas Parsch, "Curtiss/Sperry 'Flying Bomb'," downloaded 1 October 2008 from <http://www.designation-systems.net/dusrm/app4/sperry-fb.html>
- [3] Nick T. Spark, "The Battle Over America's Secret WWII Cruise Missile", downloaded on 21 November 2008 from <http://stagone.org/command-break.html>
- [4] Rear Admiral Robert H. Gormley, "UAS's and Combat Survivability", Aircraft Survivability Journal (Spring 2002), pp.7-9.
- [5] Nathan Broshear, "Air Force's Only UAV Wing Marks One Year In The Fight", Air Combat Command Newsletter, 7 May 2008.
- [6] Jim Young, "Tactical UAVs", Aircraft Survivability Journal (Fall 2002), pp. 9-10.
- [7] *Office of the Secretary of Defense Unmanned Systems Roadmap 2005-2030*, Office of the Secretary of Defense, 2005.
- [8] Dr. Daniel L. Haulman, "USAF Manned Aircraft Combat Losses 1990-2002", Air Force Historical Research Agency, 9 December 2002.
- [9] Air Force Link, "MQ-1 Predator Unmanned Aircraft System," Downloaded 15 October from <http://www.af.mil/factsheets/factsheet.asp?id=122>
- [10] Peter La Franchi, "US study recommends self-protection for UAVs", Flight International, 7 September 2004.
- [11] Gary O. Langford, private conversation at Naval Postgraduate School, 20 October 2008.
- [12] Christopher Adams, Notes for ME4751 (Combat Survivability Engineering), Naval Postgraduate School, 2008 (unpublished).
- [13] Robert E. Ball, *Fundamentals of Aircraft Combat Survivability & Design, Second Edition*, American Institute of Aeronautics and Astronautics, Inc. Virginia, 2003.
- [14] Paul G. Fahlstrom and Thomas J. Gleason, *Introduction to UAV Systems*, Second Edition, UAV Systems, Inc., MD, June 1998.
- [15] Robert Valdes, "How the Predator UAV Works" downloaded 12 October from <http://science.howstuffworks.com/predator.htm>.

- [16] "Skylark I Miniature Aerial Vehicle," *Defense Update – International Online Defense Magazine*, Year 2004, Issue 2, downloaded 1 October 2008 from <http://www.defense-update.com/products/s/skylark1-uav.htm>.
- [17] Brochure on EL/K-1861 GDT, Israel Aerospace Industries Ltd., downloaded 3 October 2008 from <http://www.iai.co.il/Default.aspx?docID=29454&FolderID=24407&lang=en&res=0&pos=0&bt1=1>.
- [18] Ann Patton, "ROVER adds extra set of eyes to sky", Air Force Link, 1 August 2006.
- [19] *Work Breakdown Structures For Defense Materiel Items, MIL-HDBK-881A*, Department of Defense, 30 July 2005.
- [20] *Office of the Secretary of Defense Unmanned Systems Roadmap 2007-2032*, Office of the Secretary of Defense, 2007.
- [21] Frank Colucci, "Air Force Refines Training Programs for UAV Operators", *National Defense*, Arlington: May 2004. vol. 88, iss. 606, p. 36.
- [22] "An Intelligence, Surveillance And Reconnaissance (ISR) Vision For The Canadian Forces", *Canadian Military Journal*, Vol 2, No. 4, Winter 2001-2002.
- [23] Gayle S. Putrich, "USAF Laying Out 4-Decade UAV Plan," *Defense News*, published 17 October 2008.
- [24] Tim Ripley, "UAVs over Kosovo - did the Earth move?", *Defense Systems Daily*, 1 December 1999.
- [25] John R. Murphy, Cpl USMC, "Countering RPVs – A New Threat," *Marine Corps Gazette*, October 1987.
- [26] Robert Harney, Notes for SE4112 (Combat Systems Engineering III), Naval Postgraduate School, 2008 (unpublished).
- [27] Joseph J. Beel, *Anti-UAV Defense Requirements For Ground Forces And Hypervelocity Rocket Lethality Models*, Master's thesis, Naval Postgraduate School, Monterey, California, 1992.
- [28] Dynetics, "Data Summary Report, Volume II – Sensor System Screening for The NOMAD Acquisition Sensor", TR-91-MOCOM-0069-167 (1991).
- [29] Agence France Presse, "Georgia claims downing of Russian drone", AFP, 23 September 2008.

- [30] Marvin Pokrant, *Desert Storm at Sea: What the Navy Really Did*, pp.20-22, Greenwood Publishing Group, 1999
- [31] William J. Perry, *Desert Storm And Deterrence*, Foreign Affairs, Fall 1999.
- [32] Kevin L. McMIndes, Unmanned Aerial Vehicle Survivability: The Impacts Of Speed, Detectability, Altitude, And Enemy Capabilities, Master's Thesis, Naval Postgraduate School, California, September 2005.
- [33] Johnny Heikell, "Electronic Warfare Self-Protection of Battlefield Helicopters: A Holistic View".
- [34] Goran Petterssin, "An Illustrated Overview of ESM and ECM Systems."
- [35] Brochure on LR-100, Northrop Grumman Corporation, downloaded 30 July 2008 from [www.es.northropgrumman.com/solutions/lr100ew/assets/LR100.pdf](http://www.es.northropgrumman.com/solutions/lr100ew/assets/LR100.pdf)
- [36] Stephen Trimble, "Helicopter Missile Warning Systems Poised For Next Major Leap", Flight International, 04 November 2008.
- [37] Goran S.E. Pettersson, *An Illustrated Overview of ESM and ECM Systems*, Master's thesis, Naval Postgraduate School, Monterey, California, 1993.
- [38] Doug Richardson, *An Illustrated Guide To The Techniques And Equipment Of Electronic Warfare*, Arco Publishing, Inc., New York, 1985.
- [39] Sifu Wang, Yongcai Liu, Shiyi Guan and Wenyi Qiang, "Research On Penetration Effectiveness Of UAV By Means Of Towed-Decoy", Proc. of *IMACS Multiconference on Computational Engineering in Systems Applications*, 4-6 October 2006, Volume 1, pp. 701-706, IEEE Press, 2006.
- [40] "Raytheon's ALE-50 "Little Buddy" Decoys", Defense Industry Daily, 22 October 2008.
- [41] Air Force Link, "RQ-4 Global Hawk Unmanned Aircraft System", downloaded on 23 October 2008 from <http://www.af.mil/factsheets/factsheet.asp?fsID=13225>
- [42] James Chow, James Chiesa, et al., "Protecting Commercial Aviation Against The Shoulder-Fired Missile Threat", RAND Corporation, 2005.
- [43] David L. Adamy, *EW 102: A Second Course in Electronic Warfare*, Artech House, London, 2004.
- [44] Jim Krane, "Pilotless Warriors Soar To Success", CBS News, 25 April 2005 downloaded on 22 October 2008 from <http://www.cbsnews.com/stories/2003/04/25/tech/main551126.shtml>

- [45] Michael Bass, *Handbook of Optics*, Volume III, 2<sup>nd</sup> edition, McGraw-Hill Professional, 1978.
- [46] Robert Wall, "Pentagon Declares Predator Combat Loss", *Aviation Week & Space Technology*, 3 September 2001, Vol. 155 Issue 10, p.77.
- [47] Robert Harney, Notes for SE3112 (Combat Systems Engineering I), Naval Postgraduate School, 2007 (unpublished).
- [48] Gerald L. Dillingham, et al., "Unmanned Aircraft Systems - Federal Actions Needed to Ensure Safety and Expand Their Potential Uses within the National Airspace System", GAO report, GAO-08-511, dated May 2008.
- [49] Scott Lindlaw, "Human error causes most Predator crashes", *The Associated Press*, 26 August 2008.
- [50] Scott Lindlaw, "Remote-Control Warriors Suffer War Stress Too", *The Associated Press*, 7 August 2008.
- [51] B. Blanchard and W. Fabrycky, *Systems Engineering And Analysis*, 4th ed. New Jersey: Prentice-Hall, 2006.
- [52] G. Roedler and C. Jones, "Technical Measurement," Technical Report No. TP-2003-020-01, INCOSE, 27 December 2005.
- [53] "RQ-4A/B Global Hawk High-Altitude, Long-Endurance, Unmanned Reconnaissance Aircraft, USA," from *airforce-technology.com*, downloaded on 31 July 2008 from <http://www.airforce-technology.com/projects/global/>
- [54] D. Nussbaum, "Cost Estimation," class notes for OA4702, Naval Postgraduate School, 2007.

## INITIAL DISTRIBUTION LIST

1. Defense Technical Information Center  
Ft. Belvoir, Virginia
2. Dudley Knox Library  
Naval Postgraduate School  
Monterey, California
3. Commander, Naval Air Systems Command,  
NAVAIR 4.1,  
Patuxent River, Maryland
4. Gary Langford  
Naval Postgraduate School  
Monterey, California