



**Calhoun: The NPS Institutional Archive**  
**DSpace Repository**

---

NPS Scholarship

Theses

---

2004-09

# The International Space Station comparative maintenance analysis model (CMAM)

Soldon, Brian T.

Monterey, CA; Naval Postgraduate School

---

<https://hdl.handle.net/10945/1344>

---

This publication is a work of the U.S. Government as defined in Title 17, United States Code, Section 101. Copyright protection is not available for this work in the United States.

*Downloaded from NPS Archive: Calhoun*



Calhoun is the Naval Postgraduate School's public access digital repository for research materials and institutional publications created by the NPS community. Calhoun is named for Professor of Mathematics Guy K. Calhoun, NPS's first appointed -- and published -- scholarly author.

**Dudley Knox Library / Naval Postgraduate School**  
**411 Dyer Road / 1 University Circle**  
**Monterey, California USA 93943**

<http://www.nps.edu/library>



**NAVAL  
POSTGRADUATE  
SCHOOL**

**MONTEREY, CALIFORNIA**

**THESIS**

**THE INTERNATIONAL SPACE STATION COMPARATIVE  
MAINTENANCE ANALYSIS MODEL (CMAM)**

by

Brian T. Soldon

September 2004

Thesis Advisor:  
Second Reader:

Chiold Epp  
Daniel Bursch

**Approved for public release; distribution is unlimited**

THIS PAGE INTENTIONALLY LEFT BLANK

REPORT DOCUMENTATION PAGE			Form Approved OMB No. 0704-0188	
Public reporting burden for this collection of information is estimated to average 1 hour per response, including the time for reviewing instruction, searching existing data sources, gathering and maintaining the data needed, and completing and reviewing the collection of information. Send comments regarding this burden estimate or any other aspect of this collection of information, including suggestions for reducing this burden, to Washington headquarters Services, Directorate for Information Operations and Reports, 1215 Jefferson Davis Highway, Suite 1204, Arlington, VA 22202-4302, and to the Office of Management and Budget, Paperwork Reduction Project (0704-0188) Washington DC 20503.				
1. AGENCY USE ONLY (Leave blank)		2. REPORT DATE September 2004	3. REPORT TYPE AND DATES COVERED Master's Thesis	
4. TITLE AND SUBTITLE: The International Space Station Comparative Maintenance Analysis Model (CMAM)			5. FUNDING NUMBERS	
6. AUTHOR(S): MAJ Brian T. Soldon			8. PERFORMING ORGANIZATION REPORT NUMBER	
7. PERFORMING ORGANIZATION NAME(S) AND ADDRESS(ES) Naval Postgraduate School Monterey, CA 93943-5000			10. SPONSORING/MONITORING AGENCY REPORT NUMBER	
9. SPONSORING /MONITORING AGENCY NAME(S) AND ADDRESS(ES) N/A			11. SUPPLEMENTARY NOTES The views expressed in this thesis are those of the author and do not reflect the official policy or position of the Department of Defense or the U.S. Government.	
12a. DISTRIBUTION / AVAILABILITY STATEMENT Approved for public release; distribution is unlimited			12b. DISTRIBUTION CODE A	
13. ABSTRACT (maximum 200 words) <p>The following thesis describes the current model (the Reliability and Maintainability Assessment Tool – RMAT) used by NASA and related prime contractors for the forecasting of Orbital Replacement Unit (ORU) failure rates and associated maintenance demands for the International Space Station (ISS). A new model (the Comparative Maintenance Analysis Tool – CMAM) is introduced and developed for replicating some of the basic functionality of RMAT in order to provide a comparative look at RMAT results. The CMAM program, developed in Visual Basic.net and dynamically linked to a Microsoft ACCESS database, focuses on a representative set of critical Orbital Replacement Units (ORUs that represent key items that require both internal and external maintenance in both pressurized and un- pressurized storage) and generated failure rate data for each critical ORU. The results of the CMAM model are then compared with the failure rates generated by RMAT program for the same set of critical ORUs. These two independently developed sets of data are then analyzed against historic failure rates for these ISS parts.</p> <p>The results of this analysis are used to conduct a sensitivity analysis of both the CMAM and RMAT programs in order to help identify the primary contributing factors behind divergence issues between forecasted / predicted failures and associated maintenance from actual (historical) failure rates.</p> <p>Recommendations are provided, based upon the results of the comparison, with respect to the sensitivity of RMAT to changes in certain input parameters, as well as on the feasibility of implementing CMAM as a comparative tool for use by both NASA and Boeing L&amp;M personnel for the purpose of RMAT sensitivity analysis, as well as use in initial operational planning for optimizing ORU stocking levels while awaiting more comprehensive RMAT results.</p>				
14. SUBJECT TERMS: ISS, CMAM, RMAT, ORU, NASA, JSC, LSAR, IVA, EVA, EVR, CM, PM, FORTRAN, VB.NET, EXCEL, ACCESS, EXCEL, Crystal Ball, GUI, MTBF, MTTR, MTBMA			15. NUMBER OF PAGES 77	
			16. PRICE CODE	
17. SECURITY CLASSIFICATION OF REPORT Unclassified	18. SECURITY CLASSIFICATION OF THIS PAGE Unclassified	19. SECURITY CLASSIFICATION OF ABSTRACT Unclassified	20. LIMITATION OF ABSTRACT UL	

THIS PAGE INTENTIONALLY LEFT BLANK

**Approved for public release; distribution is unlimited**

**THE INTERNATIONAL SPACE STATION COMPARATIVE MAINTENANCE  
ANALYSIS MODEL (CMAM)**

Brian T. Soldon  
Major, United States Army  
B.S., United States Military Academy, 1993

Submitted in partial fulfillment of the  
requirements for the degree of

**MASTER OF SCIENCE IN SPACE SYSTEMS OPERATIONS**

from the

**NAVAL POSTGRADUATE SCHOOL  
September 2004**

Author: Brian T. Soldon

Approved by: Chiold Epp  
Thesis Advisor

Daniel Bursch  
Second Reader

Rudy Panholzer  
Chairman, Space Systems Academic Group

THIS PAGE INTENTIONALLY LEFT BLANK

## **ABSTRACT**

The National Aeronautic and Space Administration (NASA) and its prime contractors currently use a software tool called RMAAT (the Reliability and Maintainability Assessment Tool) for the forecasting of Orbital Replacement Unit (ORU) failure rates and associated maintenance demands for the International Space Station (ISS). This thesis introduces a new model: CMAM (the Comparative Maintenance Analysis Tool), which was developed to replicate some of the basic functionality of RMAAT in order to provide a comparative look at RMAAT results. The CMAM program, developed in Visual Basic.net and dynamically linked to a Microsoft ACCESS database, focuses on a representative set of critical Orbital Replacement Units (ORUs that represent key items that require both internal and external maintenance in both pressurized and un-pressurized storage) and generated failure rate data for each critical ORU. The results of the CMAM model are then compared with the failure rates generated by RMAAT program for the same set of critical ORUs. These two independently developed sets of data are then analyzed against historic failure rates for these ISS parts.

The results of this analysis are used to conduct a sensitivity analysis of both the CMAM and RMAAT programs in order to help identify the primary contributing factors behind divergence issues between forecasted failures and associated maintenance from actual (historical) failure rates.

Recommendations are provided, based upon the results of the comparison, with respect to the sensitivity of RMAAT to changes in certain input parameters, as well as on the feasibility of implementing CMAM as a comparative tool for use by both NASA and Boeing Logistics and Maintenance (L&M) personnel for the purpose of RMAAT sensitivity analysis, as well as use in initial operational planning for optimizing ORU stocking levels while awaiting more comprehensive RMAAT results.



THIS PAGE INTENTIONALLY LEFT BLANK

# TABLE OF CONTENTS

<b>I.</b>	<b>INTRODUCTION.....</b>	<b>1</b>
	A. <b>PURPOSE.....</b>	<b>1</b>
	B. <b>LOGISTICS AND MAINTENANCE OF THE ISS.....</b>	<b>2</b>
	C. <b>LOGISTICS SUPPORTABILITY ASSESSMENT.....</b>	<b>3</b>
	D. <b>PREDICTIVE ANALYSIS USING RMAT.....</b>	<b>6</b>
	E. <b>OVERALL RESULTS FROM RMAT.....</b>	<b>8</b>
<b>II.</b>	<b>CMAM DEVELOPMENT.....</b>	<b>11</b>
	A. <b>OVERVIEW.....</b>	<b>11</b>
	B. <b>CMAM.....</b>	<b>12</b>
	1. <b>Basic Functionality.....</b>	<b>12</b>
	2. <b>Database Connectivity.....</b>	<b>15</b>
	3. <b>CMAM Distributions.....</b>	<b>16</b>
	a. <i>Overview.....</i>	<i>16</i>
	b. <i>The Exponential Distribution.....</i>	<i>16</i>
	c. <i>The Weibull Distribution.....</i>	<i>17</i>
	4. <b>CMAM Algorithms.....</b>	<b>21</b>
	a. <i>The Rutherford Equation.....</i>	<i>21</i>
	b. <i>The Gamma Function.....</i>	<i>23</i>
	5. <b>CMAM Output.....</b>	<b>24</b>
<b>III.</b>	<b>RMAT SENSITIVITY ANALYSIS.....</b>	<b>27</b>
	A. <b>RMAT VERSUS CMAM OUTPUT COMPARISON.....</b>	<b>27</b>
	B. <b>CMAM UNCERTAINTY USING CRYSTAL BALL.....</b>	<b>34</b>
	1. <b>Purpose of Crystal Ball Simulation Package.....</b>	<b>35</b>
	2. <b>Assumptions.....</b>	<b>35</b>
	3. <b>Crystal Ball Results.....</b>	<b>36</b>
<b>IV.</b>	<b>RECOMMENDATIONS AND CONCLUSIONS.....</b>	<b>39</b>
	A. <b>RECOMMENDATION FOR CMAM USE.....</b>	<b>39</b>
	B. <b>RECOMMENDATION FOR FOLLOW-ON RESEARCH.....</b>	<b>40</b>
	C. <b>CONCLUSION.....</b>	<b>40</b>
<b>APPENDIX A. CMAM DATABASE.....</b>		<b>43</b>
	A. <b>INTRODUCTION.....</b>	<b>43</b>
	B. <b>ASSUMPTIONS AND REQUIREMENTS.....</b>	<b>43</b>
	Stakeholders.....	43
	Query Requirements.....	43
	C. <b>RELATIONS, RELATIONSHIPS, AND CONSTRAINTS.....</b>	<b>43</b>
	Entity Relationship Diagram (ERD).....	44
	Table/Column Diagram.....	44
	Microsoft Access Relationships.....	44
	D. <b>USER INTERFACE.....</b>	<b>47</b>
<b>APPENDIX B. LIST OF ABBREVIATIONS AND ACRONYMS.....</b>		<b>49</b>

<b>LIST OF REFERENCES.....</b>	<b>53</b>
<b>BIBLIOGRAPHY .....</b>	<b>55</b>
<b>INITIAL DISTRIBUTION LIST .....</b>	<b>57</b>

## LIST OF FIGURES

Figure 1.	ORU life-cycle failures versus time (from: Beardmore).....	8
Figure 2.	CMAM Functionality Diagram.....	12
Figure 3.	RMAT Functionality Diagram (from: The Boeing Company).....	14
Figure 4.	Exponential Distribution Equations (from: Walpole).....	17
Figure 5.	Weibull Distribution Equations (from: Walpole) .....	18
Figure 6.	Weibull Distribution Example, Beta = 1 .....	19
Figure 7.	Weibull Distribution Example, Beta = 5 .....	20
Figure 8.	Rutherford Equations (from: McDonnell Douglas Space Systems) ....	22
Figure 9.	Gamma Function (from: Walpole).....	23
Figure 10.	Stirling's Asymptotic Series (from: Beyer) .....	23
Figure 11.	CMAM Output screen .....	25
Figure 12.	RMAT CMG Maintenance Action forecasts w/ and w/o PM.....	33
Figure 13.	CMAM Steady State Output Results .....	36
Figure 14.	Crystal Ball ®_ Output results .....	37
Figure 15.	CMAM ORU Database ERD.....	45
Figure 16.	CMAM ORU Database Table/Column Diagram .....	46
Figure 17.	CMAM ORU Microsoft Access Relationship.....	46
Figure 18.	CMAM ORULIST Table User Interface.....	47
Figure 19.	CMAM FLIGHT Table User Interface .....	48

THIS PAGE INTENTIONALLY LEFT BLANK

## LIST OF TABLES

Table 1.	RMAT Input parameters .....	27
Table 2.	RMAT Maintenance Action output results .....	28
Table 3.	CMAM Maintenance Action Output results.....	30
Table 4.	CMAM CMG Maintenance Action forecasts w/ and w/o PM.....	31

THIS PAGE INTENTIONALLY LEFT BLANK

## **ACKNOWLEDGMENTS**

I would like to thank the following individuals for their assistance in the research and development of this thesis. Their professionalism and expertise were critical in the areas of understanding both NASA and Boeing Logistics and Maintenance (L&M) tasks in reference to the International Space Station, and in the understanding of how reliability tools are used in relation to ISS L&M planning and management:

Mr. Anthony J. Butina Sr. (NASA ISS Logistics and Maintenance,  
Houston, TX)

Mr. Paul A. Rathbun (NASA ISS Logistics and Maintenance, Houston, TX)

Mr. Jesse Astorga (Boeing ISS Logistics and Maintenance, Houston, TX)



THIS PAGE INTENTIONALLY LEFT BLANK

## EXECUTIVE SUMMARY

The logistics and maintenance of the International Space Station (ISS) is a one of a kind system with over 5700 orbital replacement units (ORUs)<sup>1</sup>, and spare parts that number into the hundreds of thousands. Parts for the ISS come from 127 major US vendors and 70 major international vendors. It is the responsibility of the International Space Station Logistics and Maintenance (L&M) organization at Johnson Space Center in Houston Texas to integrate and test these spares before either delivery to the ISS or ground spare storage.

The objective of the ISS L&M organization is to define, procure, deliver, and manage the resources required to support and maintain ISS systems and support equipment both on-orbit and on the ground during assembly and assembly complete operations of the ISS. In order to meet this objective NASA ISS L&M must maintain a comprehensive ORU and spares database with up to date reliability data for use in predicting and evaluating on-orbit, and ground spares requirements.

The primary tool used for this purpose is the Reliability and Maintainability Assessment Tool (RMAT). RMAT is a simulation tool that generates ORU failures, quantifies corrective and preventative maintenance requirements, and quantifies ISS resources needed to restore the ISS to an operational state. RMAT is the ISS Program/GAO accepted<sup>2</sup> tool for conducting maintenance prediction analysis and trade studies, and, when used in concert with an accurate and updated ORU database, as well as with other tools such as Steady State<sup>3</sup> spreadsheets, provides a robust set of forecast data. However, RMAT is a

---

<sup>1</sup> Although the total number of ORUs is estimated at 5700 the ORU database (MADS) lists 1379 unique ORU types available for reliability analysis.

<sup>2</sup> The U.S. General Accounting Office (GAO) is the investigative arm of Congress whose mission is to execute audits, surveys, investigations and evaluations of Government programs to support oversight and funding decisions

<sup>3</sup> ISS Steady State is defined as after Assembly Complete (AC) operations

complex program written in an obsolete programming language (FORTRAN77) that requires a high degree of user familiarity in order to produce meaningful results, and to summarize those results for decision-making purposes. RMAT requires the preparation of multiple text-based input files that can be and often is, extremely time consuming. Additionally, while recent analysis of actual versus predicted internal ORU failures shows a reasonable amount of correlation, external ORU failures show an increasing divergence between RMAT forecasted failures and actual failures.

The ISS Comparative Maintenance Analysis Model (CMAM) was developed to replicate some of the basic functionality of RMAT in the areas of Corrective and Preventative ORU failure rate forecasts and required crew maintenance time requirements in order to:

- Gain an understanding of the underlying algorithms used by RMAT for failure rate generation

- Provide a user friendly Graphical User Interface (GUI) based program that allows for the generation of a basic set of comparative results against the more complex and comprehensive RMAT forecasts

- Conduct a sensitivity analysis on both CMAM and RMAT results in order to identify why divergence issues have arisen between external failure rates and actual failure rates while internal failure rate forecasts remain relatively accurate.

The CMAM program developed during this thesis study is a Visual Basic.Net (VB.net) based program that allows for the concurrent editing of an Access based ORU database, the querying of the ORU database for analysis of specific sets of ORUs, and the subsequent generation of corrective maintenance (CM) and preventative maintenance (PM) failure rate data for that set of ORUs.

To analyze the inherent uncertainties of CMAM results, a representative set of ORUs was chosen from the comprehensive ORU database (MADS)<sup>4</sup>. The

---

<sup>4</sup> MADS or the Modeling Analysis Data Set is the comprehensive ORU data set with associated ORU reliability data. It is the primary responsibility of NASA R&M to update MADS and it is used extensively by NASA and Boeing L&M teams for reliability analysis.

representative set of ORUs consists of 60 internal, and 60 external ORUs with the highest criticality code (C1)<sup>5</sup>, and heaviest by weight to orbit<sup>6</sup>. This set of ORUs was assumed to have the same generic failure distribution characteristics as the entire set of ISS ORUs.

Comparison of CMAM and RMAT results in terms of these 120 ORUs shows a 7.5% discrepancy in failure rates when looked at over the life of the ISS. Additionally, external ORU failure rate predictions of the two programs are within 2%, internal failure rate forecasts show an approximate 8% difference (CMAM and RMAT show a relatively close correlation when overall failure rates are compared.

The CMAM program is most sensitive to changes in Preventative Maintenance timeframes for short MTBF (Mean Time Between Failure)<sup>7</sup> ORUs when wear-out failures are modeled. Since failure rates for wear-out failures using a Weibull distribution increase exponentially towards the end of life of an ORU it is imperative to conduct preventative maintenance of these parts in a timely manner. If short MTBF ORUs are allowed to operate until failure (w/o preventative maintenance) these parts will produce very high failure rates in the forecast model. Analysis of the 120 ORUs within the CMAM database reveals that the majority of planned PM is for internal ORUs while external parts are more often allowed to operate past predicted failure (based upon criticality of component). Since RMAT uses a similar Weibull distribution algorithm and similar shape factors<sup>8</sup>, and if the critical ORU list used for CMAM results is considered to be “representative” of the entire ORU list used by RMAT – then it can be assumed that RMAT is also sensitive to Preventative maintenance

---

<sup>5</sup> Criticality Code 1 (C1) is defined as a single point failure that could result in loss of Space Station or loss of flight or ground personnel.

<sup>6</sup> Weight to orbit was an arbitrary choice for ORU set analysis, and was made early in this research due to ORU/spare up-mass to the ISS being such a critical factor at this time.

<sup>7</sup> MTBF for this thesis is defined as the average time (in hours) that a component works without failure.

<sup>8</sup> The Weibull distribution often used to model wear-out failures of components has three parameters: location, size and shape.

scheduling, especially for external ORUs. This sensitivity, along with inherent uncertainty of ORU MTBF values may be enough to explain the divergence issues between external failure rates and actual failures. The results of this sensitivity analysis are discussed in detail within this thesis.

CMAM could potentially be used in concert with RMAT to provide a “first cut” forecast of ISS ORU failures and crew requirements to give L&M planners a general idea of what failures they can expect while waiting for the comprehensive RMAT results. CMAM results can also be used as a sensitivity check of RMAT for random, and wear-out failure modes for predictions of required corrective and preventative maintenance actions. These comparative results could lead to the rapid determination (and the corresponding correction) of future divergence issues between RMAT results and historical (actual) ORU failure rates.

# I. INTRODUCTION

## A. PURPOSE

Assembly of the International Space Station (ISS) began in November 1998 and will continue until completion sometime around 2010. During assembly and over the ISS's nominal 10 year lifetime it will serve as an orbital platform for the United States and International Partners to make advances in microgravity, space life, and earth sciences, as well as engineering research and technology development. The utilization of the ISS for creating knowledge and technology is an enterprise that not only requires the initial construction of a safe and viable orbiting laboratory, but also requires the maintenance of this one-of-a-kind system on a continuous basis in order to optimize the functional availability of systems required for both experimentation, and crew life support.

The ISS Logistics and Maintenance (L&M) Organization has the following philosophy:

The ISS does not have any landing gear, is not a satellite exploring the solar system, it has no International borders, and it has no organizational lines. It is one Station, that must be supported by ONE crew, twenty-four hours a day, seven days a week, three-hundred and sixty-five days a year.<sup>9</sup>

With this in mind the NASA and Boeing L&M teams rely upon developed, tested, and proven modeling programs in order to forecast Orbital Replacement Unit (ORU) failure data and associated maintenance requirements for use in operational planning and to determine if the ISS is logistically supportable in current and future configurations. The primary tool for ORU predictive analysis is the RMAAT program.

This thesis report describes the RMAAT program used by NASA and Boeing L&M, and introduces a new predictive tool (CMAM), developed as part of this research, which replicates some of the basic functions of RMAAT. The objective is to gain a better understanding of the RMAAT program, and to develop

---

<sup>9</sup> NASA Logistics and Maintenance Overview Briefing, March 8, 2004

a user friendly tool for conducting quick ORU failure analysis and sensitivity analysis of various failure parameters. These results can be used to determine what may be the root cause of divergence issues discovered between RMAT results and historical failures for external ISS ORUs.

## **B. LOGISTICS AND MAINTENANCE OF THE ISS**

The ISS has over 5700 orbital replacement units (ORUs), and spare parts that number into the hundreds of thousands. Parts for the ISS come from 127 major US vendors and 70 major international vendors and in most cases require the shipment of these parts from the prime vendor (often called the Original Equipment Manufacturer or OEM) location to Johnson Space Center (JSC) in Houston, TX for testing, and then to Kennedy Space Center (KSC), FL for follow on delivery to the ISS.

The objective of the ISS L&M organization is to define, procure, deliver, and manage the resources required to support and maintain ISS systems and support equipment both on-orbit and on the ground. The mission statement of the L&M team is two-part:

Part I: During Design and Development Phase to define necessary supportability requirements and to ensure they are planned for and met in order to economically, time effectively, and safely support successful operations.

Part II: During Operations Phase to manage logistics resources and conduct maintenance operations that ensure that the on-orbit vehicle and its associated systems support safe, successful operations and utilization.

The On-Orbit Ops and Maintenance Re-supply section within the NASA L&M organization is responsible for continuous monitoring of up-mass and crew time required for maintenance and on-orbit stowage of spares both inside and outside of the Station. This section uses a specific tool (called the Reliability Maintainability Analysis Tool or RMAT) to help predict and evaluate all on-orbit maintenance. ISS L&M management found that initial outputs of the RMAT predictive model during the assembly phase (specifically from flights 2A through 12A) show that these flights, and the continued ISS operations and assembly

have limited failure tolerance and redundancy especially in the power and thermal systems areas. The main goal of the On-Orbit Maintenance Re-supply team is not simply to buy more spares but to maximize/optimize the ability to re-supply spares quickly when needed and to store the most critical ORUs onboard in the proper quantity during the assembly stages.

The ISS Program office has the overall responsibility for oversight of the three main ISS contractors: Boeing, the United Space Alliance (USA), and the Blackhawk Corporation. Boeing Logistics and Maintenance, headquartered in Houston, TX is responsible for the production of the On-Orbit Logistics and Supportability Assessment Report (LSAR). The On-Orbit LSAR is a bi-annual report that uses historical data, and predictive analysis (primarily through the use of RMAT) to make assessments of the ongoing logistic supportability of the ISS.

### **C. LOGISTICS SUPPORTABILITY ASSESSMENT**

The overall goal of the ISS L&M system is to support the Station within the programs limited resources, to provide a safe and habitable environment for the crew, and to minimize ISS system downtime (downtime that impacts the function of the ISS as a research facility). To accomplish this goal the L&M personnel provide periodic assessments to determine the resource requirements needed to logistically support the ISS as designed and built. These requirements are summarized in the On-Orbit Logistics Supportability Assessment Report (LSAR). The resources for maintenance of the ISS taken into account within the LSAR include:<sup>10</sup>

- Spares and spare parts (ORUs, and other spares)
- Launch locations for storage of spares
- Tools for performing required maintenance
- Extra-Vehicular Activity (EVA)
- Extra-Vehicular Robotic capability (EVR)
- Transportation assets for transport of supplies to the ISS

In order to understand the LSAR it is important to understand the two basic ISS maintenance types, and the ISS 3-Level Maintenance Concept.

---

<sup>10</sup> This list only covers major resource items and is not all -inclusive.



Maintenance for the ISS will be either Corrective Maintenance (CM), or Preventative Maintenance (PM). Corrective Maintenance is maintenance performed to repair or replace ORUs/spare parts that fail while in service. Preventative maintenance is maintenance performed to replace ORUs/spare parts that have a specified operational life (in accordance with reliability data), and have not failed yet but have reached the end of their operational effective life.

Within the ISS 3-Level Maintenance Concept there are three levels of maintenance: Organizational, Intermediate, and Depot maintenance.

Organizational Maintenance is either corrective maintenance by on-orbit replaceable unit removal and replacement, or in situ repair, or preventative through scheduled change out of items, service or inspection in order to maintain system function in an operational condition and to prevent degradation of ISS performance. Organizational repair can occur either on-orbit or on the ground.

Intermediate Maintenance is corrective maintenance only to repair ORUs by disassembly, repair and reassembly, and is in response to real-time requirements for a work-around solution. This type of maintenance is on-orbit and internal to the ISS only.

Depot maintenance is corrective maintenance to repair/overhaul a designated hardware item that cannot be accomplished at the other maintenance levels (this requires broken ORUs/spare parts to be returned to earth and fixed at either one of the 4 NASA depots, or back at the OEM facility).

Thus it can be stated that there are only two levels of on-orbit maintenance – Organizational which consists of removal and replacement of ORUs, in situ repair, servicing and manual fault isolation, and is conducted either within the ISS (IVA), thru external spacewalk (EVA), or through external robotics (EVR), and Intermediate which consists of removal and replacement of ORUs at a maintenance work area through the application of authorized repair kits, and is conducted IVA only.

The major logistics resources available to support the ISS include: ORUs/ spare parts, locations for storage of spares, tools for performing required maintenance, Intra-Vehicular Activity (IVA), Extra-Vehicular Activity (EVA), Extra-Vehicular Robotic capability (EVR), and transportation assets for transport of supplies to the ISS.

It is important to note that, for the purposes of the ISS On-Orbit LSAR and predictive analysis, the ISS post assembly complete re-supply/logistics support is still based upon four (4) shuttle flights per year (3 defined as mixed mission (pressurized/un-pressurized), and 1 completely un-pressurized). These four flights are also planned for the assembly phase. The assembly phase requires a large amount of new hardware (for assembly of the ISS) and thus much less capability for ORUs/spares upmass. Therefore, it is expected that a supply backlog will build up during the later stages of the assembly phase, and will take some time to work-off upon Assembly Complete. This backlog consists of maintenance and repair actions needed to restore the optimal functionality and redundancy of ISS systems (to date the backlogs have consisted primarily of non-critical ORUs since ISS on-orbit maintenance is scheduled based upon the priority (criticality) of the task). ORU backlog is another critical element in the predictive analysis process.

The overall goal of the L&M effort is to maximize the availability of key functions of the ISS while maintaining a safe environment for the crew. Boeing L&M and NASA utilize a tool called the Station Availability Reporting Tool (START) to provide a snapshot, and running cumulative tally (monthly) of Station hardware and functional availability. The 10 key functions looked at for this availability report include:

- Provide usage power
- Provide CO2 removal
- Provide Intra-module Temperature and Humidity Control (THC)
- Provide Internal Thermal Control System (ITCS) Heat Transfer
- Provide Command & Telemetry (uplink/downlink)
- Provide Robotics capability

- Provide Payload Data Downlink
- Provide Command and control
- Provide Extra-Vehicular Activity (EVA) capability
- Provide Fire Detection/ Suppression

These functions are reported in four separate ways:

- Predicted availability (shows a prediction of CURRENT availability of the function based on current sparing levels)
- Performance since activation of the function (measured)
- Performance for the last 6 months (measured)
- Availability Objective (estimated goals primarily for the performance since activation)

The supportability assessment addresses any shortcomings listed on the functional availability reports, and also assesses whether future functional objectives will be attainable, based primarily on predictive analysis. The primary predictive analysis tool used in developing the LSAR is the Loral Reliability and Maintainability Assessment Tool (RMAT).

#### **D. PREDICTIVE ANALYSIS USING RMAT**

The Reliability and Maintenance Assessment Tool (RMAT) is a Monte Carlo Based simulation tool used to project maintenance demands, including maintenance performed and resultant backlog. The main constraints of the RMAT program for simulation include (but are not limited to):

- Available spares
- Robotic capability
- Available weight/volume to orbit (primarily during assembly stage)

RMAT also has a number of input parameters that need to be entered in order to make predictions. There are 19 parameters that can be altered to affect predictions. However, the primary parameters include:

- Mean Time Between Failures (MTBF) –to predict # of corrective actions needed per ORU
- Mean Time To Repair (MTTR) to predict # of crew hours needed (both CM/PM actions)
- Life Limit of ORU
- Number of crew members required to perform maintenance task

- Quantities (of spares on orbit)
- Reliability class (criticality)
- Duty cycle
- Frequency of Preventative Maintenance

RMAT takes these constraints and input parameters and utilizes Monte Carlo processes/mathematical algorithms to predict ORU failures, predict corrective/preventative maintenance requirements, predict size and impact of maintenance backlog, and predict ISS resources needed to keep the ISS in an operational state.

RMAT uses iterative Monte Carlo simulation (primarily to account for inherent uncertainties within ORU predicted MTBF and K-factor<sup>11</sup> values), and mathematical algorithms (primarily for failure distribution calculations) for maintenance demand forecasting. An RMAT run consists of 600 iterations of a specific set of constraints/input parameters placed into the simulation model for a specific timeframe. The maintenance demand/result is an average of the iterations. RMAT generates failures of three basic types:

- Infant Mortality failures: failures that occur at a higher rate early in the lifetime of the hardware.
- Random failures: failures that occur randomly throughout the life of the ISS.
- Wear-out/life limited failures: Failures occurring at a higher rate as they approach end of life.

RMAT uses the following distributions when modeling these three types of failures:

- Exponential distribution: Random Failures
- Weibull distribution: Infant Mortality and Wear-Out failures

These three failure types and their respective distributions leads to an overall ORU life cycle curve that resembles what is called the “bathtub” curve:

---

<sup>11</sup> K-factor is a multiplier that accounts for increased equipment maintenance actions not included in the inherent MTBF estimates. See section III.C for further details.

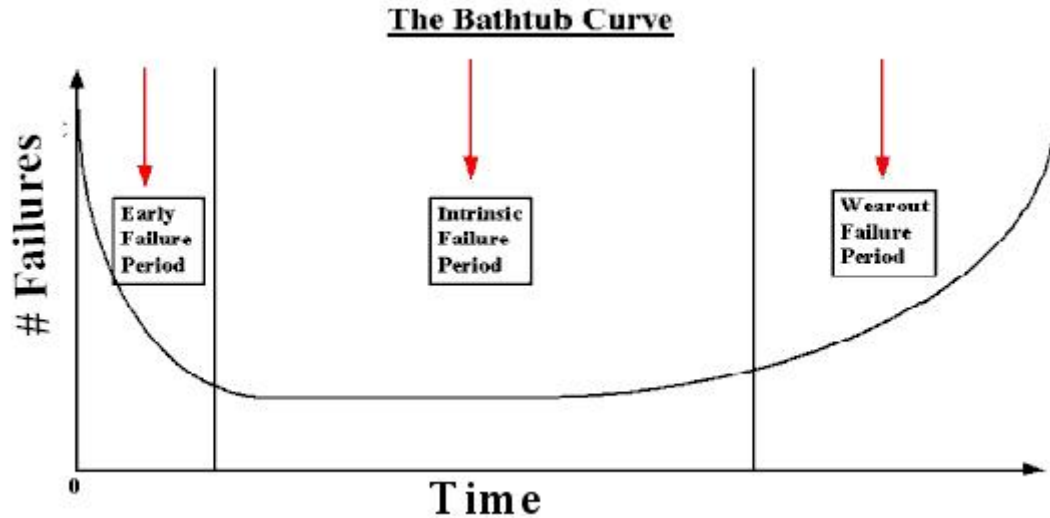

Figure 1. ORU life-cycle failures versus time (from: Beardmore)

There are four primary outputs of the RMAT program:

- Predicted maintenance actions required by flight (these maintenance actions are EVA/IVA/EVR actions required in response to a failure or a scheduled preventative maintenance remove and replace (PMRR), or from required servicing/inspection activity)
- Maintenance Action Backlog (the backlog is made up of ORUs awaiting maintenance action due to a shortfall in resources (on-orbit spares/ Shuttle up-mass/shuttle flights),
- Predicted crew time for maintenance actions by flight. (This includes EVA/IVA/EVR man-hours consumed to conduct maintenance activities)
- Predicted Up-Mass requirements by flight (this includes total ORU spares weight that will be launched to conduct corrective or scheduled maintenance).

#### **E. OVERALL RESULTS FROM RMAT**

Simulation results for the internal maintenance (IVA) of the ISS show adequate support both during and post assembly. RMAT results show a slightly negative margin between the number of maintenance actions required and the number of maintenance actions that will be performed leading to a minimal backlog buildup for IVA maintenance actions during the assembly stage. Since RMAT conducts maintenance based on ORU priority, none of the ORU items within the backlog are high criticality (C1) items. RMAT also shows a highly

positive margin upon assembly complete leading to the rapid work-off of this backlog. This positive margin during post-assembly is due to the fact that more up-mass and crew time can be allocated for spares and maintenance (as opposed to assembly).

External maintenance (EVA/EVR) does not seem to be as well supported. RMA results show negative margins between maintenance required and maintenance performed both during assembly and post assembly complete. This will lead to a continual increase in EVA/EVR maintenance action backlog. Specifically, RMA predicts that the ISS will require an average of 70 external maintenance actions per year during post assembly stage. Of these 70 an average of 31.5 will be performed (based on available up-mass and EVA/EVR crew times).

While RMA seems to be predicting internal maintenance actions relatively accurately, there is a growing divergence between RMA external maintenance predictions and actual/historical failures gathered to date. When comparing RMA predicted results to historical actuals (for both IVA and EVA respectively) the following results were seen:

IVA: Cumulative IVA forecasted Corrective Maintenance (CM) crew times exceeded actuals by 3%, while actual Preventative Maintenance (PM) crew times exceed forecasts by approximately 11%. Total CM / PM actions turned out to be within 15% of reported actuals.

EVA: Cumulative EVA forecasted CM crew times exceeded actuals by over 95%, while forecasted PM crew times exceeded actuals by 100% (no actual PM external activities were recorded). Average CM/PM EVA actions per year were forecasted to be nearly 44 and 12 respectively, while only 5 EVA CM actions were performed in total.

NASA and Boeing L&M are currently examining these divergence issues by reviewing reliability data and RMA model input fields in order to determine the most sensitive aspects of the model itself and to estimate the effects of variance resulting from inconsistencies between model and on-orbit maintenance

assumptions. This thesis attempts to assist in this activity by developing an independent reliability model that replicates some of the basic functionality of RMAT and can be used comparatively to determine what input parameters have the greatest effect on model outputs.

## II. CMAM DEVELOPMENT

### A. OVERVIEW

The ISS Comparative Maintenance Model (CMAM) is a Visual Basic.Net ® program which calculates both corrective maintenance (CM) and preventative maintenance (PM) action requirements for ISS Orbital Replacement Units (ORUs) and associated crew maintenance time requirements (IVA/EVA/ EVR)<sup>12</sup>. CMAM was developed in order to replicate some of the functionality of RMAT in order to gain a better understanding of the algorithms used by RMAT, and to provide a basis for assessing the sensitivity of the two programs to changes in similar input parameters. Additionally, CMAM is meant as a user-friendly option to the much more complex RMAT program for the understanding of general ORU failure rate data. The process followed for CMAM development required the development of a separate ORU database constructed in Microsoft Access ® (see Appendix A) which was populated with a representative set<sup>13</sup> of ORUs from the entire NASA/BOEING L&M ORU Modeling Analysis Data Set (MADS). Upon completion of the CMAM program, output data was gathered from both CMAM and RMAT (based upon similar input parameters) and the results compared. Once the two output sets were compared, a sensitivity analysis was conducted on CMAM by altering the assumed failure rate distributions and associated input parameters to determine the effects on output values. Additionally, a Monte Carlo process Simulation package Crystal Ball ® was used to quantify the uncertainties inherent within CMAM results. Finally, based upon the similarities between the RMAT and CMAM programs for calculating a narrow field of failure rate data, parallels were drawn between the two programs.

---

<sup>12</sup> IVA is Intra-vehicle activity, EVA is Extra Vehicular Activity or “SpaceWalk”, and EVR is Extra-Vehicular Robotics.

<sup>13</sup> 60 Internal and 60 External C1 ORUs (120 total) were chosen from the MADS list that were thought to display the same failure rate trends as the entire ORU set.



## B. CMAM

### 1. Basic Functionality

CMAM allows for the calculation of both Corrective Maintenance and Preventative Maintenance Actions as well as the associated required crew maintenance time (in the areas of IVA/EVA/EVR) for a single ORU or a specified set of ORUs. The following figure is a flowchart functionality diagram of CMAM:

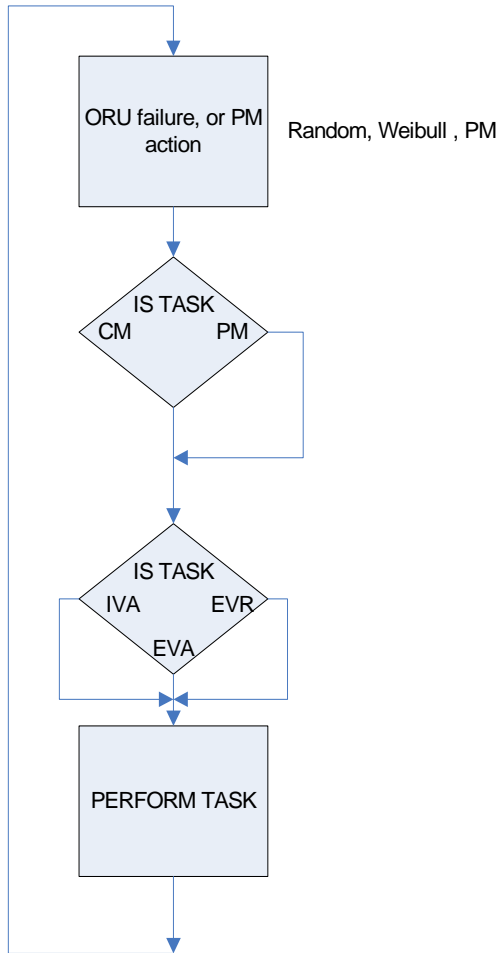

Figure 2. CMAM Functionality Diagram

CMAM calculates ORU failure rates utilizing both random failures and wear-out failures for each ORU. However, CMAM does not model/calculate infant mortality failures at this time. It should be noted that while RMAT has the capability of modeling infant mortality events and “bad apple” failures it can, and

often is turned off.<sup>14</sup> Unlike RMAT, the CMAM program does not take into account a spares list and available crew time – thus it does not calculate any type of backlog (CM/PM maintenance action or crew time backlogs). The following is a diagram that shows the overall functionality of the RMAT program for comparison with CMAM:

---

<sup>14</sup> Early failure modeling options within RMAT include: Fisher Price, Bad Apple, and No Early failure options. No early failure option is often used due to ORU burn-in process conducted by part manufacturers.

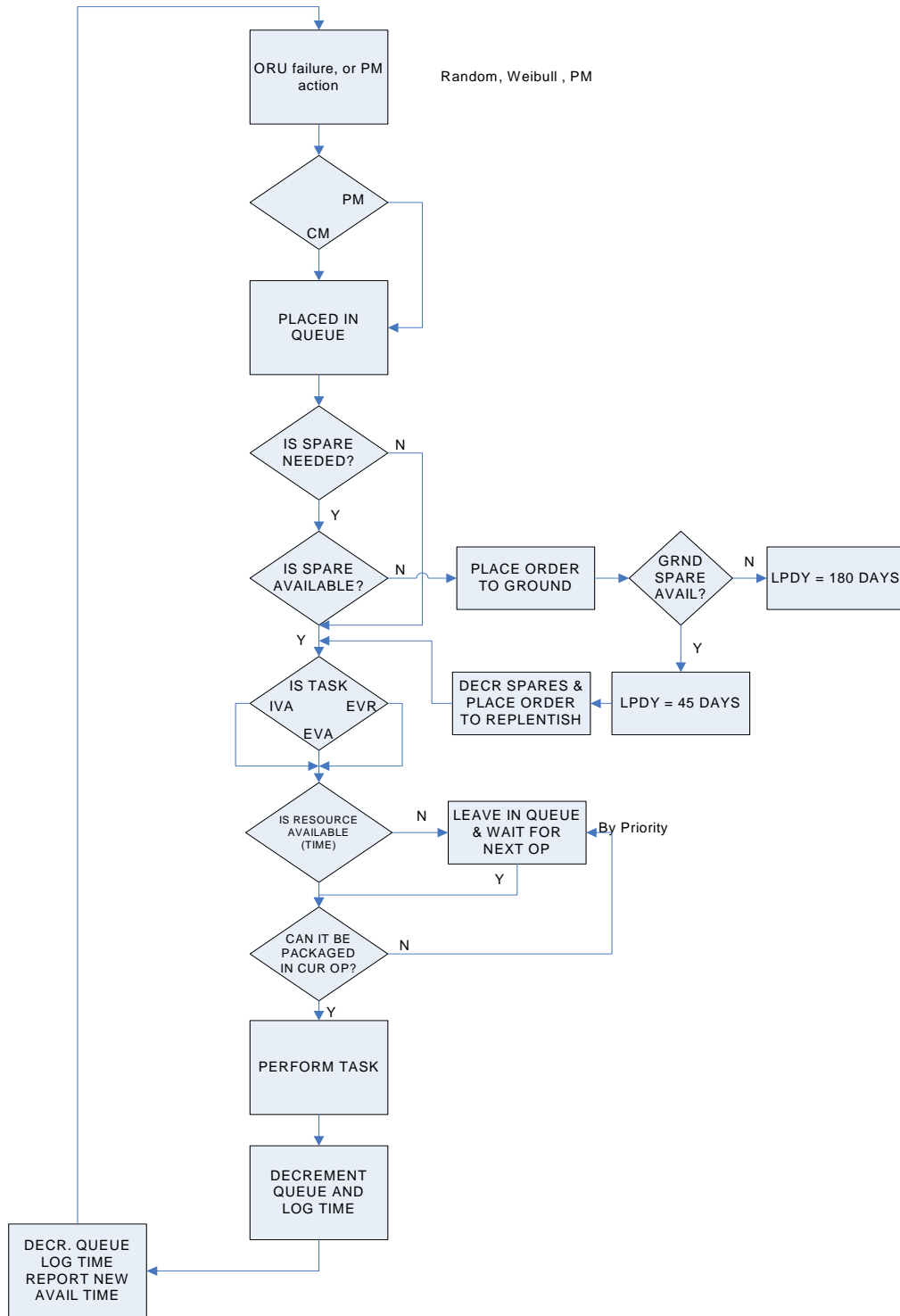

Figure 3. RMAT Functionality Diagram (from: The Boeing Company)

Lastly, CMAM is dynamically linked to a Microsoft Access<sup>®</sup> based ORU database which not only allows for the updating of the database from the CMAM GUI user interface, but also allows for the real time querying of the database for

specific sets of ORUs for failure rate calculation. CMAM is designed with an easy-to-use query form that has the following built-in database query types:

ORU Search By:

- Assembly Flight
- ISS Operational Year (Decimal Dated year)
- ISS Subsystem
- ORU name
- Internal or External Component
- Entire ORU Database

## **2. Database Connectivity**

The CMAM ORU database consists of three tables: an ORU master parts list, an ISS Flight table, and an ISS Subsystem table. The ORU master parts list and the ISS Flight table can be updated or modified from the CMAM user interface.

The current CMAM database is populated with a “representative” set of ORUs for comparison against RMAT and to allow for the assumption that the primary sensitivities of this representative set will also be the primary sensitivities of the ORU database as a whole. For the purposes of this thesis it was time prohibitive to enter the entire MADS ORU database into the CMAM ACCESS ® database. The MADS DB consists of approximately 1380 separate (unique) ORUs with 59 separate fields for each ORU. The CMAM database uses only 26 of these 59 fields. Entry of all 1380 ORUs using the CMAM ORU update mask is estimated to take between 1.5 and 2 minutes per ORU or between 34.5 and 46 hours for the entire ORU database.

The CMAM representative ORU set comprises approximately 8.7% of the MADS database (120 ORUs) and is comprised of the highest criticality components sorted by weight and volume (i.e. the top 60 Criticality Code 1 ORUs with the highest volume and weight requirements to orbit where chosen from both internal and external ORU parts lists). See Appendix 1 for further database details.

### 3. CMAM Distributions

#### a. Overview

A user considers a system reliable if it is available and operational when needed. From an engineering standpoint, reliability is the ability of a system or unit to perform a required function under an assumed or stated set of conditions, for a specified period of time. Quantifying reliability is achieved from the concept of reliability as a probability distribution. The probability of a component surviving to a time  $t$  is the reliability  $R(t)$ , and is expressed as:

$$R(t) = \# \text{ surviving at instant } t / \# \text{ at time } =0$$

A component failure can be classified into two groups: 1.) Degradation failures, where an important subcomponent drifts so far from original tolerance values that the component no longer functions, or 2.) Catastrophic failures, where the component reaches end of life. The failure rate can be expressed as:

$$f(t) = \# \text{ failing per unit time at instant } t / \# \text{ surviving at instant } t$$

The failure rate can therefore be defined as the probability of failure in unit time of a component that is still working satisfactorily.

CMAM assumed two types of failure rates for ORUs: a constant failure rate (to model the random failures that occur during the intrinsic life of the component), and an exponentially increasing failure rate (to model the wear-out failures that occur towards end of life or towards the end of the intrinsic life of the component). The CMAM program mimics RMAAT by using the exponential distribution to model constant rate failures, and the Weibull distribution for modeling the increasing failure rate wear-out failures.

#### b. *The Exponential Distribution*

The exponential distribution is a relatively common distribution in reliability engineering that models the behavior of components that have a constant failure rate and results in the component having a reliability that

exponentially decreases through time. The following equations show the exponential distribution and its important characteristics:

Exponential Distribution (2-parameter):

$$f(t) = \lambda e^{-\lambda(t-\gamma)}$$

where :

$\lambda$  = failure rate

$\gamma$  = location parameter = flight decimal date

$$\text{Reliability} = R(t) = e^{-\lambda(t-\gamma)}$$

$$\text{Failure Rate} = \lambda(t) = \left( \frac{f(t)}{R(t)} \right) = \lambda$$

$$1 / \lambda = \text{MTBF}$$

Figure 4. Exponential Distribution Equations (from: Walpole)

It is important to note that the two-parameter exponential distribution is utilized and coded into CMAM. Since ORUs become activated at different times (flight decimal dates) CMAM is NOT a steady state calculation program.

### **c. The Weibull Distribution**

The Weibull distribution is a general purpose distribution used to model material strength, times-to-failure of electronic and mechanical components, equipment or systems. The most general (3-parameter) case of the Weibull distribution was utilized in CMAM and is defined by the following equations:

## Weibull Distribution (3-parameter):

$$f(t) = \frac{\beta}{\eta} \left( \frac{(t - \gamma)}{\eta} \right)^{(\beta-1)} e^{-\left(\frac{t-\gamma}{\eta}\right)^{\beta}}$$

Where :

$\beta$  = shape parameter = beta

$\gamma$  = location parameter = flight decimal date

$\eta$  = scale parameter = eta

$$\text{Reliability} = R(t) = e^{-\left(\frac{t-\gamma}{\eta}\right)^{\beta}}$$

$$\text{failure rate} = \lambda(t) = \left( \frac{f(t)}{R(t)} \right) = \frac{\beta}{\eta} \left( \frac{(t - \gamma)}{\eta} \right)^{(\beta-1)}$$

$$*MTBF = \gamma + \eta * \Gamma\left(\frac{1}{\beta} + 1\right)$$

$$*MTBF = MTBMA_{total}$$

$$\eta = \left( \frac{MTBMA_{total}}{\Gamma\left(\frac{1}{\beta} + 1\right)} - \gamma \right)$$

$$\text{Gamma Function} = \Gamma(n) = \int_0^{+\infty} e^{-x} * x^{n-1} dx$$

Figure 5. Weibull Distribution Equations (from: Walpole)<sup>15</sup>

The Weibull failure rate is a function of time, however, if the Weibull shape factor ( $\beta$ ) is equal to 1 the Weibull distribution displays a constant failure rate and is in every characteristic identical to the exponential distribution. In fact, shifting the Weibull shape factor ( $\beta$ ) gives indication on all of the prevalent failures modes:

<sup>15</sup> MTBMA<sub>total</sub> (Mean Time Between Maintenance Actions-total) is the adjustment to MTBF values based upon the WP-4 Rutherford equation. See Section 2.4.a

- $\beta < 1$  indicates infant mortality (poor production or insufficient burn in)
- $\beta = 1$  indicates random failures
- $\beta = 1$  to 4 indicates early wear out, early fatigue
- $\beta > 4$  indicates old age or rapid wear-out at end of life

CMAM allows the user to input the desired  $\beta$  value and is meant to be used to model wear-out failures – thus it is defaulted to 5 (similar to the RMAT program).

It is important to note that the Weibull scale parameter ( $\gamma$ ), which is imperative in determining the Weibull failure rate, is based on the Gamma Function. The gamma function computation will be discussed in the next section (CMAM Algorithms).

The following examples show the Weibull failure rates and cumulative probability of a component surviving (reliability) over time for both a long and short MTBF ORU with a beta value of 1:

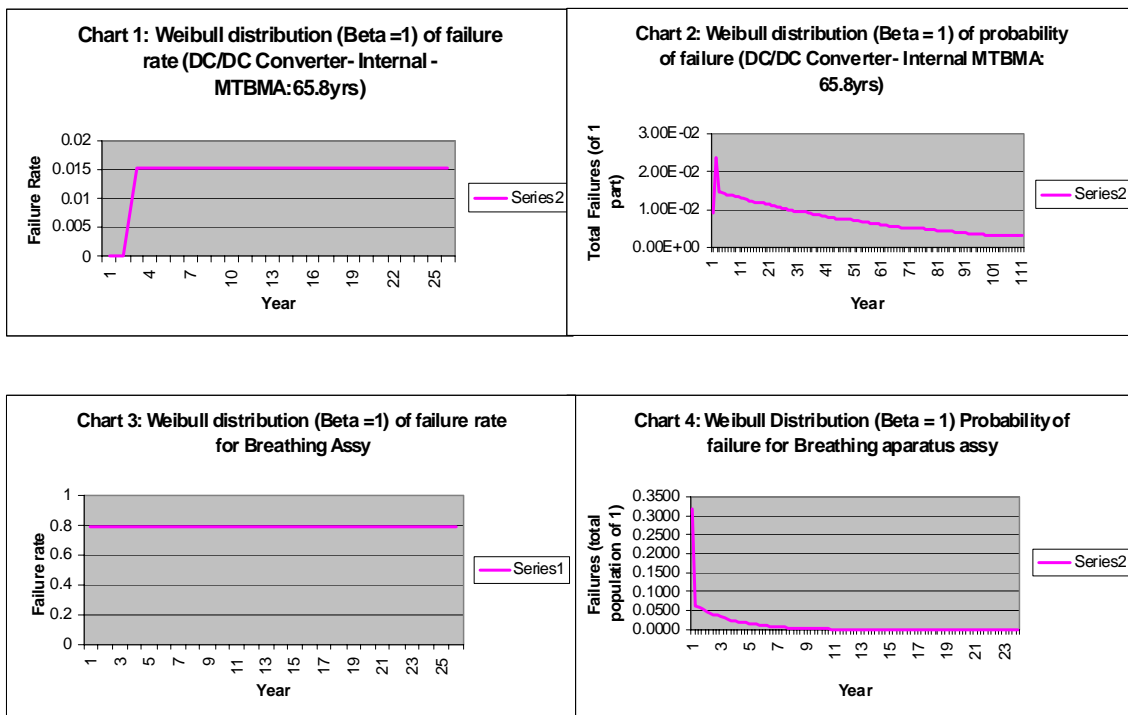

Figure 6. Weibull Distribution Example, Beta = 1



When Weibull shape factor ( $\beta$ ) = 1 the failure rate remains constant, and the reliability of the component exponentially decreases with time. In the graphs above it is important to note how quickly the short MTBMA ORU (Breathing Apparatus Assembly) reliability decreases to approximately zero over the life of the ISS<sup>16</sup> (Chart 4), while the long MTBMA ORU (DC/DC Converter) still has fairly high reliability over the same timeframe.

The following examples show the Weibull failure rates and cumulative probability of a component failing (inverse reliability) over time for both a long and short MTBF ORU with a beta value of 5:

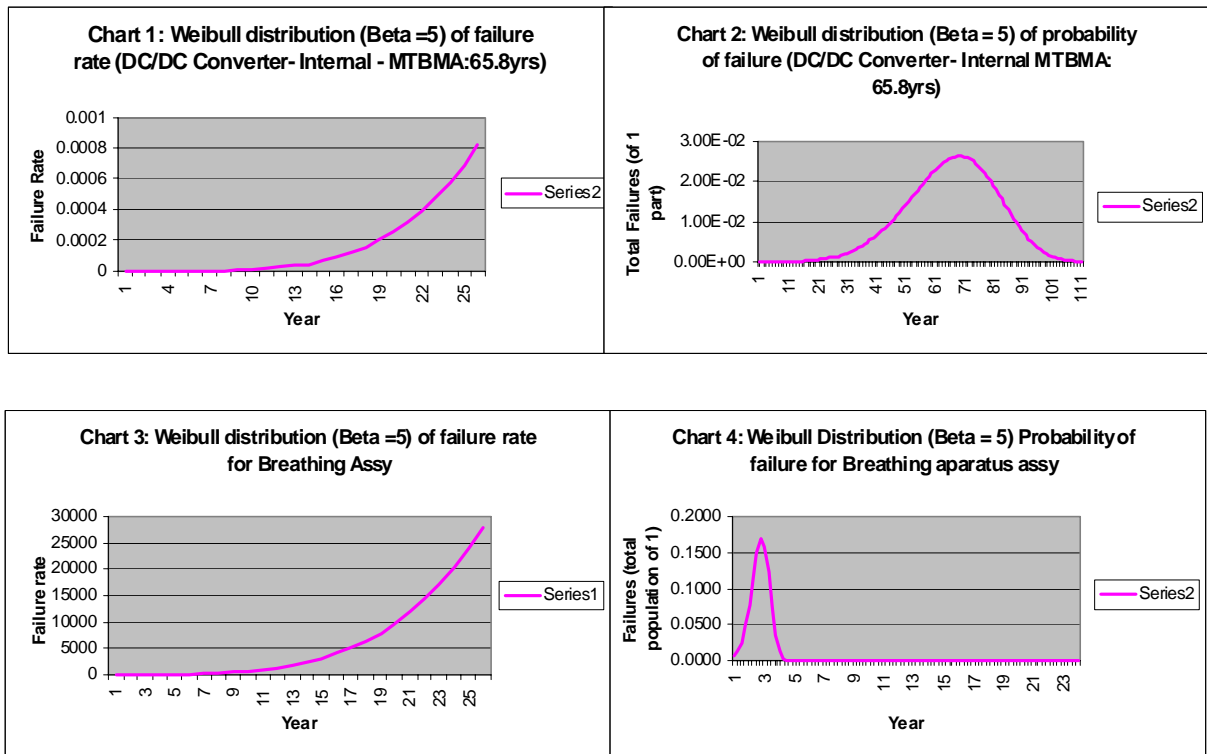

Figure 7. Weibull Distribution Example, Beta = 5

<sup>16</sup> Life of ISS for this thesis study includes assembly and post assembly time and is approximated at 26 years.

With a Weibull shape parameter ( $\beta=5$ ) it is important to note that although the failure rates increase exponentially in a similar fashion, the scaling of those failure rates is radically different for short as opposed to long MTBMA ORUs (charts 1 and 3).

#### **4. CMAM Algorithms**

##### **a. *The Rutherford Equation***

Each assembly, subassembly, or component within the ISS has its own inherent reliability, often expressed as a Mean Time Between Failure (MTBF). Often, MTBF by itself (without any modification) is used as the basis for determining failure rates. This practice can and often does lead to unacceptable inaccuracies in actual (and forecasted) failure rates due to two factors: usage, and the nature of reliability data itself.

MTBF is by definition an average value of failure times based upon a universal population of like devices/components.<sup>17</sup> MTBF therefore does not take into account duty cycles (component hot versus cold usage rates), human error when performing corrective maintenance (K-factor), or other life limiting factors (LifeLim). Due to these issues, the following equations, were developed by L&M personnel and serve as the basis for all MTBF corrections within CMAM for corrective maintenance actions and are summarized as the WP-4 Rutherford equations:

---

<sup>17</sup> Taken from the 15 April 1991 Application of K-factor to Life estimates in External Maintenance Solution Team (EMST) Steady State Algorithm paper.

WP-4 Rutherford Equation:

$$OP = DC + R - (DC * R)$$

$OP = OperatingRatio$

$DC = DutyCycle$

$R = HOTtoColdMTBF = 1 / 35(\text{assumed value})$

$$MTBF_{adj} = \frac{MTBF_{hot}}{OP}$$

$$MTTF_{adj} = MTBF_{adj} \left( 1 - e^{-\left(8760 * \frac{Lchar}{MTBF_{adj}}\right)} \right)$$

$Lchar = LIFLIM (\text{yrs})$

$$MTBM_{Arandom} = \left( \frac{1}{\left( \frac{1}{MTBF_{adj}} + \frac{K-1}{MTTF_{adj}} \right)} \right)$$

$K = Kfactor$

$$MTBM_{Atotal} = MTBM_{Arandom} \left( 1 - e^{-\left(8760 * \frac{Lchar}{MTBM_{Arandom}}\right)} \right)$$

**\*CM**

$$CM / year = \frac{8760 * QTY}{MTBM_{Atotal}}$$

**\*PM**

$$PM / year = \frac{8760 * QTY}{MTBPMRR}$$

Figure 8. Rutherford Equations (from: McDonnell Douglas Space Systems)

Once again it is important to note that Preventative Maintenance (PM) calculations are not a function of  $MTBM_{Atotal}$ , and rely upon stated/unmodified Mean Time Between Preventative Maintenance Remove and Replace (MTBPMRR) times only.

**b. The Gamma Function**

As discussed earlier, the scale parameter ( $\gamma$ ) of the Weibull distribution is dependent on the solution to the Gamma Function which is defined by:

$$\text{Gamma Function} = \Gamma(n) = \int_0^{+\infty} e^{-x} * x^{n-1} dx$$

Integration by parts

$$u = x^{n-1}, dv = e^{-x} dx$$

gives

$$\Gamma(n) = -e^{-x} x^{n-1} \Big|_0^{+\infty} + (n-1) \int_0^{+\infty} e^{-x} * x^{n-2} dx$$

$$= (n-1) * \int_0^{+\infty} e^{-x} * x^{n-2} dx$$

for :  $n > 1 =$

$$\text{recursion formula} = \Gamma(n) = (n-1)\Gamma(n-1)$$

Figure 9. Gamma Function (from: Walpole)

The recursion formula has no algebraic solution thus, in order to code the Weibull distribution into CMAM an estimate for the solution of the Gamma function had to be used. An estimate of the solution to the Gamma function can be attained through the use of Stirling's Asymptotic Series. Stirling's series is as follows:

Stirling's Asymptotic Series

$$\Gamma(n) : e^{-n} n^{(n-1/2)} \sqrt{2\pi} \left( 1 + \frac{1}{12n} + \frac{1}{288n^2} - \frac{139}{51840n^3} - \frac{571}{2488320n^4} \right)$$

Figure 10. Stirling's Asymptotic Series (from: Beyer)

This asymptotic series in the form above is a series expansion of the gamma function accurate to 4 decimal places, which provides reasonable accuracy in failure rate calculation for the purposes of CMAM development.

## 5. CMAM Output

The CMAM output report is in the form of four separate text files that show the following:

- File 1: Maintenance Actions per year
- File 2: IVA crew time requirements per year
- File 3: EVA crew time requirements per year
- File 4: EVR (Robotic) crew time requirements per year

Each of the files is listed per ORU (each line in the report is a separate ORU) with calculations listed by year (the year is listed with the calculation immediately to the right of the year)<sup>18</sup>. Each of the files also has a summary portion that lists both Overall (TOTAL) and Average per year calculations (similar to RMAT calculation results). However, CMAM calculates both CM and PM actions and summarized them in one column (unlike RMAT which has a separate queue (queue 1) for PM calculations). Figure 11 is an example of the CMAM output screen:

---

<sup>18</sup> The Year is defined as the Operational year of the ISS with time = 0 defined as the decimal date of the first assembly flight (AF-01A) which occurred on 20 November 1998.



THIS PAGE INTENTIONALLY LEFT BLANK

### III. RMAT SENSITIVITY ANALYSIS

#### A. RMAT VERSUS CMAM OUTPUT COMPARISON

An attempt was made to directly compare the output of RMAT and CMAM based upon an identical set of input ORUs (the CMAM top 120 critical ORU set), and a similar set of input parameters. The following input parameters were normalized for RMAT/CMAM output comparison:

- Duration of failure rate calculations: 26 years/result format by year
- Random and Wear-out failures calculated
- ORU Beta value set to default value of 5
- Corrective and Preventative Maintenance calculated per ORU

Since RMAT calculations take into consideration spare ORU availability and crew time availability, an infinite spares list and infinite crew time had to be assumed within RMAT (unconstrained spares and crew time run). Additionally, the bad apple and infant mortality functions of RMAT were turned off for the comparison run. The following table is a summary of the RMAT preprocessor input parameters:

RMAT Version 5.9.1      DATE: 08-15-2004      TIME: 18:40:51	
USER NAME: Brian T. Soldon	
DATA DESCRIPTION: Top120 ORU output for CMAM comparison	
*****	
<SPDM = 26.840> <PHC = 0.663> <AC = 32.874>	
1. LENGTH OF SIMULATION (Years).....	26.000
2. NUMBER OF RUNS (Minimum for post processor is 20).	500.
3. REPORT BY (1=TIME PERIOD, 2=FLIGHT) .....	1
4. IF BY TIME, TIME BETWEEN REPORTS (Months).....	12.000
5. TOGGLE MANIFEST FLAG (M=MANIFEST, 0=AC).....	M
6. EARLY FAILURE (0=OFF 1=FISHER PRICE 2=BAD APPLE) .	0
7. REPAIR FLAG (1=REG 2=INF 3=INF w/ROB 4=RES FILE) .	3
8. STATION EVA ALLOCATION (POST PHC) (#EVAs) .....	10.0
9. TIME TO RENEWAL OF STATION EVA ALLOC (Months) .....	1.00
10. ROBOT HRS/TIME UNIT (SPDM) .....	20.00
11. MB FLIGHT TO BEGIN ROBOTIC EVA SUPPORT (SSRMS) ...	20
12. EVA OVER PACK TIME (Hours) .....	2.00
13. THRESHOLD FOR PERFORMING AN EVA (MAN*HRS) .....	12.00
14. ACCOUNT FOR NONPRODUCTIVE EVA TIME (Y/N) .....	Y
15. DISPLAY OR CHANGE IVA PARAMETERS	
16. SPARE FLG (0=NONE 1=INIT 2=INF G&S 3=INF GRND) ...	2
17. PRIORITY TO TRIGGER UNSCHEDULED EVA .....	4
18. TOGGLE SCREEN OUTPUT FLAG .....	N
19. TOGGLE BEEPING FLAG AT THE END OF SIMULATION .....	N
20. RANDOM NUMBER SEED .....	10
UAAA;	

Table 1. RMAT Input parameters



Upon execution of RMAT failure rate calculations it was determined that, over a 26 year period a total of 3069.83 corrective and preventative maintenance actions were forecasted with an average of 118.07 actions per year. Below summarizes the RMAT output results:

RMAT Version 5.9.1    DATE: 07-15-2004    TIME: 18:40:51 USER NAME: Brian T. Soldon DATA DESCRIPTION: Top120 ORU output for CMAM comparison  <<<<< MAINTENANCE ACTION SECTION >>>>>  MAINTENANCE PERFORMED								
TIME	FLIGHT	EVA only	EVR only	Co-op	Tot EVA	Tot EVR	Tot IVA	Total Maint Actions Top120
1.000		0.00	0.00	0.00	0.00	0.00	2.01	2.01
2.000		0.00	0.00	0.00	0.00	0.00	4.02	4.02
3.000		0.02	0.00	0.09	0.11	0.09	74.14	74.25
4.000		0.02	0.00	0.05	0.07	0.05	105.04	105.11
5.000		0.20	0.00	0.13	0.33	0.13	104.39	104.72
6.000		0.95	0.00	1.42	2.37	1.42	112.61	114.98
7.000		0.27	0.00	0.45	0.72	0.45	120.94	121.66
8.000		0.61	0.00	1.92	2.53	1.92	127.43	129.96
9.000		0.47	0.00	0.69	1.16	0.69	120.74	121.9
10.000		1.45	0.00	1.80	3.25	1.80	131.84	135.09
11.000		1.40	0.00	2.27	3.66	2.27	129.61	133.27
12.000		0.23	0.00	1.22	1.45	1.22	121.14	122.59
13.000		0.90	0.00	1.31	2.20	1.31	133.99	136.19
14.000		0.65	0.00	0.79	1.44	0.79	131.18	132.62
15.000		0.78	0.00	0.82	1.60	0.82	136.37	137.97
16.000		0.87	0.00	1.06	1.94	1.06	128.33	130.27
17.000		0.81	0.00	1.66	2.48	1.66	133.08	135.56
18.000		0.89	0.00	1.51	2.39	1.51	131.67	134.06
19.000		0.90	0.00	1.37	2.27	1.37	133.3	135.57
20.000		0.83	0.00	1.33	2.16	1.33	131.22	133.38
21.000		0.81	0.00	1.27	2.09	1.27	132.83	134.92
22.000		0.84	0.00	1.33	2.17	1.33	130.82	132.99
23.000		0.78	0.00	1.15	1.93	1.15	132.54	134.47
24.000		0.97	0.00	1.51	2.49	1.51	150.11	152.6
25.000		0.81	0.00	1.16	1.97	1.16	132.68	134.65
26.000		0.89	0.00	1.30	2.19	1.30	132.78	134.97
TOTAL		17.3	0.00	27.6	45.0	27.6	3024.83	3069.83
AVERAGE		0.67	0.00	1.06	1.73	1.06	116.34	118.07

Table 2. RMAT Maintenance Action output results

Upon execution of CMAM failure rate calculations, it was found that RMAF was forecasting slightly higher failure rates than CMAM for overall failures and averages of required failures per year. CMAM estimated 92.5% of the total CM and PM failures estimated by RMAF<sup>19</sup>. However it was also determined that CMAM output results are highly sensitive to changes in preventative maintenance remove-and-replace (PMRR) scheduling, especially when calculating failures on short MTBF (MTBF<sub>total</sub>)<sup>20</sup> ORUs over long periods of time (i.e. duration of forecast calculations  $\geq 20$  years). This modeling sensitivity was exemplified through changing the preventative maintenance schedule of just 1 ORU within the CMAM database. A CMAM run was executed both with and without preventative maintenance on an external component: Control Moment Gyro (CMG). The two runs resulted in nearly a 50% difference in total maintenance actions required over the 26 year period (all attributed to increases in corrective maintenance requirements on the CMG). The following tables show the results of the CMAM run with and without CMG preventative maintenance:

---

<sup>19</sup> RMAF forecasted failures = 3069.83, CMAM forecasted failures = 2840.14 (CMAM failures / RMAF failures = 92.5%)

<sup>20</sup> MTBF<sub>total</sub> is the adjustment to MTBF values based upon the WP-4 Rutherford Equation discussed in Section 2.4.a.

CMAM Version 3    DATE: 08-15-2004 USER NAME: Brian T. Soldon DATA DESCRIPTION: Top120 ORU output With Preventative Maintenance on CMG (external)				CMAM Version 3    DATE: 08-15-2004 USER NAME: Brian T. Soldon DATA DESCRIPTION: Top120 ORU output Without Preventative Maintenance on CMG (external)			
Time	EVA	IVA	Total Maint Actions Top120	Time	EVA	IVA	Total Maint Actions Top120
1	0.208	9.0323	9.2403	1	0.208	9.0323	9.2403
2	0.208	9.3975	9.6055	2	0.208	9.3975	9.6055
3	1.0838	67.9256	69.0094	3	0.4593	67.9256	68.3849
4	1.8385	100.7378	102.5763	4	1.0471	100.7378	101.7849
5	1.8385	100.7474	102.5859	5	1.0896	100.7474	101.837
6	1.8385	100.7698	102.6083	6	1.2129	100.7698	101.9827
7	2.0077	100.6449	102.6526	7	1.6537	100.6449	102.2986
8	2.0077	106.4453	108.453	8	2.161	106.4453	108.6063
9	2.0077	107.6574	109.6651	9	3.0124	107.6574	110.6698
10	2.0077	107.8614	109.8691	10	4.3365	107.8614	112.1979
11	2.0077	108.1665	110.1742	11	6.2824	108.1665	114.4489
12	2.0077	108.6041	110.6118	12	9.0197	108.6041	117.6238
13	2.0077	109.2142	111.2219	13	12.7387	109.2142	121.9529
14	2.0077	110.0387	112.0464	14	17.6499	110.0387	127.6886
15	2.0077	111.1268	113.1345	15	23.9844	111.1268	135.1112
16	2.0077	112.5334	114.5411	16	31.9938	112.5334	144.5272
17	2.0077	114.3163	116.324	17	41.9501	114.3163	156.2664
18	2.0077	116.5421	118.5498	18	54.146	116.5421	170.6881
19	2.0077	119.2811	121.2888	19	68.8944	119.2811	188.1755
20	2.0077	122.6077	124.6154	20	86.5288	122.6077	209.1365
21	2.0077	126.6026	128.6103	21	107.4033	126.6026	234.0059
22	2.0077	131.354	133.3617	22	131.8924	131.354	263.2464
23	2.0077	136.9525	138.9602	23	160.391	136.9525	297.3435
24	2.0077	143.4966	145.5043	24	193.3146	143.4966	336.8112
25	2.0077	151.0862	153.0939	25	231.0992	151.0862	382.1854
26	2.0077	159.8309	161.8386	26	274.2011	159.8309	434.032
TOTAL	47.1693	2792.973	2840.1424	TOTAL	1466.878	2792.973	4259.8506
AVE/yr	1.814204	107.422	109.2362461	AVE/yr	56.4184	107.422	163.840403

Table 3. CMAM Maintenance Action Output results

CMG With and Without Preventative Maintenance		
YEAR	Maint Actions Required With PM	Maint Actions Required no PM
1	0	0
2	0	0
3	0.6248	0.0003
4	0.8	0.0086
5	0.8	0.0511
6	0.8	0.1744
7	0.8	0.446
8	0.8	0.9533
9	0.8	1.8047
10	0.8	3.1288
11	0.8	5.0747
12	0.8	7.812
13	0.8	11.531
14	0.8	16.4422
15	0.8	22.7767
16	0.8	30.7861
17	0.8	40.7424
18	0.8	52.9383
19	0.8	67.6867
20	0.8	85.3211
21	0.8	106.1956
22	0.8	130.6847
23	0.8	159.1833
24	0.8	192.1069
25	0.8	229.8915
26	0.8	272.9934
TOTAL	19.0248	1438.7338
AVE/YR	0.731723077	55.33591538

Table 4. CMAM CMG Maintenance Action forecasts w/ and w/o PM

The sensitivity of CMAM to changes in preventative maintenance scheduling, especially on short MTBF (MTBMA<sub>total</sub>) ORUs when calculating failures over long period of time, can be attributed to characteristics of the Weibull distribution when calculating wear-out failures. As discussed earlier, when the Weibull shape factor ( $\beta$ ) is greater than four ( $\beta = 5$  in our case) it results in exponentially increasing failure rates as components age (approach end-of-life or wear-out). The goal is to schedule preventative maintenance on these

components prior to corrective maintenance requirements becoming unacceptably high. However, if no preventative maintenance is scheduled, corrective maintenance forecasts on these components will continue to increase exponentially, and will result in high failure rate predictions (unrealistically high in most cases). Thus, it can be said that if a  $\beta$  value of five is used in wear-out failure calculation, it is imperative to accurately schedule preventative maintenance on short MTBF (MTBMA<sub>total</sub>) ORUs.

The current ORU reliability forecasting issue, as stated in LSAR revisions M, N, and O, is that: while Cumulative IVA actual versus forecasted PM and CM maintenance actions and crew times remain relatively accurate (within 23% for PM, and 8% for CM), Cumulative projected EVA crew times “grossly” exceed actions and the EVA numbers continue to diverge<sup>21</sup>. It seems possible that RMAT may have the same sensitivity to preventative maintenance scheduling as CMAM. In order to test this theory, a comparative run was executed in RMAT for CMG failure rates both with and without preventative maintenance over the same period of time (26 years) and with the same Weibull shape parameter ( $\beta=5$ ). It was found that, although corrective maintenance actions increase when no PM was scheduled, the CM actions did not increase exponentially after the CMG wear-out period.<sup>22</sup> The following table summarizes the results of the RMAT run on the CMG with and without preventative maintenance:

---

<sup>21</sup> LSAR (D684-10162-1-1, Revision O details this divergence issue and discusses possible causes on pages 4-1 and 4-2.

<sup>22</sup> The CMG wear-out period is defined as MTBMA<sub>total</sub>  $\approx$  6.5 years

CMG With and Without Preventative Maintenance-RMAT results		
YEAR	Maint Actions Required With PM	Maint Actions Required no PM
1	0	0
2	0	0
3	0.1	0.7
4	0.12	0.94
5	0.1	0.98
6	0.14	0.93
7	0.23	1.07
8	1.07	1.05
9	1.36	1.09
10	1.41	1.18
11	1.16	1.13
12	0.92	1.1
13	0.76	1.02
14	0.58	1.15
15	0.58	1.1
16	0.69	1.09
17	0.9	1.05
18	1.05	1.08
19	1.14	1.09
20	0.98	1.1
21	0.84	1.09
22	0.8	1.04
23	0.7	1.11
24	0.71	1.09
25	0.92	1.04
26	0.93	1.08
TOTAL	18.19	25.3
AVE/YR	0.699615385	0.973076923

Figure 12. RMAT CMG Maintenance Action forecasts w/ and w/o PM

When an RMAT run was executed on all of the 120 representative ORUS (the CMAM database) with and without PM schedules, it was found that RMAT corrective maintenance approximately doubles over a 26 year period while CMAM forecasted CM actions tend to increase exponentially for the same set of ORUs. Thus it can be said that, while RMAT is not nearly as sensitive to lack of preventative maintenance on short MTBF ORUs as CMAM, it does tend to increase maintenance action requirements, and may be a contributing factor to

the overall trend of forecast versus actual failure divergence, especially in reference to external ORUs.

An analysis of the RMAT ORU database (MADS) shows that of the 1379 distinct ORUs within the database 729 are Interior (IVA) ORUs and 650 are Exterior (EVA) ORUs. Of the 729 IVA ORUs, 32 have an associated Mean Time Between Preventative Maintenance Remove and Replace (MTBPMRR), while of the 650 EVA ORUs, only 9 have an associated MTBPMRR. Even more significant is that although exterior components on average have longer lives (longer MTBF/MTBMAtotals), there are still 71 EVA ORUs that have an MTBF less than 100000 hours and only 2 of these ORUs have an associated MTBPMRR (while of the 116 IVA ORUs with an MTBF less than 100000 hours, 18 have preventative maintenance schedules). This fact by itself may be enough to explain the divergence issue with respect to external ORUs while internal forecasts remain fairly accurate.

Lastly, it must be stated that the simple addition of EVA preventative maintenance on short MTBF items does not seem to be the appropriate solution to the problem of exaggerated forecasted EVA failure rates for two reasons:

- Historical/actual EVA maintenance actions (CM) do not seem to merit the addition of such maintenance (LSAR revision O shows only 5 EVA CM actions to date)
- Additional preventative maintenance on EVA components is avoided (if possible) because it is inherently dangerous and time consuming

Thus, it seems more likely that the use of a lower  $\beta$  value for determining wear-out failures should be explored, especially in reference to short MTBF external components. It seems highly likely that  $\beta$  values closer to 1 (constant rate failures) would be more accurate to use based upon the historical/actual failure rates that are collected as the ISS matures.

## **B. CMAM UNCERTAINTY USING CRYSTAL BALL**

So far our discussion and analysis of failure rates for ORUs has centered on the distribution of time between failures (failure rate modes – constant rate and wear-out), as opposed to the accuracy of stated MTBFs and associated

MTBMAtotals. Due to the unique nature of the ISS, and the unique components of its associated systems, reliability analysis of the ISS as a system and its ORUs individually is based upon predicted MTBF and K factor<sup>23</sup> data. This ensures that there will be added levels of uncertainty in ORU failure rates forecasts. The idea is to quantify this uncertainty to the highest degree possible to aid in logistics and maintenance action planning.

## **1. Purpose of Crystal Ball Simulation Package**

The two major sources of uncertainty for failure rate calculations relate to inaccuracies of:

- Mean Time Between Failures: The Average time between failures of a specific ORU based upon characteristics of the ORU itself
- K-Factor: A multiplier that accounts for increased equipment maintenance actions not included in the inherent MTBF estimates. These maintenance actions include: human-induced, environmental induced, false maintenance, other equipment induced.

For the purpose of CMAM uncertainty analysis, these two input parameters were treated as variables in developing failure rate estimates. This was accomplished through the use of the Crystal Ball ® 2000 program.

Crystal Ball 2000 ® is a simulation program that assists in analyzing the risks and uncertainties associated with forecasting models. Crystal Ball was chosen for this uncertainty analysis for the following reasons:

- It allows the incorporation of all assumptions made for CMAM failure rate calculation purposes
- It allows for multiple replications as needed to avoid randomness
- It provides a confidence level for data sensitivity analysis.
- It provides a means of analyzing data by utilizing dissimilar distributions exclusive of the probability distributions functions.<sup>24</sup>

## **2. Assumptions**

In order to simplify this uncertainty analysis a number of assumptions needed to be made:

---

<sup>23</sup> MTBF and K-factor (see Section III.C.1 for definition) are considered to be the two primary causes of uncertainty in failure rate calculation. These factors are taken into account within RMAT (RMAT uses Monte-Carlo simulation with 600 iterations to account for these uncertainty factors).

<sup>24</sup> [http://www.crystalball.com/crystal\\_ball/index.html](http://www.crystalball.com/crystal_ball/index.html), May 15, 2003



- Only constant failure rate Corrective Maintenance action requirements were looked at for all 120 ORUs within the CMAM database.
- All 120 ORUs are assumed to be operational on the ISS (steady state calculation)
- Both the MTBF and K-factor for each ORU have a normal distribution about the stated value and both have a standard deviation about this mean of 10%.
- 600 iterations were performed for each ORU (in order to avoid randomness)
- All ORUs are considered independent of one another, and equally mission critical.

### 3. Crystal Ball Results

Based upon constant failure rate calculation within CMAM a total of 6.38 CM maintenance actions per year can be expected on these 120 ORUs. The following figure shows the CMAM output screen for steady state calculations:

The screenshot displays the 'ISS Comparative Maintenance Analysis Model' software interface. The main window title is 'ORU Comparative Maintenance Model'. Below the title bar, there are menu options for 'Flight List' and 'Help'. The central area features the title 'ISS Comparative Maintenance Analysis Model' in a stylized font, flanked by two images of the International Space Station. Below the title, a prompt reads: 'PLEASE CHOOSE ORU FROM DATABASE OR ENTER A NEW ORU FOR STEADY STATE ANALYSIS'. The interface is divided into several sections:

- Input Fields:** A grid of text boxes for entering ORU details. The current record is 'Record 1 of 120'.
 

ORU Item #	120	LifeLimit	99999999999
PartNum	8260850-901	K Factor	1.59
Part Name	AIO Card	Flt Qty	1
System	C&DH	ROBcode	2
Criticality	C1	ADJ_CMMTTR	0.88
EICM (0=IVA, 1=EVA)	1	ROB_MTTR	10.98
Weight (lbs)	1.5	ADD_IVA_MTTR	0.55
Volume (ft^3)	0	ECSCM	1.49
MTBF	273400	ICSCM	0
Flight	AF-11A	Beta	5
ACDC	1	DFRFAC (R)	0.03
- Steady State Analysis Results:** A box on the right side displays the results of the analysis.
 

Steady State Analysis	
Perform CM Steady State Analysis	
Total CM Actions per year:	6.38053
EVA crew time per year:	5.23510
IVA crew time per year:	38.49435
Robotic crew time per year:	18.06747
- Database Options:** A set of buttons at the bottom left for navigating through the database records: Next, First, Add, Edit, Find, Previous, Last, Delete, Save.
- Exit the Program:** A button at the bottom right to close the application.

Figure 13. CMAM Steady State Output Results

When MTBF and K-factors were assumed to vary (normally disturbed w/ standard deviation of .1) the following results were attained:

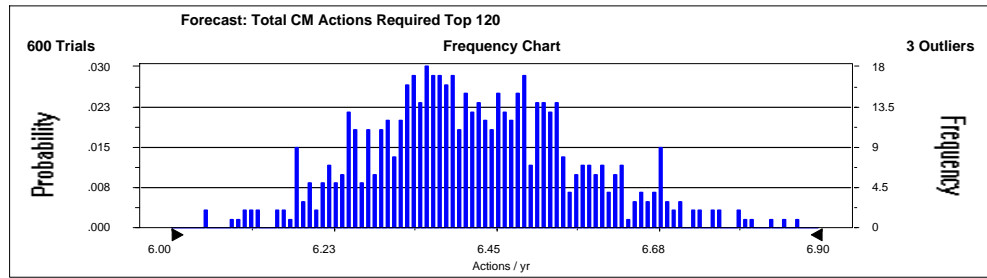

**Forecast: Total CM Actions Required Top 120**

<u>Statistic</u>	<u>Value</u>
<b>Trials</b>	<b>600</b>
<b>Mean</b>	<b>6.42</b>
<b>Range Minimum</b>	<b>6.05</b>
<b>Range Maximum</b>	<b>7.07</b>
<b>Range Width</b>	<b>1.02</b>

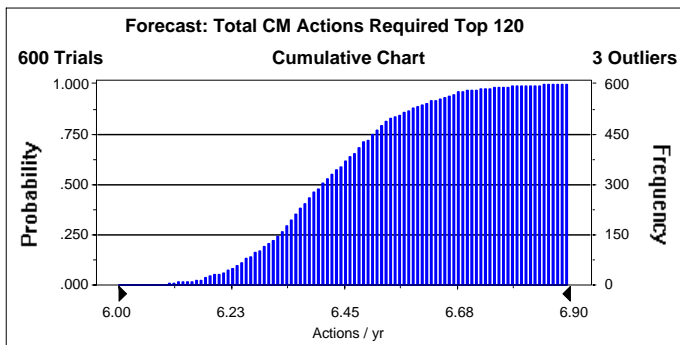

Figure 14. Crystal Ball ®\_ Output results

Thus based upon these simulation input parameters the steady state CM failure rate forecasts can be expected (with 100% certainty) to fluctuate by no more than 15.88% of the mean value (range width of 1.02 with a mean of 6.42). With these figures it can be said that most errors in MTBF and K-factors alone cannot explain the divergence issues in relation to EVA forecasted versus actual maintenance requirements but more likely is a combination of MTBF & K-Factor uncertainty and inappropriate  $\beta$  values when modeling wear-out failures.

THIS PAGE INTENTIONALLY LEFT BLANK

## **IV. RECOMMENDATIONS AND CONCLUSIONS**

### **A. RECOMMENDATION FOR CMAM USE**

The Comparative Maintenance Analysis Tool (CMAM) is a user-friendly alternative to RMAT for executing basic failure rate analysis on Orbital replacement units for the ISS. It can provide immediate feedback for logistics planners on estimates of both corrective and preventative maintenance requirements for both internal and external ORUs. CMAM is not meant as a replacement to the robust capabilities of RMAT, nor has the program been independently validated to ensure that its results are completely accurate. However, when validated it will provide a readily available tool for RMAT comparison that allows for clarification/simplification of the algorithms through which failure rate calculations are made. Therefore, it is recommended that NASA L&M and Boeing L&M consider validating CMAM for use as a reference tool when forecasts from RMAT are either not needed, or when only basic failure rate data is required for planning purposes.

Following this recommendation, the CMAM ORU database should be completed and updated in order to keep CMAM output results as accurate and complete as possible, and to allow for a more meaningful comparison with RMAT results. Completion of this database is estimated to take between 35 and 45 hours of work executed from the CMAM database input mask within the CMAM program. Completion and usage of an Access-based database as opposed to the current Excel-based MADS listing will reduce the overall number of input errors into the ORU database and will most likely reduce the amount of time required to both maintain the database, and the amount of time required to format both CMAM and RMAT input files (through the cut and paste of Access SQL query results).

## **B. RECOMMENDATION FOR FOLLOW-ON RESEARCH**

Based upon the results of the direct comparison between RMAT and CMAM it is recommended that the effects of reduced  $\beta$  values in reference to Weibull wear-out failures rates, as well as the effects of increased EVA MTBPMRR be explored in RMAT to determine the overall effects on failure rate forecasts, especially in reference to short MTBF external ORUs.

Lastly, it is recommended that further research be conducted to find out if a program such as CMAM can be applied to such areas as forecasting failures of submarine components to optimize sparing and/or maintenance scheduling. This research could take significant time in terms of populating new spare part databases with the appropriate reliability data but could provide a better forecasting tool than what is currently in use.

## **C. CONCLUSION**

The International Space Station has a unique Logistics and Maintenance system that requires the efficient and effective forecasting of part failures and associated resource requirements. Due to the complexity of the ISS as a system, and the environment in which it and its crew operates, forecasting these failures is often as much an art as it is a science. Although the primary tool for executing ORU failure rate forecasts (RMAT) is a powerful analytical and simulation based program, it, just like any other probability forecasting tool, has its own set of inefficiencies, inaccuracies and weaknesses. It is of primary importance to identify these weaknesses and their causes as quickly as possible. The growing divergence issue between external ORU forecasted failures and actual failures is an issue that deserves attention and correction. This thesis is an attempt to analyze this issue and its underlying causes. It is believed that, after studying the underlying failure rate calculation algorithms of RMAT and developing an independent program that replicates some of these calculations (CMAM), the underlying problem is a combination of multiple factors. The primary factors are:

- RMAT and CMAM are utilizing Weibull shape parameter ( $\beta$ ) values that are too high in relation to wear-out failure forecasting

- Inherent uncertainty in the accuracy of ORU MTBF and K-factor values that tends to lead to inaccurate failure forecasts rates, especially when looking at a relatively small set of ORUs (120 for this analysis) over a relatively short period of time (approximately 6 years since first assembly flight).

THIS PAGE INTENTIONALLY LEFT BLANK

## **APPENDIX A. CMAM DATABASE**

### **A. INTRODUCTION**

The CMAM ORU database serves as the source of all ORU reliability data ORU failure rate calculation. It provides a way to duplicate the majority of the information within the NASA R&M Modeling Analysis Data Set (MADS). *However*, the CMAM ORU database is not as comprehensive as MADS. For each ORU MADS contains 59 separate fields, where-as the CMAM ORU database has only 26 fields per ORU. However, the CMAM database is a relationship database with 3 separate but dynamically linked tables that can be updated from the CMAM user interface.

### **B. ASSUMPTIONS AND REQUIREMENTS**

#### **Stakeholders**

The stakeholders in the database are the primary NASA L&M planners, NASA R&M personnel, and Boeing L&M personnel.

#### **Query Requirements**

The primary query requirements focus on breaking down ORU failure rate forecasts by ISS assembly flight, and by ISS operational year. However, NASA L&M staff often has analysis requirements that require database drill down capability down to the individual ORU level. Therefore the following ORU query types have been preprogrammed into CMAM:

- Search by Assembly Flight
- Search by ISS Operational Year
- Search by ISS system
- Search by ORU Name
- Search by Internal/External Component

Further database querying is accomplished through SQL formatting in Microsoft Access ® and then inputted into the CMAM program.

### **C. RELATIONS, RELATIONSHIPS, AND CONSTRAINTS**

The CMAM ORU database design was executed through a series of iterative improvements to increase functionality/updatability through the CMAM



user interface. To reduce implementation problems three database design tools were developed:

- Entity Relationship Diagram (ERD)
- Table/Column Diagram
- Microsoft Access Relationship diagram

### **Entity Relationship Diagram (ERD)**

The ERD is a graphical schematic used to represent database entities and their relationships. Entities are shown in rectangles while relationships are shown in diamonds. Cardinalities between entities are within the diamonds. Each entity has a number of attributes that describe it (i.e. the entity *Flight* has the attributes of: Flight\_Num and Flight\_Date). Lastly, relationships bridge the gap between entities. Each relationship has within it a minimum and a maximum cardinality, which, in a binary relationship, identifies the number of elements allowed on each side of the relationship. CMAM has three such relationships that enhance the level of granularity of a users database search. See Figure 15.

### **Table/Column Diagram**

The table/column diagram was then constructed to ensure that the corresponding tables and columns relevant to our ERD were ready for entry into Microsoft Access ® database design. Primary keys for each table were identified, along with ensuring functional dependency of each non-primary attribute (The tables were normalized). See Figure 16.

### **Microsoft Access Relationships**

Lastly, the table/column diagram was translated into the Access® design view and the relationships were linked. One of the key aspects of the CMAM ORU database is that each table and each attribute has specific input requirements (i.e. a field that requires a number will not accept a letter, etc), and referential integrity exists between the tables (i.e. you cannot add an ORU on a flight that doesn't exist). These qualities ensure both data accuracy and integrity on a much higher level than spreadsheets databases (MADS is an excel spreadsheet based database). See Figure 17.

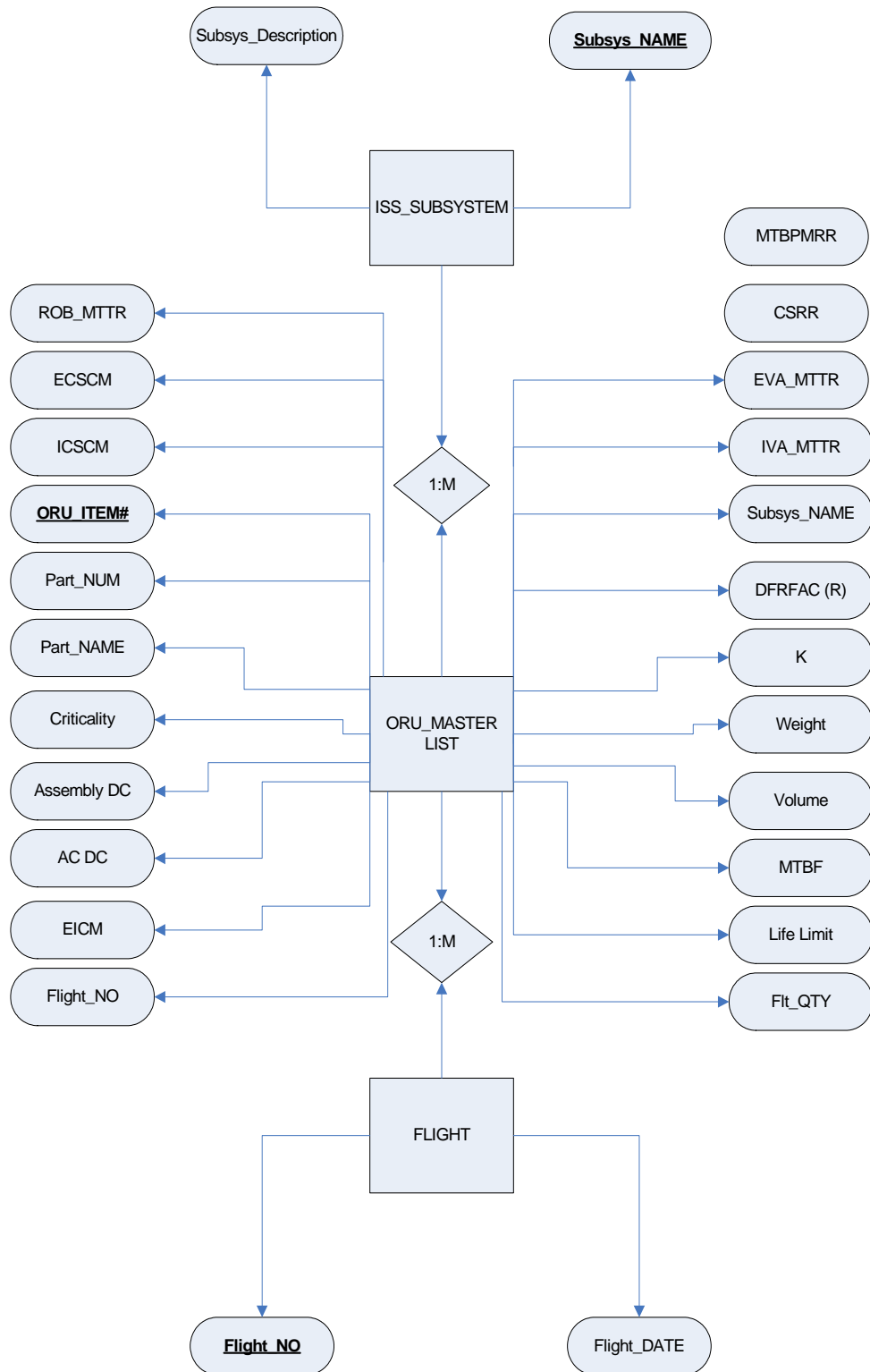

Figure 15. CMAM ORU Database ERD

ORU\_List

<u>ORU_Item#</u>	Part_Num	Part_Name	Criticality	ROB_MTTR	ECSCM	ICSCM
ACDC	Assembly DC	EICM	Flight_No	EVA_MTTR	IVA_MTTR	Subsys_Name
DFRFAC	K	Weight	Volume	MTBF	MTBPMRR	CSRR
LifLimit	Flt_Qty					

ISS\_SUBSYSTEM

<u>Subsys_Name</u>	ISS_Sub Description
--------------------	---------------------

FLIGHT

<u>Flight_No</u>	Flight_Date
------------------	-------------

Figure 16. CMAM ORU Database Table/Column Diagram

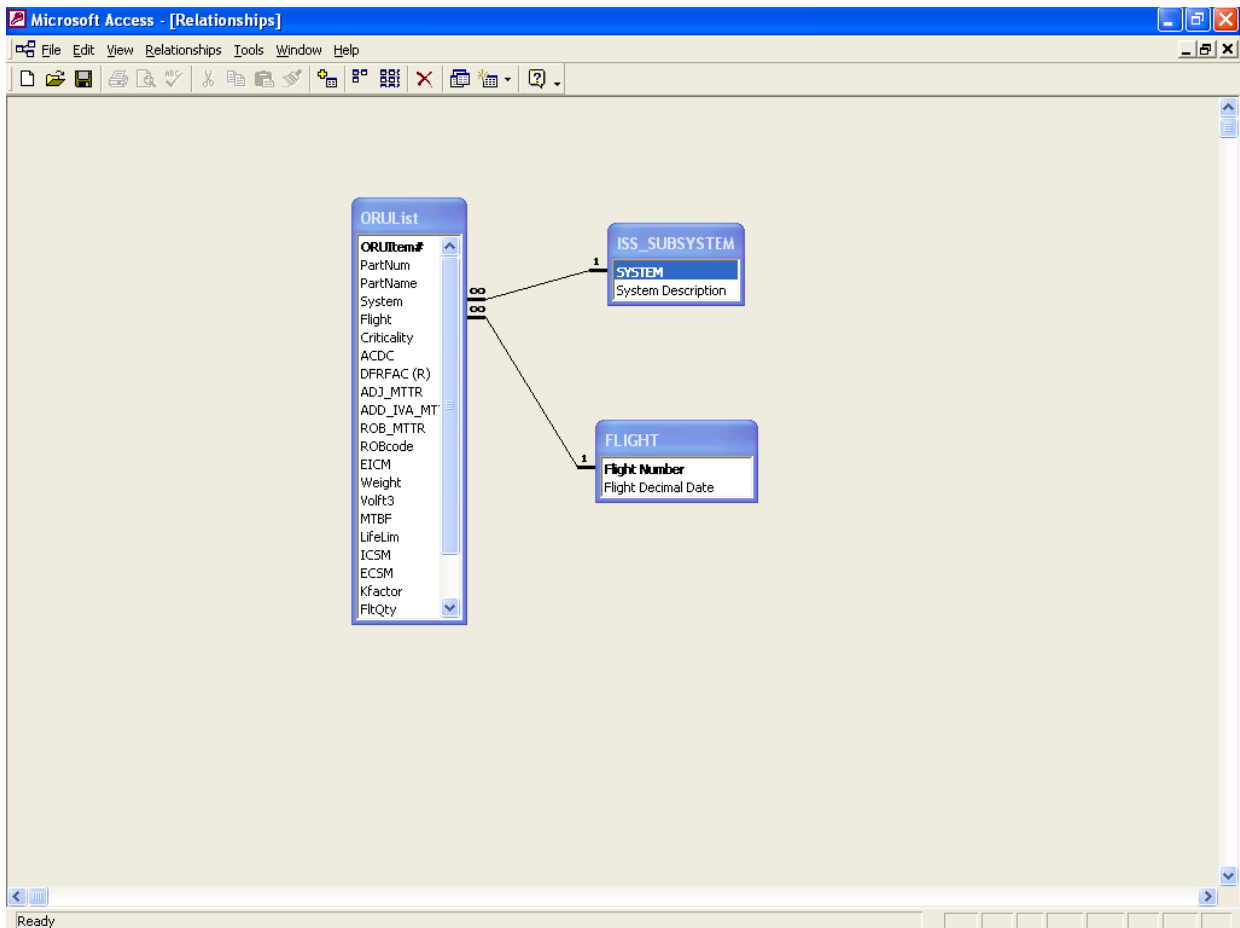

Figure 17. CMAM ORU Microsoft Access Relationship

## D. USER INTERFACE

The CMAM ORU database interface is through two separate forms that allow for the dynamic update of both the ORUlist table and the Flight table. The flight table input mask offers the added functionality of allowing standard dates to be entered (MM/DD/YY) and automatically converting them to decimal dates. (See Figures 18 and 19).

PLEASE CHOOSE ORU FROM DATABASE OR ENTER A NEW ORU FOR STEADY STATE ANALYSIS

ORU Item #	<input type="text" value="1"/>	LifeLimit	<input type="text" value="9999999999"/>
PartNum	<input type="text" value="R076500-161"/>	K Factor	<input type="text" value="1.38"/>
Part Name	<input type="text" value="DC/DC Converter Unit ("/>	Flt Qty	<input type="text" value="1"/>
System	<input type="text" value="EPS"/>	ROBcode	<input type="text" value="0"/>
Criticality	<input type="text" value="C1"/>	ADJ_CMMTTR	<input type="text" value="9"/>
EICM (0=IVA, 1=EVA)	<input type="text" value="0"/>	ROB_MTTR	<input type="text" value="31.99"/>
Weight (lbs)	<input type="text" value="107"/>	ADD_IVA_MTTR	<input type="text" value="0"/>
Volume (ft^3)	<input type="text" value="2.94"/>	ECSCM	<input type="text" value="0"/>
MTBF	<input type="text" value="795491"/>	ICSCM	<input type="text" value="1"/>
Flight	<input type="text" value="AF-06A"/>	Beta	<input type="text" value="5"/>
ACDC	<input type="text" value="1"/>	DFRFAC (R)	<input type="text" value="0.03"/>
MTBPMRR (0 = none)	<input type="text" value="0"/>	Record 1 of 120	
CSRR	<input type="text" value="0"/>		

Database Options

Next First Add Edit Find

Previous Last Delete Save

Exit the Program

ACDC	ADD_IVA_MT	ADJ_MTTR	Beta	Criticality	CSRR	DFRFAC (R)	ECSCM	Eli
1	0	9	5	C1	0	0.03	0	0
1	0	3.35	5	C1	0	0.03	1.9	1
1	0.97	1.68	5	C1	0	0.03	1.9	1

Figure 18. CMAM ORULIST Table User Interface

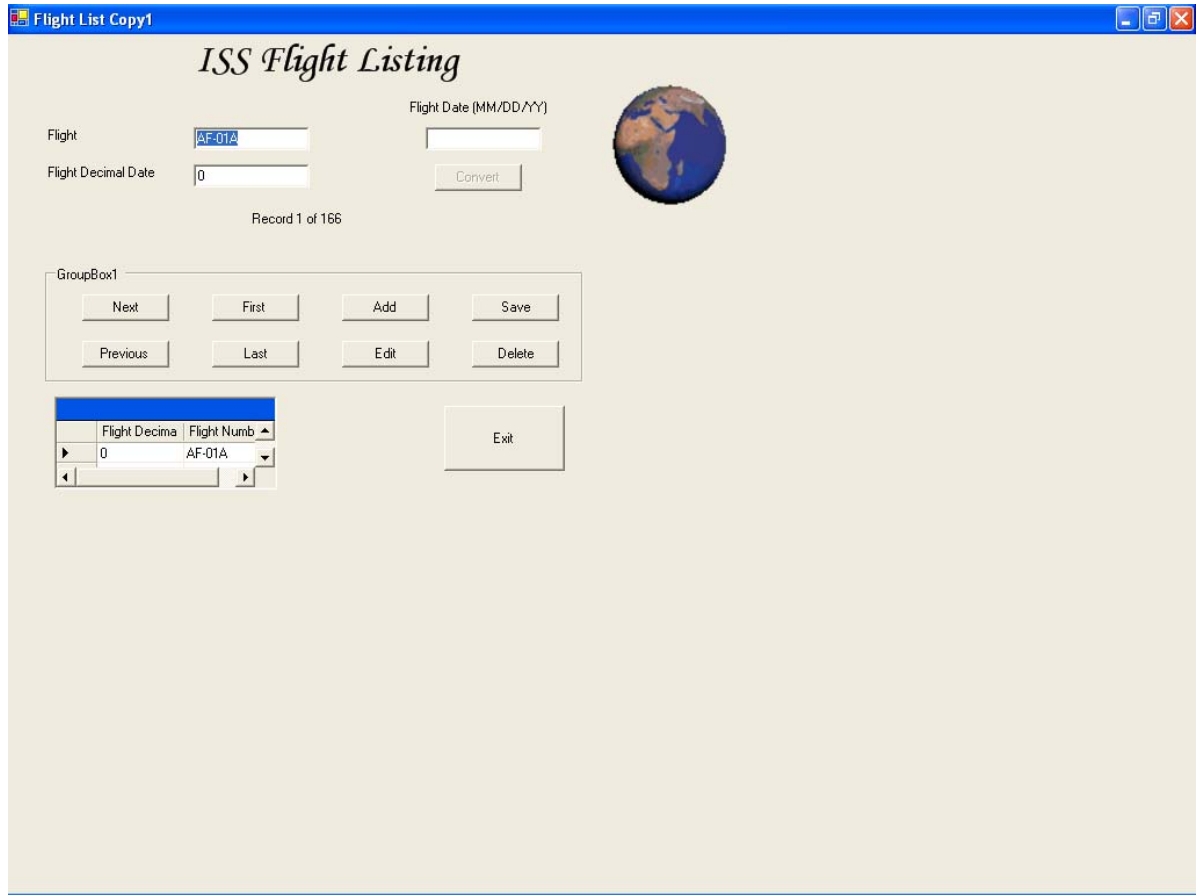

Figure 19. CMAM FLIGHT Table User Interface

## APPENDIX B. LIST OF ABBREVIATIONS AND ACRONYMS

AC	Assembly Complete
ACDC	Assembly Complete Duty Cycle
CMAM	Comparative Maintenance Assessment Tool
CMG	Control Moment Gyro
CM	Corrective Maintenance
C1	Criticality Code 1
C&T	Command & Telemetry
CSRR	Crew Size Removal and Replace
DC	Duty Cycle
DECR	Decrement
ECSCM	External Crew Size Corrective Maintenance
EICM	External/Internal Corrective Maintenance
EMST	External Maintenance Solution Team
ERD	Entity Relationship Diagram
EVA	Extra-Vehicular Activity
Flt_Qty	Flight Quantity
Flight_No	Flight Number
GAO	General Accounting Office
GUI	Graphic User Interface
GRND	Ground
ICSCM	Internal Crew Size Corrective Maintenance
ISS	International Space Station
ITCS	Internal Thermal Control System

IVA	Intra-Vehicular Activity
IVR	Intra-Vehicular Robotics
JSC	Johnson Space Center
KSC	Kennedy Space Center
LIFLIM	Life Limit
Lchar	Life Characteristic
L&M	Logistics and Maintenance
LSAR	Logistics Supportability Assessment Report
MADS	Modeling Analysis Data Set
MTBF	Mean Time Between Failures
MTBMAtotal	Mean Time Between Maintenance Actions total
MTBPMRR	Mean Time Between Preventative Maintenance Remove and Replace
MTTF	Mean Time To Fail
MTTR	Mean Time To Repair
NASA	National Aeronautics and Space Administration
OEM	Original Equipment Manufacturer
OP	Operating ratio
ORU	Orbital Replacement Unit
PM	Preventative Maintenance
PMRR	Preventative Maintenance Remove and Replace
RMAT	Reliability and Maintainability Assessment Tool
R&M	Reliability and Maintenance
ROBMTTR	Robotic Mean Time To Repair

SQL	Structured Query Language
START	Station Availability Reporting Tool
THC	Temperature and Humidity Control
USA	United Space Alliance
VB.net	Visual Basic.net



THIS PAGE INTENTIONALLY LEFT BLANK

## LIST OF REFERENCES

- Beardmore, R. *Failure Distributions*,  
[http://www.roymech.co.uk/Useful\\_Tables/ARM/Failure\\_Distributions.html](http://www.roymech.co.uk/Useful_Tables/ARM/Failure_Distributions.html) ,  
accessed 16 April 2004.
- Beyer, W. H. (1987) *Standard Mathematical Tables* (28<sup>th</sup> ed.). Boca Raton: CRC Press, Inc.
- The Boeing Company. (2002, December). *International Space Station Program Logistics Supportability Assessment Report D684-10162-1-2 Revision M*. Houston: Author.
- The Boeing Company. (2003, July). *International Space Station Program Logistics Supportability Assessment Report D684-10162-1-2 Revision N*. Houston: Author.
- The Boeing Company. (2004 January). *International Space Station Program Logistics Supportability Assessment Report D684-10162-1-2 Revision O*. Houston: Author.
- The Boeing Company. (1998 November). *D684-10708-3 Revision B*. Houston: Author.
- The Boeing Company. (2000 March). *D684-10708-3 Revision E*. Houston: Author.
- The Boeing Company. (1995). *RMAT 5.9.0 Quick Reference Manual*. Houston: Author.
- Byron, Dan. *Increasing Availability at the Cost of Reliability*,  
[http://www1.us.dell.com/content/topics/global.aspx/power/en/ps1q02\\_byron?c=us&1=en&s=corp](http://www1.us.dell.com/content/topics/global.aspx/power/en/ps1q02_byron?c=us&1=en&s=corp) , accessed 12 August 2004.
- Decisioneering, Inc. (1996). *Crystal Ball Version 4.0 User Manual*. Aurora, CO: Author.
- Halvorson, M. (2003). *Microsoft Visual Basic.Net Step by Step: Version 2003*. Redmond: Microsoft Press.
- McDonnell Douglas Space Systems Company. (1991, April). *Application of K-Factor to Life Estimates in the EMST Steady State Algorithm*. Houston: Author.
- National Aeronautics and Space Administration. (2004 March) *International Space Station Logistics and Maintenance Overview*. Houston: Author.

National Institute of Standards and Technology. *NIST/SEMATECH e-Handbook of Statistical Methods*, <http://www.itl.nist.gov/div898/handbook/> , accessed 16 April 2004.

Walpole, R. E., & Myers, R. H. (1989). *Probability and Statistics for Engineers and Scientists* (4<sup>th</sup> ed.). New York: MacMillan Publishing Company.

## BIBLIOGRAPHY

- Bukulich, F. *Managing a Space Station*,  
<http://www.sae.org/aeromag/features/spacestation/> , accessed 16 April 2004.
- Butina, A. (2001). *Managing NASA's International Space Station Logistics and Maintenance Program*. AIP Conference Proceeding Vol. 552 pp.161-169.
- Hoffer, J. A., & Prescott, M. B. (2002). *Database Management* (6<sup>th</sup> ed.). Upper Saddle River, NJ: Pearson Education, Inc.
- National Aeronautics and Space Administration. (2002). *International Space Station User's Guide-Release 2.0*. Houston: Author.
- Sargent, R. G. (2000) *VERIFICATION, VALIDATION, AND ACCREDITATION OF SIMULATION MODELS*. Syracuse: Simulation Research Group, Department of Electrical Engineering and Computer Science, Syracuse University.

THIS PAGE INTENTIONALLY LEFT BLANK

## INITIAL DISTRIBUTION LIST

1. Defense Technical Information Center  
Ft. Belvoir, Virginia
2. Dudley Knox Library  
Naval Postgraduate School  
Monterey, California
3. Tony Butina  
NASA Logistics and Maintenance  
Houston, Texas
4. Paul Rathbun  
NASA Logistics and Maintenance  
Houston, Texas
5. Jesse Astorga  
Boeing Logistics and Maintenance  
Houston, Texas
6. Professor Chiold Epp  
Naval Postgraduate School  
Monterey, California
7. Captain Daniel Bursch  
Naval Postgraduate School  
Monterey, California