



Calhoun: The NPS Institutional Archive
DSpace Repository

NPS Scholarship

Theses

1981

Control strategies of an inverted pendulum.

Harding, Richard Warren

Monterey, California. Naval Postgraduate School

<https://hdl.handle.net/10945/20475>

This publication is a work of the U.S. Government as defined in Title 17, United States Code, Section 101. Copyright protection is not available for this work in the United States.

Downloaded from NPS Archive: Calhoun



Calhoun is the Naval Postgraduate School's public access digital repository for research materials and institutional publications created by the NPS community. Calhoun is named for Professor of Mathematics Guy K. Calhoun, NPS's first appointed -- and published -- scholarly author.

Dudley Knox Library / Naval Postgraduate School
411 Dyer Road / 1 University Circle
Monterey, California USA 93943

<http://www.nps.edu/library>

DUDLEY KNOX LIBRARY
NAVAL POSTGRADUATE SCHOOL
MONTEREY, CALIF. 93940

NAVAL POSTGRADUATE SCHOOL

Monterey, California

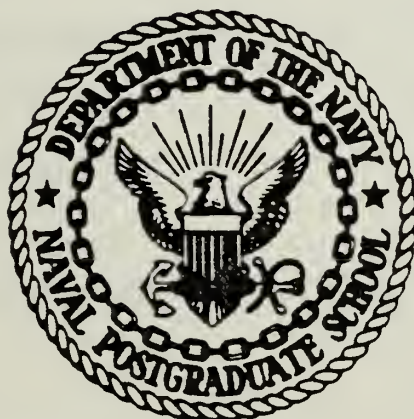

THESIS

CONTROL STRATEGIES OF AN INVERTED PENDULUM

by

Richard Warren Harding

September 1981

Thesis Advisor:

D. J. Collins

Approved for public release; distribution unlimited.

T202283

REPORT DOCUMENTATION PAGE		READ INSTRUCTIONS BEFORE COMPLETING FORM
1. REPORT NUMBER	2. GOVT ACCESSION NO.	3. RECIPIENT'S CATALOG NUMBER
4. TITLE (and Subtitle) Control Strategies of an Inverted Pendulum		5. TYPE OF REPORT & PERIOD COVERED Master's Thesis; September 1981
7. AUTHOR(s) Richard Warren Harding		6. PERFORMING ORG. REPORT NUMBER
9. PERFORMING ORGANIZATION NAME AND ADDRESS Naval Postgraduate School Monterey, California 93940		8. CONTRACT OR GRANT NUMBER(s)
11. CONTROLLING OFFICE NAME AND ADDRESS Naval Postgraduate School Monterey, California 93940		10. PROGRAM ELEMENT, PROJECT, TASK AREA & WORK UNIT NUMBERS
14. MONITORING AGENCY NAME & ADDRESS (if different from Controlling Office)		12. REPORT DATE September 1981
		13. NUMBER OF PAGES 65
		15. SECURITY CLASS. (of this report) Unclassified
		15a. DECLASSIFICATION/DOWNGRADING SCHEDULE
16. DISTRIBUTION STATEMENT (of this Report) Approved for public release; distribution unlimited.		
17. DISTRIBUTION STATEMENT (of the abstract entered in Block 20, if different from Report)		
18. SUPPLEMENTARY NOTES		
19. KEY WORDS (Continue on reverse side if necessary and identify by block number) Inverted Pendulum Unstable mechanical system Automatic control		
20. ABSTRACT (Continue on reverse side if necessary and identify by block number) In a space booster on takeoff, a control system must be employed to prevent the rocket from falling over as it is forced upward by the engines. One accurate dynamic model of the space booster on takeoff is the inverted pendulum. This paper investigated the inverted pendulum system from development of equations of motion, through implementation of an actual inverted pendulum system using state variable feedback		

#20 - ABSTRACT - (CONTINUED)

control. The concept of state variable feedback was analyzed in determining a solution to the problem of control of the inverted pendulum.

Most importantly, design and construction of a working, solid state controlled, inverted pendulum demonstration model was accomplished.

Approved for public release; distribution unlimited.

Control Strategies of an Inverted Pendulum

by

Richard Warren Harding
Lieutenant Commander, United States Navy
B.S., North Carolina State University, 1971

Submitted in partial fulfillment of the
requirements for the degree of

MASTER OF SCIENCE IN AERONAUTICAL ENGINEERING

from the

NAVAL POSTGRADUATE SCHOOL
September 1981

ABSTRACT

In a space booster on takeoff, a control system must be employed to prevent the rocket from falling over as it is forced upward by the engines. One accurate dynamic model of the space booster on takeoff is the inverted pendulum.

This paper investigated the inverted pendulum system from development of equations of motion, through implementation of an actual inverted pendulum system using state variable feedback control. The concept of state variable feedback was analyzed in determining a solution to the problem of control of the inverted pendulum.

Most importantly, design and construction of a working, solid state controlled, inverted pendulum demonstration model was accomplished.

TABLE OF CONTENTS

I.	INTRODUCTION -----	9
II.	PROBLEM FORMULATION -----	11
	A. INVERTED PENDULUM EQUATIONS OF MOTION -----	11
	B. DETERMINATION OF SYSTEM PHYSICAL CONSTANTS ---	15
	C. STATE VARIABLE FORMULATION -----	18
	D. DETERMINATION OF STABILITY -----	20
	E. CONTROLLABILITY -----	21
	F. OBSERVABILITY -----	23
III.	STATE VARIABLE FEEDBACK -----	26
	A. STATE VARIABLE FEEDBACK CONTROL INTRODUCTION -	26
	B. FULL STATE VARIABLE FEEDBACK CONTROL -----	28
IV.	CONSTRUCTION OF INVERTED PENDULUM MODEL -----	32
V.	CONCLUSIONS AND RECOMMENDATIONS -----	44
	A. CONCLUSIONS -----	44
	B. RECOMMENDATIONS -----	45
	APPENDIX A: SENSOR MEASUREMENTS -----	47
	APPENDIX B: PROBLEM SIMULATION -----	57
	LIST OF REFERENCES -----	64
	INITIAL DISTRIBUTION LIST -----	65

LIST OF TABLES

TABLE		PAGE
1	PENDULUM POTENTIOMETER MEASUREMENT -----	48
2	WHEEL POTENTIOMETER MEASUREMENT -----	49
3	MOTOR TACHOMETER MEASUREMENTS -----	51
4	PENDULUM TACHOMETER MEASUREMENT -----	53
5	STATE VARIABLE FEEDBACK DATA TABLE -----	58

LIST OF FIGURES

FIGURE		PAGE
1	FORCE DIAGRAMS OF CART AND PENDULUM -----	12
2	FULL STATE VARIABLE FEEDBACK CONTROL SYSTEM -	31
3	CART QUARTER VIEW -----	34
4	CART TOP VIEW -----	35
5	CONTROLLER/POWER SUPPLY--INSIDE VIEW -----	36
6	INVERTED PENDULUM SYSTEM DEMONSTRATION SETUP -----	37
7	CONTROLLER CIRCUITRY -----	40
8	PENDULUM POTENTIOMETER MEASUREMENT CURVE ----	50
9	WHEEL POTENTIOMETER MEASUREMENT CURVE -----	52
10	MOTOR TACHOMETER MEASUREMENT CURVE -----	54
11	PENDULUM TACHCMETER MEASUREMENT CURVE -----	56
12	u vs. T STATE VARIABLE FEEDBACK -----	59
13	x_1 vs. T STATE VARIABLE FEEDBACK -----	60
14	x_2 vs. T STATE VARIABLE FEEDBACK -----	61
15	x_3 vs. T STATE VARIABLE FEEDBACK -----	62
16	x_4 vs. T STATE VARIABLE FEEDBACK -----	63

ACKNOWLEDGMENTS

I would like to thank all the people, without the help of whom, this thesis could not have been completed.

I thank my wife and family for their patience and support during my two years here at the NPS and especially during the past three quarters.

I would also like to thank the following Aeronautical Engineering Department technicians for their knowledgeable assistance with my thesis: Mr. Bob Besel, Mr. Rafugio Garcia, Mr. Glen Middleton, Mr. Theodore Dunton, and Mr. Ronald Ramaker.

Last, I would like to thank my thesis advisor, Professor D.J. Collins.

I. INTRODUCTION

In the study of Automatic Control Systems, it is not uncommon to encounter a plant which is inherently unstable. This paper investigated the inverted pendulum as an example of an unstable system which could demonstrate many of the basic aspects of control theory, and at the same time be constructed for use as a classroom model in Naval Postgraduate School's Aeronautical Engineering Advanced Control Theory course.

The inverted pendulum is a model of the attitude control of a space booster on take-off. The objective of the attitude control is to keep the space booster in a vertical position.

The system considered was a four-wheeled cart on which a bearing mounted inverted pendulum was installed. For this thesis, a cart was designed and constructed keeping in mind that overall size and weight should be minimized by using current solid state technology for the electronic controls and power supply.

The cart is driven by a small D.C. servomotor which is geared to one pair of wheels through an axle. The cart can move in only one horizontal axis in both positive and negative directions. The voltage applied to the motor comes from sensor signals describing the position and motion of the free pendulum and the position and motion of the cart.

The sensors used are a permanent magnet tachometer geared to the pendulum to measure rate of pendulum movement about the

pivot, potentiometers which measure pendulum angle and cart position (using the second axle/wheel combination), and a tachometer within the motor housing to measure cart velocity.

The pendulum/cart assembly represents the plant, and the plant is unstable since the pendulum cannot remain upright without help of a force from the motor/wheel combination to keep the cart directly underneath the vertical pendulum. The objective of the automatic control system for the inverted pendulum system is to keep the pendulum in as nearly a vertical position as possible while returning the cart itself to its starting position.

Analysis of the system started with the development of the equations of motion for the inverted pendulum and cart; expression of the linearized and simplified equations in state variable notation; development of a control law for full state variable feedback; and construction of a working model of the inverted pendulum.

II. PROBLEM FORMULATION

A. INVERTED PENDULUM EQUATIONS OF MOTION

Consider an inverted pendulum with the pivot of the pendulum mounted on a motorized cart which can move in the horizontal direction. The cart is drive by a small D.C. Servomotor that exerts a force $u(t)$ on the cart.

System Variable Notation (refer to figure 1)

- $s(t)$ - displacement of the pivot point
- $\phi(t)$ - angular rotation of the pendulum from vertical.
- m - mass of the pendulum
- M - mass of the cart
- λ - total length of the pendulum
- L - distance from pivot to center of gravity of the pendulum
- L' - effective pendulum length. ($L' \equiv \frac{J + mL^2}{mL}$)
- J - moment of inertia of the pendulum with respect to the c.g.
- $H(t)$ - horizontal reaction force in the pivot
- $V(t)$ - vertical reaction force in the pivot
- $u(t)$ - force exerted on the cart by the motor
- F - viscous friction coefficient of the cart (includes friction, gearing losses, back EMF of the motor, etc.)
- g - gravitational acceleration

Pendulum Equations

$$\{F_x = m \frac{d^2}{dt^2} [s(t) + L \sin \phi(t)] = H(t) \quad (1)$$

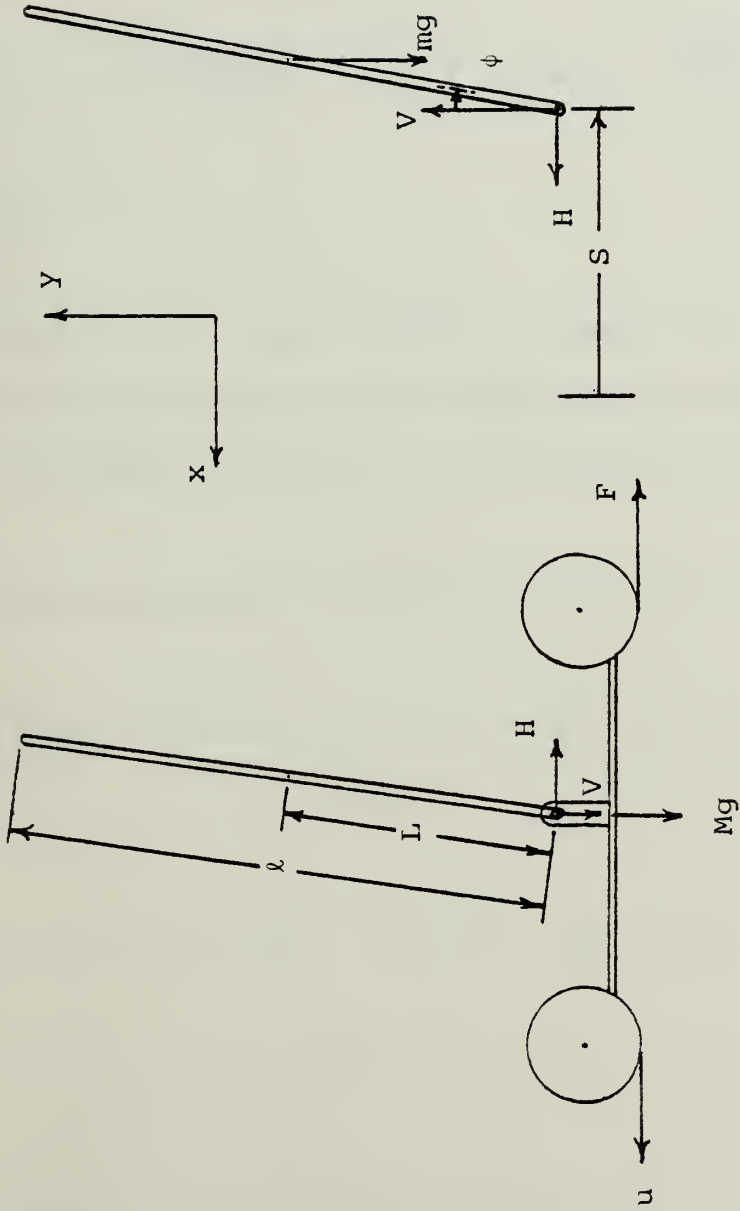

FIGURE 1. FORCE DIAGRAMS OF CART AND PENDULUM

$$\{F_Y = m \frac{d^2}{dt^2}[L \cos \phi(t)] = V(t) - mg \quad (2)$$

$$\{T = J \frac{d^2 \phi(t)}{dt^2} = V(t) L \sin \phi(t) - H(t) L \cos \phi(t) \quad (3)$$

Cart Equations

$$\{F_x = M \frac{d^2 s(t)}{dt^2} = u(t) - H(t) - F \frac{ds(t)}{dt} \quad (4)$$

$$\{F_y = 0 \quad (5)$$

The friction term F is due to the cart motion. The frictions of the pendulum pivot bearings, the pendulum potentiometer, and the pendulum tachometer have been neglected. [Reference 1]

Differentiation of the above equations yields:

$$\begin{aligned} m \ddot{s}(t) + m L \ddot{\phi}(t) \cos \phi(t) - m L \dot{\phi}^2(t) \sin \phi(t) \\ = H(t) \end{aligned} \quad (6)$$

$$-m L \ddot{\phi}(t) \sin \phi(t) - m L \dot{\phi}^2(t) \cos \phi(t) = V(t) - mg \quad (7)$$

$$J \ddot{\phi}(t) = V(t) L \sin \phi(t) - H(t) L \cos \phi(t) \quad (8)$$

$$M \ddot{s}(t) = u(t) - H(t) - F \dot{s}(t) \quad (9)$$

Note: For simplification, all independent variables which are functions of time will have (t) assumed but not displayed.

Equation Linearization

Assume that the mass of the pendulum (m) is small with respect to the mass of the cart (M) so that $H(t)$ may be neglected on the cart motion.

Assume that the perturbation angle of the pendulum will always be small so that the small angle approximation may be used to linearize the equations. Therefore, $\sin \phi(t) \doteq \phi(t)$ and $\cos \phi(t) \doteq 1$. Also neglect products of higher order derivatives of ϕ .

By combining the pendulum and cart equations and then rearranging them, one obtains:

$$\ddot{s} = \frac{-F}{M} \dot{s} + \frac{1}{M} u \quad (10)$$

$$\ddot{\phi} = \frac{-mL}{J + mL^2} \ddot{s} + \frac{mL}{J + mL^2} g \phi \quad (11)$$

Let $L' = \frac{J + mL^2}{mL}$ and consider it to be an "effective pendulum length." The equations of motion are now:

$$\ddot{s} = \frac{-F}{M} \dot{s} + \frac{1}{M} u \quad (12)$$

$$\ddot{\phi} = -\frac{g}{L'} \phi \quad (13)$$

The equations of motion have been significantly simplified through the linearization process. It should be noted however, that the actual physical inverted pendulum must operate within a narrow limit of pendulum angle, be constructed

with very little real friction, and use a light weight, slender pendulum rod to actually behave as the mathematical model predicts.

B. DETERMINATION OF SYSTEM PHYSICAL CONSTANTS

In designing the cart, values needed to be determined for all the coefficients in equations of motion (12) and (13), for meaningful computer simulation to take place and for design of the actual controller. Initial computer work was conducted using "ballpark" values to get a feel for how the system would react when stabilized with various control laws applied. The primary unknown value which must be found is F , the viscous friction coefficient of the cart.

From measurements of the actual cart and pendulum, the following data was recorded:

Cart

$$M = 8.45 \text{ lb} = 3.83 \text{ kg}$$

Pendulum

$$m = 12.5 \text{ oz} = 0.354 \text{ kg}$$

$$\lambda = 40 \text{ in} = 1.016 \text{ m}$$

$$J = \frac{1}{12} m \lambda^2, \quad L = \lambda/2, \quad L' = \frac{J + mL^2}{mL}$$

therefore,

$$L' = \frac{4}{3} L = 0.677 \text{ m}$$

By rearranging equation (12) one obtains:

$$M \ddot{s} = u - F \dot{s} \quad (14)$$

In this form, the equation may be recognized as Newton's Second Law:

$$m a = \sum \text{Forces}$$

The terms on the right side of equation (14) represent the total force exerted on the cart.

$$f \equiv u - F \dot{s} \quad (15)$$

The force exerted on the cart by the motor and gear train through the drive wheels, u , is simply a linear function of the voltage applied to the motor. Therefore one can define

$$u \equiv f_v V \quad (16)$$

where f_v is an applied voltage force (proportionality) constant and V is the voltage applied to the motor. Now,

$$f = f_v V - F \dot{s} \quad (17)$$

In order to determine values for f_v and F , it was necessary to eliminate selectively one of the two terms from equation (17).

With the cart restrained from moving, a voltage was applied to the motor until the wheels started to slip. The force

exerted by the cart was measured using a Catilian Force Gauge. With no motion, $\dot{s} = 0$ and $f = f_v V$ or,

$$f_v = \frac{f}{V} . \quad (18)$$

A series of test runs was performed which yielded an average applied voltage force coefficient of

$$\bar{f}_v = 0.2762 \text{ lbf/volt} = 1.2285 \text{ newton/volt} .$$

Rearranging equation (14) and including the new definition of u results in

$$F = \frac{f_v V}{\dot{s}} - \frac{M \ddot{s}}{\dot{s}} \quad (19)$$

Values for average velocity \dot{s} , and average acceleration \ddot{s} must now be determined using a specific voltage to drive the motor so that a value for F can be determined.

The pendulum was replaced with an equivalent mass of steel. The cart was run on the floor to observe motor tachometer and wheel potentiometer output on a brush recorder as a function of time as the cart accelerated from rest. A constant voltage of 15 volts was applied to the motor.

Using the wheel potentiometer recorded output (voltage vs. time), the potentiometer's measured characteristics (degrees vs. voltage) (from Appendix A), and the physical size of gears and wheel, the average velocity was determined to be

$$\dot{s} = \bar{v} = \frac{\Delta x}{\Delta t} = .4128 \text{ meters/sec} \quad (20)$$

Using a similar method, the output from the motor tachometer versus time was converted to an average acceleration of:

$$\ddot{s} = \bar{a} = \frac{\Delta v}{\Delta t} = 1.275 \text{ meters/sec}^2 . \quad (21)$$

Now using equation (19), one may solve for F.

$$F = 32.922 \text{ kg/sec}$$

The equations of motion with physical values included are:

$$\ddot{s} = -9.589 \dot{s} + .261 u \quad (22)$$

$$\ddot{\phi} = -1.477 \dot{s} + 14.486 \phi \quad (23)$$

These values are within a factor of 5 of the values obtained in Reference 2 and within a factor of 8 of the value used in Reference 1.

In order to more easily manipulate the equations for the inverted pendulum, it will be convenient to express them in state variable notation. Straight forward checks for controllability and observability are available using state variable methods.

C. STATE VARIABLE FORMULATION

Intuitively one recognizes that with no forces applied except gravity, the inverted pendulum is unstable. When the pendulum shaft is balanced in a vertical position with the

pivot at the bottom of the shaft, the slightest perturbation will cause the pendulum to tumble.

In general, any system may be checked for stability by looking at the roots of the characteristic polynomial, $\det[SI-A] = 0$, where the system equations are in the state variable form $\dot{\underline{x}} = [A]\underline{x} + [B]\underline{u}$. For a stable system, all characteristic roots will lie in the left-half (negative) complex plane. Any roots lying in the right-half complex plane are considered unstable poles and lead to an unstable system.

The inverted pendulum system equations of motion may be put into state variable form by defining the following states [Reference 1]:

$$x_1 = s(t) \quad (24)$$

$$x_2 = \dot{s}(t) \quad (25)$$

$$x_3 = s(t) + L'\phi(t) \quad (26)$$

$$x_4 = \dot{s}(t) + L'\dot{\phi}(t) \quad (27)$$

where,

x_1 is displacement of the cart,

x_2 is velocity of the cart,

x_3 is a linearized approximation of the displacement of a point on the pendulum at a distance L' from the pivot. It can be considered as the displacement of the pendulum,

x_4 is the linearized approximation of the velocity of the pendulum at the same point as made up x_3 .

Therefore,

$$\dot{x}_1 = x_2 \quad (28)$$

$$\dot{x}_2 = \frac{-F}{M} x_2 + \frac{1}{M} u \quad (29)$$

$$\dot{x}_3 = x_4 \quad (30)$$

$$\dot{x}_4 = \frac{-g}{L'} x_1 + \frac{g}{L'} x_3 \quad (31)$$

The matrix representation of these state equations is:

$$\dot{\underline{x}} = \begin{bmatrix} 0 & 1 & 0 & 0 \\ 0 & \frac{-F}{M} & 0 & 0 \\ 0 & 0 & 0 & 1 \\ \frac{-g}{L'} & 0 & \frac{g}{L'} & 0 \end{bmatrix} \underline{x} + \begin{bmatrix} 0 \\ \frac{1}{M} \\ 0 \\ 0 \end{bmatrix} u \quad (32)$$

D. DETERMINATION OF STABILITY

The characteristic equation of $\dot{\underline{x}} = [A]\underline{x} + [B]u$ comes from $\det[SI-A] = 0$,

$$[SI-A] = \begin{bmatrix} S & -1 & 0 & 0 \\ 0 & S + \frac{F}{M} & 0 & 0 \\ 0 & 0 & S & -1 \\ \frac{g}{L'} & 0 & \frac{-g}{L'} & S \end{bmatrix} \quad (33)$$

$$\det[SI-A] = S(S^3 + \frac{F}{M} S^2 - \frac{g}{L'} S - \frac{Fg}{L'M}) = 0 \quad (34)$$

The roots of the characteristic equation give the eigenvalues of the system:

$$s_1 = 0, \quad s_2 = \frac{-F}{M}, \quad s_3 = -\sqrt{g/L'}, \quad s_4 = \sqrt{g/L'}$$

Using the physical values as determined for the actual system, the eigenvalues become:

$$s_1 = 0, \quad s_2 = -8.589, \quad s_3 = -3.806, \quad s_4 = 3.806$$

The eigenvalues s_2 and s_3 are negative, therefore stable poles. Eigenvalue s_1 is considered neutrally stable, and s_4 is an unstable pole.

One of the objects of this thesis was to stabilize the unstable system using a suitable control law, so controllability of the system must be determined.

E. CONTROLLABILITY

To solve control problems, such as the inverted pendulum, it is important to know if the system has the property that it may be moved from any given initial state to any other given state in a finite period of time. Controllability implies the ability to move the poles of a system from some starting position to any arbitrary place in the left-half complex plane.

A theorem on controllability (Reference 1) states that:

The n-dimensional linear time-invariant system

$$\dot{\underline{x}} = [A]\underline{x} + [B]\underline{u}$$

is completely controllable if and only if the column vectors of the controllability matrix

$$\underline{P} = [\underline{B}, \underline{AB}, \underline{A^2B}, \dots, \underline{A^{n-1}B}] \quad (35)$$

span the n-dimensional space.

A matrix spans the n-dimensional space and is therefore controllable if

$$\det[P] \neq 0 .$$

Using the system numerical values, the state matrix equation is:

$$\dot{\underline{x}} = \begin{bmatrix} 0 & 1 & 0 & 0 \\ 0 & -8.589 & 0 & 0 \\ 0 & 0 & 0 & 1 \\ -14.486 & 0 & 14.486 & 0 \end{bmatrix} \underline{x} + \begin{bmatrix} 0 \\ .261 \\ 0 \\ 0 \end{bmatrix} u \quad (36)$$

$$\underline{P} = \begin{bmatrix} 0 & 0.261 & -2.242 & 19.254 \\ 0.261 & -2.242 & 19.254 & -165.374 \\ 0 & 0 & 0 & -3.781 \\ 0 & 0 & -3.781 & 32.474 \end{bmatrix} \quad (37)$$

$$\det[P] = 0.974$$

Therefore, the inverted pendulum system is controllable.

Although a system may be completely controllable, there may be times when all states of the system may not be available

for measurement. In order to find a control law which stabilizes a particular system which has unmeasurable state variables, one is led to the concept of observability. Knowledge of where the system is must be available before the system can be controlled.

F. OBSERVABILITY

The concept of observability is based on an ability to observe the output vector of a system.

$$\underline{y} = [C]\underline{x} + [D]\underline{u} \quad (38)$$

A system is said to be completely observable if every initial state $\underline{x}(0)$ can be determined from the observation of $\underline{y}(t)$ over a finite time interval.

A theorem on Observability (Reference 1) states that the n-dimensional, linear time-invariant system

$$\begin{aligned} \dot{\underline{x}} &= [A]\underline{x} + [B]\underline{u} \\ \underline{y} &= [C]\underline{x} \end{aligned} \quad (39)$$

is completely observable if and only if the row vectors of the observability matrix

$$\underline{Q} = \begin{bmatrix} C \\ CA \\ CA^2 \\ \vdots \\ CA^{n-1} \end{bmatrix} \quad (40)$$

span the n-dimensional space. The matrix spans the n-dimensional space if $\det[Q] \neq 0$.

With the fourth order system under consideration there are 15 possible output combinations for the vector [C].

When the output vector is made up of states x_1 and x_3 for example, $\underline{y} = [1 \ 1 \ 1 \ 0] \underline{x}$ and:

$$\underline{Q} = \begin{bmatrix} 1 & 0 & 1 & 0 \\ 0 & 1 & 0 & 1 \\ -14.486 & -8.589 & 14.486 & 0 \\ 0 & 59.285 & 0 & 14.486 \end{bmatrix} \quad (41)$$

$$\det[Q] = -1297.917$$

Therefore the inverted pendulum is observable for the output $\underline{y} = [1 \ 0 \ 1 \ 0] \underline{x}$.

Observability of the system for all output combinations of [C] is as follows:

Observable

Not Observable

[0 0 1 0]

[0 0 0 1]

[0 0 1 1]

[0 1 0 0]

[0 1 1 0]

[0 1 0 1]

[0 1 1 1]

[1 0 0 0]

[1 0 0 1]

[1 1 0 0]

[1 0 1 0]

[1 0 1 1]

[1 1 0 1]

[1 1 1 0]

[1 1 1 1]

With the conditions of controllability and observability known for the system, the analysis and design of a linear control law for stabilizing the inverted pendulum may proceed.

III. STATE VARIABLE FEEDBACK

A. STATE VARIABLE FEEDBACK CONTROL INTRODUCTION

A control system is a dynamic system which, over a period of time, behaves in a manner prescribed by the control law which describes the control system. In the case of an automatic control system, human input is not required and may not be desired.

The primary sections of a control system are: the plant, which is the system to be controlled; one or more sensors to provide information about the system; and a controller which compares measured values to desired values and changes plant inputs accordingly to arrive at the proper output.

One of the functions of the controller is to move the poles of the plant to locations in the left-half complex plane so that performance of the system may be improved. When the plant by itself is unstable, the main function of the controller is to stabilize the system by moving the closed-loop poles to proper locations in the left-half plane.

A feedback control system is one which attempts to maintain a set relationship between the output and some reference input by comparing them and using the difference signal as a means of control.

State variable feedback is particularly convenient because the state \underline{x} contains all pertinent information about the system. The basic restraint placed on the analysis in this section

is that the complete state of the plant can be measured accurately at all times and is available for feedback.

For a linear time-invariant system such as $\dot{\underline{x}} = [A]\underline{x} + [B]\underline{u}$, a time-invariant control law which applies is:

$$\underline{u} = -[K]\underline{x} + \underline{u}' \quad (42)$$

where $[K]$ is the feedback matrix and \underline{u}' is some input such as from a human operator. In the inverted pendulum system \underline{u}' is ignored.

The control law

$$\underline{u} = -K_1x_1 - K_2x_2 - K_3x_3 - K_4x_4 \quad (43)$$

applies for a fourth order system.

Substitution of this control law into the system state matrix (32) yields:

$$\dot{\underline{x}} = \begin{bmatrix} 0 & 1 & 0 & 0 \\ \frac{-K_1}{M} & \frac{-K_2}{M} - \frac{F}{M} & \frac{-K_3}{M} & \frac{-K_4}{M} \\ 0 & 0 & 0 & 1 \\ \frac{-g}{L'} & 0 & \frac{g}{L'} & 0 \end{bmatrix} \underline{x} \quad (44)$$

or

$$\dot{\underline{x}} = [A - KB]\underline{x} = [A_{aug}]\underline{x} \quad (45)$$

The characteristic polynomial comes from $\det[SI - A_{aug}] = 0$

or:

$$s^4 + \left(\frac{K_2 + F}{M}\right)s^3 + \left(\frac{K_1}{M} - \frac{g}{L^*}\right)s^2 + \frac{g}{L^*M}(-K_4 - K_2 - F)s + \frac{g}{L^*M}(-K_1 - K_3) = 0 \quad (46)$$

With system numerical values included, the equation becomes:

$$s^4 + (.261 K_2 + 8.589)s^3 + (.261 K_1 - 14.486)s^2 + 3.782(-K_4 - K_2 - 32.922)s + 3.782(-K_1 - K_3) = 0 \quad (47)$$

With proper selection of feedback gains one may arbitrarily assign pole locations to stabilize a system or to simply improve its performance.

B. FULL STATE VARIABLE FEEDBACK CONTROL

Another method for determining feedback coefficients for a time-invariant control law involves the use of "engineering judgment" to place the poles of the closed-loop system in the left-half complex plane at a position of one's choice. By choosing the poles far to the left in the complex plane, the convergence to the zero state can be made arbitrarily fast. To make the system move fast however, requires large input

amplitudes, and in an actual physical system, there is a limit as to how large the input can be.

Assume it is desired that the poles be placed at

$$s = -3, \quad s = -3 \quad \text{and} \quad s = -3 \pm j3.$$

The desired characteristic equation is then

$$s^4 + 12 s^3 + 63 s^2 + 162 s + 162 = 0 . \quad (48)$$

The control law which applies in this case is the same as for the general state variable feedback case

$$u = -K_1 x_1 - K_2 x_2 - K_3 x_3 - K_4 x_4 .$$

Again for the system to be stable, each coefficient of the characteristic equation must be positive. Equating coefficients of the augmented characteristic equation (47) and the desired characteristic equation (48) yields the proper feedback coefficients for pole placement

$$\begin{aligned} K_1 &= 296.9 \\ K_2 &= 13.069 \\ K_3 &= -339.73 \\ K_4 &= -88.825 . \end{aligned}$$

Computer simulation using the Interactive Ordinary Differential Equation Solver (IODE) on the Naval Postgraduate School IBM 370 shows that pendulum stabilization to a displacement of

.007 meters in 2 seconds should take place from an initial condition of .0667 meters (.1 radians) of pendulum angle. (See Appendix B for simulation results.)

Figure 2 is a block diagram representing the unstable plant of the inverted pendulum and the state variable feedback controller which stabilizes it.

Full state variable feedback has been shown to work well for a system with all states accurately measured.

The actual cart does not respond in the same manner as the simulations would predict because the cart is receiving a continuous input from all of the sensors instead of a single initial disturbance. As might be expected, once the actual pendulum system motion is started, the pendulum angle oscillates on either side of zero.

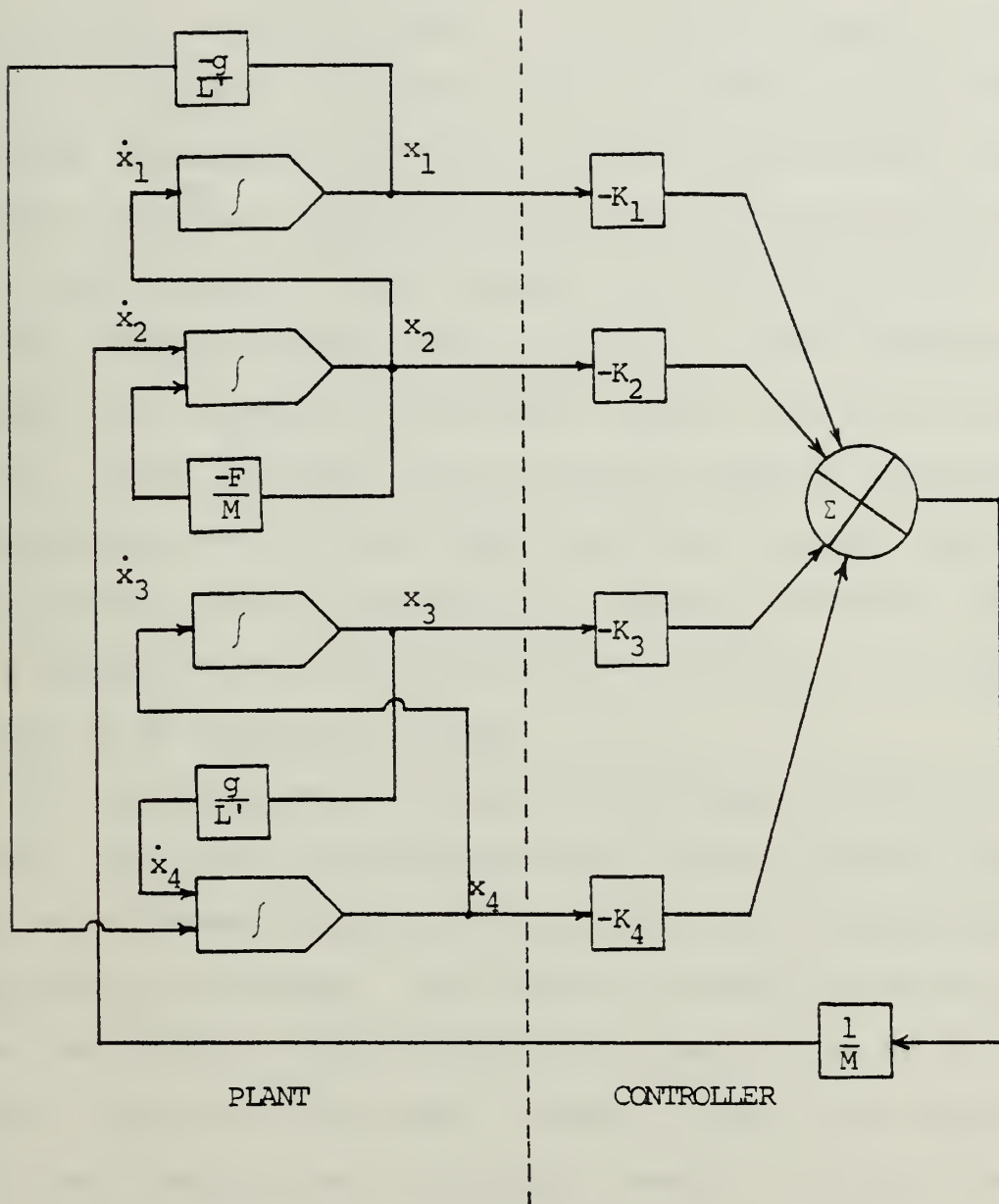

Figure 2. FULL STATE VARIABLE FEEDBACK CONTROL SYSTEM

IV. CONSTRUCTION OF INVERTED PENDULUM MODEL

Building a working model of the inverted pendulum for this thesis was quite a challenge. Little technical data could be obtained concerning construction of any previous cart and pendulum systems, therefore design ideas came from line drawings, photographs of other systems, and basic intuition.

As a starting point, the system was to be portable for viewing in a classroom environment rather than as a laboratory setup. Large equipment such as analog computer and heavy power supply could not be used, therefore a solid state power supply and controller were built. Target weight for the cart assembly was arbitrarily set at 6 pounds, and a pendulum length of 40 inches was chosen.

The motor/generator, pendulum tachometer, pendulum potentiometer, and wheel potentiometer were chosen primarily because they were already available within the N.P.S. Aeronautical Engineering Department. The physical dimensions of the cart came about simply from the physical sizes of the motor and sensor components to be used. Rubber wheels were chosen to give good traction and to minimize damage to table or bench tops when the cart was demonstrated. A power supply and control circuit (covered later) were housed in a small carrying case and an umbilical cord was used to supply power and control signals to the cart and receive sensor feedback from the cart and pendulum.

Photographs of the cart assembly and control box are in figures 3 through 6.

Testing and measurement of the tachometers and potentiometers was carried out in the Aeronautical Engineering Electronics Laboratory. Calculations, tables, and plots of the sensor constants are contained in Appendix A.

A full state variable feedback control law was developed in Section III which placed the closed-loop poles at

$$s = -3, \quad s = -3, \quad s = -3 \pm j3.$$

The control law was

$$u = -K_1x_1 - K_2x_2 - K_3x_3 - K_4x_4 \quad (49)$$

where

$$K_1 = 296.90$$

$$K_2 = 13.07$$

$$K_3 = -339.73$$

$$K_4 = -88.83$$

Recall that

$$x_1 = s$$

$$s = \text{cart position}$$

$$x_2 = \dot{s}$$

$$\dot{s} = \text{cart velocity}$$

$$x_3 = s + L'$$

$$\phi = \text{pendulum position}$$

$$x_4 = \dot{s} + L'\dot{\phi}$$

$$\dot{\phi} = \text{pendulum velocity}$$

$$L' = 0.677 \text{ m}$$

$$L' = \text{effective pendulum length.}$$

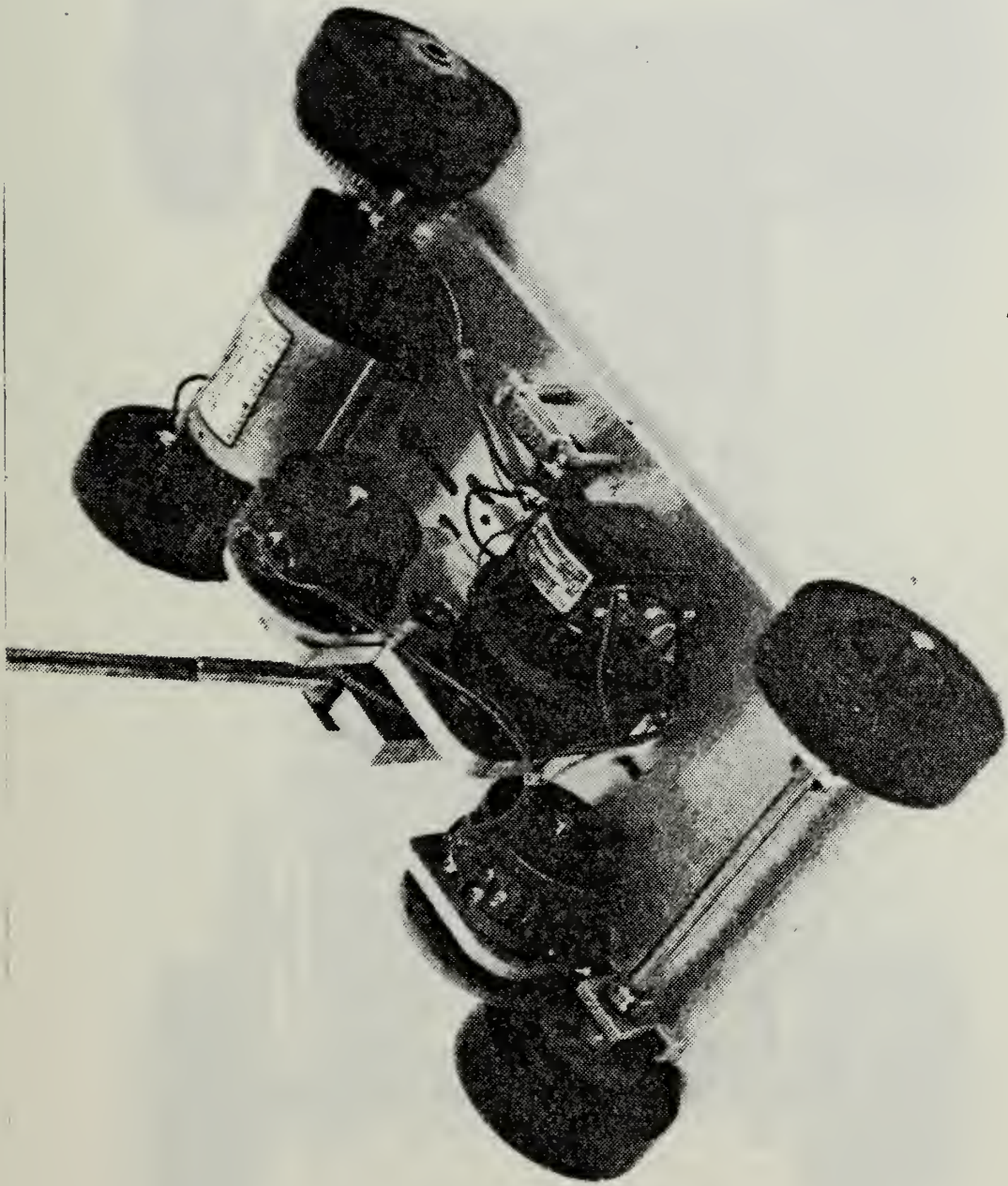

Figure 3. CART QUARTER VIEW

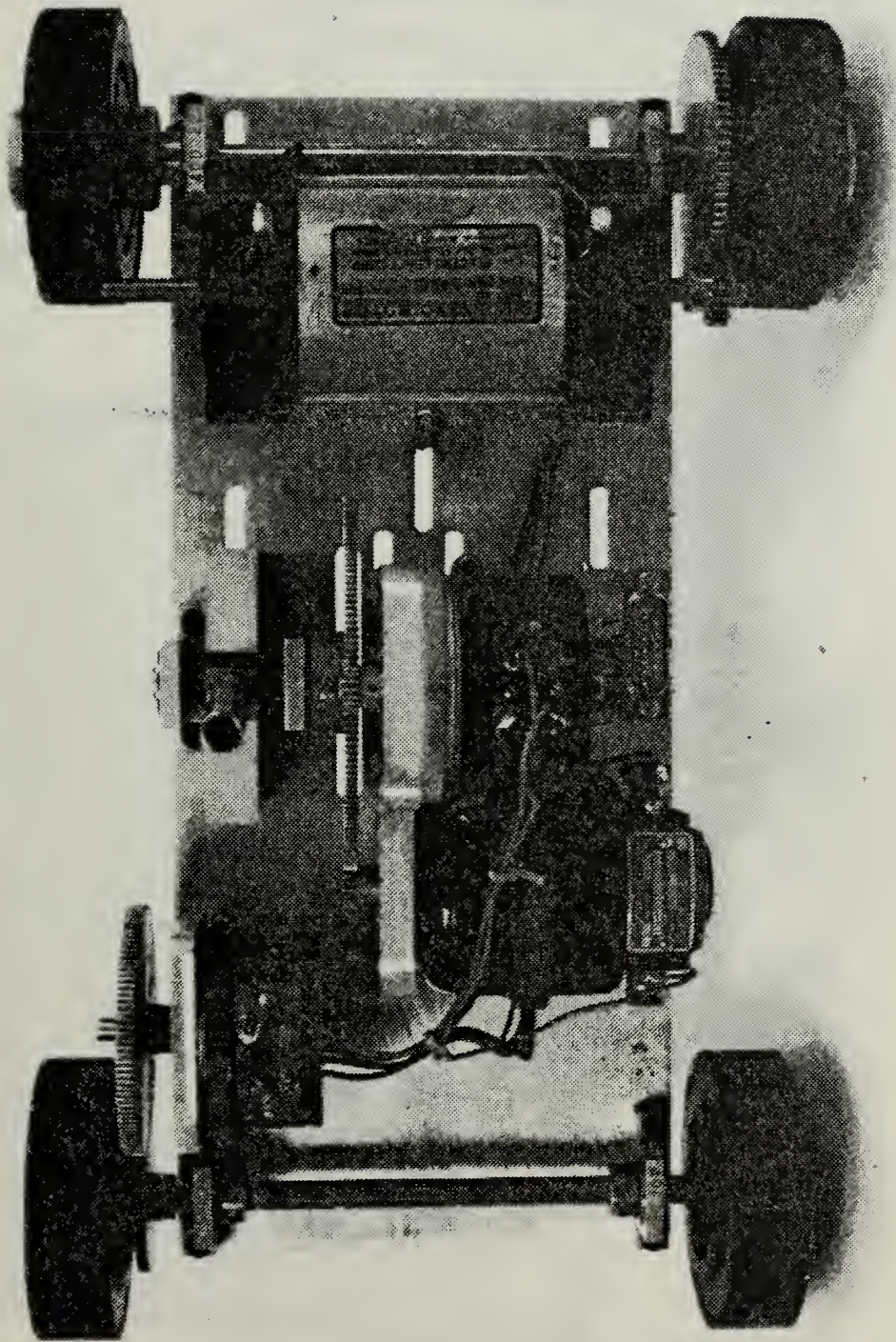

Figure 4. CART TOP VIEW

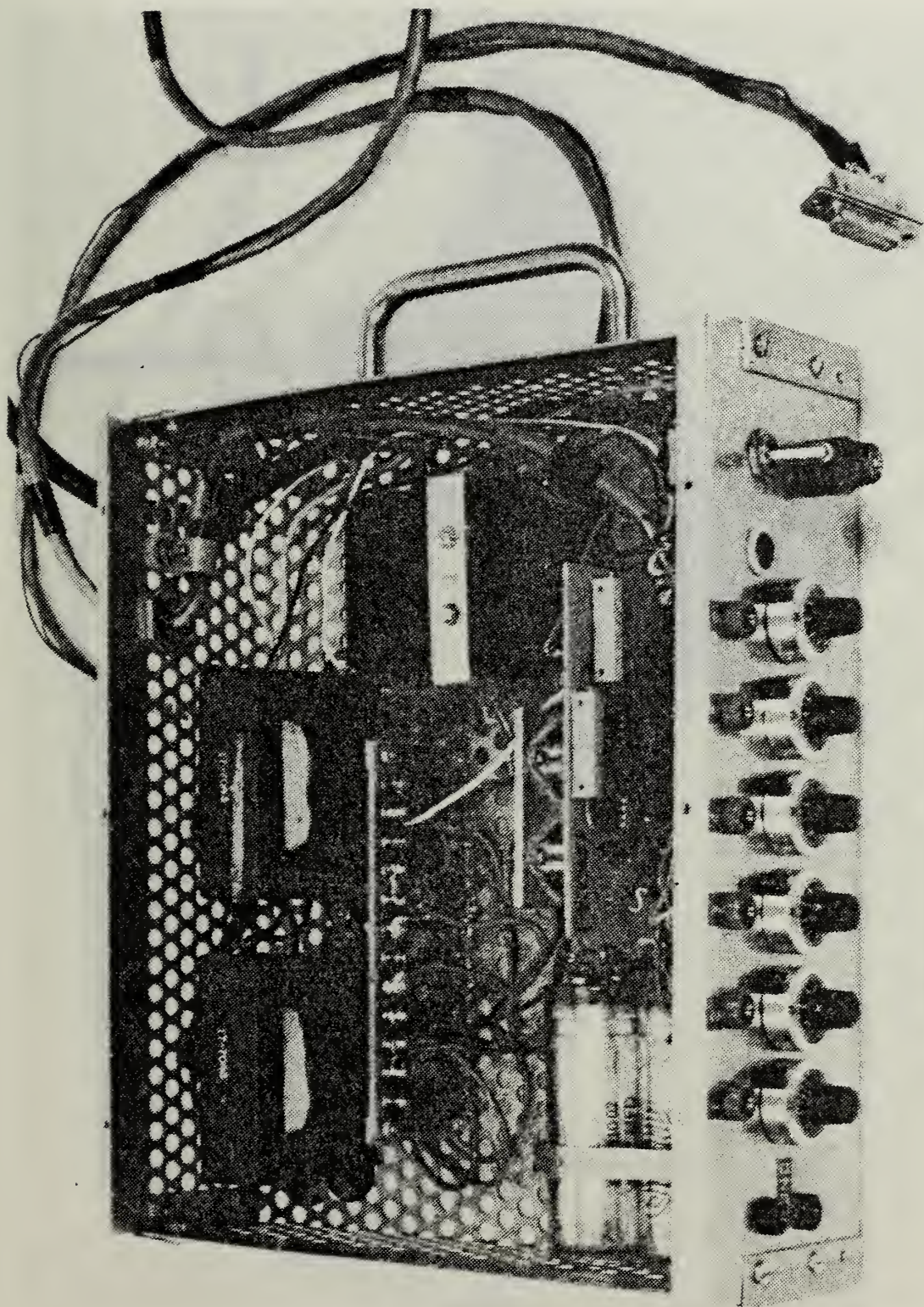

Figure 5. CONTROLLER/POWER SUPPLY--INSIDE VIEW

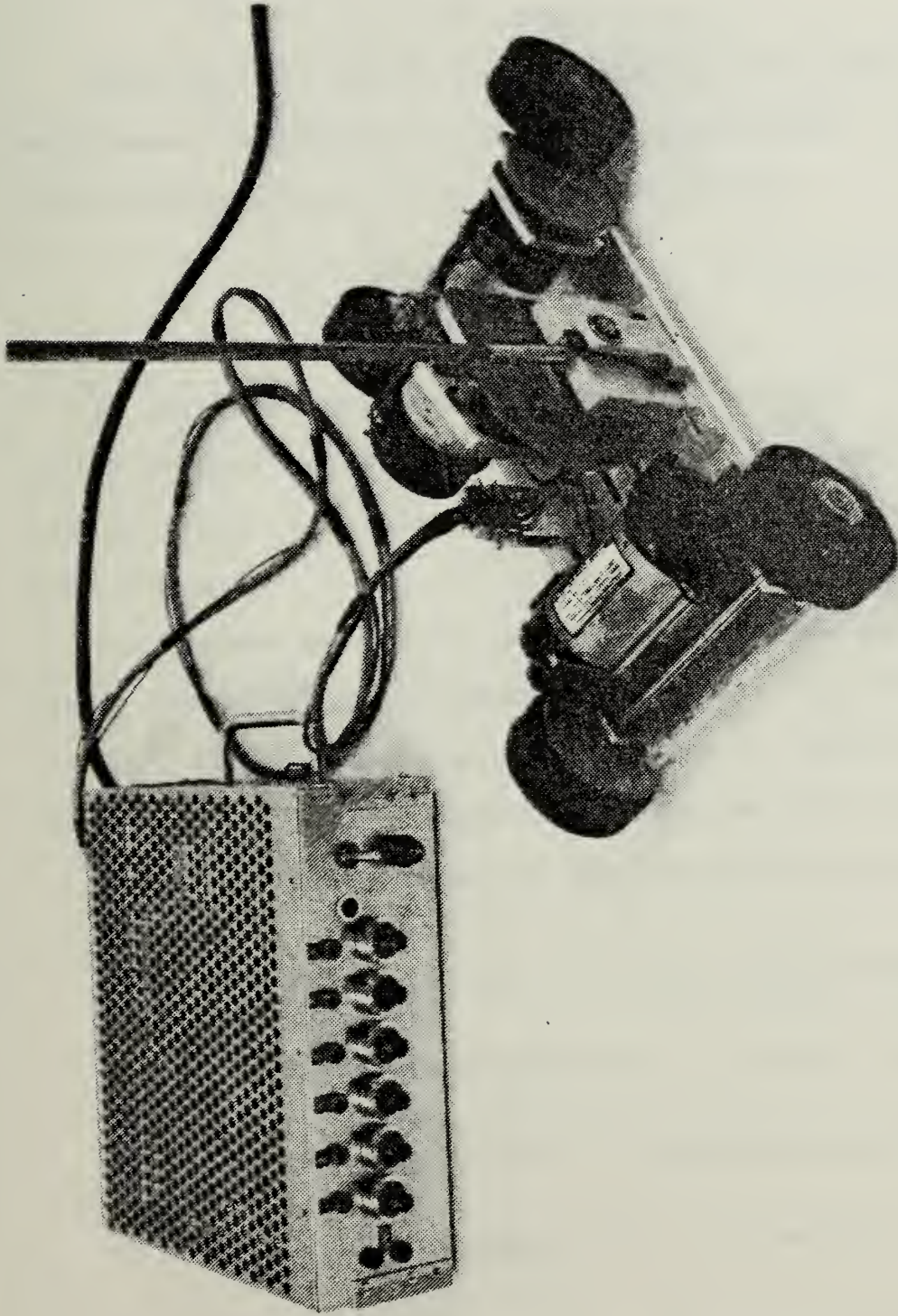

Figure 6. INVERTED PENDULUM SYSTEM DEMONSTRATION SETUP

Substitute state definitions into equation (49) to get

$$u = (-K_1 - K_3)S + (-K_2 - K_4)\dot{S} - K_3L'\phi - K_4L'\dot{\phi} . \quad (50)$$

Equation (50) is the control law as referenced to the measurement variables of the system constructed. With the gain constants substituted, equation (50) is

$$u = 42.83 S + 75.76 \dot{S} + 230.0 \phi + 60.14 \dot{\phi} . (51)$$

In order to implement the control law, each of the measured variables must be referenced to a common base, amplified appropriately, and summed with the other variables to produce the control.

From Appendix A, each sensor was measured, and a constant was developed which references each sensor to a base level of 1 volt. In the measurements, the range of operation of each sensor was taken into account in weighting the constant.

The final values obtained for the sensors used were:

$$K_w = .1734 \text{ meters/volt --- wheel potentiometer (S)}$$

$$K_m = .2012 \text{ meters/second-volt. --- motor tachometer (\dot{S})}$$

$$K_p = 1.1073 \text{ radians/volt --- pendulum potentiometer (\phi)}$$

$$K_T = 9.39 \text{ radians/second-volt. --- pendulum tachometer(\dot{\phi})}$$

An additional potentiometer was included in each sensor input circuit which acts as a voltage divider. The voltage

divider actions provide signals from each sensor which are of the proper magnitude before being amplified and summed for the control law.

The sensor calibration constants must be applied to the control law to realize a properly proportioned electronic controller.

$$u = K_w(-K_1-K_3)S + K_m(-K_2-K_4)\dot{S} - K_p K_3 L' \phi - K_t K_4 L' \dot{\phi} \quad (52)$$

or for the system desired,

$$u = K_w(42.85)S + K_m(75.76)\dot{S} + K_p(230.0)\phi + K_t(60.14)\dot{\phi} \quad (53)$$

and finally, after substitution of actual sensor constants

$$u = 7.43 S + 15.24 \dot{S} + 254.68 \phi + 564.66 \dot{\phi} \quad (54)$$

Implementation of the controller using operational amplifiers and power transistors is shown in figure 7.

Each front panel potentiometer has a range scale from 0 to 10 using a calibrated dial.

The gain adjustment potentiometers size the measured variables as follows:

Potentiometer one	S
Potentiometer two	\dot{S}
Potentiometer three	ϕ
Potentiometer four	$\dot{\phi}$

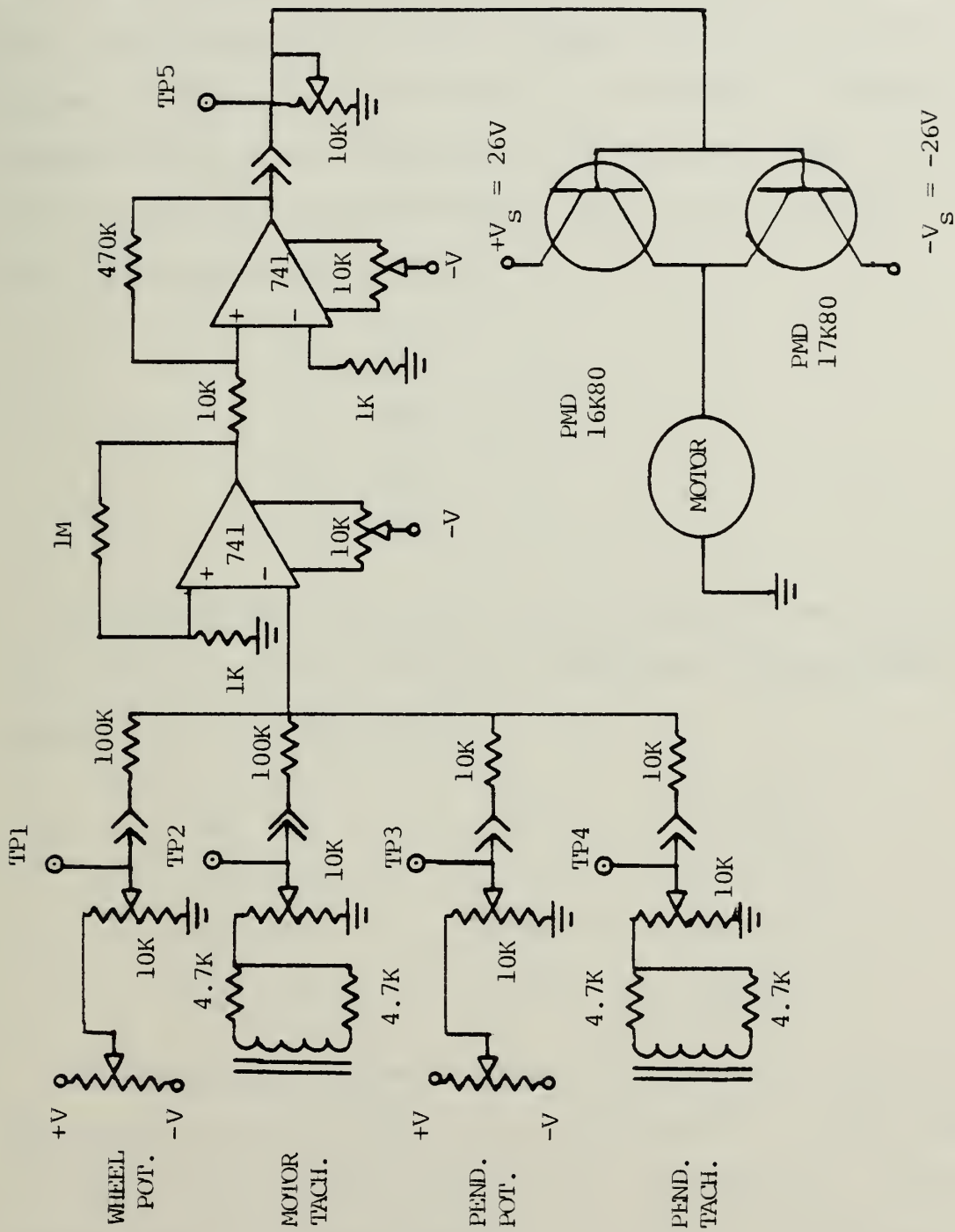

Figure 7. CONTROLLER CIRCUITRY

The actual controller circuitry provides an additional amplification to supplement the voltage division of the gain adjustment potentiometers. An infinite number of pole placement positions are available through variations in the state variable feedback gain constants K_1 through K_4 , and can be implemented with the constructed controller. The only limitation is on the maximum coefficient values in equation (54). The values which may be used are:

0	to	100	S
0	to	100	\dot{S}
0	to	1000	ϕ
0	to	1000	$\dot{\phi}$

To set up the controller for the control law of equation (54) dial in the following gain adjustment potentiometer settings on the control box.

pot #1	.74	(7.43 S)
pot #2	1.52	(15.24 \dot{S})
pot #3	2.55	(254.68 ϕ)
pot #4	5.65	(564.66 $\dot{\phi}$)

Potentiometer number 5 adjusts the overall magnitude of the output voltage to the cart drive motor. It was found that a value of 5.0 on that potentiometer worked well. Potentiometer number 6 is not used at this time but was installed for future expansion.

By experiment, the cart works best with the following settings:

pot #1	5.5
pot #2	0 (or a small value)
pot #3	10
pot #4	10
pot #5	5.0

The inverted pendulum system as constructed does not work as well as hoped. Ability to closely control the cart's position has thus far been unsuccessful. The cart's region of motion spans approximately 8 to 12 inches of horizontal cart travel. Cart position oscillates on either side of a zero location with an increasing divergence and an increase in the signal from the wheel potentiometer only causes the system to go unstable more rapidly. When values above zero are input from the motor tachometer, the cart motion becomes more sluggish. Best cart performance and longest stability is achieved with the motor tachometer output grounded (potentiometer set to zero). The controller noticeably attempts to correct the cart position after it has travelled 4 to 6 inches from center, however, the motor inputs are somewhat large, and after the cart moves 8 to 10 inches from center, the motor response appears to be too large and the pendulum swings out of the stable range and topples. At this time there is not a full understanding of the problem with cart velocity.

The range of operable pendulum angle is small. In order to have the system work, one must help the pendulum achieve a small stable oscillation before letting the system to on its own. The system operates for 10 to 15 seconds then goes unstable with larger and larger movements in both cart and pendulum. This observation can only lead to the conclusion that the system is only neutrally or marginally stable at best. Because the motion of the cart seems to be driving the pendulum unstable, it is possible that the pendulum poles are adequately positioned on the left-half complex plane and the cart poles are on the axis or even in the right-half plane.

There is a sizeable amount of real friction in the pendulum mount from bearings, potentiometer and tachometer drag which have been ignored in the development of the controller, but which possibly contribute to the instability of the system.

Some recommendations for areas of possible improvement are covered in the final section of this paper.

V. CONCLUSIONS AND RECOMMENDATIONS

A. CONCLUSIONS

The purpose of this paper was to design an inverted pendulum which could be used to compare theory with experimental results. In that sense, the purpose was not met.

Equations of motion were developed for the inverted pendulum and converted into state variable form. State variable feedback was selected as a basis for control of the actual system constructed. In order to reduce the complexity of the system for control analysis, the equations of motion were linearized. Friction in the pendulum pivot was ignored, but in the actual system, friction was definitely present.

Friction possibly added damping to the system so that the pendulum fell more slowly, however, it would have also forced the cart to make larger and longer duration corrections to return the pendulum to a vertical position.

The size of the cart drive motor along with the traction of the drive wheels could possibly be the cause of the system's inability to become stable.

It was assumed that the dynamic response of the motor and its electronic circuit was sufficiently fast to be considered instantaneous; that switching from forward to reverse rotation was done without delay.

It is speculated that the actual motor and gear drive reached their acceleration limits when trying to catch a

pendulum angle much above ± 5 degrees. The motor simply could not accelerate the cart fast enough to catch the pendulum.

B. RECOMMENDATIONS

The following list includes several possible ways to improve the physical system.

1. Reduce friction in the pendulum pivot by: using a small, low friction, high precision potentiometer or magnetic pickup device to sense pendulum angle; replacing the permanent magnet pendulum tachometer with a magnetic drag-cup tachometer or with a micro-lightweight accelerometer attached to the pendulum at its center-of-gravity or tip.

2. Purchase a high quality motor/tachometer assembly for driving the cart. Choose a motor with a torque output in the 50 to 100 ounce-inch range and be certain that all constants are available for the new motor and tachometer so that a full analysis may be made using the appropriate constants.

3. Install tires which are at least twice as wide and perhaps twice as tall as those now used to provide more contact area for improved traction.

4. Analyze the system using sensor and motor constants (if available), gear ratios, moments of inertia of all rotating parts and friction.

5. Study the effects of measurement errors, system disturbances and noise on observers along with optimal methods for selection of gain matrices for pole placement.

6. Implement cart controllers using full-order and reduced-order observers to drive the controller.
7. Study the effects on stability of using slightly flexible pendulums and pendulums of various lengths.
8. Study the possibility of implementing the control system digitally using a microprocessor chip.

APPENDIX A

SENSOR MEASUREMENTS

Measurements for determination of sensor constants was accomplished using equipment in the Naval Postgraduate School Aeronautical Engineering Department Electronics shop.

- A1. Pendulum potentiometer measurement
- A2. Wheel potentiometer measurement
- A3. Motor tachometer measurement
- A4. Pendulum tachometer measurement

A1. PENDULUM POTENTIOMETER MEASUREMENT

RAW REFERENCE (DEGREES)	ADJUSTED REFERENCE (DEGREES)	VOLTAGE OUTPUT (VOLTS)
28	0	0
30	2	.05
50	22	.73
70	42	1.36
90	62	2.0
110	82	2.63
130	102	3.2
150	122	3.82
170	142	4.5
190	162	5.1
210	182	5.75
230	202	6.4
250	222	7.0
270	242	7.65
290	262	8.3
310	282	8.9
330	302	9.45
355	327	10.0

TABLE 1. PENDULUM POTENTIOMETER MEASUREMENT

From the slope of the measurement curve

$$K = \frac{\text{volts}}{\text{degrees}} = \frac{9V}{285.5^\circ} = .0315 \text{ V/degree} =$$

$$= .9031 \text{ Volts/radian}$$

$$1 \text{ volt corresponds to } \frac{1}{K} = \frac{1}{.9031} = 1.1073 \text{ radians} = K_p$$

For operation on the actual pendulum, the potentiometer was operated at the center of its range with +15V applied to one end and -15V applied to the other end, giving a zero volt reference in the center at 163.5°. Operational range of the potentiometer is indicated on the measurement curve figure 8 and reflects a pendulum angle of ±8 degrees.

A2. WHEEL POTENTIOMETER MEASUREMENT

pot turn number	reference angle (degrees)	voltage output (volts)	pot turn number	reference angle (degrees)	voltage output (volts)
1	0	0	6	0	7.51
	90	.38		90	7.88
	180	.75		180	8.25
	270	1.12		270	8.62
2	0	1.50	7	0	9.00
	90	1.88		90	9.37
	180	2.25		180	9.75
	270	2.63		270	10.12
3	0	3.01	8	0	10.50
	90	3.37		90	10.87
	180	3.76		180	11.25
	270	4.13		270	11.62
4	0	4.51	9	0	12.00
	90	4.89		90	12.38
	180	5.26		180	12.76
	270	5.63		270	13.13
5	0	6.01	10	0	13.50
	90	6.38		90	13.88
	180	6.75		180	14.25
	270	7.12		270	14.63
					360

TABLE 2. WHEEL POTENTIOMETER MEASUREMENT

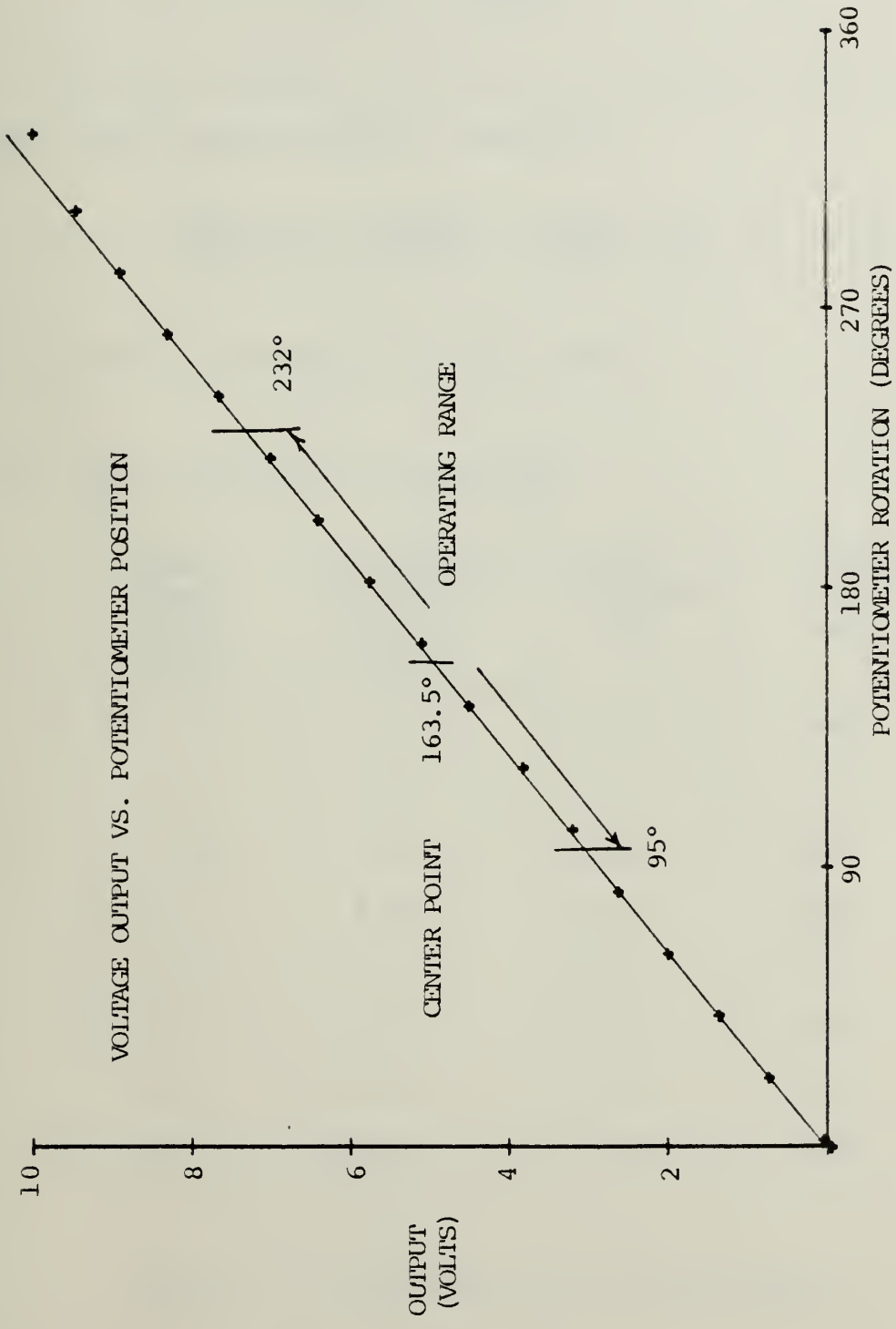

Figure 8. PENDULUM POTENTIOMETER MEASUREMENT CURVE

From the slope of the measurement curve, figure 9:

$$K = \frac{10.5 - 6.01}{720} \frac{\text{volts}}{\text{degrees}} = .0062\text{V/deg}$$

The cart travels 38.7 cm for each revolution of the 10-turn wheel potentiometer, therefore:

$$K_w = \frac{38.7 \text{ cm}}{360 \text{ deg}} * \frac{1 \text{ meter}}{100 \text{ cm}} * \frac{1 \text{ deg}}{.0062 \text{ volt}} = .1734 \text{ m/volt} .$$

1 volt corresponds to .1734 meter.

A3. MOTOR TACHOMETER MEASUREMENT

POWER SUPPLY OUTPUT (VOLTS)	TACHOMETER OUTPUT VOLTAGE (VOLTS)	JAGABI INDICATOR (RPM)	STROBE LIGHT (RPM)
2.5	1.0	410	386
5	3.88	741	815
7.5	6.42	1229	1340
10	8.95	1718	1850
12.5	11.3	2242	2390
15	13.85	2765	2890
17.5	16.4	3226	3420
20	19.0	3772	3920

TABLE 3. MOTOR TACHOMETER MEASUREMENTS

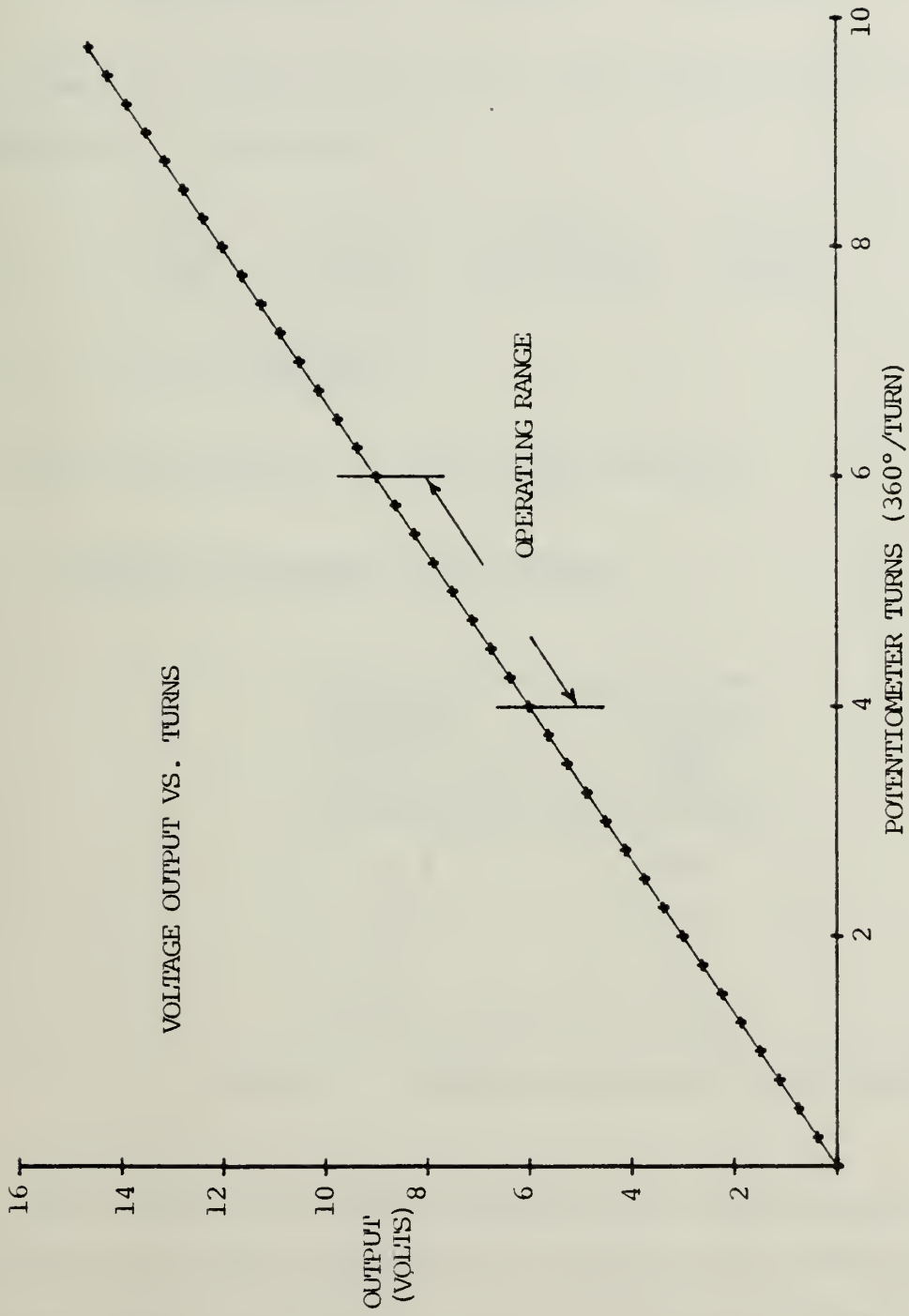

Figure 9. WHEEL POTENTIOMETER MEASUREMENT CURVE

From slope of the measurement curve

$$K = \frac{18 - 2 \text{ V}}{3720 - 430 \text{ RPM}} = \frac{16 \text{ V}}{3320 \text{ RPM}} = \frac{.4819 \text{ V}}{100 \text{ RPM}} = .023 \frac{\text{V-sec}}{\text{rad.}}$$

The cart travels 5.9 cm for each revolution of the motor/tachometer. Therefore

$$K_w = \frac{5.9 \text{ cm}}{\text{Rev}} * \frac{1 \text{ M}}{100 \text{ cm}} * \frac{100 \text{ Rev}}{.4819 \text{ V-min}} * \frac{1 \text{ min}}{60 \text{ Sec}}$$

$$= .2012 \frac{\text{meters}}{\text{volt-sec}}$$

1 volt corresponds to .2012 meters/second.

A4. PENDULUM TACHOMETER MEASUREMENT

Voltage Output (D.C. volts)	Strobe Light (RPM)
4.5	220
19.2	890
35	1600

TABLE 4. PENDULUM TACHOMETER MEASUREMENT

Only three values were obtained for the pendulum tachometer as the only method available for turning the tachometer was using a three speed drill press then measuring RPM with a strobe light.

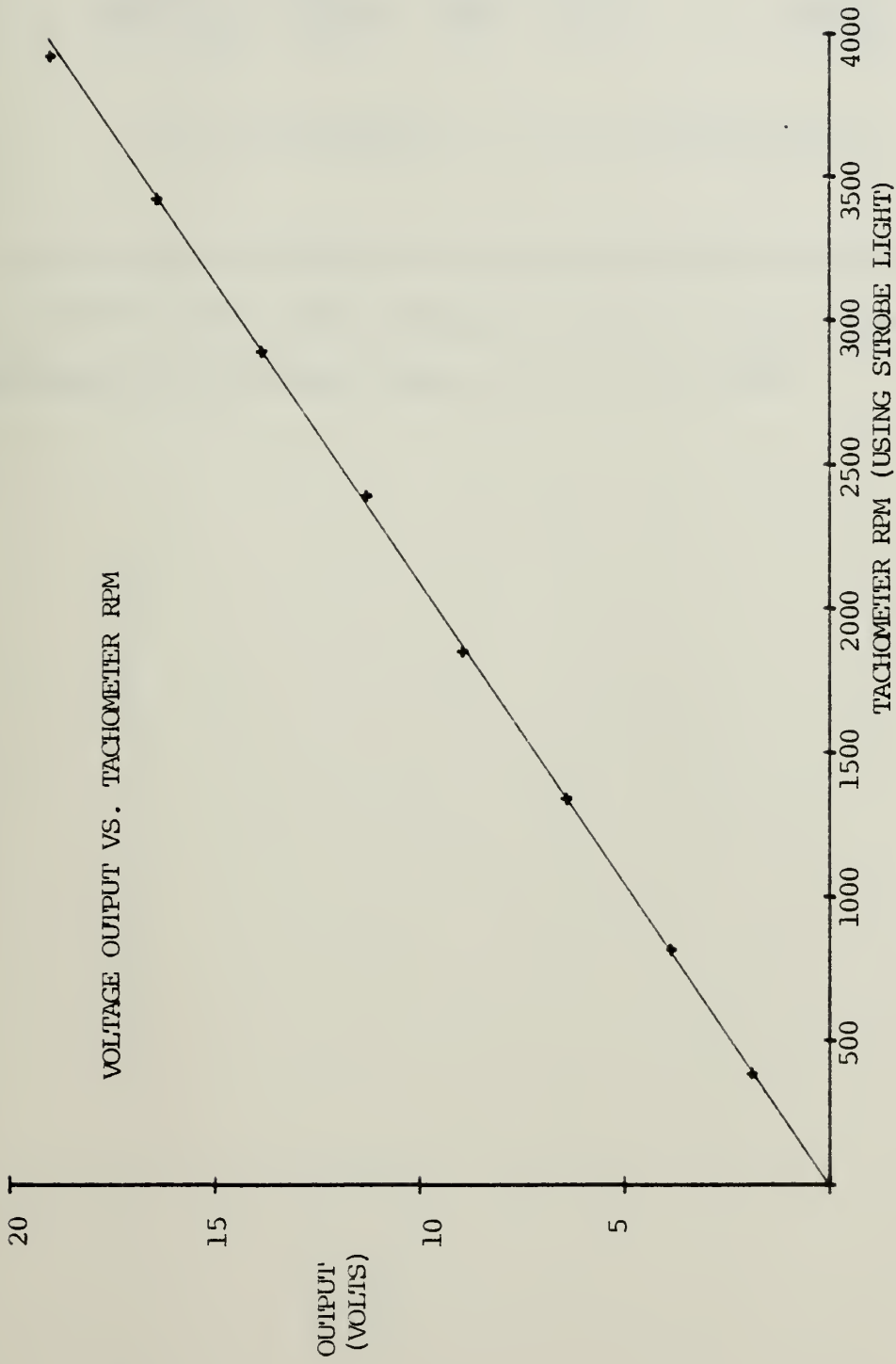

Figure 10. MOTOR TACHOMETER MEASUREMENT CURVE

$$K = \frac{35 - 4.5 \text{ V}}{1600 - 220 \text{ RPM}} = 2.21 \text{ V/100 RPM}$$

$$K_T = \frac{100 \text{ Rev}}{2.21 \text{ V-min}} * \frac{1 \text{ Min}}{60 \text{ Sec}} * \frac{2\pi \text{ Rad}}{180^\circ} * \frac{360^\circ}{\text{Rev}} = 9.39 \frac{\text{radians}}{\text{volt-sec}}$$

1 volt corresponds to 9.39 radians/second

Data plate information on this tachometer specifies a 2.1 volt/100 RPM linear response which is very close to the experimentally derived value of 2.21 V/100 RPM.

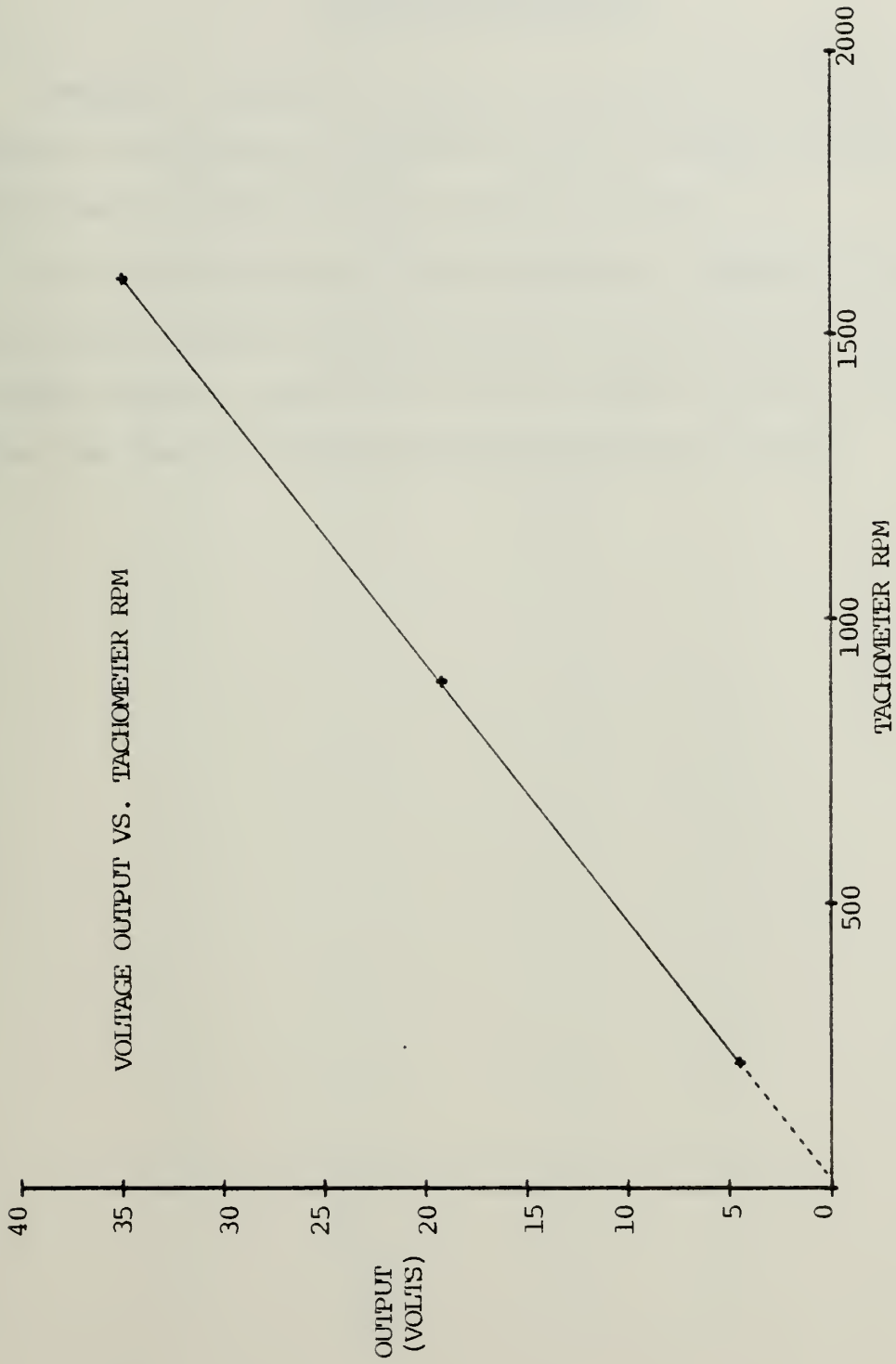

Figure 11. PENDULUM TACHOMETER MEASUREMENT CURVE

APPENDIX B

PROBLEM SIMULATION

Computer simulation was done using the Interactive Ordinary Differential Equation Solver Program (IODE) on the Naval Postgraduate School IBM 370 system.

All simulations use actual physical parameters for the inverted pendulum system which was constructed. Simulations include tabular output as well as french curve fit plots from the Hewlett Packard HP-9830 graphics system.

TABLE 5. STATE VARIABLE FEEDBACK DATA TABLE

T(sec)	x_1 (m)	x_2 (m/sec)	x_3 (m)	x_4 (m/sec)	u(N)
0.00	0.0000	0.0000	0.0677	0.0000	30.0000
0.05	0.0065	0.2429	0.0689	0.0477	22.5300
0.10	0.0227	0.3875	0.0724	0.0886	20.6600
0.15	0.0440	0.4562	0.0776	0.1189	17.8900
0.20	0.0673	0.4684	0.0840	0.1371	14.6100
0.25	0.0902	0.4403	0.0911	0.1433	11.1500
0.30	0.1109	0.3853	0.0982	0.1389	7.7320
0.35	0.1284	0.3143	0.1048	0.1256	4.5250
0.40	0.1422	0.2359	0.1106	0.1054	1.6400
0.45	0.1520	0.1564	0.1153	0.0805	-0.8582
0.50	0.1579	0.0805	0.1186	0.0528	-2.9400
0.55	0.1602	0.0114	0.1206	0.0241	-4.6040
0.60	0.1592	-0.0490	0.1211	-0.0041	-5.8670
0.65	0.1554	-0.0995	0.1202	-0.0308	-6.7590
0.70	0.1494	-0.1399	0.1180	-0.0550	-7.3230
0.75	0.1416	-0.1706	0.1147	-0.0761	-7.6010
0.80	0.1325	-0.1921	0.1105	-0.0938	-7.6410
0.85	0.1225	-0.2054	0.1054	-0.1080	-7.4880
0.90	0.1121	-0.2115	0.0997	-0.1187	-7.1850
1.00	0.0910	-0.2068	0.0872	-0.1303	-6.2790
1.10	0.0712	-0.1867	0.0740	-0.1308	-5.1790
1.20	0.0539	-0.1586	0.0613	-0.1232	-4.0670
1.30	0.0396	-0.1281	0.0496	-0.1105	-3.0560
1.40	0.0283	-0.0990	0.0393	-0.0951	-2.2030
1.50	0.0197	-0.0735	0.0306	-0.0791	-1.5260
1.60	0.0134	-0.0525	0.0234	-0.0639	-1.0160
1.70	0.0090	-0.0362	0.0177	-0.0503	-0.6502
1.80	0.0060	-0.0241	0.0133	-0.0387	-0.4016
1.90	0.0041	-0.0155	0.0099	-0.0293	-0.2412
2.00	0.0028	-0.0098	0.0074	-0.0218	-0.1437
2.10	0.0021	-0.0061	0.0055	-0.0160	-0.0884
2.20	0.0016	-0.0038	0.0041	-0.0117	-0.0596
2.30	0.0013	-0.0025	0.0031	-0.0086	-0.0460
2.40	0.0011	-0.0018	0.0024	-0.0063	-0.0402
2.50	0.0009	-0.0014	0.0018	-0.0047	-0.0376
2.60	0.0008	-0.0012	0.0014	-0.0035	-0.0357
2.70	0.0006	-0.0011	0.0011	-0.0027	-0.0333
2.80	0.0005	-0.0010	0.0009	-0.0020	-0.0301
2.90	0.0004	-0.0009	0.0007	-0.0016	-0.0264
3.00	0.0003	-0.0008	0.0005	-0.0013	-0.0224

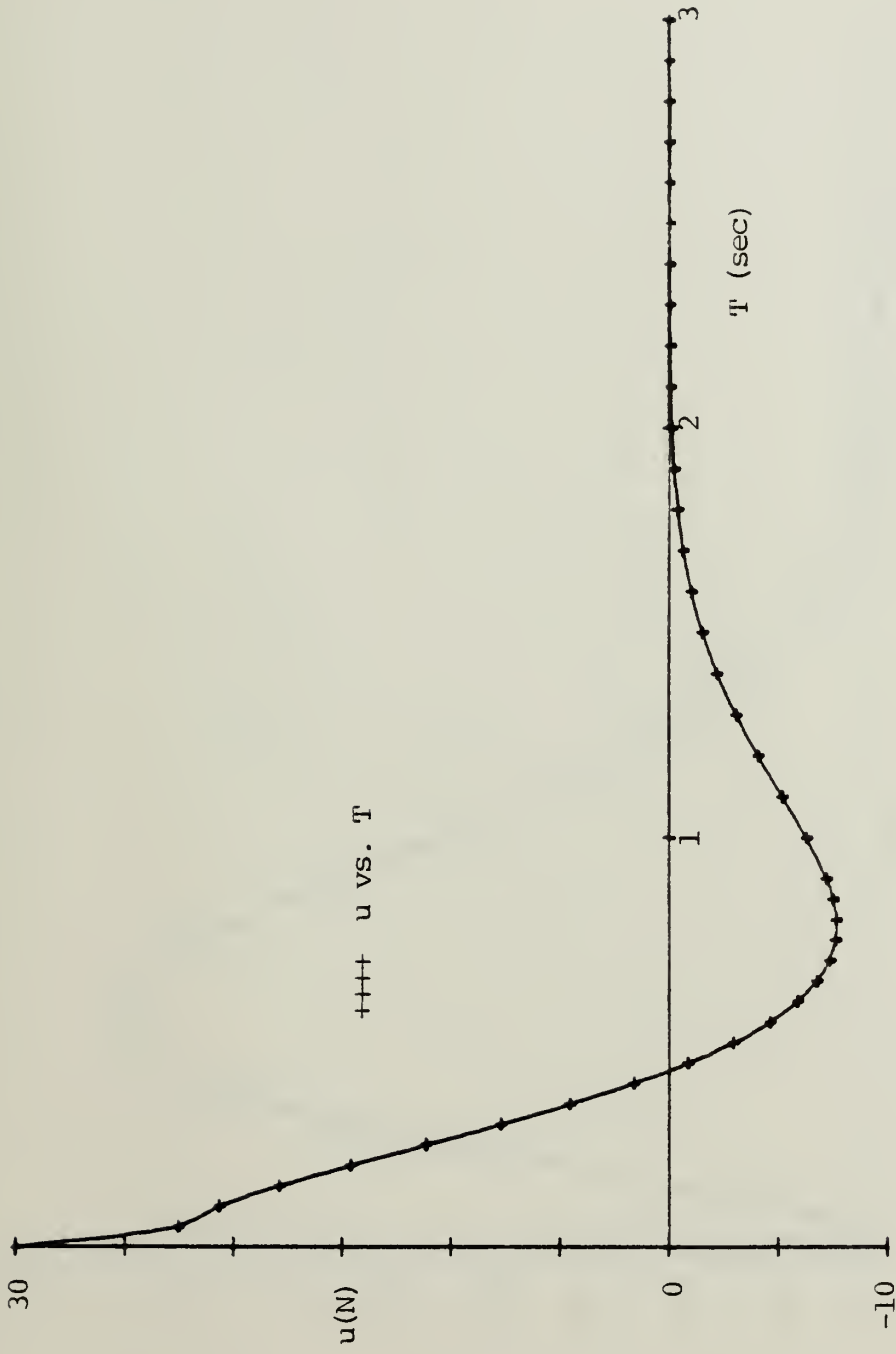

Figure 12. u vs. T STATE VARIABLE FEEDBACK

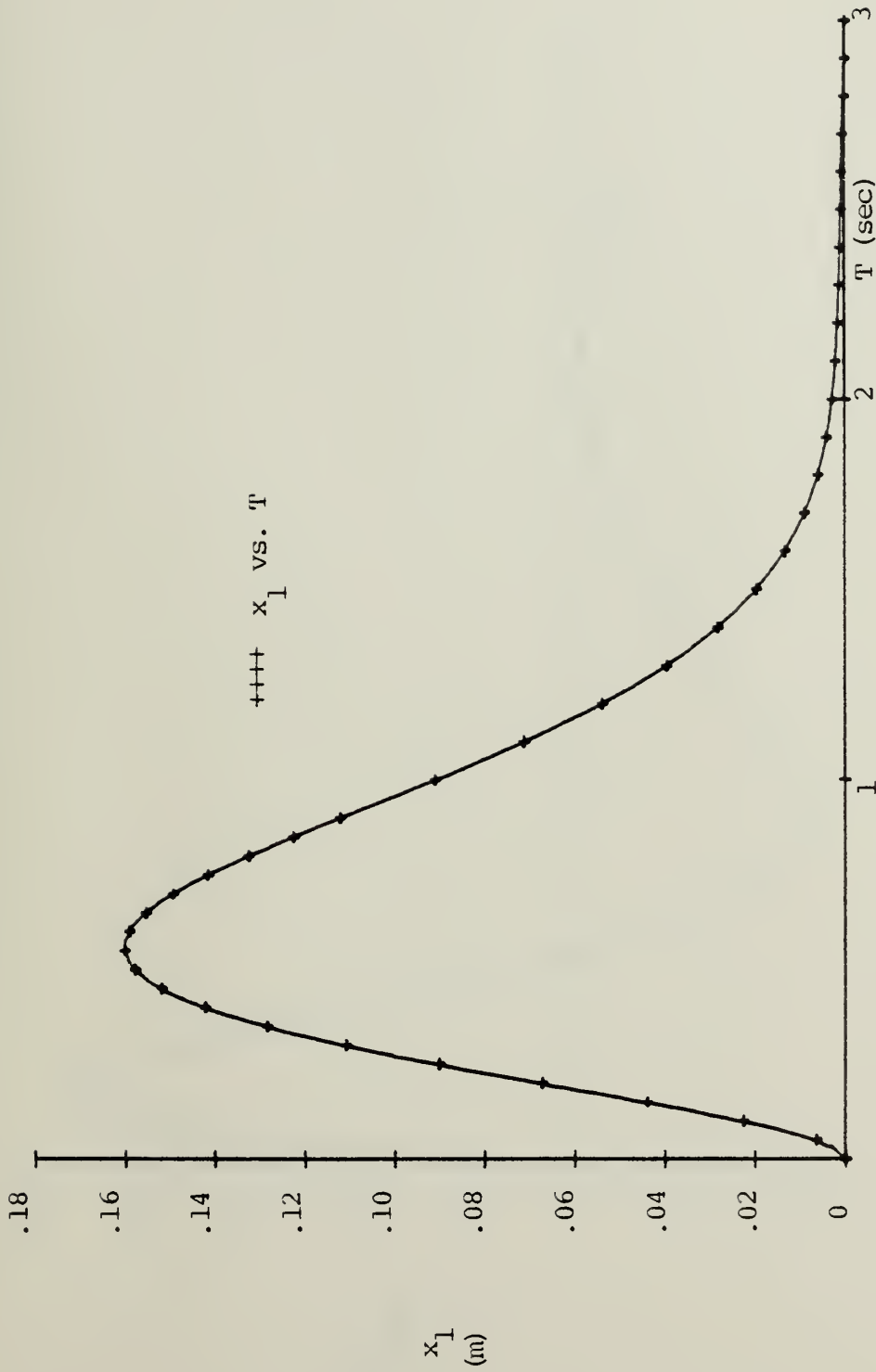

Figure 13. x_1 vs. T STATE VARIABLE FEEDBACK

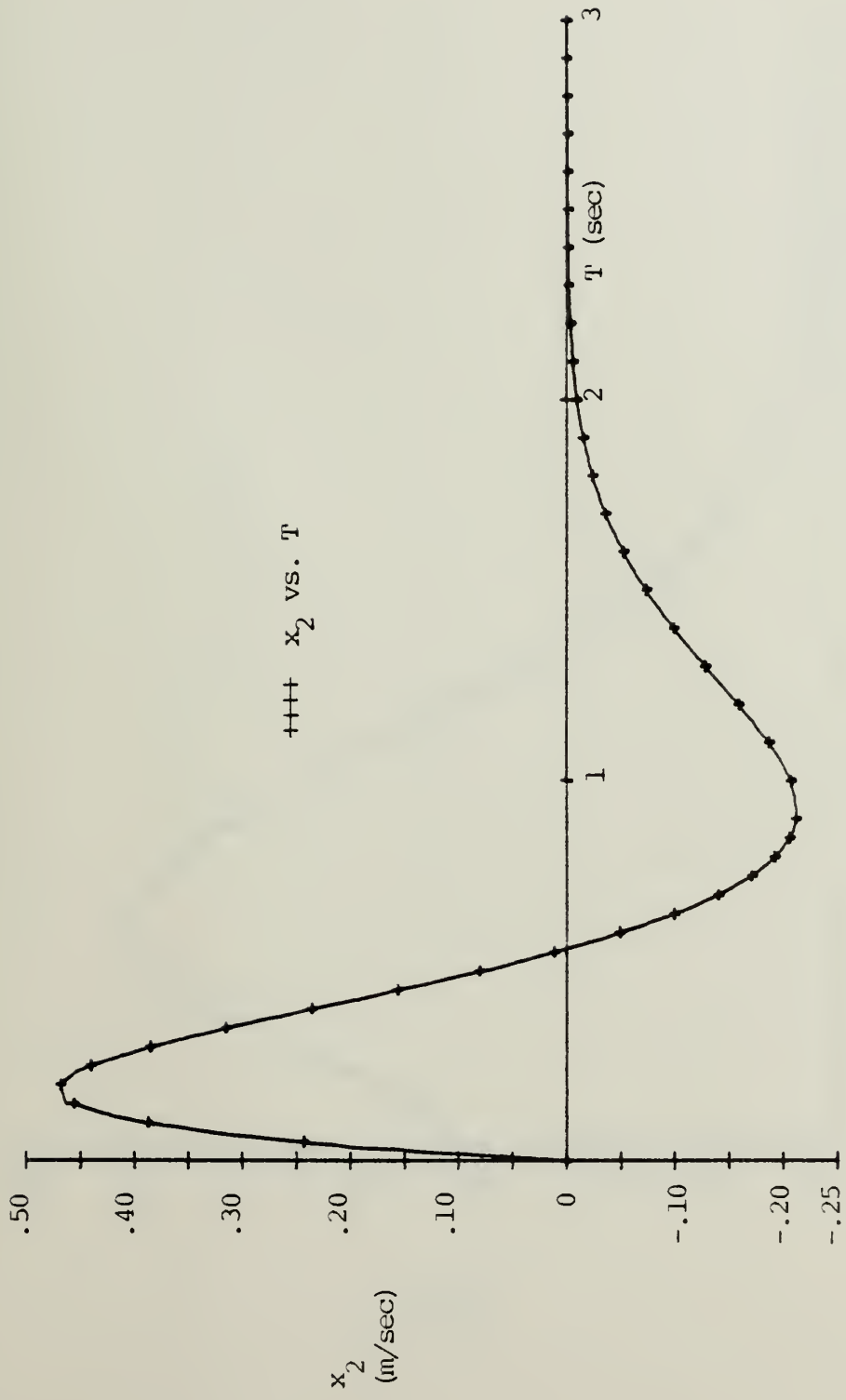

Figure 14. x_2 vs. T STATE VARIABLE FEEDBACK

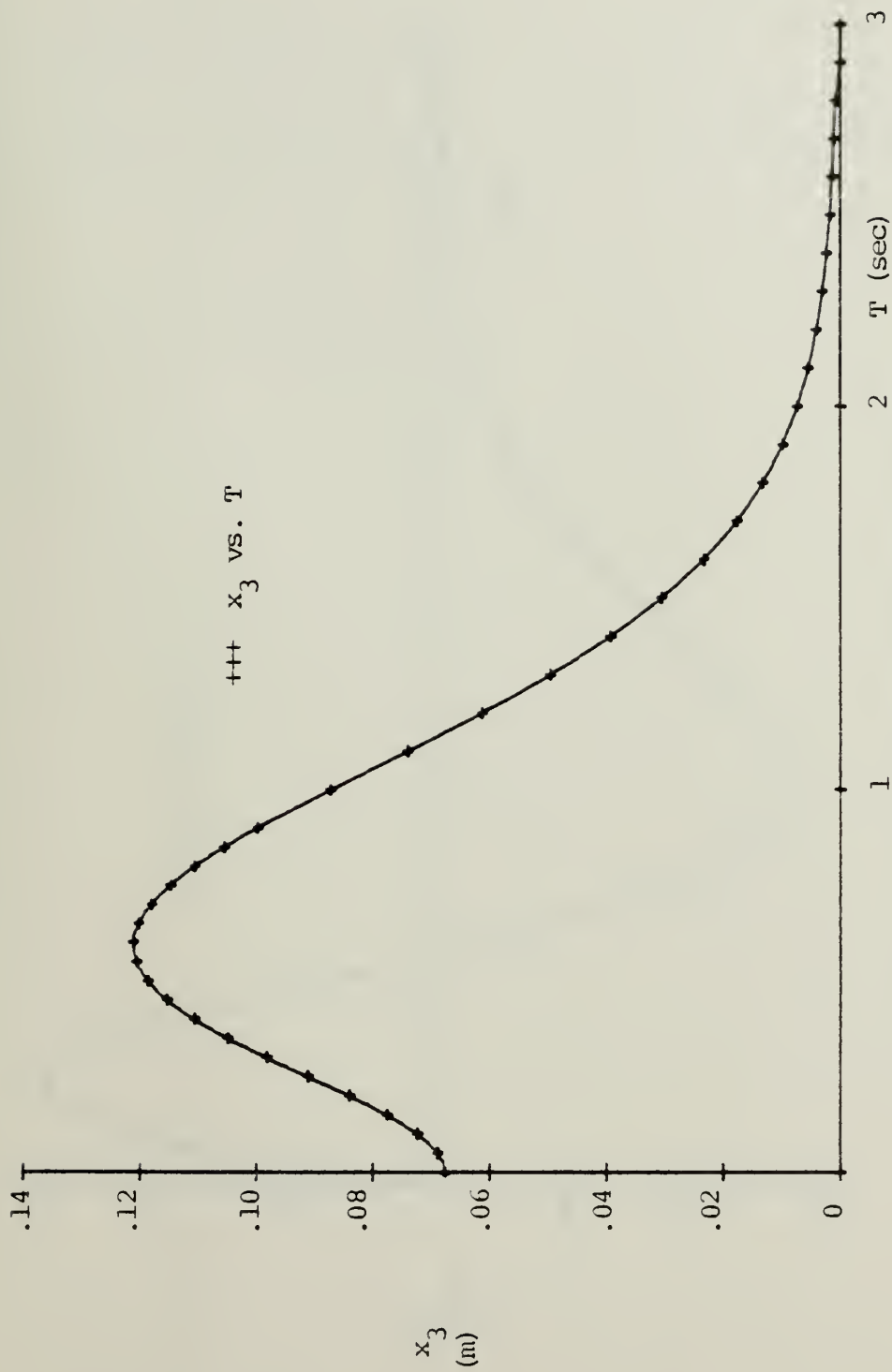

Figure 15. x_3 vs. T STATE VARIABLE FEEDBACK

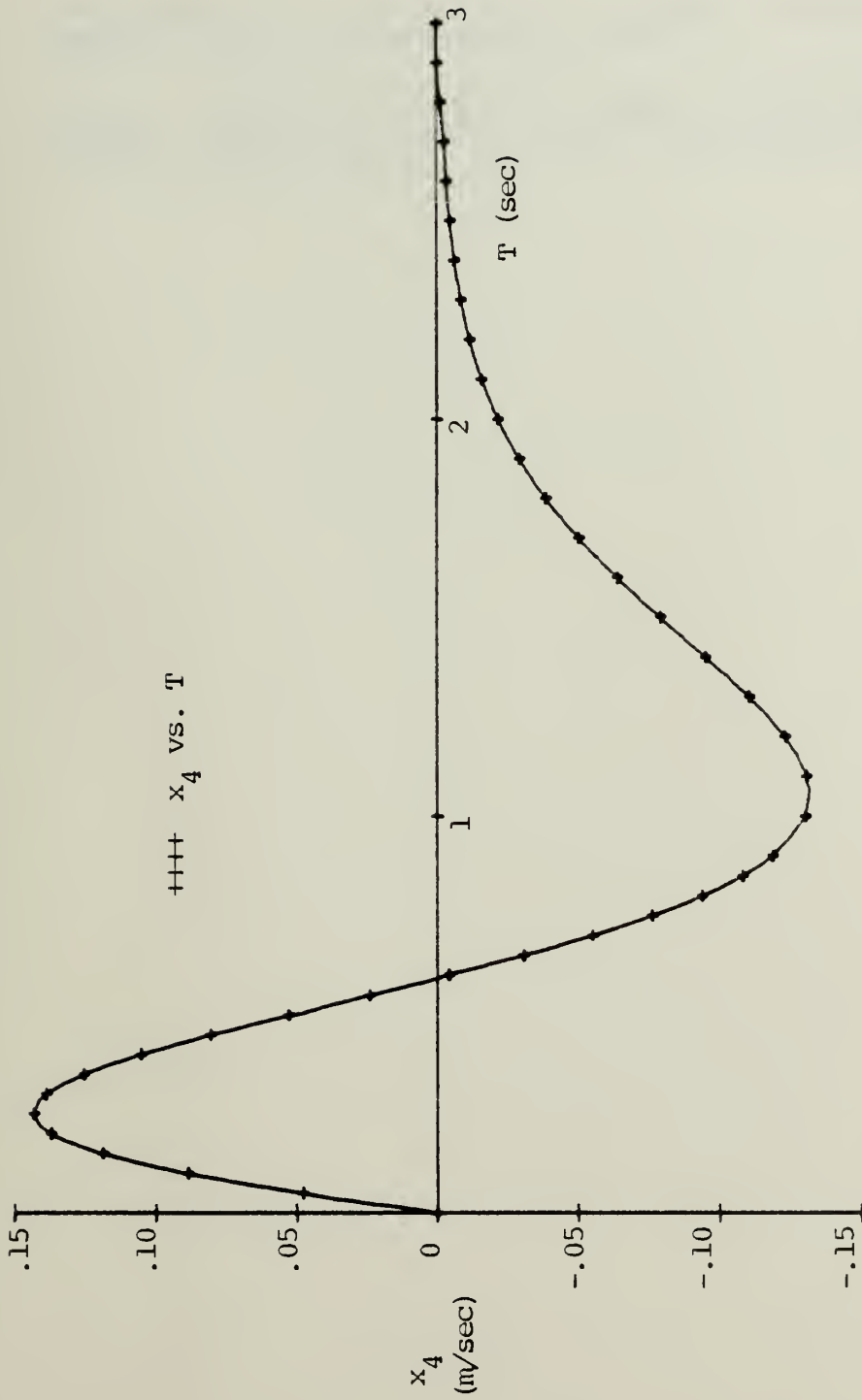

Figure 16. x_4 vs. T STATE VARIABLE FEEDBACK

LIST OF REFERENCES

1. Kwakernaak, H., and Sivan, R., Linear Optimal Control Systems, Wiley-Interscience, 1972.
2. Wan, M., Control of a Simple Case of Inherently Unstable Systems, Master's Thesis, Naval Postgraduate School, Monterey, California, 1965.

INITIAL DISTRIBUTION LIST

	No. Copies
1. Defense Technical Information Center Cameron Station Alexandria, Virginia 22314	2
2. Library, Code 0142 Naval Postgraduate School Monterey, California 93940	2
3. Department Chairman, Code 67 Department of Aeronautics Naval Postgraduate School Monterey, California 93940	1
4. Professor D.J. Collins, Code 67Co Department of Aeronautics Naval Postgraduate School Monterey, California 93940	1
5. LCDR Richard W. Harding P.O. Box 64573 Virginia Beach, Virginia 23464	1

Thesis
H20825 Harding
c.1 Control strategies
of an inverted pendu-
lum.

195446

Thesis
H20825 Harding
c.1 Control strategies
of an inverted pendu-
lum.

195446

thesH20825

Control strategies of an inverted pendul



3 2768 002 08167 1

DUDLEY KNOX LIBRARY