



Calhoun: The NPS Institutional Archive
DSpace Repository

NPS Scholarship

Theses

1969-06

An investigation of the effect of a tangential gas velocity on combustion instability.

Kiel, Joseph Alan

Monterey, California. U.S. Naval Postgraduate School

<https://hdl.handle.net/10945/12423>

This publication is a work of the U.S. Government as defined in Title 17, United States Code, Section 101. Copyright protection is not available for this work in the United States.

Downloaded from NPS Archive: Calhoun



Calhoun is the Naval Postgraduate School's public access digital repository for research materials and institutional publications created by the NPS community. Calhoun is named for Professor of Mathematics Guy K. Calhoun, NPS's first appointed -- and published -- scholarly author.

Dudley Knox Library / Naval Postgraduate School
411 Dyer Road / 1 University Circle
Monterey, California USA 93943

<http://www.nps.edu/library>

NPS ARCHIVE

1969

KIEL, J.

AN INVESTIGATION OF THE EFFECT OF A
TANGENTIAL GAS VELOCITY ON
COMBUSTION INSTABILITY

Joseph Alan Kiel

United States
Naval Postgraduate School



THESIS

AN INVESTIGATION OF THE EFFECT OF A
TANGENTIAL GAS VELOCITY ON
COMBUSTION INSTABILITY

by

Joseph Alan Kiel

June 1969

*This document has been approved for public re-
lease and sale; its distribution is unlimited.*

T133794

DUDLEY KNOX LIBRARY
NAVAL POSTGRADUATE SCHOOL
MONTEREY, CA 93943-5101

An Investigation of the Effect of a Tangential
Gas Velocity on Combustion Instability

by

Joseph Alan Kiel
Lieutenant, United States Navy
B. S., United States Naval Academy, 1961

AERONAUTICAL ENGINEER

from the

NAVAL POSTGRADUATE SCHOOL
June 1969

ABSTRACT

A small, uncooled research rocket motor was built to study the effects of a vortex flow on combustion instability. Normal heptane and air were used as propellants with the air being divided into two flows; a primary flow at the center of the combustion chamber and a secondary flow at the periphery of the chamber. The secondary air provided the swirl which could be directed clockwise or counterclockwise at various angles or a straight mode of operation. Runs were made at various flow rates with the direction of swirl changed during the run.

A first tangential high frequency mode of combustion instability was developed and a significant change in stability conditions was found when a vortex flow was generated within the combustion chamber. It was found that a swirl in one direction tended to decrease the instability while a flow in the opposite direction increased it.

TABLE OF CONTENTS

I.	INTRODUCTION -----	11
II.	DEFINING THE PROBLEM -----	13
III.	METHOD OF INVESTIGATION -----	21
IV.	DESCRIPTION OF APPARATUS -----	29
V.	RESULTS -----	58
VI.	DISCUSSION OF RESULTS -----	65
VII.	CONCLUSIONS -----	72
	REFERENCES -----	74
	INITIAL DISTRIBUTION LIST -----	75
	FORM DD 1473 -----	77

LIST OF TABLES

Table	Page
I. Summary of Instrumentation	53
II. Summary of Data	60

LIST OF FIGURES

Figure		Page
1.	Speed of Sound for Normal Heptane and Air	16
2.	Instability Boundaries for Vaporization Model	18
3.	Instability Boundaries for Vaporization Model with Vortex Flow	20
4.	Schematic Diagram of Propellant Supply System	22
5.	Air Supply Tanks	30
6.	Propellant Supply System Components	31
7.	Propellant Supply System	32
8.	Schematic Diagram of Fuel System	34
9.	Fuel Flow Rate Determination	36
10.	Cross-Section of Rocket Motor	37
11.	Disassembled Rocket Motor	38
12.	Cross-Section of Fuel Injector	39
13.	Air Injector Manifold	40
14.	Air Injector Manifold	41
15.	Air Orifice Plate and Air Swirling Plate	42
16.	Air Swirling Plate and Insert	44
17.	Completed Assembly of Orifice and Swirling Plates	45
18.	Rocket Body	46
19.	Igniter	47
20.	Igniter	48

Figure	Page
21. Nozzle	50
22. Assembled Rocket Motor	51
23. Assembled Rocket Motor on Thrust Stand	52
24. Recording Instrumentation	54
25. Fuel Control Console	56
26. Control Panel	57
27. Visicorder Oscillograph Data	62
28. Oscillatory Pressure from Photocon	64

TABLE OF SYMBOLS

a	Speed of sound in medium
C^*	Characteristic exhaust velocity
CCW	Counterclockwise
CW	Clockwise
D	Diameter
f	Frequency of oscillation
L	Length of combustion chamber
λ	Burning rate parameter
m	Tangential wave number
n	Radial wave number
P	Pressure
P_c	Steady-state chamber pressure
P_p	Non-dimensional peak-to-peak pressure disturbance
q	Longitudinal wave number
R	Radius of combustion chamber
T	Temperature
$\alpha_{m,n}$	n^{th} root of J_n Bessel function of the first kind
ΔP	Differential pressure

ACKNOWLEDGMENTS

The author gratefully acknowledges the guidance, time and effort furnished by his thesis advisor, Dr. David W. Netzer, during this investigation. Without his interest the completion of this project would have been in serious doubt.

A special note of gratitude is expressed to Mr. Edward Michelson for his continued effort in the construction, maintenance and improvement of the rocket motor and to Mr. Theodore B. Dunton whose wide technical knowledge was put to use innumerable times in a variety of problems.

The author also expresses his gratitude to Mr. Cecil R. Gordon for his countless hours of work on the electrical instrumentation of this project; to Mr. Glenn A. Middleton and Mr. Michael F. Odell for special assistance in the construction and reconstruction of numerous parts of the system; and to the technicians in the Department of Aeronautics who in any way made this study possible.

Finally, but by no means least, the author would be remiss if he not acknowledge the perseverance of his wife, Mary Lou, whose understanding over the past year made this effort possible.

I. INTRODUCTION

One of the most perplexing problems in the study and design of modern high performance rocket engines is the attempt to control or eliminate combustion instability. This undesirable oscillation of chamber pressure can result in excessive heat transfer to the walls of the chamber causing thermal or mechanical failure.

A number of analytical and experimental models have been developed to study the chamber pressure fluctuations and their interrelation with the combustion process. A propellant vaporization model described by Priem and Heidman [Ref. 1] assumed the steady-state combustion process to be vaporization rate controlling. Reference 2 investigated instability limits in a toroidal ring used to represent the combustor. This same combustor was utilized by Priem [Ref. 3] to set up various instability models in which different combustion steps were individually assumed to be rate controlling. By adding a constant vortex velocity to the instability model in which vaporization was assumed to be rate controlling, Priem developed a vortex flow model in which a dramatic change in stability limits was found.

In Refs.4 and 5 a two-dimensional circular liquid propellant combustor was used to study the effect of tangentially injecting nitrogen gas into the combustor of a burning liquid oxygen jet. It was found that transverse combustion instability was induced

by the nitrogen. The significance of a tangential velocity in the combustion chamber as a means of controlling instability was investigated in Ref. 6. It was postulated that a tangential flow of propellants in a direction opposite to the transverse instability would cause the wave to damp.

The purpose of this study was to build a rocket motor that could be made inherently unstable and then study the effect on stability limits of injecting propellant into the combustion chamber with a vortex motion. Bi-phase propellants were used in which the velocity of the oxidizer could be varied in both magnitude and direction.

II. DEFINING THE PROBLEM

Combustion instability refers to undesirable pressure oscillations which are driven by the combustion process. It can occur in both solid and liquid propellant engines. In liquid propellant engines the pressure oscillations fall into three categories: low-, intermediate-, and high-frequency instability. The first two types are not serious problems and it is the high-frequency combustion oscillations, associated with the acoustic vibrational modes of the combustion chamber, that are most often encountered and most destructive.

The high-frequency oscillations begin with small disturbances in the combustion chamber and are amplified by the interaction between the combustion process and the resonant effects of the chamber geometry. These oscillations can be divided into longitudinal and transverse modes in which properties vary along the chamber axis or perpendicular to it, respectively. The transverse mode can be further divided into radial and tangential modes and has a frequency in the actual combustor which closely approximates the acoustic frequency of the corresponding mode. The tangential modes of oscillation are the most common and cause the most damage [Ref. 7].

From the wave equation which governs the flow field for an acoustic medium the following relationship is found for the frequency of oscillations [Ref. 8]:

$$f_{m,n,q} = \frac{a}{2} \sqrt{\left(\frac{\alpha_{m,n}}{R}\right)^2 + \left(\frac{q}{L}\right)^2}$$

where a = speed of sound in the medium

$\alpha_{m,n} = n^{\text{th}}$ root of J_n Bessel function of the first kind

R = radius of combustion chamber

L = length of combustion chamber

m, n, q = wave numbers

Although this equation is for small oscillations only, it has been found by experimental observation to be quite accurate for large amplitude oscillations also. Pure modes of acoustic oscillation occur when only one of the wave numbers is not zero:

$m \neq 0, \quad n = q = 0$ tangential modes

$n \neq 0, \quad m = q = 0$ radial modes

$q \neq 0, \quad m = n = 0$ longitudinal modes

Thus the pure modes can be found by the following relations:

$$f = \frac{\alpha_{m,n} a}{2R} \quad \text{tangential and radial modes}$$

$$f = \frac{qa}{2L} \quad \text{longitudinal modes}$$

Solutions to the Bessel function roots ($\alpha_{m,n}$) are given below

[Ref. 9]:

m \ n	0	1	2	3
0	0.000	1.220	2.233	3.238
1	0.586	1.697	2.714	3.726
2	0.972	2.135	3.173	4.192
3	1.337	2.551	3.611	4.643

The speed of sound is proportional to the chamber temperature which is dependent on the mixture ratio and to a small extent on the chamber pressure. Figure 1 shows a plot of the speed of sound versus mixture ratio for various chamber pressures. This information was obtained from Ref. 10.

Since the tangential modes of oscillation are the most important and it was using these modes that the vortex flow model predicted a dramatic change in stability limits, the initial problem in this investigation was to produce this type of instability. Secondly, these modes had to be identified. Finally, it was necessary to show that a vortex flow in the combustion chamber had an effect on this instability.

The first problem was solved by controlling the velocity of the fuel and oxidizer so that the mass mean drop size of the fuel would be conducive to instability [Ref. 11]. The information from Ref. 11 was for a different injector arrangement and was employed as a starting point with a trial-and-error approach used to obtain instability.

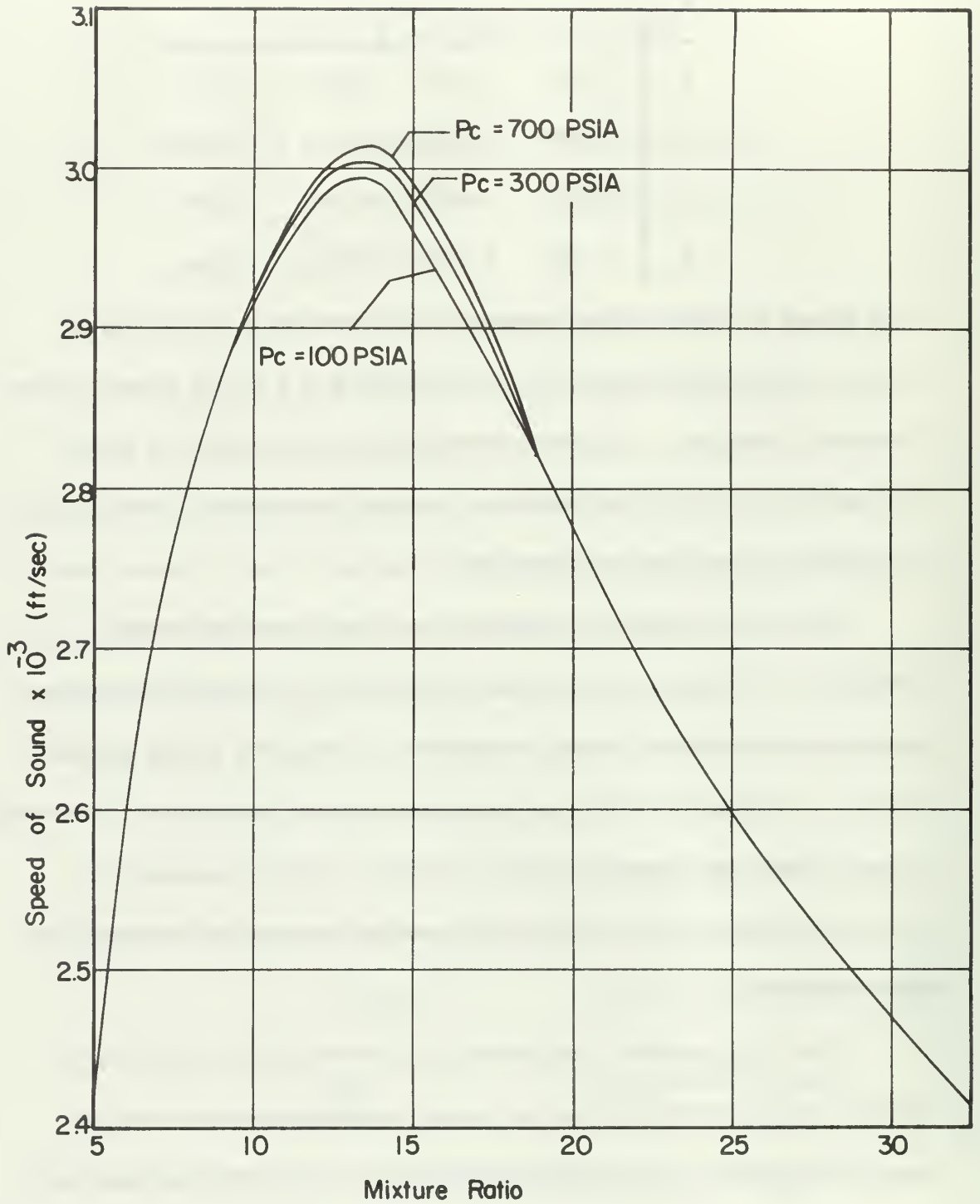

FIGURE 1 .SPEED OF SOUND FOR NORMAL HEPTANE AND AIR

The identification of the mode of instability was accomplished by determining the frequency of the pressure oscillations and comparing this frequency with that predicted by using the speed of sound and combustor geometry.

In the steady-state vaporization model the assumption was made that the vaporization rate of propellant drops was much slower than their injection, accumulation, atomization or chemical reaction rates [Ref. 1]. Therefore, this was the rate controlling mechanism. This vaporization model was used to obtain an expression for the instantaneous local burning rate [Ref. 3]. Using this and the transport equations developed in Ref. 2 the stability limits for the vaporization limited stability model of a toroidal ring combustor were determined. These stability boundaries were taken from Ref. 3 and are presented in Fig. 2. The vaporization mass accumulation factor is proportional to the quantity of unvaporized material present and the burning rate parameter proportional to the combustor radius, combustor contraction ratio and average burning rate of propellant per length of combustor. In the present study this average burning rate was not determined and therefore the burning rate parameter was unknown. This curve was used to obtain a qualitative feeling for the stability boundaries with no vortex flow in the combustor.

The effect of a constant vortex velocity in the combustion chamber was studied [Ref. 3] by developing a vortex flow model. This model used the vaporization limited stability model of a toroidal

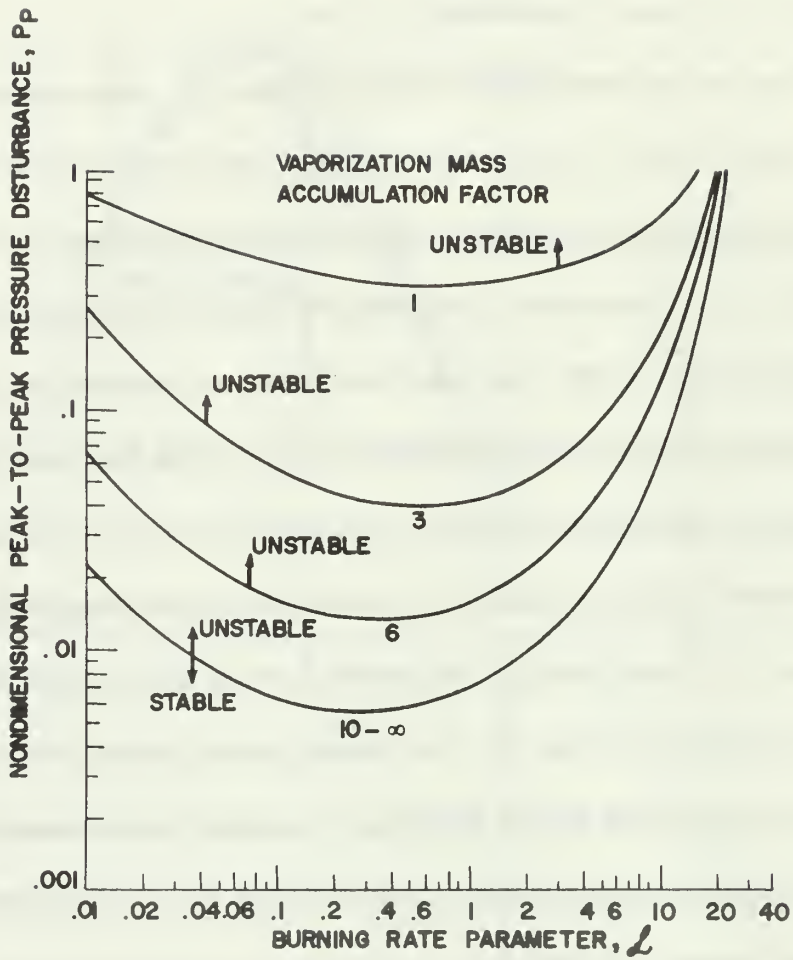

FIGURE 2. INSTABILITY BOUNDARIES FOR VAPORIZATION MODEL
[REF. 3]

ring combustor and added a constant vortex velocity to values of the gas velocity in the tangential direction. The significant change in stability limits caused by a small vortex velocity can be seen in Fig.3 which was taken from Ref. 3. As the vortex velocity increased the burning rate parameter of the propellant required to obtain instability became less.

Since the burning rate parameter was not determined, the correlation of this investigation with Priem's vortex flow model was necessarily qualitative; the primary concern being the establishment of a change in stability limits with a constant vortex velocity. Another aim was to test the postulation of Ref. 6 that a vortex flow in one direction would cause a decrease in instability while a flow in the opposite direction would increase it.

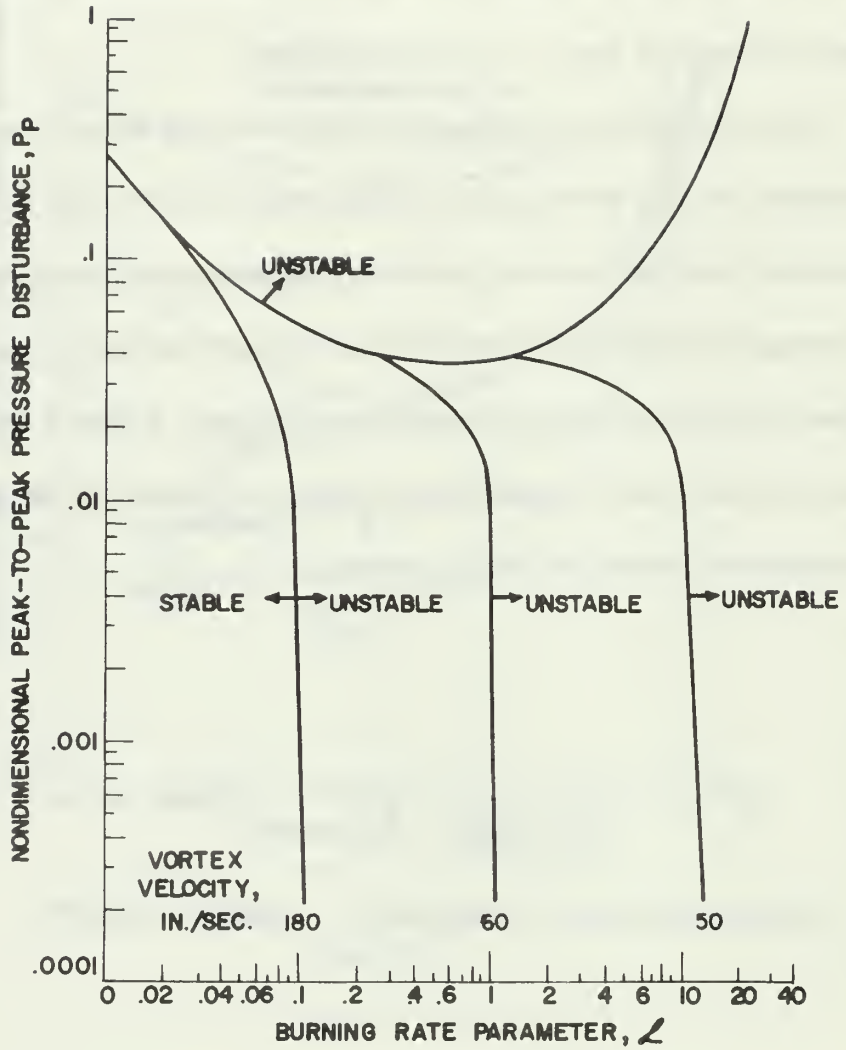

FIGURE 3 .INSTABILITY BOUNDARIES FOR VAPORIZATION MODEL WITH VORTEX FLOW [REF. 3]

III. METHOD OF INVESTIGATION

The purpose of this study was to determine the effect of a vortex velocity on combustion instability and to experimentally verify the analytical results of Refs. 3 and 6.

The rocket motor used for this investigation was an uncooled, research combustor. It had a combustion chamber with a diameter of four inches and a length of approximately $5 \frac{9}{16}$ inches. A complete description of the rocket motor and propellant supply system is given in the next section. The nozzle of the motor was a separate portion and capable of being changed for various experiments. All of the runs for this investigation were accomplished with one nozzle.

The propellants used were normal heptane and air. Air was supplied to the rocket motor from high pressure air tanks maintained at approximately 3000 psi. The air was separated in the test cell so that one flow provided primary air to the center of the combustion chamber and the other provided secondary air to injectors at the periphery of the combustion chamber. Both of the flows were routed through air filters, pressure regulating valves, orifices and flow regulating valves. Additionally the secondary flow was divided into three flows, each controlled by a solenoid valve, prior to being directed to the peripheral injectors (See Fig. 4).

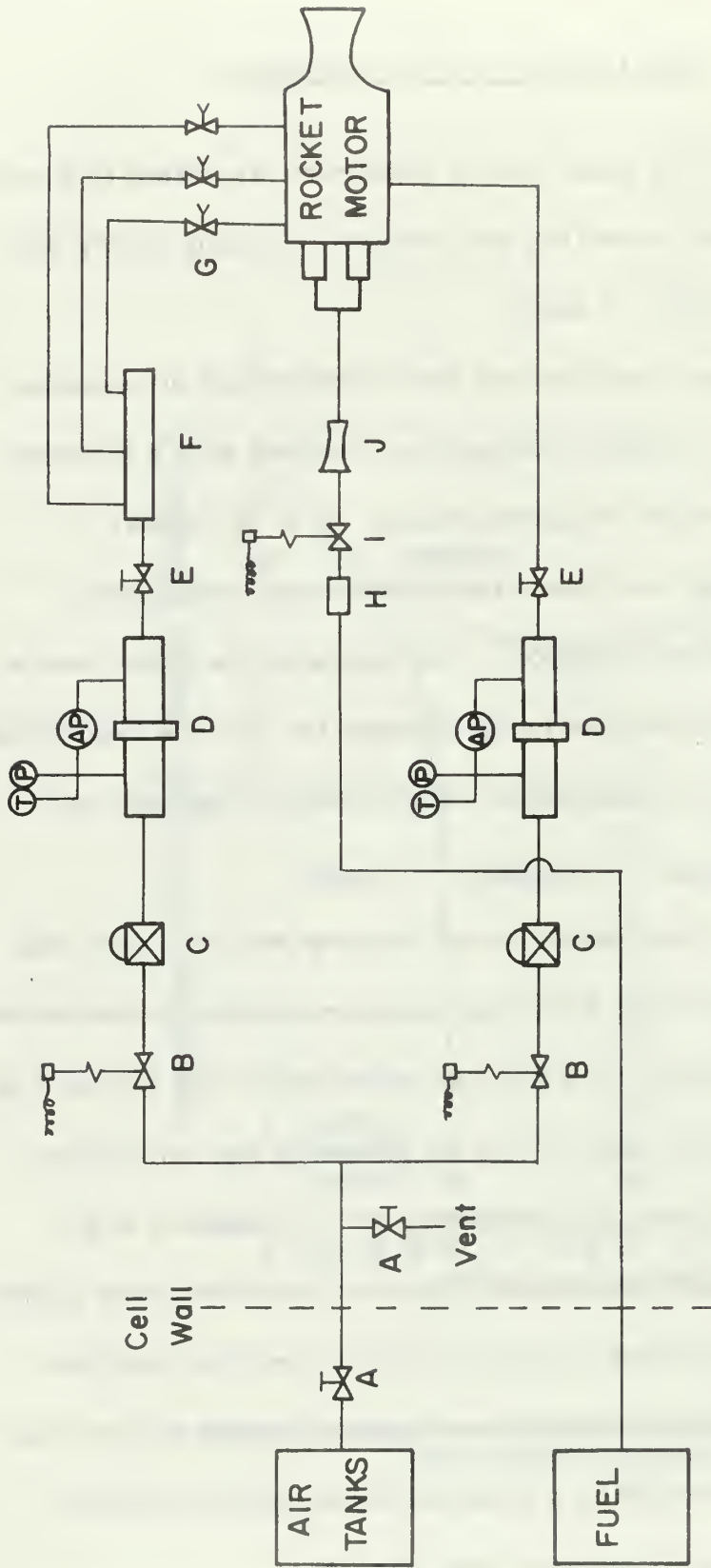

- A : Shut-off Valve
- B : On-Off Actuator
- C : Pressure Regulator
- D : Orifice
- E : Flow Regulator

- F : Air Manifold
- G : Solenoid Valve
- H : Fuel Filter
- I : On-Off Actuator
- J : Cavitating Venturi

FIGURE 4. SCHEMATIC DIAGRAM OF PROPELLANT SUPPLY SYSTEM

Each of the solenoid controlled secondary flows was directed to four injector elements equally spaced at the face of the combustion chamber. These injector elements were inserts that could be positioned to direct the flow clockwise or counterclockwise (as viewed from the injector) into the combustion chamber. The three flows were set up so that one flow would be straight, one clockwise and one counterclockwise. The inserts were removable so that the effect of varying flow angles could be studied. The secondary air was controlled from the console room by three on-off switches each activating one solenoid. With the solenoids individually controlled any desired sequence or combination of flows could be obtained.

Fuel was supplied from a 20 gallon tank through a filter and cavitating venturi and injected into the center of the primary air flow. A methane-oxygen igniter was utilized to ignite the motor and was disengaged by a pressure switch when the chamber pressure reached approximately 75 per cent of the expected steady-state value.

A typical sequence for firing the rocket motor was:

- 1) Start the igniter,
- 2) Allow secondary air to flow into the combustion chamber in the straight and counterclockwise direction,
- 3) Allow primary air to flow into the combustion chamber,
- 4) Allow fuel to flow into the combustion chamber at which time the motor ignited,

- 5) Igniter disengaged at approximately 75 per cent of the expected steady-state chamber pressure ,
- 6) After approximately 1 1/2 seconds switch to a combination of straight and clockwise secondary air flow ,
- 7) After approximately 1 1/2 more seconds switch to straight secondary air flow only ,
- 8) Stop fuel flow ,
- 9) Stop primary air flow ,
- 10) Allow secondary air flow to purge and cool the motor for about 30 seconds before stopping it .

Originally it was planned to have about half of the air flow through the primary and half through the secondary with variations from these values to determine the effect on stability. The solenoids were unable to pass this amount of air, however and the secondary flow had to be reduced to about 15-20 per cent of the total air flow. The alternative of reducing the total air flow with a proportional reduction in fuel flow was rejected because the desired chamber pressure and other operating conditions would be adversely affected.

The effect of this secondary air flow was observed by removing the nozzle from the motor and visually sighting the circulating motion of the fuel induced by the peripheral air. The tangential velocity imparted by the secondary air could also be felt when this was the only air flowing. Although this velocity was higher than would be expected with the nozzle on the motor it gave an indication of the order

of magnitude of the swirl. Since Priem's vortex flow model predicted that only small vortex velocities were required for substantial changes in stability limits, it was felt that 15-20 per cent of the total air flow was more than sufficient for the required tangential velocity to study the current problem.

The parameters which could be varied to determine the effect on combustion instability were:

- 1) Amount of air given a vortex velocity: This was controlled by the percentage of the air that flowed through the secondary air system.
- 2) Direction of the secondary air injection: inserts giving an initial directional change of 20, 30 and 40 degrees to the motor's axial centerline were available.
- 3) Fuel flow rate.

Pressures, temperatures and differential pressures at the orifices were used to determine air flow rates. The rocket motor was instrumented to obtain fuel and air manifold pressures, steady-state chamber pressure and the oscillatory chamber pressure. A Model 352A Photocon pressure transducer was used to obtain the pressure variation and to determine the stability of the combustion process. The data from this Photocon was recorded on tape and then played back into a visicorder oscillograph. All other readings were recorded on the oscillograph.

An investigation conducted by Netzer [Ref. 11] with a very similar rocket motor using the same bi-phase propellants indicated that the combustion process was either spontaneously unstable or so stable that it could not be driven unstable. Although the injector elements used in Netzer's research were considerably different from those of the present study, the approximate fuel mass mean drop size determined in Ref. 11 was used as an initial attempt to produce instability. From that drop size the appropriate ratio between fuel and oxidizer velocities, and thus areas, was obtained. This area ratio was eventually adjusted to obtain the desired level of instability.

A number of problems were encountered in the initial firing of the rocket motor. The fuel tube first used did not atomize the fuel sufficiently and resulted in severe popping as the motor attempted to start. A number of different injector elements were tried in an attempt to reach a compromise between proper atomization of the fuel and conditions for the proper operation of the cavitating venturi. A fuel area that was too large would not allow the fuel to break up sufficiently for proper combustion. When the fuel area was too small the partial blockage caused a high fuel manifold pressure which prevented proper cavitation of the venturi and decreased the fuel flow to a value too low for combustion. This problem was solved by first designing a fuel injector which provided better atomization of the fuel, then constructing a smaller venturi and using a higher fuel supply pressure to obtain the desired fuel flow rate.

The hole at the center of the rocket motor that provided primary air to the center of the combustion chamber was enlarged to accommodate the increased size of the fuel injector that was finally selected. This hole was also bevelled at an angle of 45 degrees at the outlet which allowed an expanding flow to enter the combustion chamber. Since this flow was choked providing sonic conditions between the air manifold and the combustion chamber, the increased area caused the primary air to become supersonic just prior to entering the combustion chamber. Therefore a shock wave occurred as the air became subsonic upon entering the combustion chamber. The fuel injector was designed with holes drilled back toward the injector face at a 45 degree angle. The interaction between this fuel and the shock wave provided the mixing needed for combustion.

The igniter did not operate properly at the outset and it was determined that the peripheral air flow was causing the flame from the igniter to be blown along the wall of the combustion chamber. Thus it never reached the combustible mixture. The igniter operation was improved by enlarging the area of the controlling solenoids, increasing the size of the supply lines and increasing the supply pressure. An attempt was also made to improve the efficiency of the igniter by moving it farther from the fuel injector where it would be igniting more thoroughly mixed reactants. When the proper fuel injector was inserted however, the mixture in the

combustion chamber was mixed sufficiently so that the position of the igniter was not critical and it was returned to its original location.

IV. DESCRIPTION OF APPARATUS

A schematic diagram of the propellant supply system is shown in Fig. 4. Air was supplied from fourteen air tanks pressurized to approximately 3000 psi. These tanks were surplus submarine items obtained from the Puget Sound Naval Shipyard and are shown in Fig. 5. They were pressurized by an Ingersoll-Rand 10.1 cfm, 3500 psig compressor. A dryer and a filter processed the air prior to it reaching the storage tanks.

A hand operated shut-off valve located near the compressor allowed the air to flow via 1 1/2 inch pipe to the rocket cell. At the rocket cell a hand operated vent valve was used to relieve system pressure at the end of a run. The air was then divided into a primary flow which provided a straight flow at the center of the rocket motor and a secondary flow which was directed to the periphery of the motor and provided the tangential velocity. Photographs of the propellant supply system are shown in Figs. 6 and 7.

Each flow branch contained a filter, on-off actuator, pressure regulator, orifice and flow regulator. The filters consisted of screening elements enclosed in stainless steel casings which were pressed into emergency use when planned commercial filters were delayed in shipment. The Jamesbury on-off valve actuators were operated by 75 psi nitrogen and actuated by a 110 volt AC system.

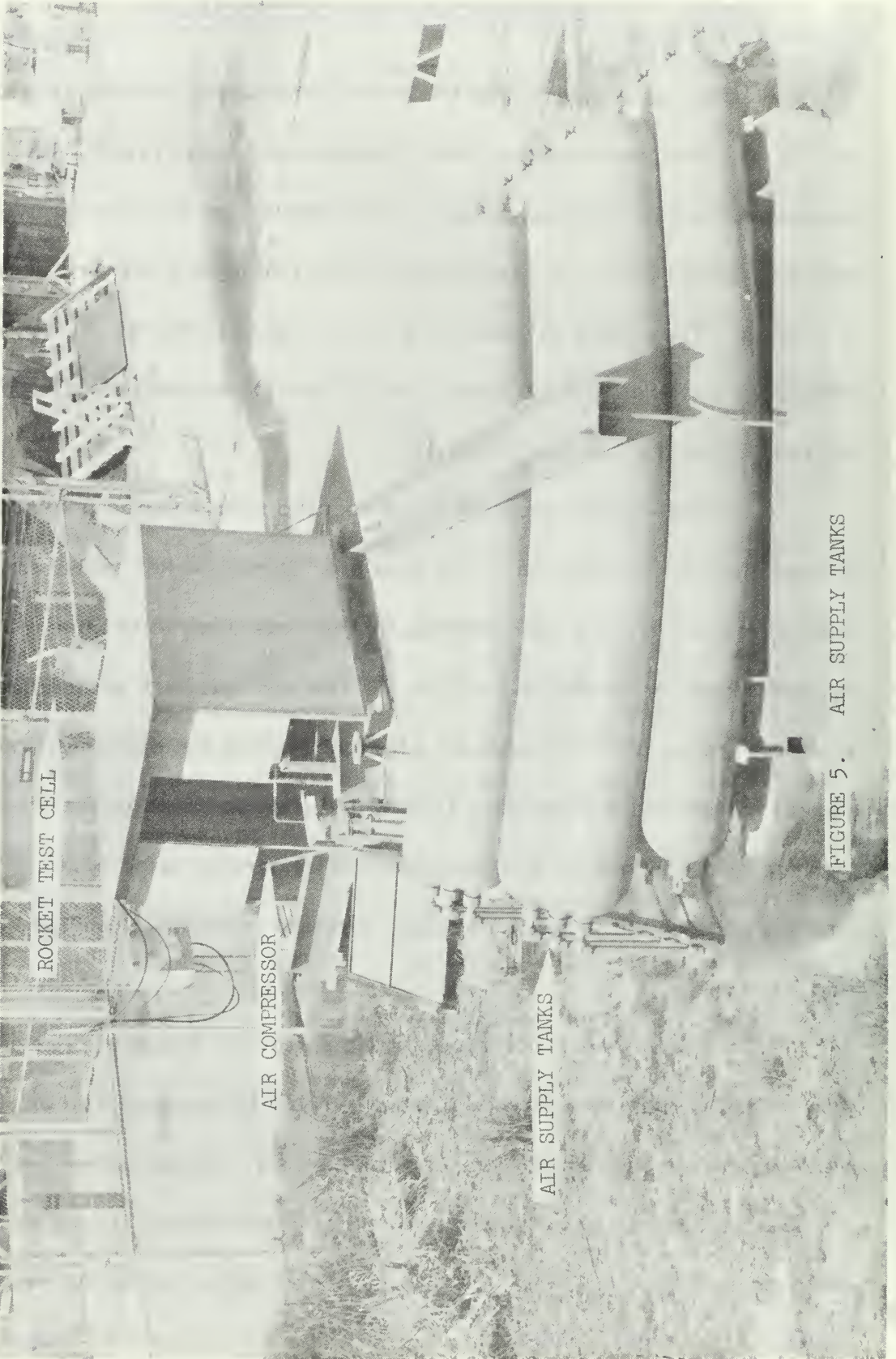

ROCKET TEST CELL

AIR COMPRESSOR

AIR SUPPLY TANKS

FIGURE 5. AIR SUPPLY TANKS

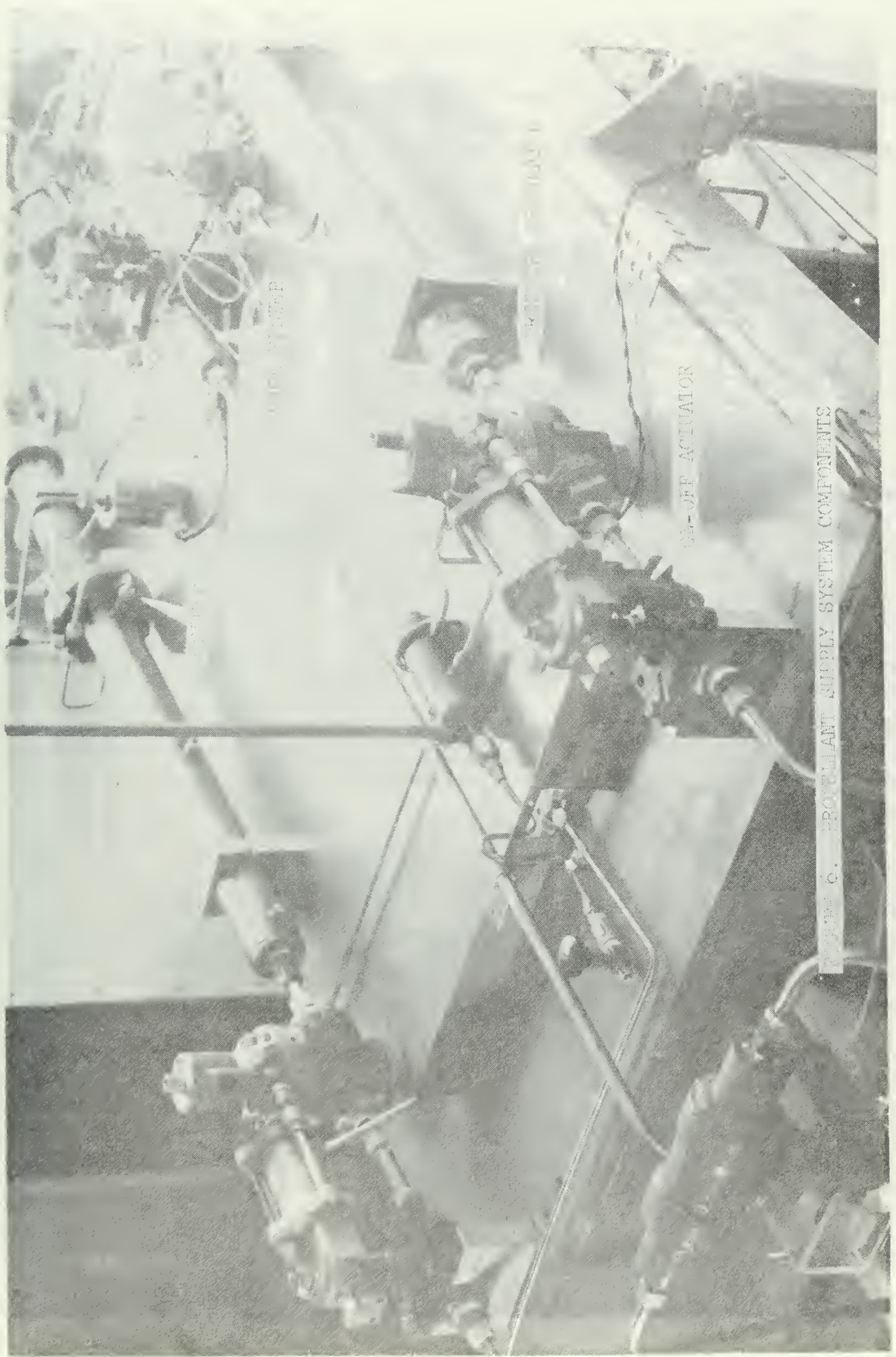

OFF ACTUATOR

OFF ACTUATOR

PROPELLANT SUPPLY SYSTEM COMPONENTS

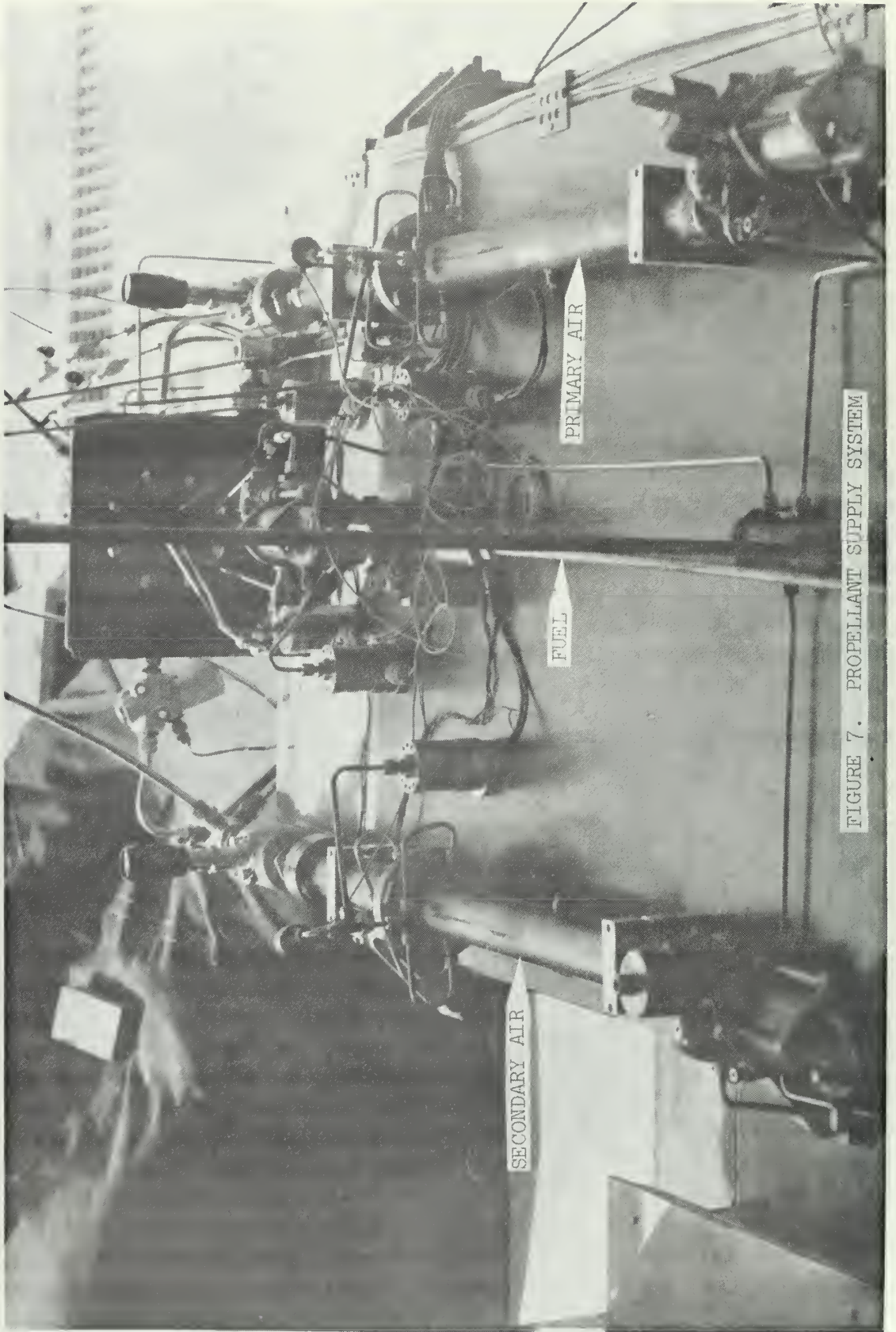

FIGURE 7. PROPELLANT SUPPLY SYSTEM

Grove pressure regulators were used to reduce the supply pressure to the desired operating value of 1500 psia. The concentric, thin-plate, square-edged orifices used 1 D and 1/2 D pressure taps [Ref. 12]. The pressures upstream of the orifices were measured with Teledyne pressure transducers and the pressure difference across the orifices with Wiancko differential pressure transducers. Hand operated Grove flow regulators were opened until the differential pressure transducers indicated that the desired flow rate was obtained.

The primary air flowed directly into the motor. The secondary air was directed into a manifold from which three tubes were connected to the rocket motor. Each tube contained a Marotta solenoid valve actuated by a 24 volt DC system and controlled from the console room. These valves determined whether the peripheral air flow would be straight, swirled clockwise or swirled counter-clockwise in the combustor.

Fuel was supplied from a 20 gallon tank in an adjoining cell. This fuel tank was pressurized with nitrogen to a value commensurate with the fuel flow rate desired. The schematic diagram of this fuel system is shown in Fig. 8. In the rocket cell the fuel passed through a filter and then a Jamesbury on-off valve actuator. The fuel flow rate was determined by using a cavitating venturi. The venturi was calibrated by comparing the pressure from a transducer immediately upstream of the venturi with a measured flow rate. Calibration

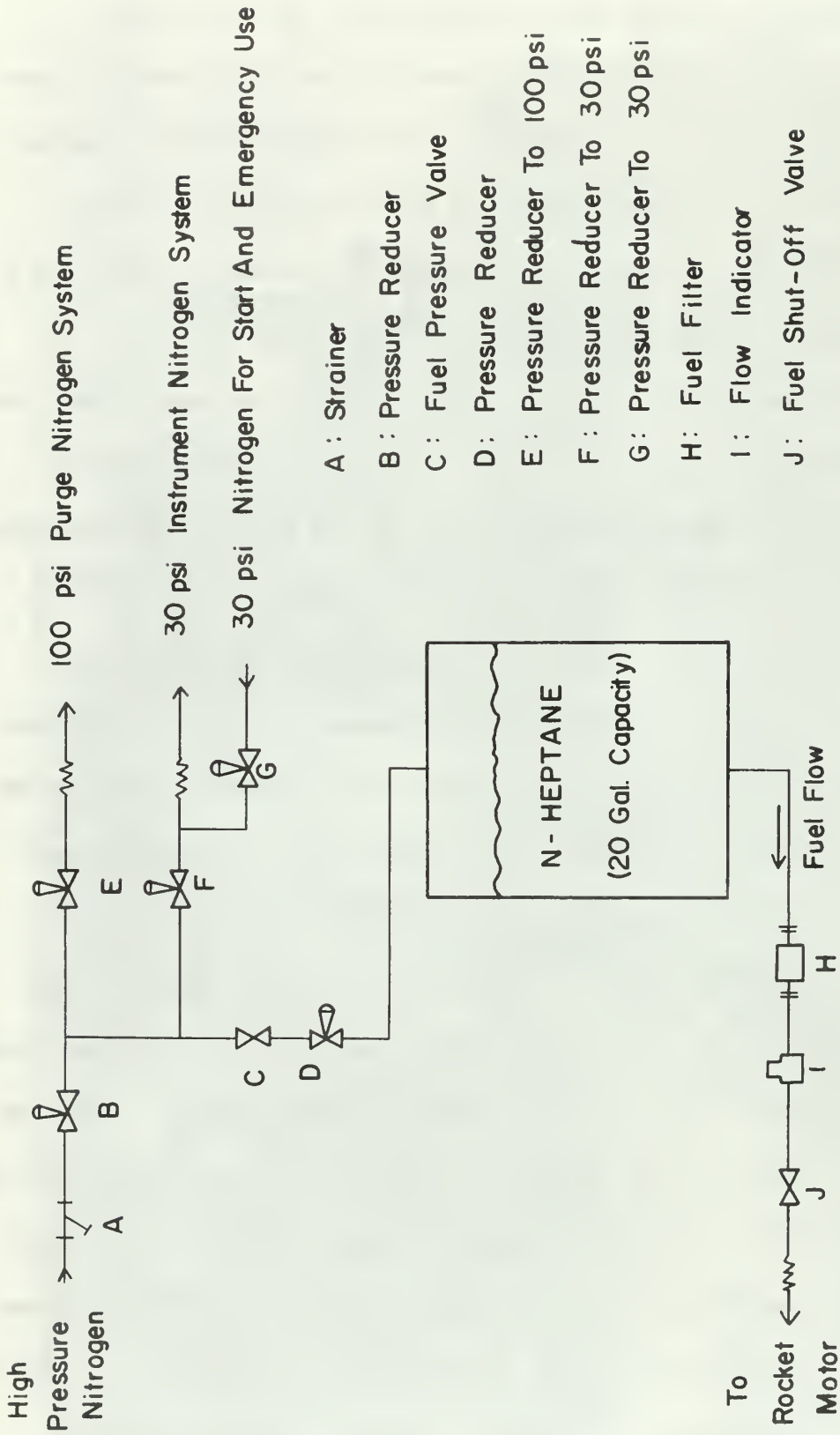

FIGURE 8 SCHEMATIC DIAGRAM OF FUEL SYSTEM

curves for both the supply and venturi pressures versus fuel flow rate are shown in Fig. 9. After the cavitating venturi the fuel flow was divided into four tubes prior to entering the rocket motor. This was done for more equitable fuel distribution in the fuel manifold.

The cross-section of the rocket motor is shown in Fig. 10 and a photograph of the disassembled rocket in Fig. 11. Fuel entered the motor through four one-fourth inch tubes and was directed into the combustion chamber through a .085 inch inner diameter fuel tube with a cap on the end. The cap had sixteen holes on the periphery and one on the end. The side holes were drilled back toward the injector face at a 45 degree angle to provide better fuel and air mixing. A cross-section of the fuel injector is shown in Fig. 12.

Primary air was directed into the area around the fuel injector and entered the combustion chamber at the center of the rocket motor. The secondary air entered the rocket motor via one of three one-half inch tubes in the air injector manifold. Each tube was blocked, forming a small manifold from which four one-fourth inch tubes were led. Figure 13 shows a drawing of this air injector manifold and Fig. 14 a photograph of it. Each set of four tubes was equally spaced on a 3 1/2 inch diameter. The one-fourth inch tubes were then maneuvered through an air orifice plate and into inserts in the air swirling plate. Figure 15 shows the air swirling plate and air orifice plate as originally designed.

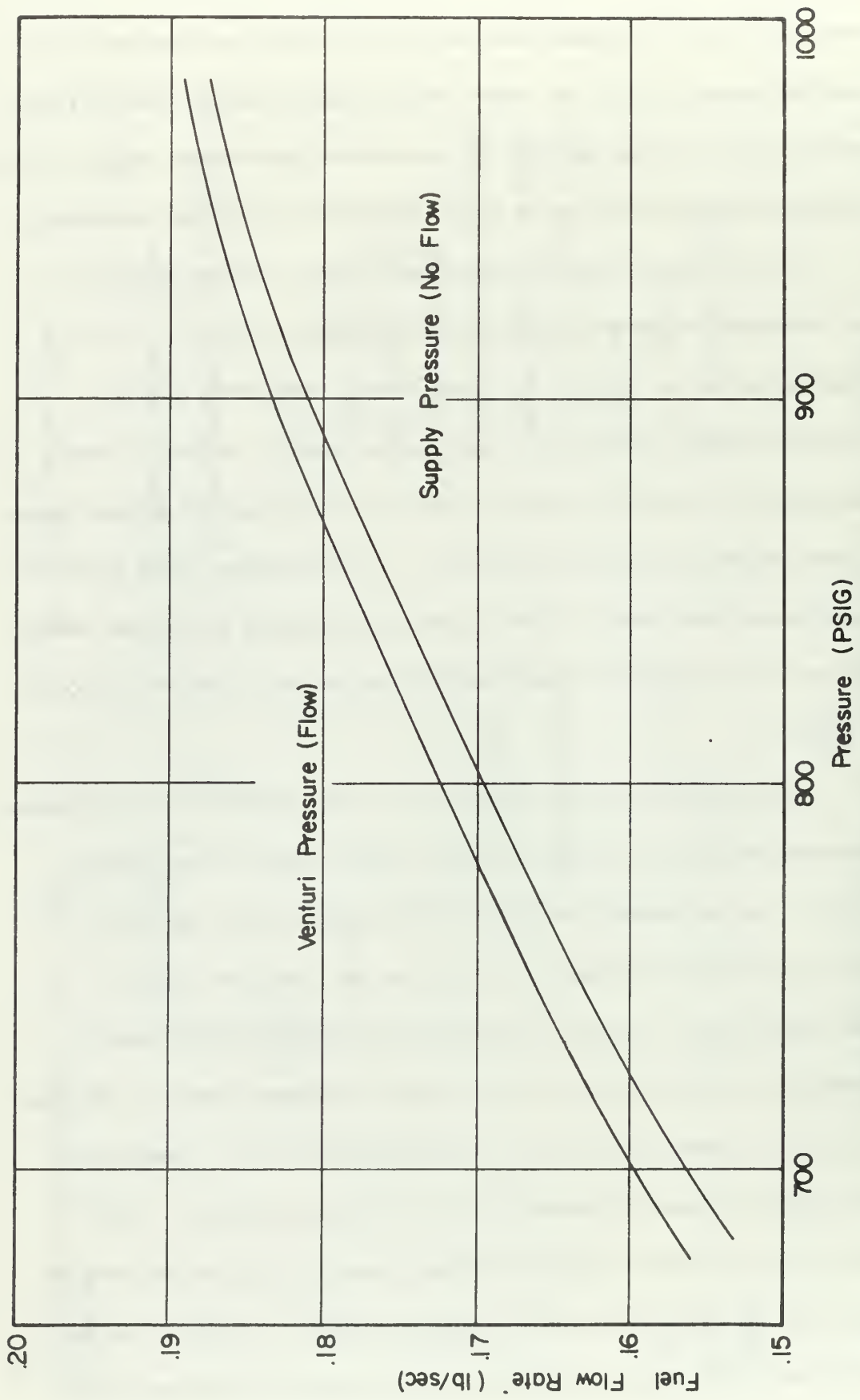

FIGURE 9 . FUEL FLOW RATE DETERMINATION

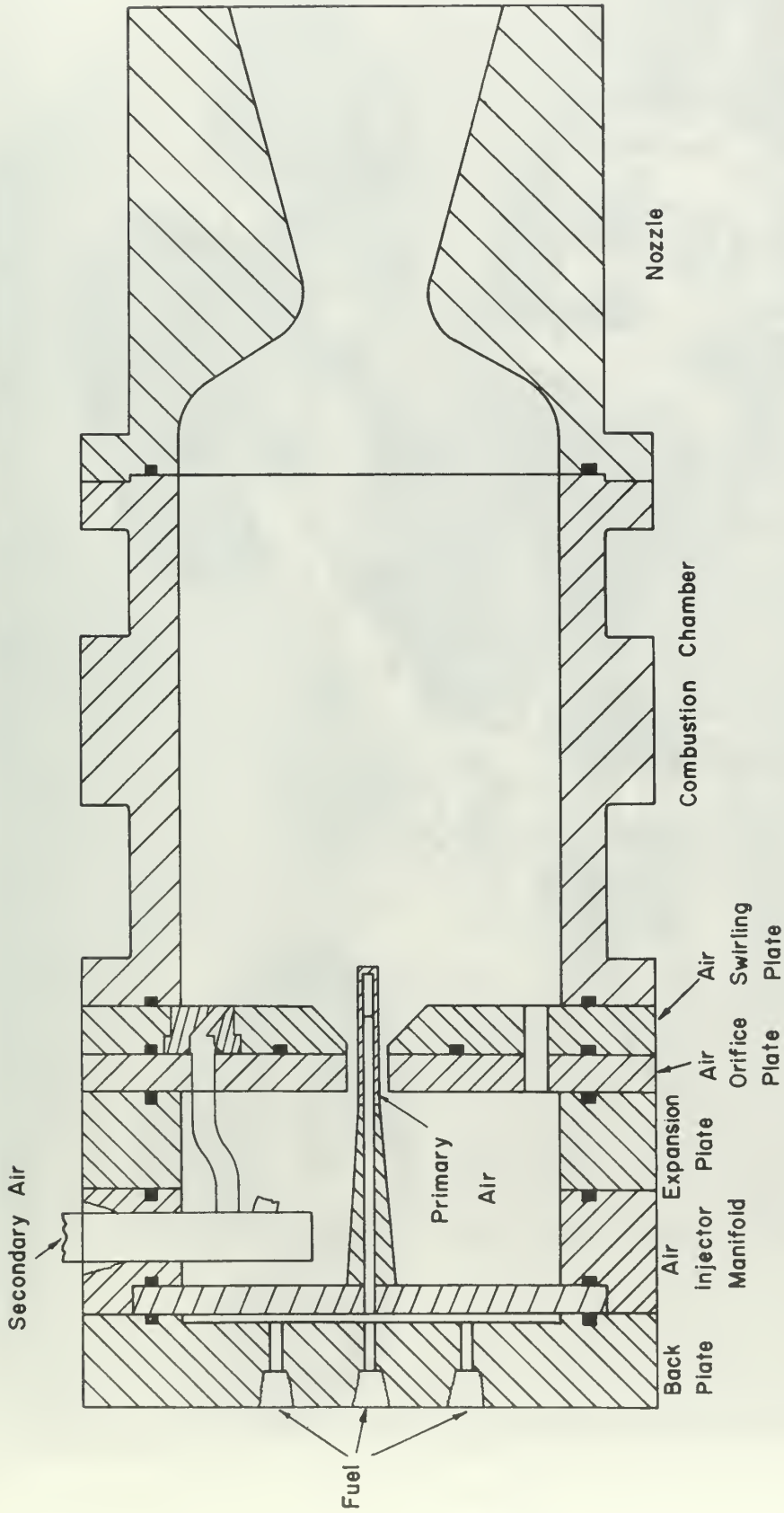
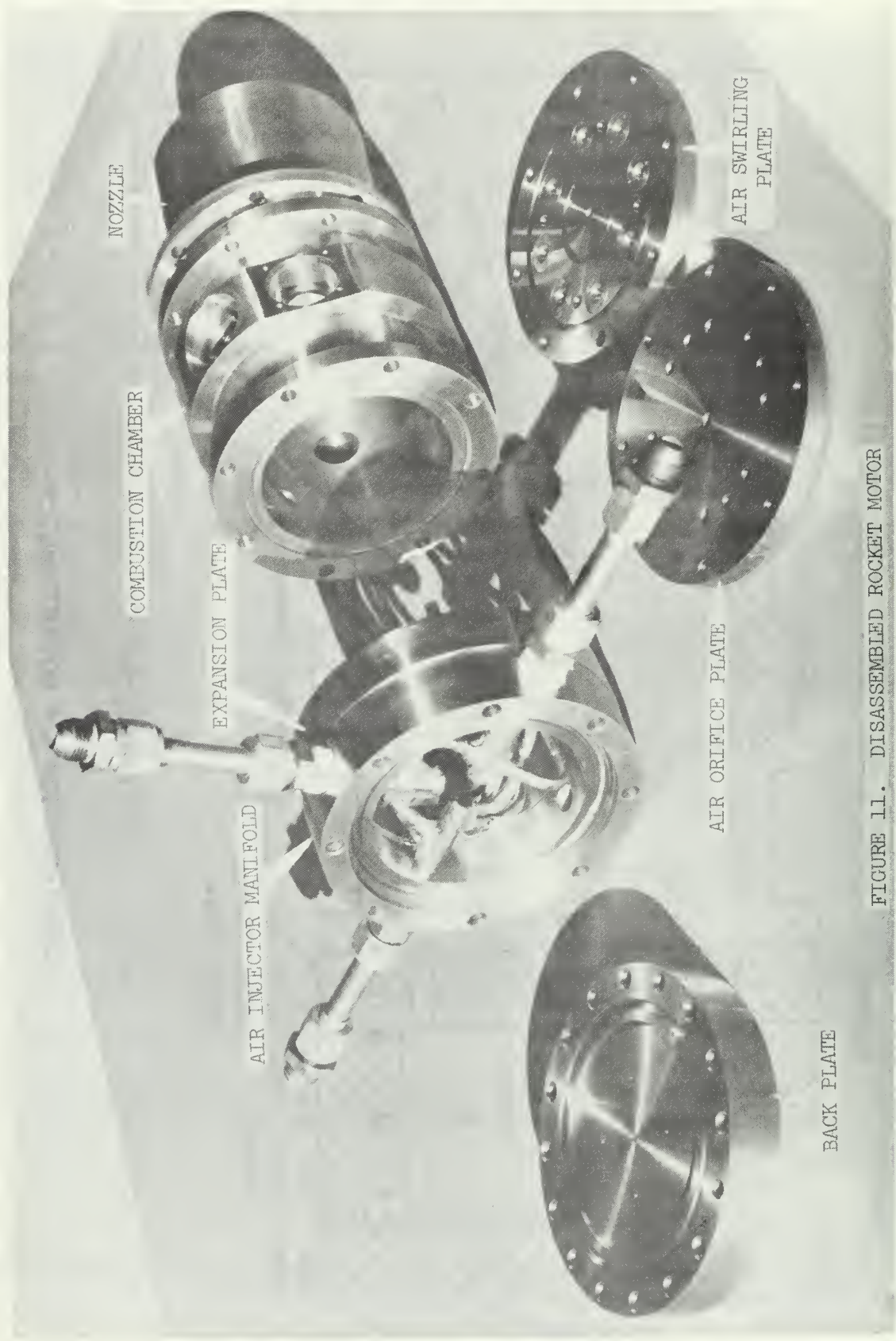

FIGURE 10.

CROSS-SECTION OF ROCKET MOTOR



NOZZLE

COMBUSTION CHAMBER

EXPANSION PLATE

AIR INJECTOR MANIFOLD

AIR SWIRLING
PLATE

AIR ORIFICE PLATE

BACK PLATE

FIGURE 11. DISASSEMBLED ROCKET MOTOR

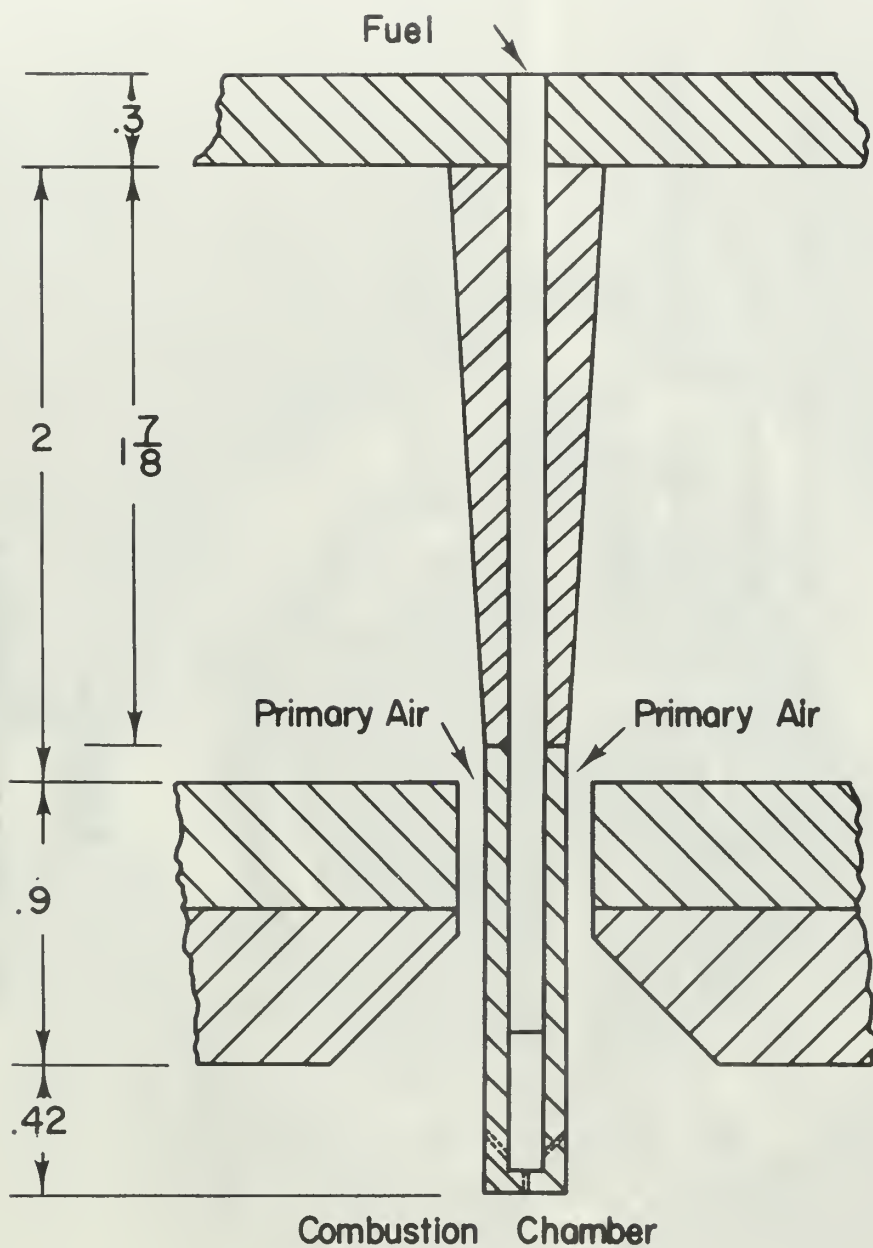
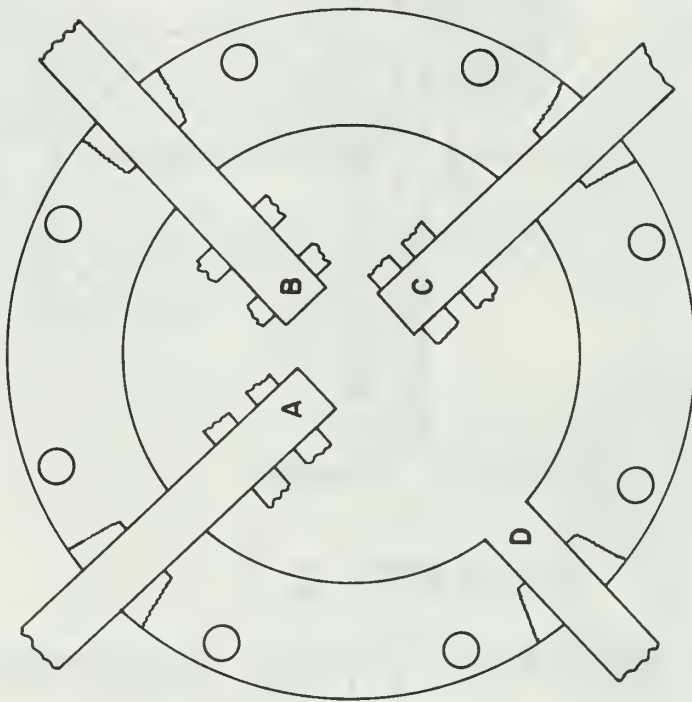

FIGURE 12.
CROSS-SECTION OF FUEL INJECTOR



A-Secondary Air, Clockwise Swirl *

B-Secondary Air, No Swirl

C- Secondary Air, Counterclockwise Swirl *

D - Primary Air

* As Viewed From Injector

FIGURE 13.

AIR INJECTOR MANIFOLD

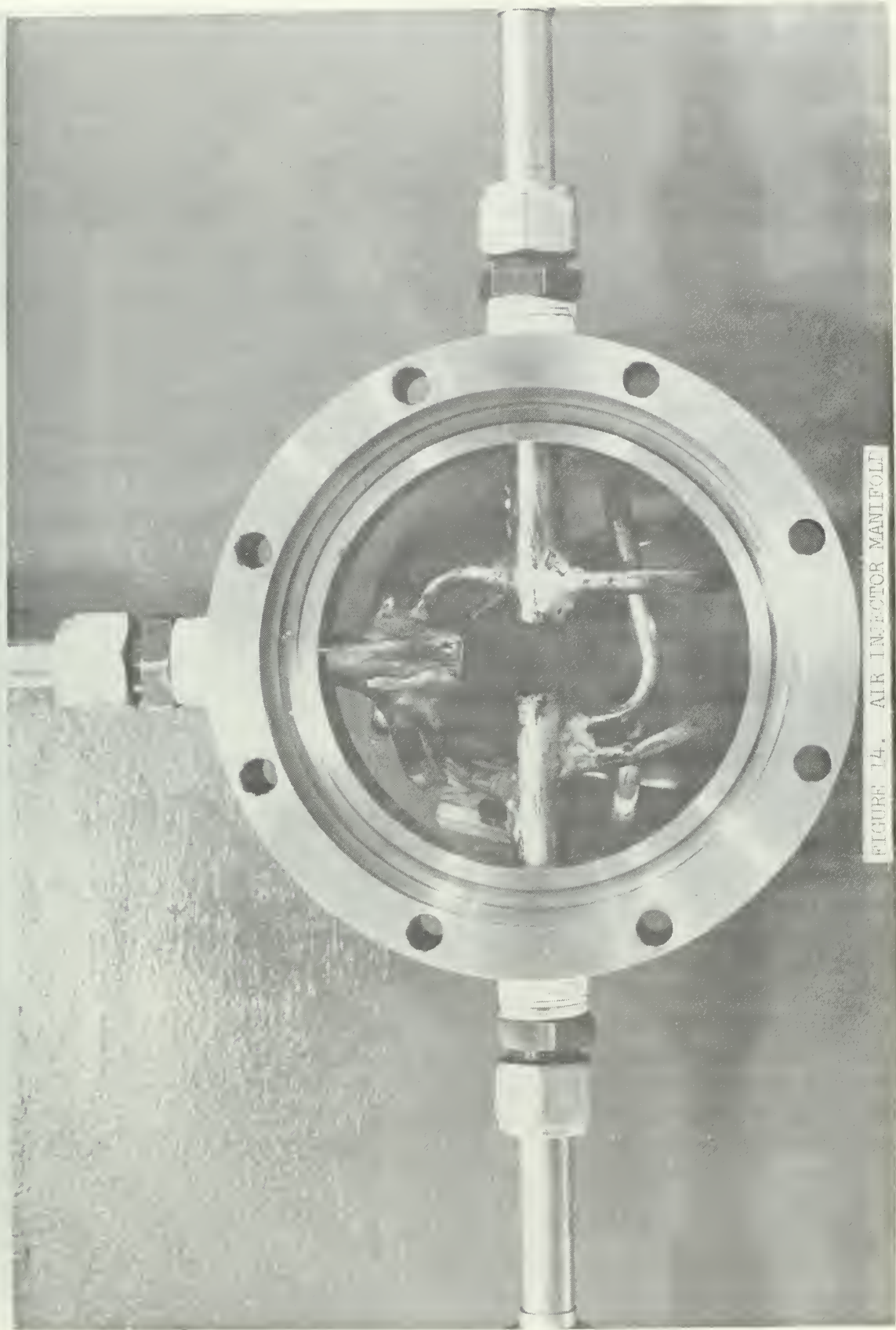
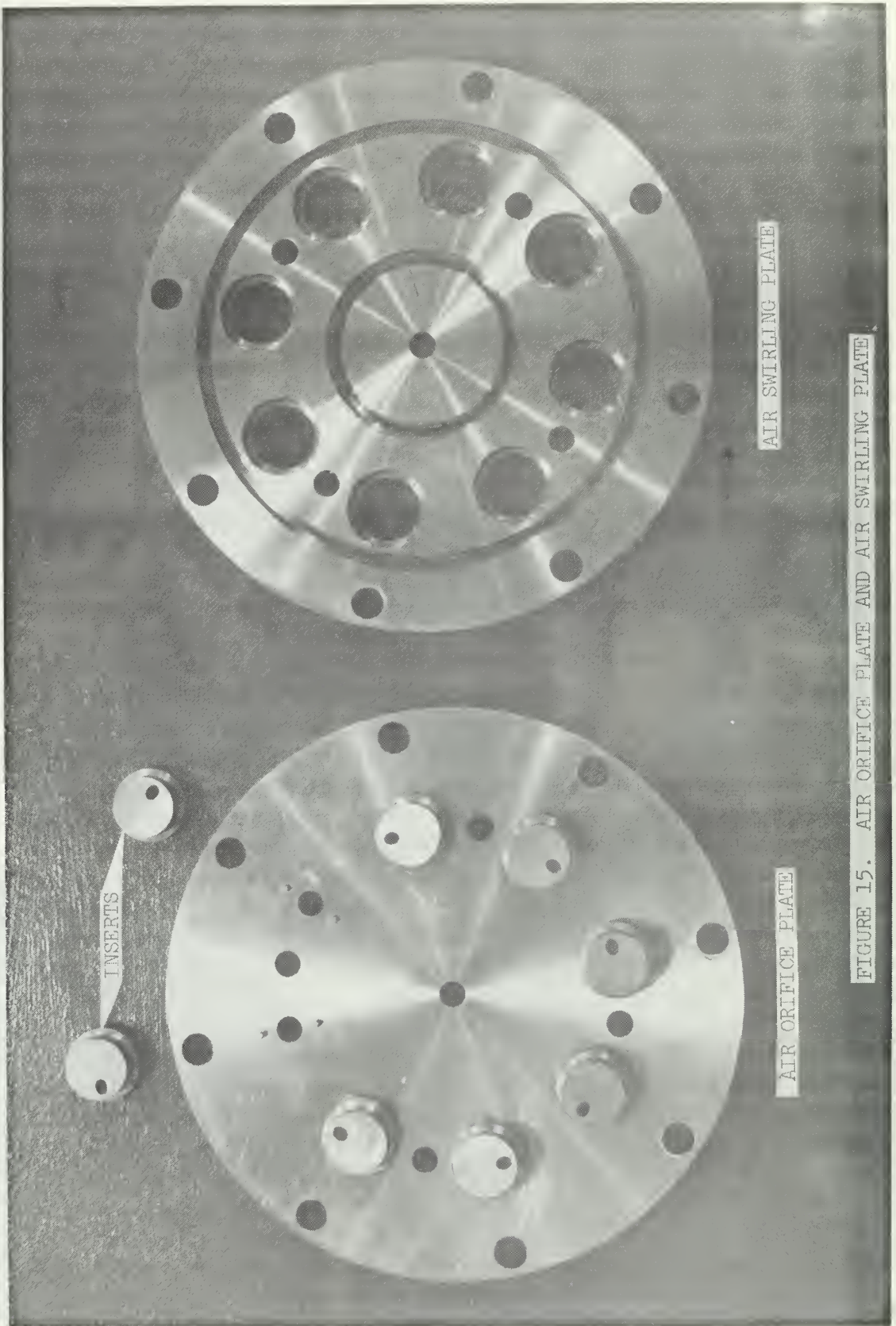

FIGURE 14. AIR INJECTOR MANIFOLD



AIR SWIRLING PLATE

AIR ORIFICE PLATE

INSERTS

FIGURE 15. AIR ORIFICE PLATE AND AIR SWIRLING PLATE

The center hole of the air orifice plate was subsequently enlarged to provide better air and fuel mixing. The air swirling plate was also modified by enlarging the center hole and bevelling the side near the combustion chamber at an angle of 45 degrees. A drawing of the air swirling plate incorporating these changes is shown in Fig. 16. The inserts, also shown in Fig. 16, were designed with changes in flow direction of 20, 30 and 40 degrees to the motor's axial centerline in order to vary the direction of the peripheral velocity. Small pins on the air orifice plate kept the inserts aligned in the proper position. The completed combination of the orifice and swirling plates prior to the center hole modification is shown in Fig. 17.

Figure 18 shows the rocket body. It contains windows that can be used to take pictures of the combustion process or can be covered when pictures are not desired. Openings are also provided for an igniter and a photocon. The combustion chamber was $5 \frac{9}{16}$ inches long with a diameter of four inches.

The mixture in the combustion chamber was ignited by a methane-oxygen torch with a spark provided by a 15,000 volt source. This spark jumped from the nichrome wire at the center of the igniter to the outer body. A cross-section drawing of this igniter is shown in Fig. 19 and a photograph of it in Fig 20. The igniter was extinguished at approximately 75 per cent of the expected chamber pressure by a pressure switch.

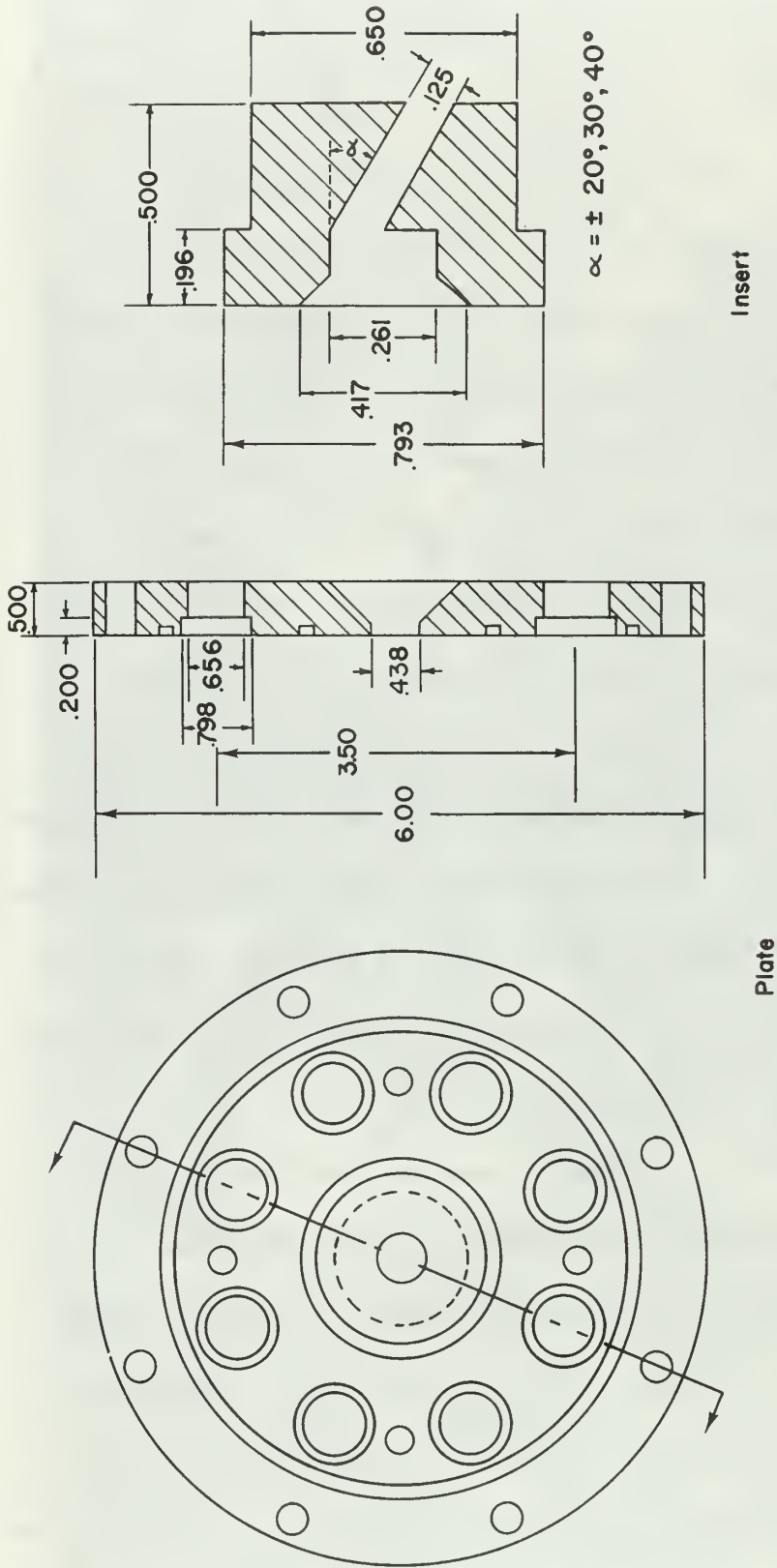

FIGURE 16.

AIR SWIRLING PLATE AND INSERT

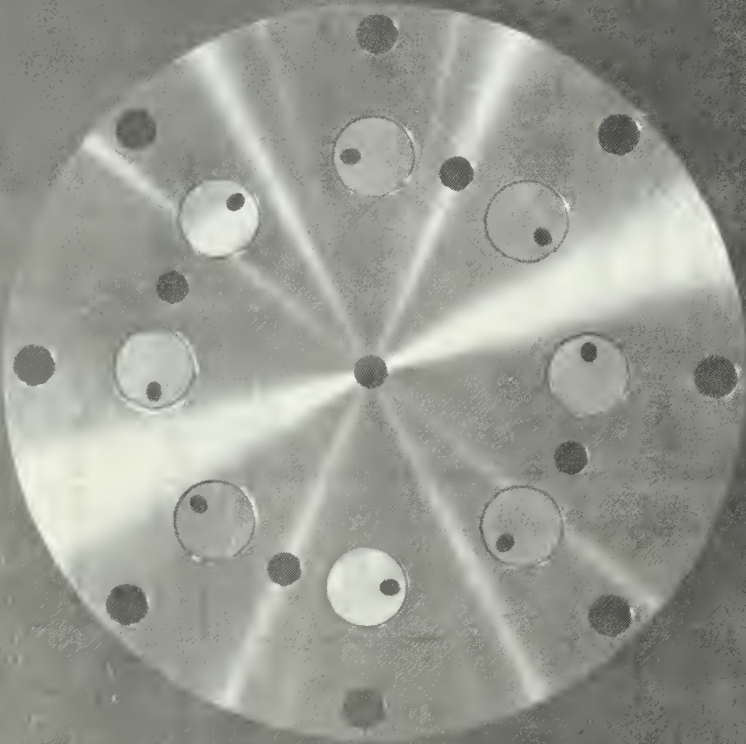

FIGURE 17. COMPLETED ASSEMBLY OF ORIFICE AND SWIRLING PLATES

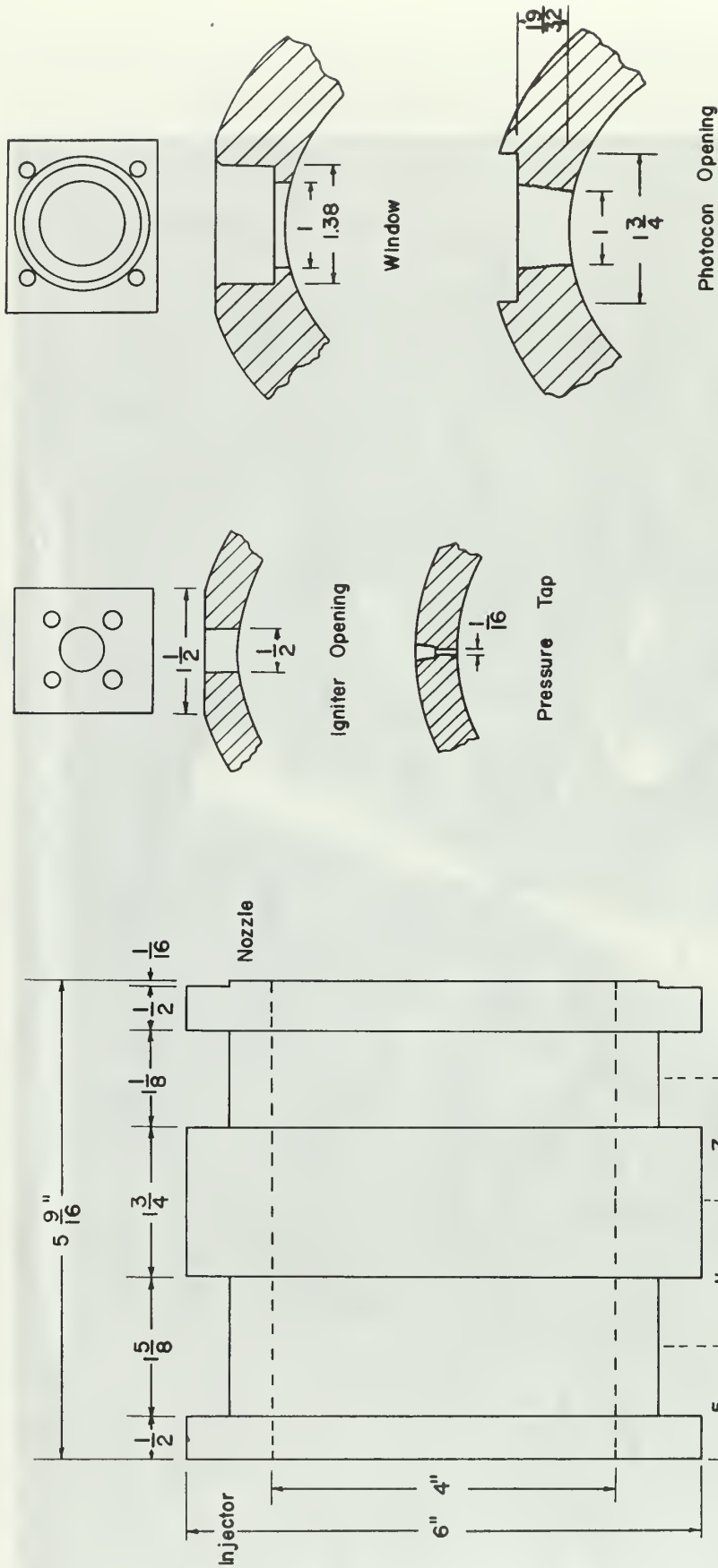
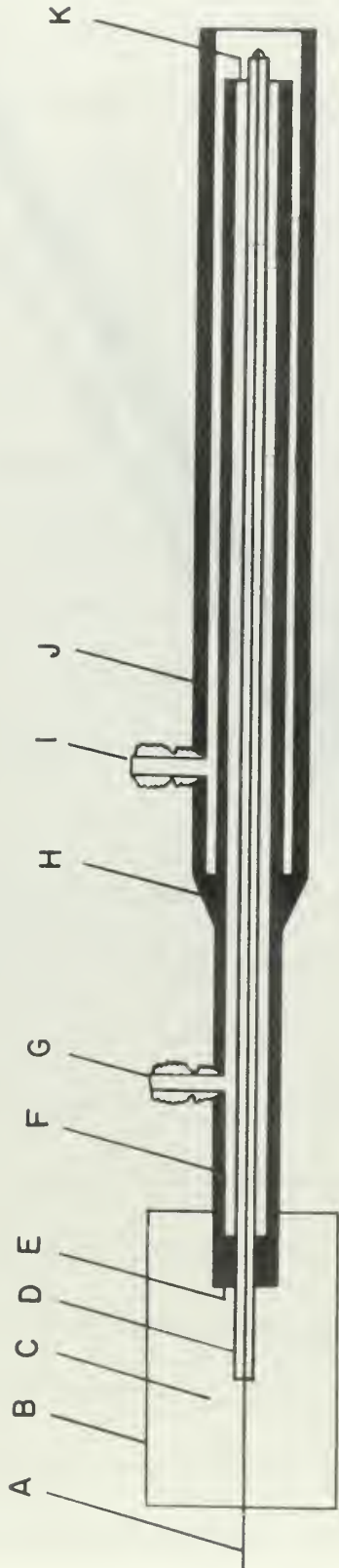

FIGURE 18.

ROCKET BODY

(θ Measured Clockwise From Top As Viewed From Injector)



- A: Nichrome Wire
- B: Plexiglass Tube
- C: Epoxy Insulator
- D: Mullite Insulator Bead
- E: Phenolic Retainer
- F: Fuel Tube

- G: Methane Fitting
- H: Weld
- I: Oxygen Fitting
- J: Oxygen Tube
- K: Epoxy Retainer

FIGURE 19. IGNITER

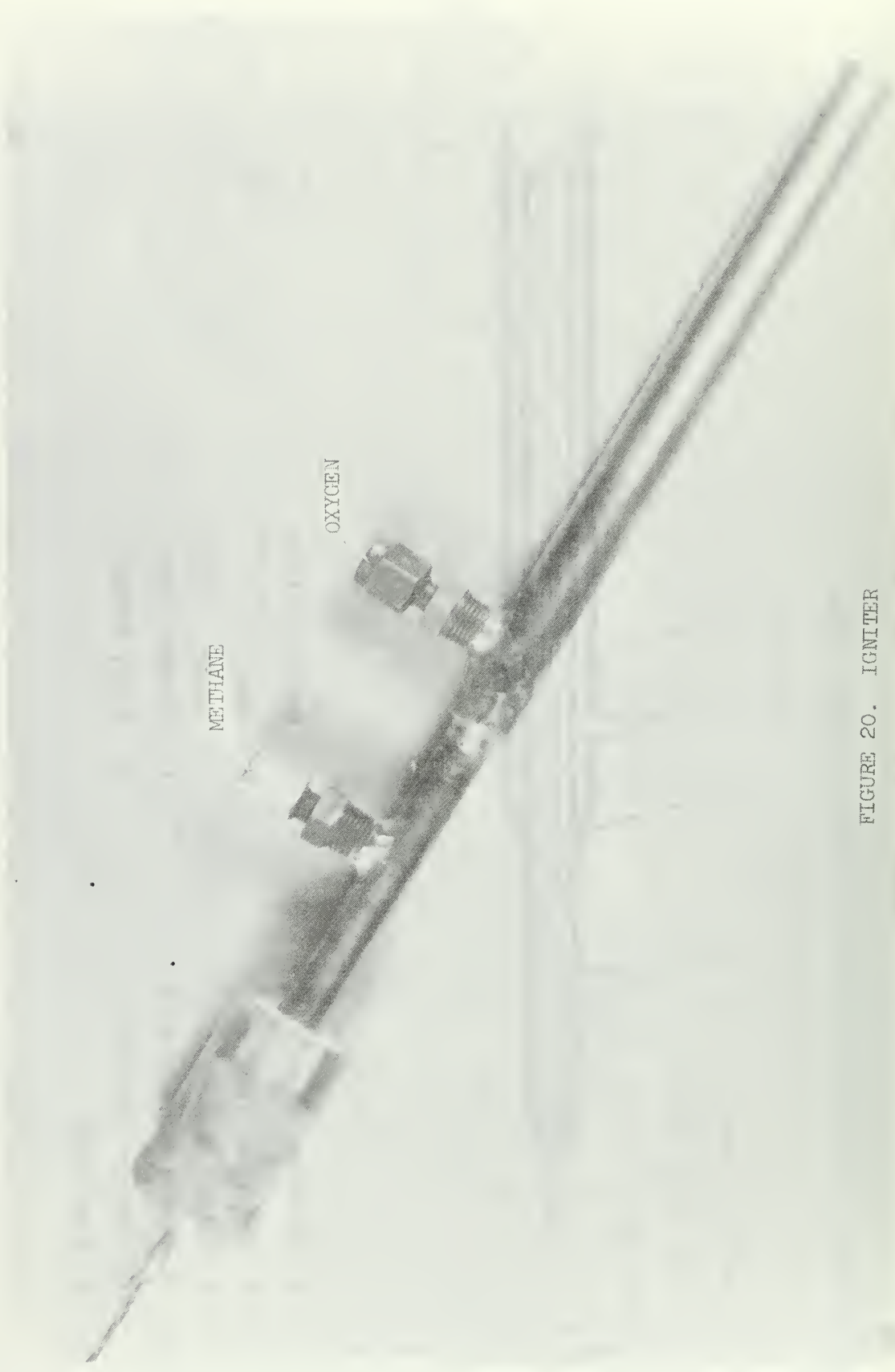

FIGURE 20. IGNITER

The nozzle, pictured in Fig. 21, was bolted to the rocket body. This nozzle was made as a separate item for ease in construction and so that different nozzles could be used on the rocket motor.

The assembled rocket motor on the thrust stand is shown in Figs. 22 and 23.

All pressures were recorded on a Honeywell 1508 Visicorder Oscillograph. This included primary and secondary air pressures and orifice differential pressures, fuel venturi pressure, air and fuel manifold pressures and two chamber pressures. Table 1 shows the type of transducer used for measuring these pressures. Each transducer was calibrated using an Amthor dead weight tester. The instrumentation including the visicorder oscillograph, power supplies, amplifiers and other related equipment is shown in Fig. 24.

Temperatures were obtained upstream of the air orifice using a copper versus constantan thermocouple and a Leeds and Northrup recorder. This recorder was calibrated by supplying known voltages to the thermocouple lead wires and recording the output.

The oscillatory pressure in the combustion chamber was measured with a Photocon Model 352A transducer. This transducer was calibrated with a dead weight tester. The pressure variation from the Photocon was recorded on an Ampex CP-100 magnetic tape recorder at 60 inches per second. A one volt rms, 4000 hz. signal was recorded on tape for a reference voltage and frequency.

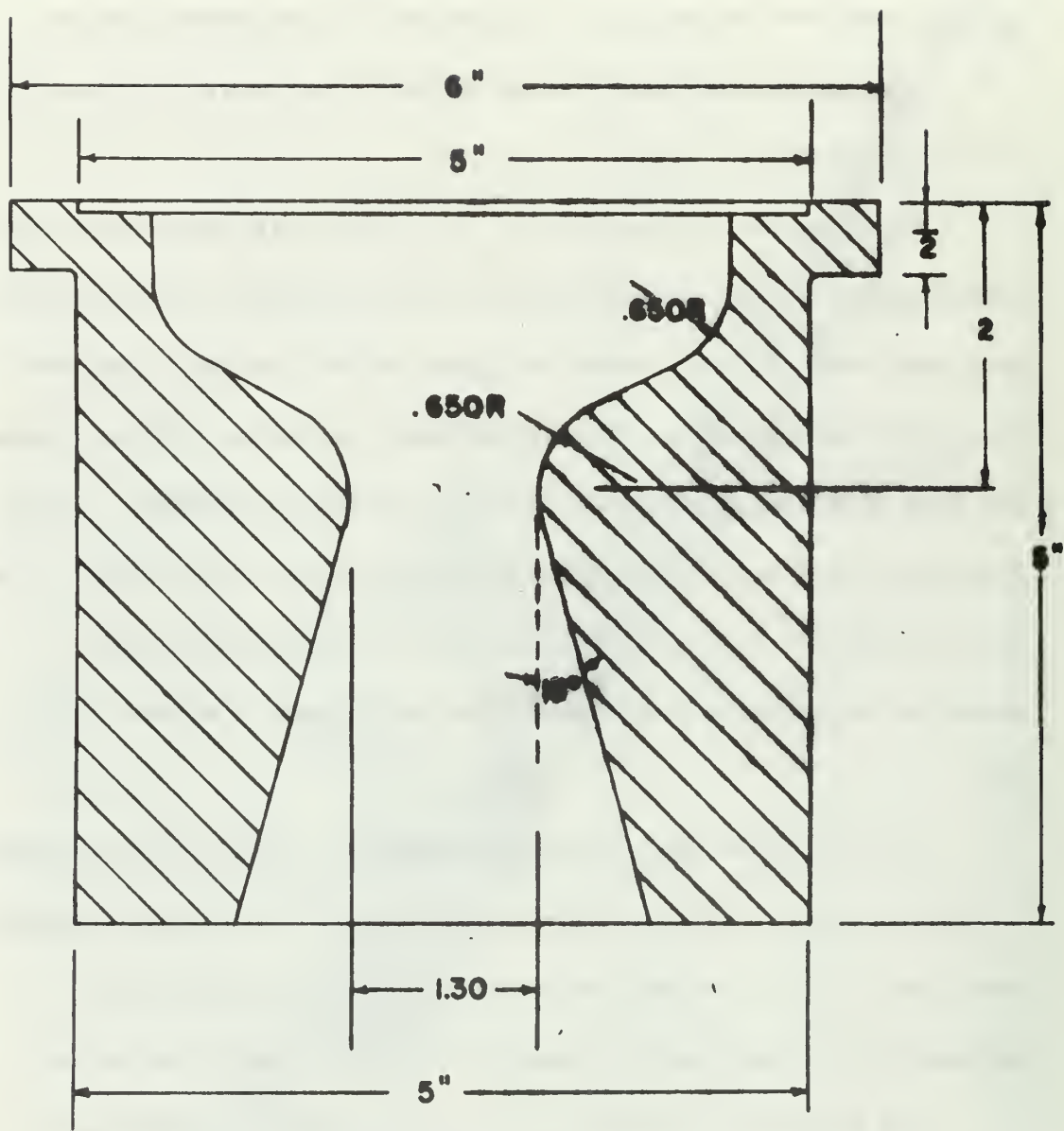

FIGURE 21.
NOZZLE

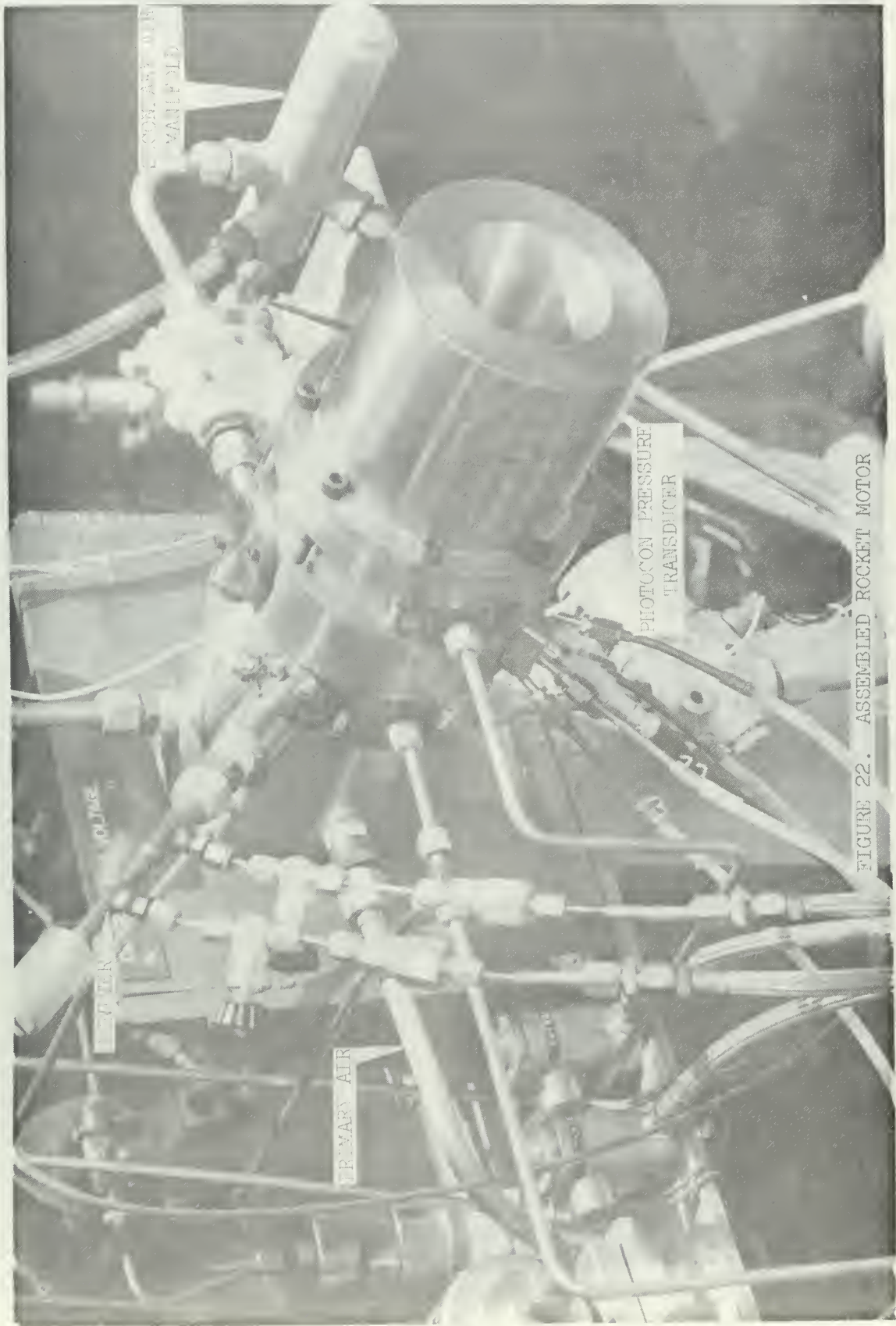

FIGURE 22. ASSEMBLED ROCKET MOTOR

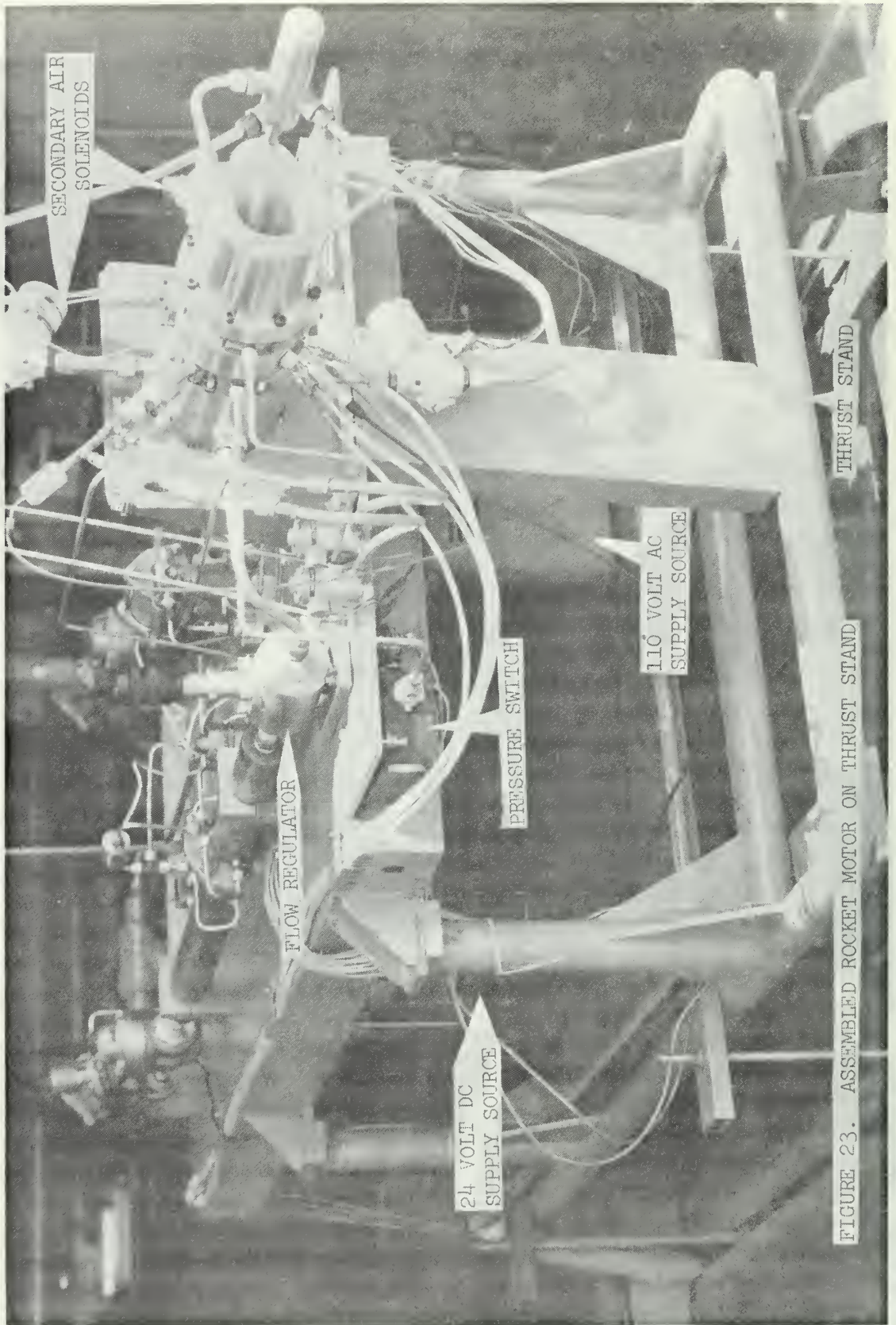

FIGURE 23. ASSEMBLED ROCKET MOTOR ON THRUST STAND

Table I Summary of Instrumentation

<u>Parameter</u>	<u>Type of Transducer</u>
1. Primary Air Pressure	Teledyne Pressure Transducer
2. Secondary Air Pressure	Teledyne Pressure Transducer
3. Steady-state Chamber Pressure	Teledyne Pressure Transducer
4. Venturi Pressure	Teledyne Pressure Transducer
5. Fuel Manifold Pressure	Teledyne Pressure Transducer
6. Steady-state Chamber Pressure	Wiancko Pressure Transducer
7. Air Manifold Pressure	Wiancko Pressure Transducer
8. Primary Air Orifice Differential Pressure	Wiancko Differential Pressure Transducer
9. Secondary Air Orifice Differential Pressure	Wiancko Differential Pressure Transducer
10. Chamber Oscillatory Pressure	Photocon Model 352A Pressure Transducer

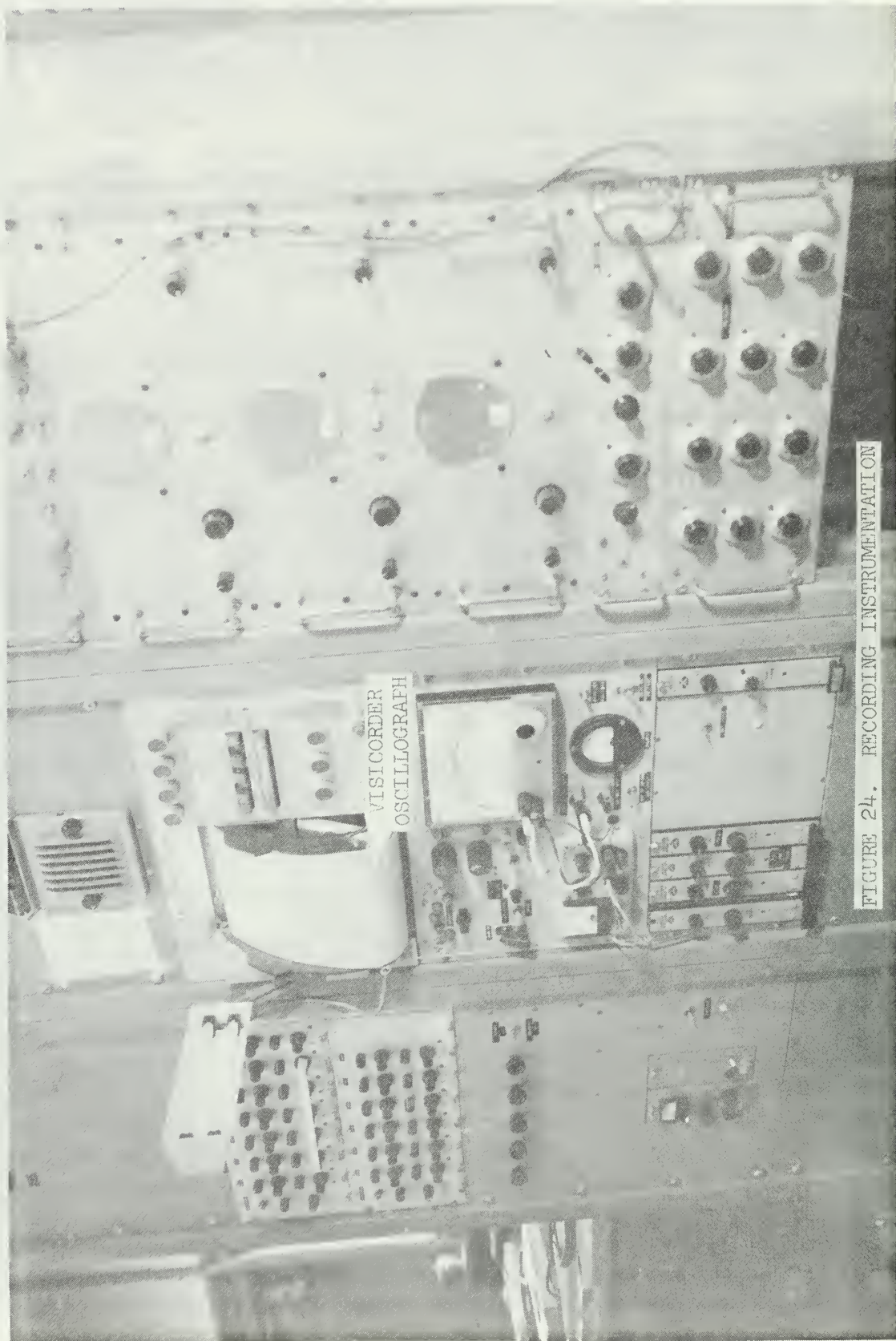
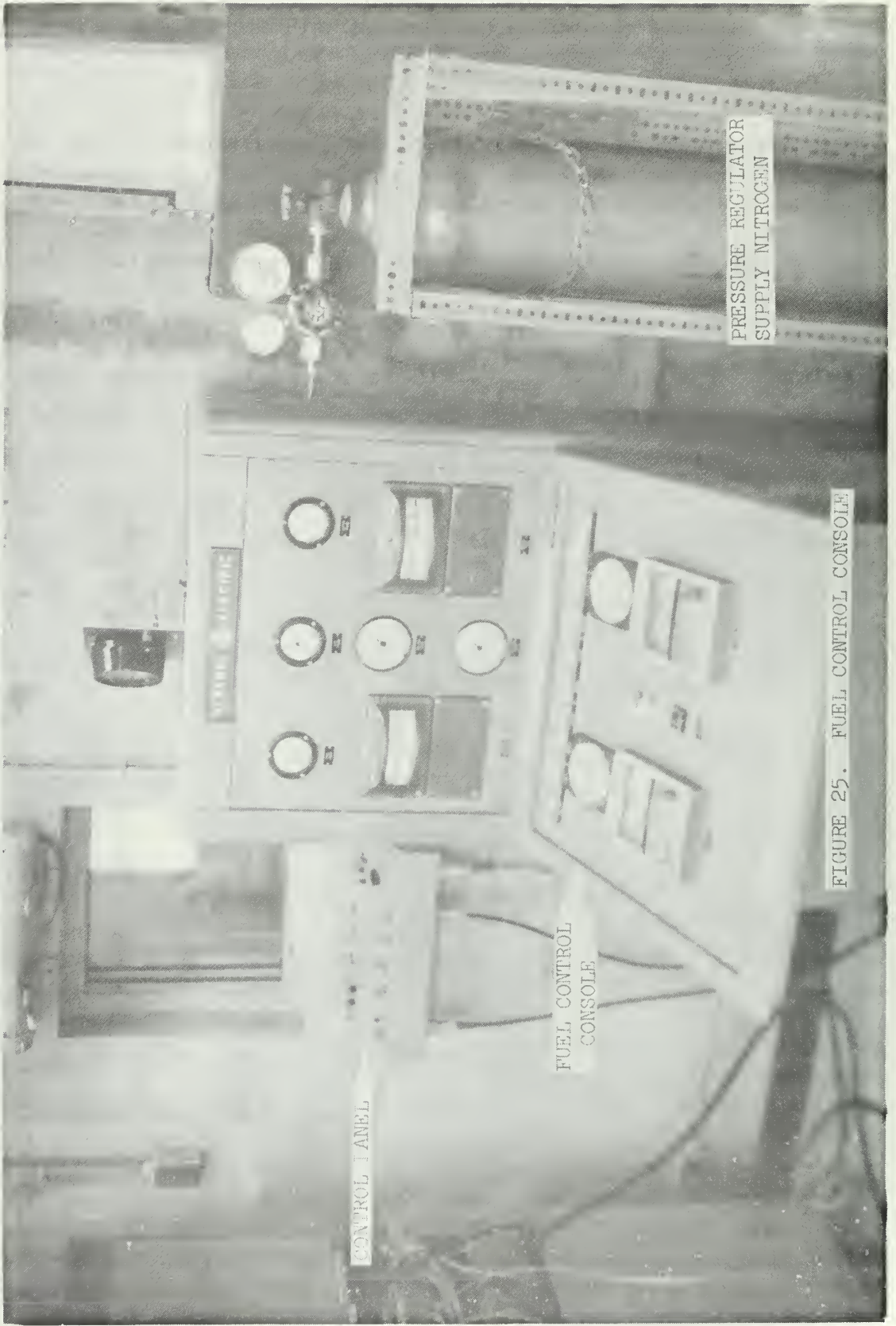

FIGURE 24. RECORDING INSTRUMENTATION

After the termination of a run the pressure recording was played back into the visicorder oscillograph at $1 \frac{7}{8}$ inches per second. The frequency and amplitude of the combustion instability were determined from this trace.

The fuel was controlled from the console shown in Fig. 25. Before each firing the fuel system was pressurized to the on-off valve actuator in the test cell. All firings were controlled from the control panel, shown in Fig. 26, which was located in front of a window to the rocket test cell. From this position a clear view of the firing area could be maintained.



PRESSURE REGULATOR
SUPPLY NITROGEN

FIGURE 25. FUEL CONTROL CONSOLE

FUEL CONTROL
CONSOLE

CONTROL LABEL

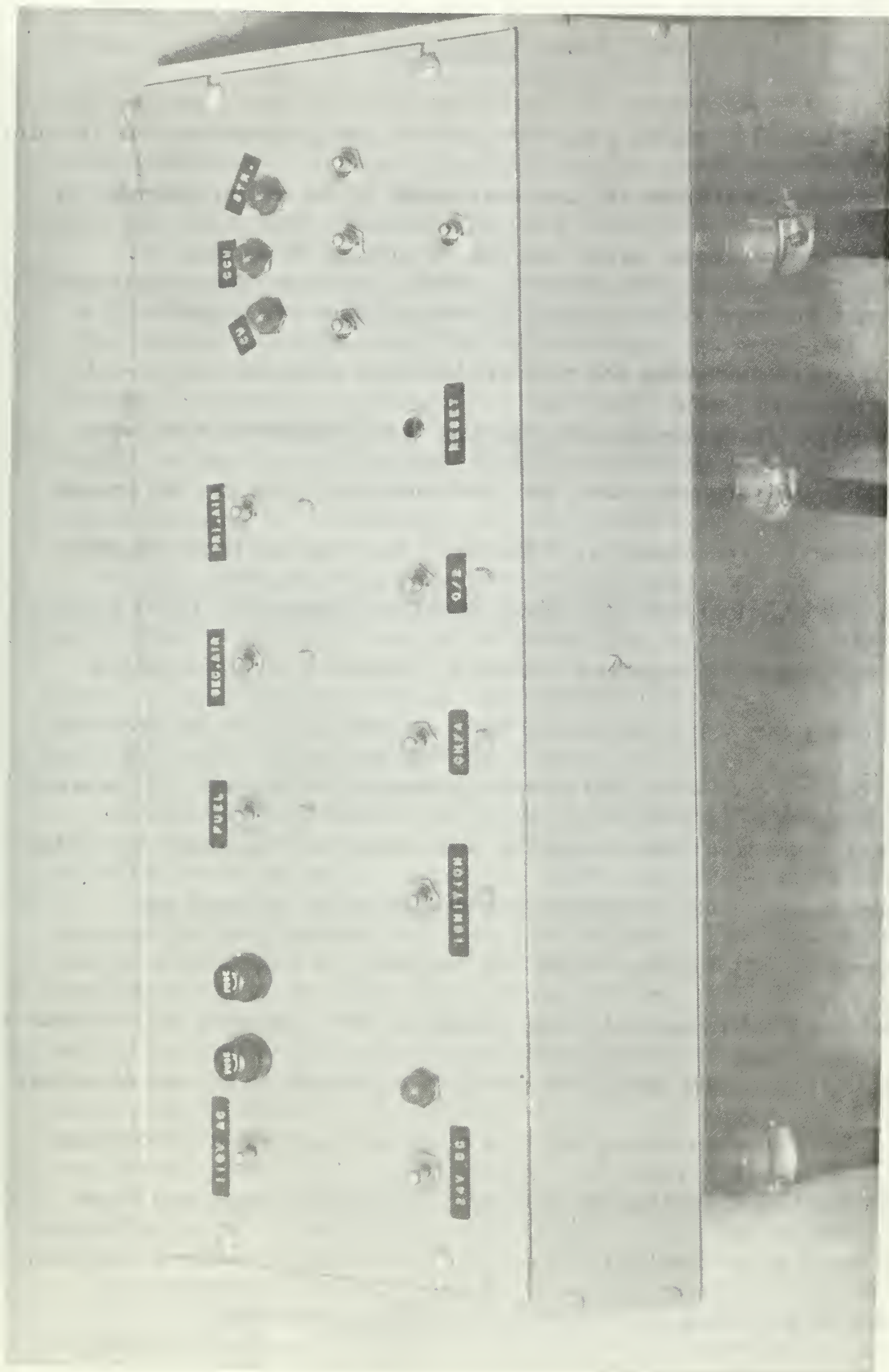

FIGURE 26. CONTROL PANEL

V. RESULTS

Table II presents a summary of the data obtained for the 18 valid runs made. A number of runs were made in the initial attempts to fire the rocket motor which are not included in these results. Omitted also are runs in which the motor ceased firing prior to a full cycle of clockwise and counterclockwise secondary air swirl.

With the secondary air inserts set at 20 degrees runs were made varying the secondary air flow rate from .224 to .568 pounds per second. The direction of the swirl was changed from counterclockwise to clockwise (as viewed from the injector) in some runs and this sequence reversed in others. When the direction of the secondary air swirl was varied from counterclockwise to clockwise the rocket motor exhibited a marked tendency to either: (1) develop a first tangential mode instability and remain in this mode with little change in pressure amplitude when the direction of swirl was changed; or (2) initially display no frequency of instability and then develop a first tangential mode instability with a significant increase in maximum pressure amplitude when the clockwise swirl was selected.

When the secondary air flow direction was initially clockwise an instability exhibiting the frequency of the first tangential mode was found which changed to a random instability of reduced maximum pressure amplitude when switching to counterclockwise.

The secondary air flow rate was varied from .333 to .568 pounds per second with 40 degree inserts installed in the rocket motor. All runs were made with the secondary air initially swirling counterclockwise. In these runs there was no identifiable frequency and small maximum pressure amplitude with the secondary air swirling counterclockwise. When the swirl was changed to clockwise a first tangential mode instability developed and the pressure amplitude increased significantly. These were essentially the same tendencies found with 20 degree inserts but with 40 degree inserts the results were more pronounced and more consistent.

At the higher secondary air flow rates there was a tendency for the combustion process to be quite stable with no definite instability trends. This condition existed regardless of the direction of secondary air swirl or angle of the inserts.

An attempt was made to correlate the tangential velocity of the secondary air flow entering the combustion chamber with the magnitude of the chamber pressure oscillations. This velocity was determined using the continuity equation and the angle of the particular insert being used. Very little correlation was found except that the effect of the direction of swirl was much more pronounced when the 40 degree inserts were used; that is, when the tangential velocity was a larger percentage of the total velocity.

A typical trace of the visicorder oscillograph readout of the pressure transducers is shown in Fig. 27. The chamber pressures

Table II Summary of Data

Run	Direction of Swirl	Initial Secondary Air Flow Angle (degrees)	Secondary Air Flow Rate (lb/sec)	Secondary Air Tangential Velocity (in/sec)	Chamber Pressure (psia)	Fuel Flow Rate (lb/sec)	Mixture Ratio	Maximum Pressure Amplitude (psi)	Frequency of Instability (hz)
1	CCW	20	.224	365	257	.167	13.57	26.9	5100
	CW	20	.254	406	262	.166	13.80	21.4	5100
2	CCW	20	.240	381	264	.174	13.73	22.5	NONE
	CW	20	.274	427	269	.173	13.96	40.5	5200
3	CCW	20	.245	392	262	.173	13.49	54.9	5300
	CW	20	.263	417	265	.172	13.64	28.5	5300
4	CCW	20	.261	438	250	.156	14.52	25.4	5100
	CW	20	.273	448	256	.155	14.63	40.0	5100
5	CCW	20	.316	532	249	.175	14.68	31.4	5300
	CW	20	.316	495	268	.175	14.68	26.0	5300
6	CCW	20	.317	504	264	.179	14.50	28.9	5100
	CW	20	.317	496	268	.179	14.50	20.4	5200
7	CCW	20	.326	532	257	.177	14.54	20.0	NONE
	CW	20	.326	514	266	.177	14.54	27.4	5200
8	CW	20	.341	572	250	.184	12.79	37.5	5200
	CCW	20	.341	579	247	.183	12.83	21.9	NONE(1)
9	CCW	20	.366	561	273	.175	14.29	19.0	NONE
	CW	20	.387	584	278	.174	14.48	36.4	5200
10	CW	20	.445	695	268	.183	14.52	35.5	5100
	CCW	20	.445	695	268	.183	14.52	24.9	NONE(1)
11	CCW	20	.450	689	274	.179	15.09	17.0	NONE
	CW	20	.450	689	274	.178	15.14	19.0	NONE(1)
12	CW	20	.558	833	281	.185	14.38	23.9	NONE(1)

Table II (cont'd)

Run	Direction of Swirl	Initial Secondary Air Flow Angle (degrees)	Secondary Air Flow Rate (lb/sec)	Secondary Air Tangential Velocity (in/sec)	Chamber Pressure (psia)	Fuel Flow Rate (lb/sec)	Mixture Ratio	Maximum Pressure Amplitude (psi)	Frequency of Instability (hz)
13	CCW	20	.558	833	281	.185	14.38	20.0	NONE
	CCW	20	.568	832	286	.183	15.54	17.0	NONE
14	CW	20	.568	832	286	.182	15.58	21.5	NONE(1)
	CCW	40	.333	992	265	.177	14.52	18.5	NONE
15	CW	40	.333	982	267	.177	14.52	35.0	5000
	CCW	40	.345	1022	266	.178	14.54	18.0	NONE
16	CW	40	.345	1018	267	.178	14.54	31.0	5300
	CCW	40	.389	1147	267	.177	14.88	22.2	NONE
17	CW	40	.389	1142	269	.177	14.88	23.7	5200
	CCW	40	.436	1249	275	.180	14.97	27.8	NONE
18	CW	40	.436	1240	277	.179	15.01	38.6	5300
	CCW	40	.568	1577	284	.178	15.80	28.9	NONE
	CW	40	.568	1577	284	.178	15.80	25.5	NONE

(1) No pronounced frequency of instability occurred although there was an attempt to be unstable at 5200 hz.

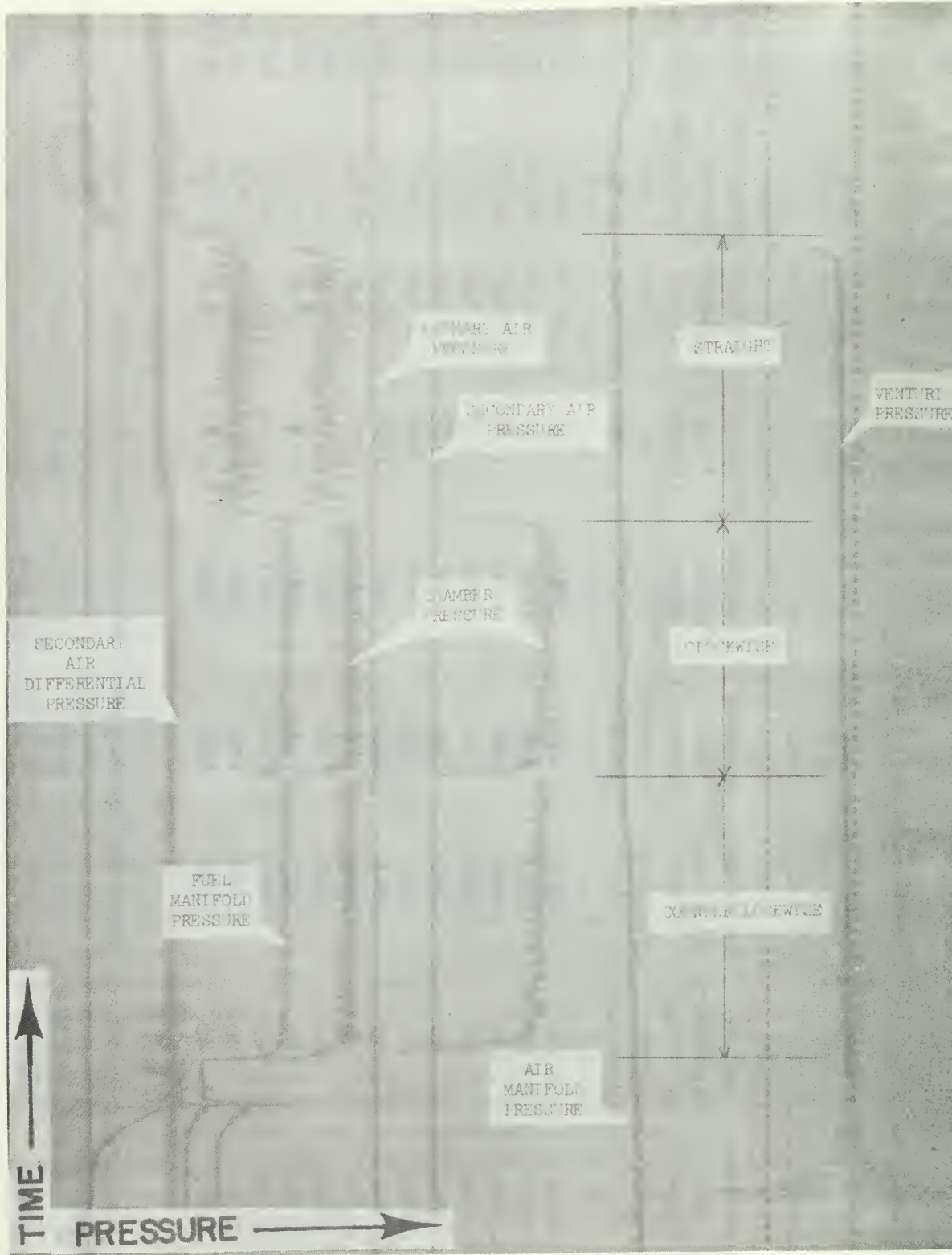

FIGURE 27. VISICORDER OSCILLOGRAPH DATA

shown are steady-state values. Figure 28 shows a trace of the oscillatory pressure from the photocon. The bottom portion of this trace shows the initial recording with the oscillograph operating at 0.1 inches per second. This was done in order to view the entire run. The pressure was then recorded at 80 inches per second for the portions of the run for which the pressure amplitude and frequency were desired. A typical pressure trace exhibiting a first tangential mode instability with the oscillograph operating at 80 inches per second is shown in the upper portion of Fig. 28.

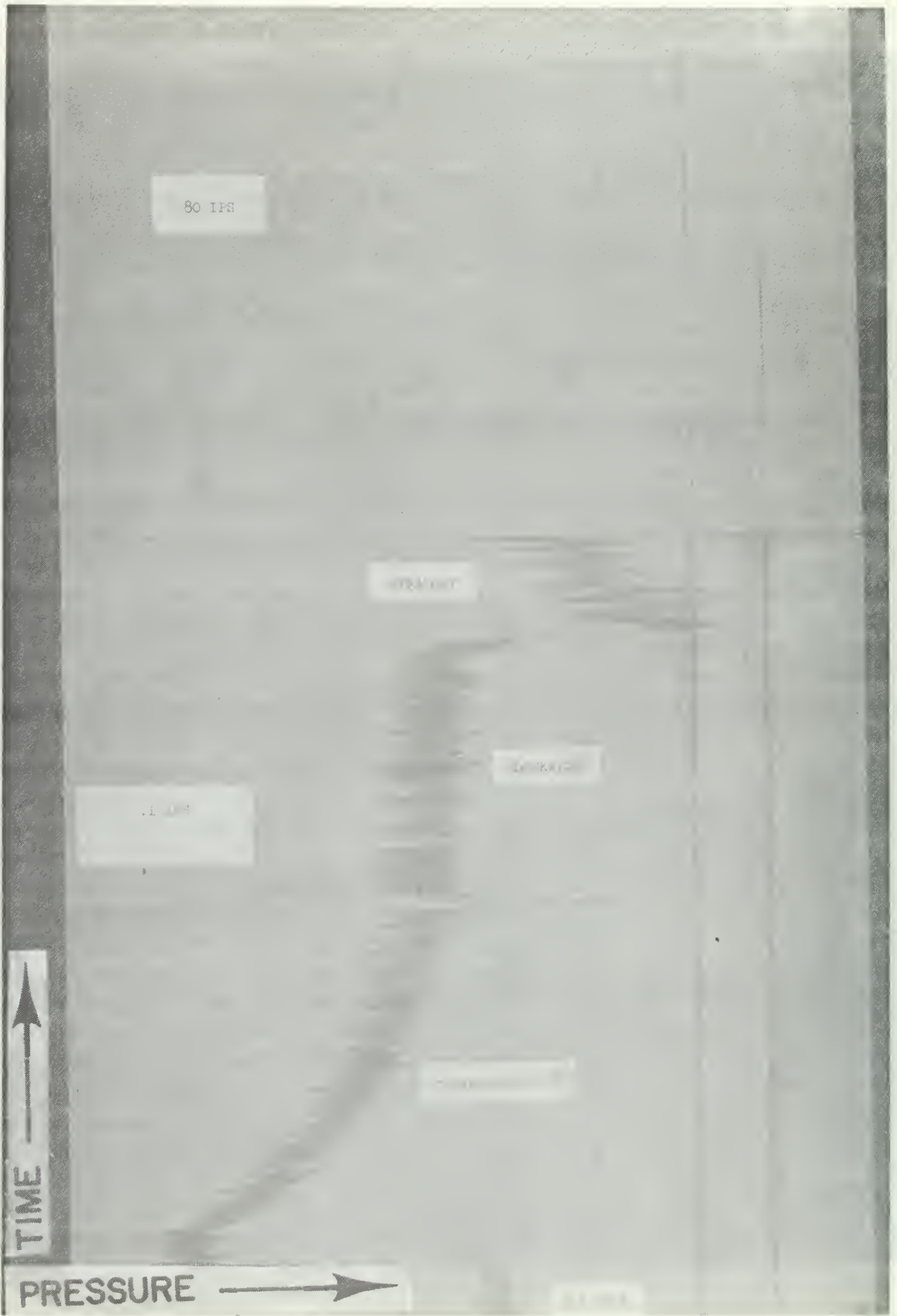

FIGURE 28. OSCILLATORY PRESSURE FROM PHOTOCOM

VI. DISCUSSION OF RESULTS

All of the identifiable modes of combustion instability determined were first tangential. The theoretical frequency for this mode varied slightly with the mixture ratio but was about 5200 hertz. The first tangential mode was easily distinguished from the first radial and first longitudinal modes because of the geometry of the combustor. The first radial and longitudinal modes occurred at approximately 10,800 and 3200 hertz, respectively.

Initially it was planned to start the rocket motor with the secondary air in the straight mode of operation and then switch to counterclockwise and clockwise swirl to find the effect this swirl had on stability. Without the secondary air swirling, however, the motor was extremely inefficient and was very difficult to start. Even when the motor started the combustion was so poor that when a different mode of secondary air was selected, it usually extinguished. The next attempted firing cycle was counterclockwise swirl, straight, then clockwise swirl. Using this sequence the motor usually fired, but still would not sustain combustion when the interruption of flow occurred during the switching cycle. It was subsequently found that a combination of swirling and straight secondary air flow provided the necessary mixing for proper combustion. Furthermore the direction of the swirl could be changed without significant interruption of the combustion process. The optimum firing sequence

then was to start the motor with a combination of swirling and straight secondary air and then switch the direction of the swirl while the straight flow remained the same. It was this method that was used for all of the firings. When both swirls were discontinued and only a straight secondary air flow maintained, the motor would only fire part of the time and then at a greatly reduced chamber pressure. Thus the non-swirling mode of secondary air flow could not be used to obtain any meaningful data.

The results indicate that a vortex flow in the combustion chamber had a significant effect on combustion instability as theoretically predicted in Ref. 3. The most predominant tendency was for the combustion process to become more unstable when the secondary air swirl was changed from counterclockwise to clockwise and become more stable when this sequence was reversed. This also substantiated the postulation of Heidmann and Feiler [Ref. 6] that a vortex flow in one direction would decrease instability while a flow in the opposite direction would increase it.

Three of the runs at low secondary air flow rates and 20 degree inserts developed an initial instability and maintained it at approximately the same maximum pressure amplitude when the direction of the secondary air flow was changed. Thus there was a tendency for the swirling secondary air to lose its effect at small vortex flows.

Run three displayed an unusual characteristic in that the initial counterclockwise swirl caused a first tangential mode instability of high maximum pressure amplitude and this pressure amplitude decreased significantly when the swirl was changed to clockwise. This was the only run in which this peculiarity occurred and must be considered an anomaly.

Four of the runs at higher secondary air flow rates exhibited a tendency to remain fairly stable throughout the run. Although there was a pressure variation no pronounced frequency of instability occurred. This occurred with both 20 and 40 degree inserts. This indicates that there may be an upper threshold above which the vortex flow loses its tendency to affect combustion instability.

The attempt to correlate the tangential velocity of the secondary air flow entering the combustion chamber with the magnitude of the chamber pressure oscillations met with little success. Reference 3 predicted that as the vortex velocity increased, a decreasing burning rate parameter would be required to cause the combustion process to become unstable. This information is presented in Fig.3. This burning rate parameter is a function of the average burning rate of propellant per length of combustor which was unknown in the current investigation. The burning rate parameter can be calculated at various positions along the combustor axis for given and estimated conditions in the combustion chamber. These estimations can currently be found through the use of a computer program [Ref. 11] but lack of time precluded their use in the present study.

The tangential velocity listed in Table II and described above was a rather dubious parameter. It merely indicated the tangential portion of the velocity with which the secondary air initially entered the combustion chamber. The determination of the effect of this velocity on the mixture in the combustor would have been very difficult using a momentum balance. The tangential velocity actually generated within the combustor could be ascertained most accurately using streak photography [see Ref. 5] or a similar technique. The rocket motor used in this investigation has ports available for photographic equipment.

Throughout the runs there was a considerable amount of combustion noise associated with the chamber pressure. This noise amounted to as much as 10 per cent of the chamber pressure and often caused uncertainty as to whether a change in stability characteristics had occurred when the direction of the secondary air swirl was switched. The combustion noise was caused by the inefficiency of the combustion process which was a direct result of an injector design that was not optimum. This inefficiency reached a critical stage when the secondary air was flowing in the straight mode only. In this form of operation the motor would fire only part of the time. When it did fire the chamber pressure averaged about 60 per cent of the value obtained with a combination of straight and swirling secondary air. This inefficiency was further substantiated by the low value of the characteristic exhaust velocity C^* occurring. With the combination of secondary air flow C^* was about 99 per cent

of the theoretical value [Ref. 11]. Since C^* is directly proportional to the chamber pressure it was about 60 per cent of the theoretical value when the secondary air was flowing straight.

This inefficiency and correspondingly low chamber pressure prevented worthwhile data when the rocket motor was firing with the secondary air flowing straight only. Since the chamber conditions changed so drastically between this straight flow and when the secondary air was swirling, it was impossible to determine whether a change in stability conditions was due to the vortex flow produced or to the more efficient combustion process realized.

To obtain optimum results from this rocket motor the injector design would have to be changed to produce an equally efficient combustion process under all methods of operation. A possible solution to this problem would be a multi-element injector which would provide better atomization of the fuel.

In order to accurately assess the effect of propellant tangential velocity on stability limits all other variables which affect this stability must be held constant. These variables include fuel mass mean drop size, fuel flow rate and mixture ratio [Ref. 11]. The fuel mass mean drop size is proportional to the ratio of fuel momentum to oxidizer momentum. Thus there must be precise control over the primary air, secondary air and fuel flow rates. Although this was attempted in the present study, equipment limitations prevented accurate control of the desired run conditions.

The primary air supply varied significantly with the pressure available in the air supply tanks. Since the supply tank pressure decreased during each run and the compressor took a considerable period of time to re-pressurize the tanks, low primary air pressure was a continuing problem. Primary air flow rate was thus affected since it was directly proportional to air pressure.

The secondary air supply pressure varied to a small extent with air supply tank pressure but the main problem with the secondary air flow rate was the inability to accurately set the hand-operated flow regulator valve. Ideally both primary and secondary air could have been run prior to an actual firing and then adjusted until the desired total air flow was realized. This would have reduced the air supply tank pressure, however, and compounded the problem previously mentioned.

The desired fuel flow rate was also difficult to obtain since the nitrogen supply pressure controlling the fuel was extremely difficult to set precisely and had a tendency to vary from the initial value.

Throughout this investigation it was tacitly assumed that when a first tangential mode instability developed, its direction of propagation remained the same for the entire run. Thus if the wave began spinning in a clockwise direction, a secondary air flow in the counterclockwise direction would be expected to damp the wave. Upon switching to clockwise secondary air flow the wave would be reinforced and the instability increased. But if the momentary interruption of combustion that occurred when the secondary air

flow was switched caused the wave to change direction, a completely erroneous indication would be obtained. This problem area could be eliminated by installing one or two more photocons around the periphery of the rocket motor. Comparing the frequency of the wave with the distance between photocons would eliminate the uncertainty of the direction of wave propagation. This procedure would also verify that when combustion instability had been decreased the swirling air flow was in a direction opposite to the wave.

In analyzing the frequency of the instabilities a small portion of the run was viewed with the visicorder operating at 80 inches per second. This rapid speed made it impractical and uneconomical to view but a small part of the pertinent trace. Although the entire run was viewed at .1 inches per second initially for an overall presentation of the combustion process it was impossible to pick a particular section of the run as the most representative or the section where the most information could be gained. This problem could be reduced substantially by digitizing the frequency data and using a digital computer to analyze the entire firing run in an attempt to determine the predominant frequencies.

The results obtained from this investigation were from a relatively small number of runs with a number of varying initial conditions. More runs and more precise control of the variables affecting stability limits must be obtained before the trends reported herein can be substantiated.

VII. CONCLUSIONS

A significant change in stability conditions was found when a vortex flow was generated within the combustion chamber of the rocket motor. A vortex flow in the counterclockwise (as viewed from the injector) direction tended to decrease the instability and a tendency to increase the instability was found when the swirl was clockwise. This tendency can only be considered valid for this particular rocket motor under the conditions in which the investigation was conducted.

The specific effect of the amount of tangential velocity within the combustor on the burning rate parameter required to produce instability was not determined due to the lack of photographic equipment for determining the tangential velocity and the lack of time to estimate the burning rate parameter. There was little correlation between the tangential velocity of the secondary air flow entering the combustion chamber and the magnitude of the chamber pressure oscillations.

The injector design of the rocket motor must be improved in order to reduce the combustion noise and allow more precise determination of chamber pressure variation. This improvement will also permit an investigation of the combustion stability when the secondary air is flowing straight and a comparison of this mode of operation with the swirling secondary air.

Photographic equipment should be installed in order to determine the tangential velocity of the mixture in the combustion chamber. The burning rate parameter of the combustion process could then be determined and correlated with the tangential velocity to define the stability limits under varying conditions.

Improvement of present equipment should also include better control of propellant flow rates, installation of additional photocons for more accurate wave propagation determinations and a better method of analyzing the instability trace on the visicorder oscillograph.

REFERENCES

1. Priem, Richard J. and Heidmann, Marcus F., Propellant Vaporization as a Design Criterion for Rocket-Engine Combustion Chambers, NASA TR R-67, 1960.
2. Priem, Richard J. and Guentert, Donald C., Combustion Instability Limits Determined by a Nonlinear Theory and a One-Dimensional Model, NASA TN D-1409, 1962.
3. Priem, Richard J., Influence of Combustion Process on Stability, NASA TN D-2957, 1965.
4. Heidmann, Marcus F., Oxygen-Jet Behavior During Combustion Instability in a Two-Dimensional Combustor, NASA TN D-2725, 1965.
5. Heidmann, Marcus F., Oscillatory Combustion of a Liquid-Oxygen Jet With Gaseous Hydrogen, NASA TN D-2753, 1965.
6. Heidmann, Marcus F. and Feiler, Charles E., Evaluation of Tangential Velocity Effects on Spinning Transverse Combustion Instability, NASA TN D-3406, 1966.
7. Sotter, J. George and Flandro, Gary A., "Resonant Combustion in Rockets," Scientific American, v. 219, p. 94-103, December, 1968.
8. Weiss, Richard R., An Introduction to Combustion Instability in Liquid Propellant Rocket Engines, AFRPL-TR-66-150, 1966.
9. Morse, P.M., Vibration and Sound, McGraw-Hill, 1958.
10. Scofield, M.P., A Generalized Thermochemistry Computer Program (to be published), Jet Propulsion Center, Purdue University, 1968.
11. Netzer, D. W., Investigation of Combustion Characteristics of a Bi-Phase Rocket, Ph.D. Thesis, Purdue University, 1968.
12. The American Society of Mechanical Engineers, Instruments and Apparatus, Chapter 4, Flow Measurement.

INITIAL DISTRIBUTION LIST

	No. Copies
1. Defense Documentation Center Cameron Station Alexandria, Virginia 22314	20
2. Library, Code 0212 Naval Postgraduate School Monterey, California 93940	2
3. Commander, Naval Air Systems Command Department of the Navy Washington, D. C. 20360	1
4. Asst Professor D. W. Netzer Department of Aeronautics Naval Postgraduate School Monterey, California 93940	1
5. LT Joseph A. Kiel, USN USS Hancock (CVA-19) Fleet Post Office San Francisco, California 96601	1

DOCUMENT CONTROL DATA - R & D

(Security classification of title, body of abstract and indexing annotation must be entered when the overall report is classified)

1. ORIGINATING ACTIVITY <i>(Corporate author)</i> Naval Postgraduate School Monterey, California 93940	2a. REPORT SECURITY CLASSIFICATION Unclassified <hr/> 2b. GROUP
--	---

3. REPORT TITLE
 An Investigation of the Effect of a Tangential Gas Velocity on Combustion Instability

4. DESCRIPTIVE NOTES *(Type of report and inclusive dates)*

5. AUTHOR(S) *(First name, middle initial, last name)*
 Joseph Alan Kiel

6. REPORT DATE June 1969	7a. TOTAL NO. OF PAGES 75	7b. NO. OF REFS 12
-----------------------------	------------------------------	-----------------------

8a. CONTRACT OR GRANT NO. b. PROJECT NO. c. d.	9a. ORIGINATOR'S REPORT NUMBER(S) <hr/> 9b. OTHER REPORT NO(S) <i>(Any other numbers that may be assigned this report)</i>
---	---

10. DISTRIBUTION STATEMENT
 Distribution of this document is unlimited

11. SUPPLEMENTARY NOTES	12. SPONSORING MILITARY ACTIVITY Naval Postgraduate School Monterey, California 93940
-------------------------	---

13. ABSTRACT

A small, uncooled research rocket motor was built to study the effects of a vortex flow on combustion instability. Normal heptane and air were used as propellants with the air being divided into two flows; a primary flow at the center of the combustion chamber and a secondary flow at the periphery of the chamber. The secondary air provided the swirl which could be directed clockwise or counterclockwise at various angles or a straight mode of operation. Runs were made at various flow rates with the direction of swirl changed during the run.

A first tangential high frequency mode of combustion instability was developed and a significant change in stability conditions was found when a vortex flow was generated within the combustion chamber. It was found that a swirl in one direction tended to decrease the instability while a flow in the opposite direction increased it.

14

KEY WORDS

LINK A

LINK B

LINK C

ROLE

WT

ROLE

WT

ROLE

WT

Key Words:

Bi-phase

Combustion

Gas

Instability

Liquid

Propellant

Rocket

thesK3976

An investigation of the effect of a tang



3 2768 002 11915 8

DUDLEY KNOX LIBRARY