



Calhoun: The NPS Institutional Archive
DSpace Repository

NPS Scholarship

Publications

1999

Orientation Tracking for Humans and Robots Using Inertial Sensors

Bachmann, E.R.; Duman, I.; Usta, U.Y.; McGhee, R.B.; Yun,
X.P.; Zyda, M.J.

Bachmann, E.R., Duman, I., Usta, U.Y., McGhee, R.B., Yun, X.P., and Zyda, M.J.,
“Orientation Tracking for Humans and Robots Using Inertial Sensors”, Proc. of 1999
International Symposium on Computational Intelligence in Robotics and Automation,
Monterey, CA, December, 1999, pp. 187-194.

<https://hdl.handle.net/10945/41542>

This publication is a work of the U.S. Government as defined in Title 17, United
States Code, Section 101. Copyright protection is not available for this work in the
United States.

Downloaded from NPS Archive: Calhoun



Calhoun is the Naval Postgraduate School's public access digital repository for
research materials and institutional publications created by the NPS community.
Calhoun is named for Professor of Mathematics Guy K. Calhoun, NPS's first
appointed -- and published -- scholarly author.

Dudley Knox Library / Naval Postgraduate School
411 Dyer Road / 1 University Circle
Monterey, California USA 93943

<http://www.nps.edu/library>

Orientation Tracking for Humans and Robots Using Inertial Sensors

E. R. Bachmann, I. Duman, U. Y. Usta, R. B. McGhee, X. P. Yun, M. J. Zyda

Naval Postgraduate School, Monterey, CA 93943

E-mail: bachmann@cs.nps.navy.mil

Abstract

Joint angle determination for robots with flexible links can be difficult. Inertial orientation tracking combined with RF positioning provides an accurate method for determining end effector orientation and location. The same technology could also be used to determine human posture for the purpose of inserting humans in synthetic environments. Orientation filters based upon Euler angles suffer from singularities. This paper describes the design, implementation, and preliminary testing of an inertial tracking system using a “complementary” filter based upon quaternions. This filter is capable of tracking a rigid body through all orientations and is more efficient than those based on Euler angles. Results of qualitative tests of a prototype inertial angle tracking device are presented.

Background

Precise control of a robot manipulator requires accurate determination of end effector location and orientation. Due to link flexing and bending, this is often difficult. This problem could be solved using a hybrid inertial tracking technology currently being developed at the Naval Postgraduate School for the purpose of inserting humans into a networked synthetic environment (SE). The location and orientation of an end effector could be ascertained in the same way as the body posture of a tracked human. Just as the body posture of the tracked human could be used to precisely control the visual and audio queues of given to a user of a SE, so too could the orientation and location of an end effector be used to precisely control a robot manipulator.

Tracking systems currently in widespread use include optical, magnetic, and acoustic systems [19]. These systems typically have fairly high latency, marginal accuracy, moderate noise levels, shadowing problems, and limited range. The primary reason for most of these problems is the dependence of these systems on a transmitted “source” to determine orientation and location information. This source may be transmitted by body based beacons or received by body based sensors. Either way, limited range, shadowing problems and susceptibility to interference makes such sourced systems unfit for tracking multiple users in a large working volume. The largely “sourceless” nature of inertial orientation tracking makes possible a full body tracking system that avoids the problems associated with current technologies.

Inertial orientation tracking is based upon the same methods and algorithms as those used for missiles,

aircraft, and ships. Inertial angle tracking involves placing multiple Magnetic Angular Rate Gravity (MARG) sensor units on the human body. Each MARG sensor contains three orthogonal rate sensors, three orthogonal accelerometers and three orthogonal magnetometers. Integration of angular rate sensor data provides the information necessary to calculate an orientation for each human body segment. Drift and scale factor corrections to these orientations are made continuously based upon accelerometer and magnetometer inputs. Body posture is determined based entirely on limb orientation and length. Complex kinematic routines are not necessary [9].

The inherent noise, manufacturing defects, and measurement errors associated with low cost inertial sensors make it impossible to accurately determine location for more than a very short period [10]. Thus, a complete inertial body tracking system must be a hybrid. Positioning of the user's icon within the VE must be accomplished through the use of a long range positioning system to locate a single body reference point. Radio Frequency (RF) positioning systems are very fast and long range by their nature [2]. Recent advances in RF systems technology makes possible translational three degree of freedom (DOF) tracking accuracy of a few millimeters at ranges of up to 100 meters [8]. Difficulties due to intermittent reception of RF positioning information could be avoided by navigating inertially in between updates.

Human body tracking using inertial sensors requires an attitude estimation filter capable of tracking in all orientations. Singularities associated with Euler angles make them unsuitable for use in body tracking applications. Quaternions are an alternate method of orientation representation gaining popularity in the graphics community [22]. They are an extension of complex numbers and include one real and three “imaginary” parts. Quaternion rotation is more efficient than the use of transformation matrices and does not involve the use of trigonometric functions. This paper describes the design, implementation, and preliminary testing of an attitude estimation filter based upon quaternions.

A Quaternion Attitude Filter

Figure 1 is a block diagram for a complementary quaternion-based attitude estimation filter. The filter takes inputs from a nine axis MARG sensor. Its output is a unit quaternion representation of the orientation of the tracked object, \hat{q} . The inputs are from a three-axis angular rate sensor (p, q, r), a three-axis accelerometer (h_1, h_2, h_3), and a three-axis magnetometer (b_1, b_2, b_3).

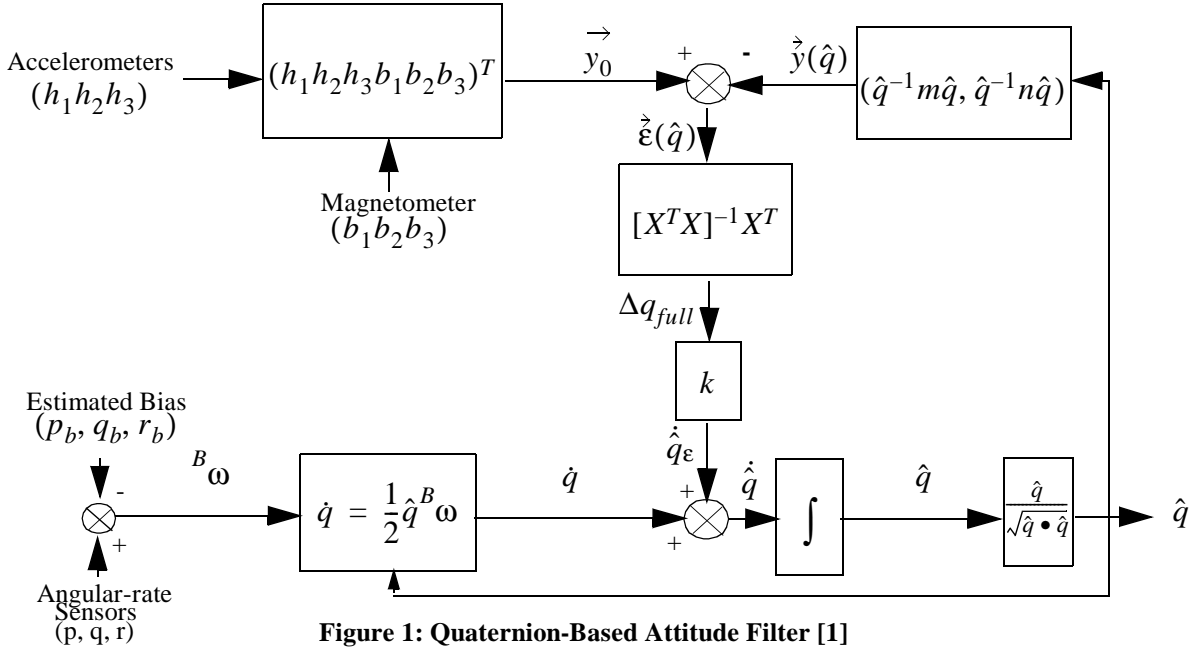

Figure 1: Quaternion-Based Attitude Filter [1]

In an error free, noiseless world, angular rate data could be processed to obtain a rate quaternion using the relationship

$$\dot{q} = q \left(0, \frac{1}{2}p, \frac{1}{2}q, \frac{1}{2}r \right) = \frac{1}{2}q^B \omega \quad (1)$$

where the indicated product is a quaternion product and the superscript B means measured in body coordinates [4]. Single integration of \dot{q} would produce a quaternion which describes orientation quaternion. However, in an environment containing noise and errors, the output of angular rate sensors tends to drift over time. Thus, rate sensor data can only be used to determine orientation for relatively short periods unless this orientation is continuously corrected using “complementary” data from additional sensors.

Accelerometers measure the combination of forced linear acceleration and the reaction force due to gravity. That is,

$$\vec{a}_{measured} = \vec{a} - \vec{g} \quad (2)$$

Since most real-life objects do not experience constant linear acceleration, when averaged over time accelerometers return a gravity vector or the local vertical. Thus, accelerometer outputs can be used to correct orientation relative to a vertical axis.

Similarly, magnetometers measure the local magnetic field in body coordinates. This information can be used to correct rate sensor drift errors in the horizontal plane.

Parameter Optimization

Combining filter inputs can be regarded as a parameter optimization problem with the goal of minimiz-

ing modeling error. The closer the estimated orientation to the actual orientation, the smaller the modeling error. Through iteration and calculations based on the magnitude and direction of modeling errors, orientation estimations become increasingly accurate. Theoretically, when the modeling error is zero, the estimated orientation is equal to the actual orientation.

The accelerometer returns the local vertical, normalized to a unit vector h . The magnetometer returns the direction of the local magnetic field, b , also normalized to a unit vector. These two vector quantities expressed in body coordinates as pure imaginary unit quaternions are

$$h = [0 \ h_1 \ h_2 \ h_3] \quad b = [0 \ b_1 \ b_2 \ b_3] \quad (3)$$

Combining the non-zero elements of Eq. (3) produces a 6 x 1 vector representing the actual measurements taken by the accelerometers and magnetometers.

$$\vec{y}_0 = [h_1 h_2 h_3 b_1 b_2 b_3]^T \quad (4)$$

Gravity in earth coordinates is always down and can be expressed as the down unit vector in quaternion form as

$$m = [0 \ 0 \ 0 \ 1] \quad (5)$$

The local magnetic field in earth coordinates, once determined and normalized, is expressed in unit quaternion form as

$$n = [0 \ n_1 \ n_2 \ n_3] \quad (6)$$

Eq. (5) and Eq. (6) are transformed from earth fixed coordinates to body coordinates through quaternion multiplication with the estimated orientation, \hat{q} by [26]

$$h = \hat{q}^{-1}m\hat{q} \quad b = \hat{q}^{-1}n\hat{q} \quad (7)$$

Combining the non-zero or imaginary part of Eq. (7) into a single 6 x 1 “computed measurement vector” produces

$$\check{y}(\hat{q}) = [\hat{h}_1\hat{h}_2\hat{h}_3\hat{b}_1\hat{b}_2\hat{b}_3]^T \quad (8)$$

Eq. (4) represents the measured gravity vector and magnetic field. Eq. (8) is the computed gravity vector and magnetic field found using Eq. (7) and is based upon the best estimate of the current orientation. The difference between the actual measurements and the computed measurement is the error vector or modeling error

$$\check{\epsilon}(\hat{q}) = \check{y}_0 - \check{y}(\hat{q}) \quad (9)$$

In viewing Eq. (9), note that if $\hat{q} = q$ in Eq. (7) and there is no measurement noise, the difference between the measured and computed values, $\epsilon(q)$, will equal the zero vector.

The square of the filter modeling error is termed the “criterion function”

$$\varphi(\hat{q}) = \check{\epsilon}^T(\hat{q})\check{\epsilon}(\hat{q}) \quad (10)$$

In the current version of the filter, $\varphi(\hat{q})$ is minimized using Gauss-Newton iteration. This method is based on linearized least squares regression analysis where \check{y}_0 is considered a vector of data points and $\check{y}(\hat{q})$ is a vector to be fitted to those points. The full correction step to the measured rate quaternion is [17]

$$\Delta q_{full} = [X^T X]^{-1} X^T \epsilon(\hat{q}) = S^{-1} X^T \epsilon(\hat{q}) \quad (11)$$

where X is defined as

$$X_{ij} = \begin{bmatrix} \frac{\partial y_i}{\partial \hat{q}_j} \end{bmatrix} \quad (12)$$

Eq. (11) treats m and n as if they are perfect measurements of forced linear acceleration and the local magnetic field. In dealing with data corrupted by noise, a scalar multiplier α is used.

$$\Delta q_{partial} = \alpha [X^T X]^{-1} X^T \epsilon(\hat{q}) \quad (13)$$

where $0 < \alpha < 1$. In the absence of noise, α would be set to

nearly one. Very noisy or inaccurate measurements would demand that the scalar multiplier α be given a value closer to zero. For a discrete approximation to a continuous time filter, referring to Figure 1

$$\alpha = k\Delta t \quad (14)$$

Thus, for discrete time step integration, the next estimate of orientation would be

$$\begin{aligned} \hat{q}_{n+1} &= \hat{q}_n + \frac{1}{2}\hat{q}_n^B \omega \Delta t + \alpha [X^T X]^{-1} X^T \epsilon(\hat{q}_n) \\ &= \hat{q}_n + k\Delta t \Delta q_{full} + \dot{q}_{measured} \Delta t \end{aligned} \quad (15)$$

In the continuous time domain, Eq. (15) becomes

$$\dot{\hat{q}} = \dot{\hat{q}}\epsilon + \dot{q}_{measured} = k\Delta q_{full} + \dot{q}_{measured} \quad (16)$$

Linearization

Figure 2 is a time domain signal flow graph (SFG)[14] of the linearized quaternion attitude estimation filter. The inputs n_1 and n_2 are maneuver induced noise and rate sensor noise respectively. The basis for linearization is the assumption that in the absence of measurement noise the computation of Δq_{full} is exact and therefore

$$\Delta q_{full} = q_{true} - \hat{q} \quad (17)$$

This assumption would be exact only if y depended linearly on q , which it does not.

Application of Mason’s formula [14] to Figure 2, produces

$$\frac{\hat{q}}{\dot{q}_{true}} = \frac{kp^{-2} + p^{-1}}{1 + kp^{-1}} = \frac{p^{-1}(1 + kp^{-1})}{1 + kp^{-1}} = p^{-1} \quad (18)$$

where p^{-1} is the time integration operator [14]. Thus, with correct initial conditions, in the absence of noise,

$$\hat{q} = p^{-1} \dot{q}_{true} = q_{true} \quad (19)$$

regardless of the value of k . This means that, under the linearization assumptions, Figure 1 is a complementary filter [3] since, for all k , if n_1 and n_2 are zero, then $\hat{q} = q_{true}$.

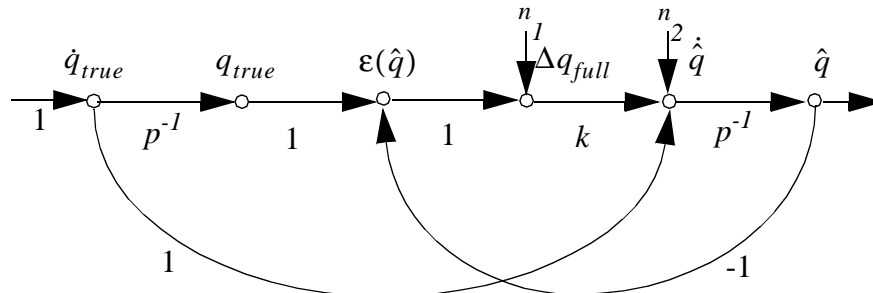

Figure 2: Signal Flow Graph for Linearized System [15]

Noise Response

Applying Mason's formula to noise disturbances n_1 and n_2 in Figure 2, produces the following low pass filter transfer functions.

$$\frac{\hat{q}}{n_1} = \frac{kp^{-1}}{1+kp^{-1}} = \frac{k}{p+k} \quad (20)$$

$$\frac{\hat{q}}{n_2} = \frac{p^{-1}}{1+kp^{-1}} = \frac{1}{p+k} \quad (21)$$

Eq. (20) and Eq. (21) can be used to find an optimal k value in Eq. (16) based upon power spectral density functions for both the noise signals and actual maneuvering behavior of the tracked object. Unfortunately, this information will rarely be available, so ad hoc "tuning" of k is more likely to succeed in practical circumstances [27].

Response to Initial Condition Errors

Eq. (19) assumes that \hat{q} has been correctly initialized. In order to understand how an erroneous \hat{q} approaches q_{true} over time consider the following static sensor scenario. Suppose the sensor is mounted in a static fixture so that all euler angles are zero and thus

$$q_{true} = (1 \ 0 \ 0 \ 0) \quad (22)$$

Assume that the unit quaternion \hat{q} is incorrect and is represented by

$$\hat{q}_0 = (1 \ \delta_x \ \delta_y \ \delta_z) \quad (23)$$

where all δ are small quantities. In the absence of motion and noise, $\dot{q}_{true} = 0$ and both n_1 and n_2 equal zero. Therefore, Figure 2 can be simplified to Figure 3 as follows:

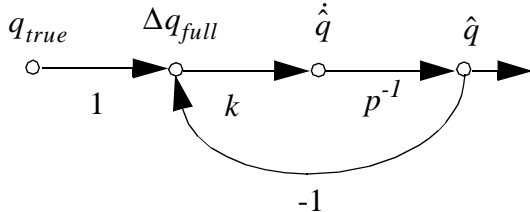

Figure 3: Simplified SFG, Static Testing, Zero Noise [16]

Based on Figure 3, the initial value for Δq_{full} is

$$\hat{q}_1 = q_{true} - \hat{q}_0 = (0 \ -\delta_x \ -\delta_y \ -\delta_z) \quad (24)$$

Since the first component of \hat{q}_1 in Eq. (24) will always be zero, it can be assumed that the first component of Eq. (22) will remain unchanged and \hat{q} will take on the form

$$\hat{q} = (1 \ \hat{x} \ \hat{y} \ \hat{z}) \quad (25)$$

Figure 4 is a Laplace transform SFG for the scalar \hat{x} . From the application of Mason's formula it follows that

$$\frac{\hat{X}(s)}{\delta_x} = \frac{s^{-1}}{1+ks^{-1}} = \frac{1}{s+k} \quad (26)$$

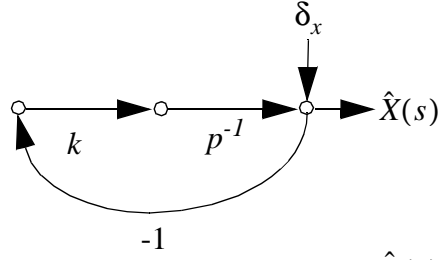

Figure 4: Transform Domain SFG, $\hat{X}(s)$ [16]

Employing the inverse Laplace transform produces the result

$$\hat{x}(t) = \delta_x e^{-kt} \quad (27)$$

Equivalent results apply for $\hat{y}(t)$ and $\hat{z}(t)$. This implies that any transient errors in \hat{q} resulting from erroneous initialization will persist for a time inversely proportional to k . Specifically

$$\tau_{\Delta q} = \frac{1}{k} \quad (28)$$

and for any disturbance δ_x , the resulting errors in the x component of \hat{q} will be

$$\varepsilon_{\hat{x}}(t) = \delta_x e^{-t/\tau_{\Delta q}} \quad (29)$$

Thus, it can be predicted that any error will be reduced to 37% of the initial value by the time $t = \tau_{\Delta q}$. Similar results apply to δ_y and δ_z .

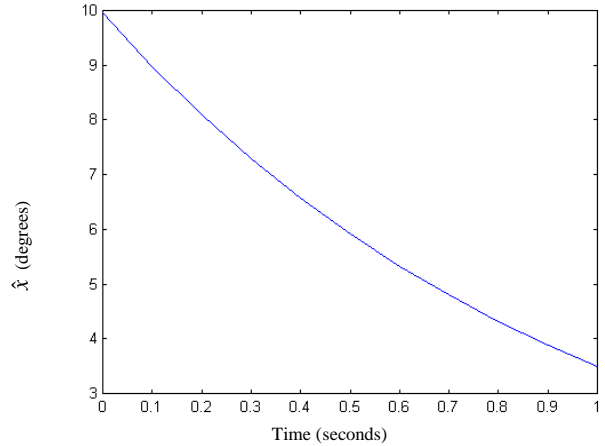

Figure 5: Simulated Nonlinear Filter Response, 10 Degree Offset, $\alpha=0.1$, $\Delta t=0.1$ [7]

Since the nonlinear simulation results, shown in Figure 5, are in close agreement with linear theory, the validity and value of linearization is established [12]. This theory provides a framework under which to choose filter gains [7]. White noise simulation shows noise reduces accuracy, but the filter still works well [7].

Bias Effects

Integration of a biased angular rate signal will cause a steady state error in a complementary filter. To reduce this effect, following the approach described in [21],

an initial estimate for bias can be calculated by averaging rate sensor output prior to maneuvering and then tracking the time-varying bias with a very long time constant, low pass filter.

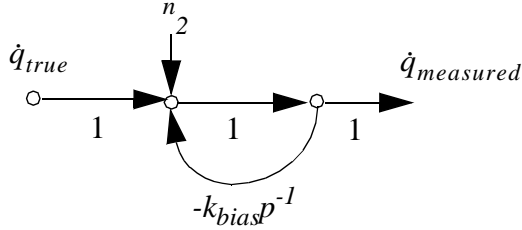

Figure 6: Bias Estimation Filter SFG [15]

From Figure 6

$$\frac{\dot{q}_{measured}}{\dot{q}_{true}} = \frac{1}{1 + k_{bias}p^{-1}} = \frac{p}{p + k_{bias}} \quad (30)$$

which is the equation for a highpass filter with a 3db cutoff at

$$\omega_c = k_{bias} \quad (31)$$

Based on the high-pass nature of Eq. (30), it can be seen that the addition of bias estimation to the quaternion filter means it will no longer be complementary [3]. This is evident since constant rotation rates will over time be eliminated from $\dot{q}_{measured}$. Thus, k must be greater than zero in Eq. (16) in order to detect these rates. In [21] it is shown that this effect can be minimized by applying the constraint

$$k \gg k_{bias} \quad (32)$$

Note, however, that if k is too large, the filter may become unstable or too much maneuver induced error will appear in \dot{q} . Thus, for a given k_{bias} , it can be expected there will be an optimal k value.

From Eq. (28), it can be seen that k should not be too small if the filter is to converge in a reasonable time period. On the other hand, $\tau_{\Delta q}$ must be larger than the maneuver time constant, $\tau_{maneuver}$, in order to adequately suppress maneuver noise. Combining this result with Eq. (32) leads to the qualitative requirement

$$\tau_{maneuver} \ll \tau_{\Delta q} \ll \tau_{bias} \quad (33)$$

or

$$1/\tau_{maneuver} \gg k \gg 1/\tau_{bias} \quad (34)$$

This result in addition to Eq. (17) provides guidelines for the selection of “reasonable” values for k and Δt . With power spectral density functions for \dot{q}_{true} , n_1 and n_2 , a Kalman filtering approach [3] could be used for this problem. In the absence of such statistical information, gain values may be selected through experimental “tweaking” of the scalar gain, k , in laboratory studies.

Sensor Design

The prototype MARG sensors used in this research were custom built. No significant attempt was made to produce a very small sensor. Ease of use and construction were the overriding factors affecting sensor

design. Each sensor was constructed using off-the-shelf, low cost components.

The primary sensing components are a micromachined 3-axis accelerometer [5], a 3-axis magnetometer [13] and three miniature angular rate sensors [25]. These sensor components are housed in a light-weight case surrounded by foam to prevent shock damage and to provide a stable temperature environment for the rate sensors (Figure 7). Each sensor package measures 10.7 x 5 x 3.7 cm, with foam coverage. The analog output of the sensor is connected to a breakout header via a ribbon cable. Output range is 0-5 vdc. The power requirement of the sensors is 12 vdc at approximately 50 milliamperes.

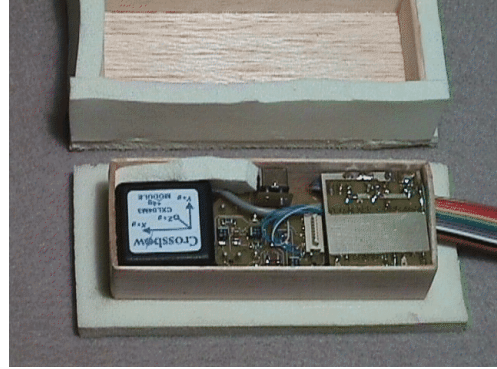

Figure 7: Prototype Nine-axis Inertial Sensor [18]

Sensor output is translated from analog to digital by a 16 bit data acquisition card [20] physically inserted into the PCI slot of a standard Pentium II PC.

System Implementation

The angle sensing system is implemented using the C++ programming language and the Visual C++ 5.0 compiler. The filter and visual simulation software run on a single standard Pentium PC under the Windows 95 operating system. Design was completed using the Unified Modeling Language (UML) [6]. The code follows object oriented paradigms and is designed to be the building block for a body suit using multiple inertial sensors. [7]

Experimental Results

Initial quantitative testing of the system was completed using a Hass rotary tilt table [11]. The table has two degrees of freedom and is capable of positioning to an accuracy of 0.001 degrees at rates ranging from 0.001 to 80 degrees/second. In order to mitigate any possible magnetic field effects generated by the servos of the tilt table, the sensor package was mounted on a non-ferrous extension above the table. The extension was approximately the length of a normal human fore-arm.

The preliminary test procedure consisted of repeatedly cycling the sensor through various angles of roll, pitch and yaw at rates ranging from 10 to 30 deg./sec. After each motion, the table was left static for approximately 15 seconds. Filter update rate was 55 Hz throughout the tests. Figure 8 is a typical result. The overall smoothness of the plot shows excellent dynamic response. Accuracy was measured to be within one degree. The small impulses which

can be observed each time motion is initiated are hypothesized to be linear acceleration effects exaggerated by the “whipping” motion of the extension on which the sensor was mounted. It is expected that calibration of the filter scale and gain values will reduce this effect and improve accuracy and dynamic response further. In qualitative tests, the quaternion filter exhibited no difficulty in tracking orientations in which pitch angles equaled or exceeded 90 degrees.

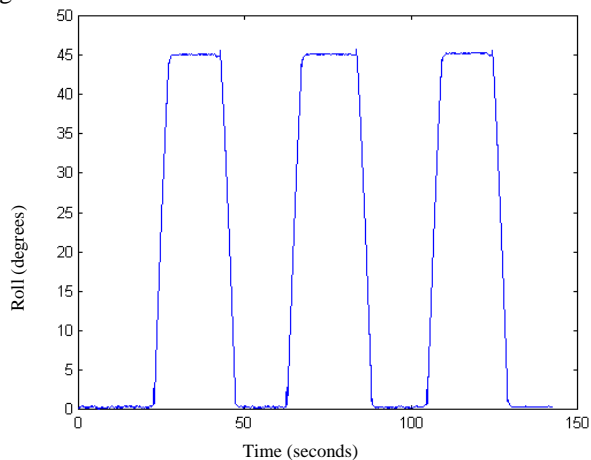

Figure 8: 45 Degree Roll Excursions at 10 deg/sec

Human Limb Segment Tracking

The primary thrust of ARO sponsored research in human modeling was to build an articulated model of a human based on quaternions. Four different methods can be used to animate the resulting model. These include key-frame animation with interpolation between key frames, procedural animation based on scripted motion, user controlled animation using a mouse and direct input of unit quaternion data from a quaternion filter object. Control types included forward kinematics with Euler angles, forward kinematics with quaternions and simple algebraic inverse kinematics. This multitude of control types allowed study and comparison of the various representations in terms of efficiency and singularities.

The central component of the model as it relates to inertial tracking is called the *localMatrix* object. The orientation of each of the 16 body segments of the human model are defined in an instance of the *localMatrix* object. In addition these instances supply conversion functions for three types of rotation methods: Euler angles, quaternions and vector-angle pair [24].

When used in conjunction with quaternion filter orientation data there is no need for inverse kinematics to apply the inputs. Instead, quaternion filter outputs are applied directly to each individual segment. This is possible because the filter supplied data is in earth fixed coordinates. Thus, each segment is orientated independently and is not affected by the transformations of those joints connected to its ends. It is only necessary to insure that the ends of adjoining segments remain connected at their shared joint. Using a simple substitution matrix, quaternions are applied directly to the graphics pipeline. The quaternion system doesn't use any trigonometric functions and requires just 16

matrix multiplications. Figure 9 shows motion tracking using inertial data processed by a quaternion attitude filter. The two MARG sensors used can be seen in each figure. One is for the upper arm, and the other for the fore arm [24].

In a large scale networked virtual environment, it is often necessary to dead reckon entities between updates. To this end, algorithms for the interpolation of quaternions are also included in the model. These algorithms allow for the dead reckoning of human limb segments [24].

Future Work

The primary goal of this research is to produce a full body motion tracking system and to integrate this system into a networked virtual environment. The inertial angle tracking software and prototype sensors described in this paper are the first step. Included in the areas of future work are sensor size reduction, application of optimal filter theory to the filter software, body suit design and development, RF positioning system development, and large scale network integration.

The primary concerns in the design of the current prototype sensor were ease of use and construction. Extensive effort was not devoted to size reduction. Future sensors must be much smaller to be of practical use. Current plans call for integrating the Analog Devices Accelerometers with the rate sensors and magnetometers on a surface mount printed circuit board. Micromachined replacements for the angular rate sensors are also being investigated. Possible candidates include those developed by Bosch GmbH for skid control in Damiler-Benz automobiles [23].

The current filter design is not optimal. Lack of statistical data in the form of power spectral density functions for both maneuver and measurement noise currently prevents the use of optimal filtering techniques in this application. Future versions of the filter may also employ rigid body dynamics as a “process model” to further smooth orientation estimates [3].

In order to track humans in a VE, it will be necessary to outfit them with body suits. Each suit must incorporate multiple inertial trackers, at least one position tracker, and an electronics unit capable of processing sensor data. This sensor data would be packaged into a serial bit-stream for wireless transmission to a base unit. Calibration, avoidance of user encumbrance, and sensor attachment will be primary concerns.

Inertial information from small, low-cost sensors can only be used to reliably estimate orientation. To complete the full body tracking system, positioning system information for location of a single reference point on the body must be integrated with the angle information provided by the inertial sensors. The excellent ranging capabilities, resistance to interference, and code division multiplexing characteristics of spread-spectrum RF make it a promising choice for this application [2].

Networked virtual environments suffer from the limitations of both bandwidth and processing power. Current simulation protocols do not well support articulated humans as entities. Work needs to be completed to facilitate insertion of high-resolution humans. This goal requires that a better understanding of encapsulation of gesture data be developed. Efficient transmission methods must also be devised.



(a) Initial Position



(b) Fore Arm Motion



(c) Forearm and Upper Arm Motion



(d) 90 Degrees of Elevation at the shoulder

Figure 9: Motion Tracking of the Right Fore and Upper Arm with Two Inertial Sensors [24]

Conclusions

Due to its lack of continuous dependence on an external source, hybrid inertial body tracking has the potential of avoiding the shortcomings associated with current technologies. This paper describes a quaternion attitude filter designed for inertial tracking of human limb segment orientation. Inertial tracking also offers a method of accurately determining robot arm end effector position and orientation when individual links flex or bend. Filter error correction is done by Gauss-Newton iteration based on linearized least squares regression analysis. The filter is complementary if bias compensation effects are not considered. Brief descriptions of a prototype inertial sensor and system software implementation are presented. Preliminary dynamic test results of the inertial tracking system are also described. The final portion of the paper outlines the work which will be required to produce a full body motion tracking system and integrate this system into a networked virtual environment.

Acknowledgments

This research was primarily supported by the Army Research Office (ARO) under Proposal No. 37660-MA. Additional sponsors include the National Science Foundation (NSF), the Institute for Joint Warfare Analysis (IJWA), Advanced Network and Services Inc., and direct funding from the Naval Postgraduate School (NPS).

References

- [1] Bachmann, E., *Research Notes: Quaternion Attitude Filter*, Computer Science Department, Naval Postgraduate School, Monterey, California, 1996
- [2] Bible, S. R., Zyda, M. J., and Brutzman, D. P., "Using Spread-Spectrum Ranging Techniques for Position Tracking in a Virtual Environment" in the *Proceedings of the 1995 Workshop on Networked Realities*, Boston,

Massachusetts, October 26-28, 1995.

- [3] Brown, R., Hwang, P., *Introduction to Random Signals and Applied Kalman Filtering, Second Edition*, John Wiley and Sons, Inc., New York, New York, 1992.
- [4] Cooke, J. M., et. al., "NPSNET: Flight Simulation Modeling Using Quaternions", *Presence*, Vol. 1, No. 4, Fall, 1992, pp. 404-420.
- [5] *Crossbow CXL04M3 Data Sheet*, Crossbow Inc. 1998.
- [6] Douglass, B., *Real-Time UML Developing Efficient Objects for Embedded Systems*, Addison Wesley, Massachusetts, May 1998.
- [7] Duman, I., *Design, Implementation and Testing of a Real-Time Software System for a Quaternion-Based Attitude Estimation Filter*, Master's Thesis, Naval Postgraduate School, Monterey, California, March, 1999.
- [8] Feng, J., *An RF Head-Tracker, Phase I Final Report*, NAVAIR SBIR Topic No. N95-144, 19 October 1996.
- [9] Frey, W., *Application of Inertial Sensors and Flux-Gate Magnetometers to Real-Time Human Body Motion Capture*, Master's Thesis, Naval Postgraduate School, Monterey, California, September 1996.
- [10] Foxlin, E., "Constellation: A Wide-Range Wireless Motion-Tracking System for Augmented Reality and Virtual Set Applications", *Proceedings of SIGGRAPH '98*, ACM, 1998, pp. 371-378
- [11] *Haas Model: TRT-7 Tilting Rotary Table*, Haas Automation, Inc., Chatsworth, CA, July 1992.
- [12] Henault, German A., *A Computer Simulation Study and Component Evaluation for a Quaternion Filter for Sourceless Tracking of Human Limb Segment Motion*, Master's Thesis, Naval Postgraduate School, Monterey, California, March 1997
- [13] *Honeywell Three-Axis Magnetic Sensor Hybrid, HMC2003*, Honeywell Inc. 1998
- [14] Kuo, E., *Automatic Control Systems, Seventh Edition*, Prentice Hall, Inc., Englewood Cliffs, New Jersey, 1995.
- [15] McGhee, R., *Research Notes: Linearization of a Quaternion Attitude Filter*, Computer Science Department, Naval Postgraduate School, Monterey, California, 1998.
- [16] McGhee, R., *Research Notes: Response of Quaternion Filter to Initial Condition Errors*, Computer Science Department, Naval Postgraduate School, Monterey, California, 1998
- [17] McGhee, R., "Some Parameter-Optimization Techniques", *Digital Computer User's Handbook*, McGraw-Hill, 1967, pp. 234-253.
- [18] McKinney Technology, Doug McKinney, 9 Glen Avenue, Prunedale, CA, 93907.
- [19] Meyer, K., Applewhite, H. L. and Biocca, F. A., "A Survey of Position Trackers", *Presence: Teleoperators and Virtual Environments*, Spring, 1992, Vol. 1, No. 2, pp. 173-200.
- [20] *PCI-MIO-16XE-50 Data Acquisition (DAQ) Card*, National Instruments Corporation, 1998.
- [21] Roberts, R., *Analysis, Experimental Evaluation, and Software upgrade for Attitude Estimation by the Shallow-water AUV Navigation System (SANS)*, Master's Thesis, Naval Postgraduate School, Monterey, California, March 1997.
- [22] Shoemake, K., "Animating Rotation with Quaternion Curves", *Proceedings of SIGGRAPH '85*, ACM, 1985, pp. 245-254.
- [23] Teegarden, D., et. al., "How to Model and Simulate Microgyroscope Systems", *IEEE Spectrum*, July 1998, pp. 66-75.
- [24] Usta, U. Y., *Comparison of Quaternion and Euler Angle Methods for Joint Angle Animation of Human Figure Models*, Master's Thesis, Naval Postgraduate School, Monterey, California, March, 1999.
- [25] *Token CG16D Solid State Rate Sensor Data Sheet*, Token American Inc., 1998.
- [26] Watt, A., and Watt, M., *Advanced Animation and Rendering Techniques, Theory and Practice*, ACM Press, New York, New York, 1992.
- [27] Yun, X., et. al., "Testing and Evaluation of an Integrated GPS/INS System for Small AUV Navigation", accepted for publication in *IEEE Journal of Ocean Engineering*, 1999.