



Procedure for statistical analysis of single scan modulation transfer functions for optical transmission in the marine boundary atmosphere.

Title	Procedure for statistical analysis of single scan modulation transfer functions for optical transmission in the marine boundary atmosphere.
Item Type	Thesis
Authors	Molland, Rolf A.
URI	https://hdl.handle.net/10945/18526
Publisher	Monterey, California. Naval Postgraduate School
Date Issued	1978
Download date	2026-04-15 00:55:25
Link to Item	https://hdl.handle.net/10945/18526

Downloaded from NPS Archive: Calhoun



DUDLEY KNOX LIBRARY
NAVAL POSTGRADUATE SCHOOL
MONTEREY, CA 93940

NAVAL POSTGRADUATE SCHOOL

Monterey, California



THESIS

PROCEDURE FOR STATISTICAL ANALYSIS OF SINGLE
SCAN MODULATION TRANSFER FUNCTIONS FOR OPTICAL
TRANSMISSION IN THE MARINE BOUNDARY ATMOSPHERE

by

Rolf A. Molland

December 1978

Thesis Advisor:

Edmund A. Milne

Approved for public release; distribution unlimited.

T187392

REPORT DOCUMENTATION PAGE		READ INSTRUCTIONS BEFORE COMPLETING FORM
1. REPORT NUMBER	2. GOVT ACCESSION NO.	3. RECIPIENT'S CATALOG NUMBER
4. TITLE (and Subtitle) PROCEDURE FOR STATISTICAL ANALYSIS OF SINGLE SCAN MODULATION TRANSFER FUNCTIONS FOR OPTICAL TRANSMISSION IN THE MARINE BOUNDARY ATMOSPHERE.		5. TYPE OF REPORT & PERIOD COVERED Master's Thesis; December, 1978
7. AUTHOR(s) Rolf A. Molland		6. PERFORMING ORG. REPORT NUMBER
9. PERFORMING ORGANIZATION NAME AND ADDRESS Naval Postgraduate School Monterey, California 93940		8. CONTRACT OR GRANT NUMBER(s)
11. CONTROLLING OFFICE NAME AND ADDRESS Naval Postgraduate School Monterey, California 93940		10. PROGRAM ELEMENT, PROJECT, TASK AREA & WORK UNIT NUMBERS
14. MONITORING AGENCY NAME & ADDRESS (if different from Controlling Office) Naval Postgraduate School Monterey, California 93940		12. REPORT DATE December, 1978
		13. NUMBER OF PAGES 126
		15. SECURITY CLASS. (of this report) Unclassified
16. DISTRIBUTION STATEMENT (of this Report) Approved for public release; distribution unlimited.		15a. DECLASSIFICATION/DOWNGRADING SCHEDULE
17. DISTRIBUTION STATEMENT (of the abstract entered in Block 20, if different from Report)		
18. SUPPLEMENTARY NOTES		
19. KEY WORDS (Continue on reverse side if necessary and identify by block number) Modulation Transfer Function (MTF) Atmospheric MTF Marine Boundary Layer Atmospheric MTF		
20. ABSTRACT (Continue on reverse side if necessary and identify by block number) A computer data reduction system has been reprogrammed to sample individual scan recordings of the line-spread function of laser light propagating through the turbulent marine boundary layer. The distribution of spatial frequencies of the Modulation Transfer Functions from random single scan samples from experimental data sets has been investigated. A preliminary analysis		

indicates that the zero spatial frequency component of the MTF is log-normal distributed.

Approved for public release; distribution unlimited.

PROCEDURE FOR STATISTICAL ANALYSIS OF SINGLE
SCAN MODULATION TRANSFER FUNCTIONS FOR OPTICAL
TRANSMISSION IN THE MARINE BOUNDARY ATMOSPHERE

by

Rolf A. Molland
Lieutenant Commander, Royal Norwegian Navy
B.S., Norwegian Naval Academy, 1966

Submitted in partial fulfillment of the
requirements for the degree of

MASTER OF SCIENCE IN PHYSICS

from the

NAVAL POSTGRADUATE SCHOOL
December 1978

ABSTRACT

A computer data reduction system has been reprogrammed to sample individual scan recordings of the line-spread function of laser light propagating through the turbulent marine boundary layer.

The distribution of spatial frequencies of the Modulation Transfer Functions from random single scan samples from experimental data sets has been investigated. A preliminary analysis indicates that the zero spatial frequency component of the MTF is log-normal distributed.

TABLE OF CONTENTS

I.	INTRODUCTION	9
II.	ANALYSIS OF DATA	11
A.	FUNCTIONAL DESCRIPTION	11
1.	Data	11
2.	Data Reduction	11
3.	Statistical Analysis	12
B.	PROGRAM THEORETICAL CONSIDERATIONS	18
1.	Normal Curve	18
2.	Goodness of Fit	19
C.	COMPUTER PROGRAMS	20
1.	Nic 80 Data Reduction Program	20
2.	Data Analysis Programs	20
3.	Program Flowcharts	22
III.	RESULTS	30
A.	CONSISTENCY OF DISTRIBUTION	30
B.	FACTORS AFFECTING DISTRIBUTIONS	35
1.	Scintillation	35
2.	Signal to Noise Ratio	35
C.	RESULTS AND DISCUSSION	35
1.	Log Normal Distribution of 0 Spatial Frequency	35
2.	Normal Distribution of Higher Frequencies	36
3.	Distribution versus Cn Value	36
D.	RECOMMENDATIONS FOR FURTHER WORK	37

APPENDIX A: Operating Instructions for Data Analysis ...113

COMPUTER PROGRAMS LISTINGS

- 1. Data Analysis Program Listing117
- 2. Data Summary Program Listing120
- 3. Nic 80 Program Listing121

LIST OF REFERENCES125

INITIAL DISTRIBUTION LIST126

LIST OF DRAWINGS

1.	Sample Data Summary	14
2.	Sample MTF \pm 1 Standard Deviation Plot	15
3.	Sample Relative Distribution of MTF	16
4.	Typical Line Spread Function	17
5.	A - B Program Organization	22
6.	A - D Data Analysis Program	24
7.	A - B Data Summary Program	28
8.	A - C Data Analysis Program Listing	117
9.	Data Summary Program Listing	120
10.	A - D Nic 80 Program Listing	121

LIST OF TABLES

I.	Data Analysis Summary	31
II.	Grading Consistency of Data from Same Data Set	34
III.	Consistency of Individual Frequency Components from Samples of Same Data Set	34
IV.	Ratio of Distribution Graded 1 for Different Cn Ranges	37

I. INTRODUCTION

Atmospheric turbulence adversely affects the propagation of a laser beam or the performance of an imaging system. The Modulation Transfer Function (MTF) is a measure of the degradation of resolution and thus the relative ability of the atmosphere to transmit spatial frequency information. Knowledge of the MTF of the atmosphere is necessary for prediction of the beam cross-sectional profile on target and spot wander for a high energy laser and its beam projection system.

Members of the faculty of the Naval Postgraduate School (NPS), Department of Physics and Chemistry, have investigated the effects of atmospheric turbulence on the propagation of optical radiation in the marine boundary layer.

The work started in 1973 and has continued through 1978. The research has been concentrated on developing a model for the MTF depending on wavelength, range and a properly path-position weighted value of the turbulence structure constant for optical index C_n . The work for the period 1 July 1974 - 30 September 1977 is described in Ref. 1. Field experiments were performed by transmitting laser light of different wavelengths along various seapaths. The received intensity was detected by a slit-scanning telescope system and recorded on tape. The C_n value was determined by computer calculations.

The objective of this report is to describe the development of a computer program which samples individual scan

recordings of the line-spread function and determines a preliminary statistical distribution of the spatial frequency content of the Modulation Transfer Function.

II. ANALYSIS OF DATA

A. FUNCTIONAL DESCRIPTION

1. Data

Experimental data are the intensities of the line-spread functions as recorded on a 4-channel magnetic tape. One track is used for verbal identification of date, time and pertinent experimental information. Two tracks are used for recording scans and the last track is used for recording the trigger signal.

Verbal information has been cross-checked against experiment log book and MTF data output. Data have been recorded for one and two wavelengths simultaneously. Only data for .6328 microns have been analyzed in this report. The line-spread function was sampled by the scanning detector at a rate of 50Hz and recorded at a tape speed of 37.5 inches per second.

2. Data Reduction

The data reduction is done on a Nicolet Instrument Company, NIC-80 data processor. This is a data digitizer followed by a 12K 20-bit digital computer and a Tektronix CRT display unit. The NIC-80 computer is controlled by a Hewlett-Packard HP-9825 desk top type programmable calculator.

The NIC-80 computer reads the line-spread function for one scan, performs a Fourier Transform (FT) analysis of the signal and transfers the FT spatial frequency components 0 - 19 to the HP-9825. The MTF of the atmosphere is calculated

by dividing the FT of the line-spread function by the FT of the optics. The FT of the optics is stored by the NIC-80 and transferred to HP-9825. The experimental analog signal is digitized at 1024 points. The DC component is removed by manual setting of signal bias based upon observation of scan on CRT display. Any remaining DC component is compensated by subtracting the average intensity value of 32 points at each end of the digitized signal.

When not performing FT and transfer operations, the NIC-80 remains in signal display mode with successive scans being displayed on CRT.

The computation and transfer time for one scan has been observed to be 5 seconds, and will be the time between sampling of scans. During data reduction, the tape recorder was operated at 3.75 IPS, corresponding to 5 scans per second. This implies that about every 25th scan of the recorded data was sampled for analysis. The number of scans sampled was limited by the length of experimental data recorded, normally in the order of one minute, or 3000 scans. This allowed a sample size of 100 - 125 for data analysis. An attempt to run the recorder at .375 IPS speed was not successful due to problems with the trigger signal.

3. Statistical Analysis

The HP-9825 calculates the MTF at 20 different spatial frequencies from 0 to 38000 per radian in steps of 2000 per radian. These spatial frequency points are labeled 0 to 19 and are tested for normal and log-normal distribution. Goodness

of fit is determined by the Chi Square test. A data summary containing mean, standard deviation and Chi Square values for normal and log-normal tests is outputted on the printer. Mean and ± 1 standard deviation for frequency points 0 - 19 is plotted, with the zero spatial frequency normalized to a value of unity and all other data adjusted correspondingly. A histogram showing relative distribution of MTF values for one specific spatial frequency is plotted as requested in program input.

Examples of the above are given in Figures 1, 2 and 3 respectively. The relationship of the MTF distribution to the Cn value has been investigated. The Cn values ranged in the order of 8×10^{-8} to 1×10^{-7} . Typical line-spread functions for two different Cn values are shown in Figure 4. Note that Cn squared values are given.

The value of Cn used has been taken from existing MTF data outputs. If no output was available, an MTF analysis was performed. A detailed discussion of MTF and Cn is given in Ref. 1. The scan presentation is a function of time and detector position. The dwell time setting was obtained by analyzing calibration data recorded on tape. Dwell time is the sampling time per data point. Data have been obtained by recording the detector output with a diffraction grating of known dimensions placed in front of the telescope. This provides a known reference of angular spread. The dwell time is adjusted so that the angular spread of the first order diffraction as observed on the display is equal to the reference value.

DATA SUMMARY

DATE 92177 TIME 1555

Cn 2.790 E-8 OPTICS 0.4572

TEST DIST. NORMAL			TEST DIST LN NORMAL		
SPAT FR	MEAN	ST. DEV	CHI SQ	CHI SQ	
0	5.96432E-02	2.13149E-02	2.50799E 01	2.08758E 01	
1	5.85453E-02	1.92726E-02	2.76983E 01	2.65750E 01	
2	5.71572E-02	1.88250E-02	2.50227E 01	3.13476E 01	
3	5.65614E-02	1.86214E-02	3.08980E 01	3.84055E 01	
4	5.45106E-02	1.81653E-02	2.88112E 01	2.24956E 01	
5	5.34043E-02	1.77426E-02	2.86308E 01	2.70611E 01	
6	5.10345E-02	1.72959E-02	2.19280E 01	3.49670E 01	
7	4.92243E-02	1.67257E-02	3.22522E 01	2.40727E 01	
8	4.68538E-02	1.61444E-02	1.98058E 01	2.01919E 01	
9	4.52888E-02	1.55913E-02	2.46786E 01	2.33667E 01	
10	4.28157E-02	1.50546E-02	2.48792E 01	1.95661E 01	
11	4.09839E-02	1.49076E-02	2.41547E 01	1.82347E 01	
12	3.88307E-02	1.44746E-02	2.73854E 01	1.69891E 01	
13	3.70327E-02	1.41457E-02	2.93271E 01	1.76772E 01	
14	3.45129E-02	1.38069E-02	1.73061E 01	1.77865E 01	
15	3.25474E-02	1.38318E-02	2.05478E 01	1.22115E 01	
16	3.11232E-02	1.35534E-02	2.21258E 01	1.71241E 01	
17	2.91681E-02	1.30149E-02	2.54938E 01	1.53325E 01	
18	2.80778E-02	1.30759E-02	3.67952E 01	1.37615E 01	
19	2.62632E-02	1.29964E-02	4.01706E 01	2.06506E 01	

Figure 1

MTF MEAN AND \pm 1 STANDARD DEVIATION
 DATE 92277 TIME 1616 NO OF SCANS 100
 WAVELENGTH 0.6328 OPTICS 0.4572
 CN 5.940E-8

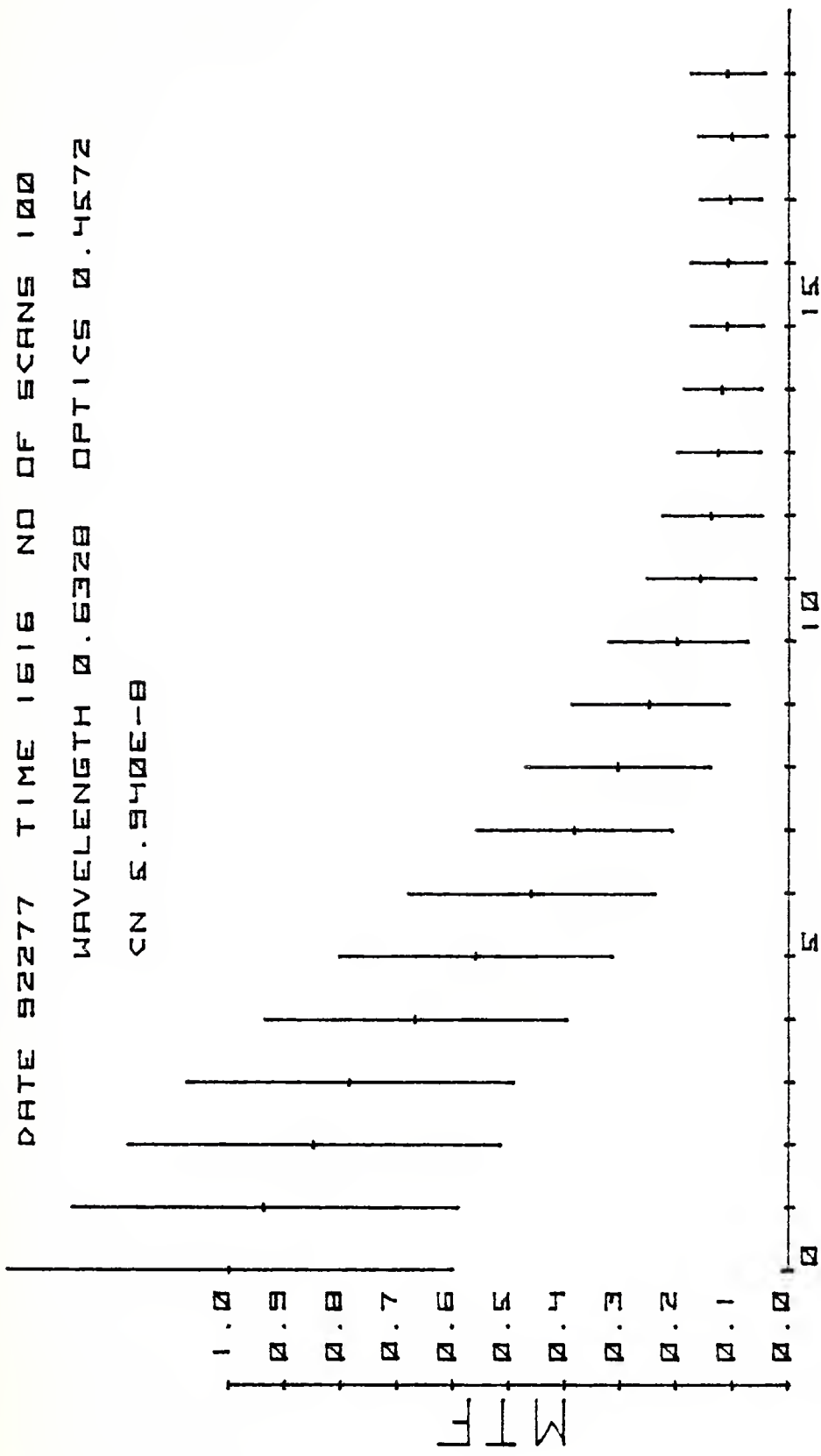

SPATIAL FREQUENCY IN 1 / MILLIRADIANS
 Figure 2

RELATIVE DISTRIBUTION OF MTF

SPATIAL FREQUENCY 2 MEAN 0.65733E-02
 NO OF SCANS 100 ST. DEV 3.39560E-02
 TEST DIST NORMAL CHI SQ 2.68801E 01
 WAVELENGTH 0.6328 CN 5.940E-8
 OPTICS 0.4572

DATE 92277 TIME 1616

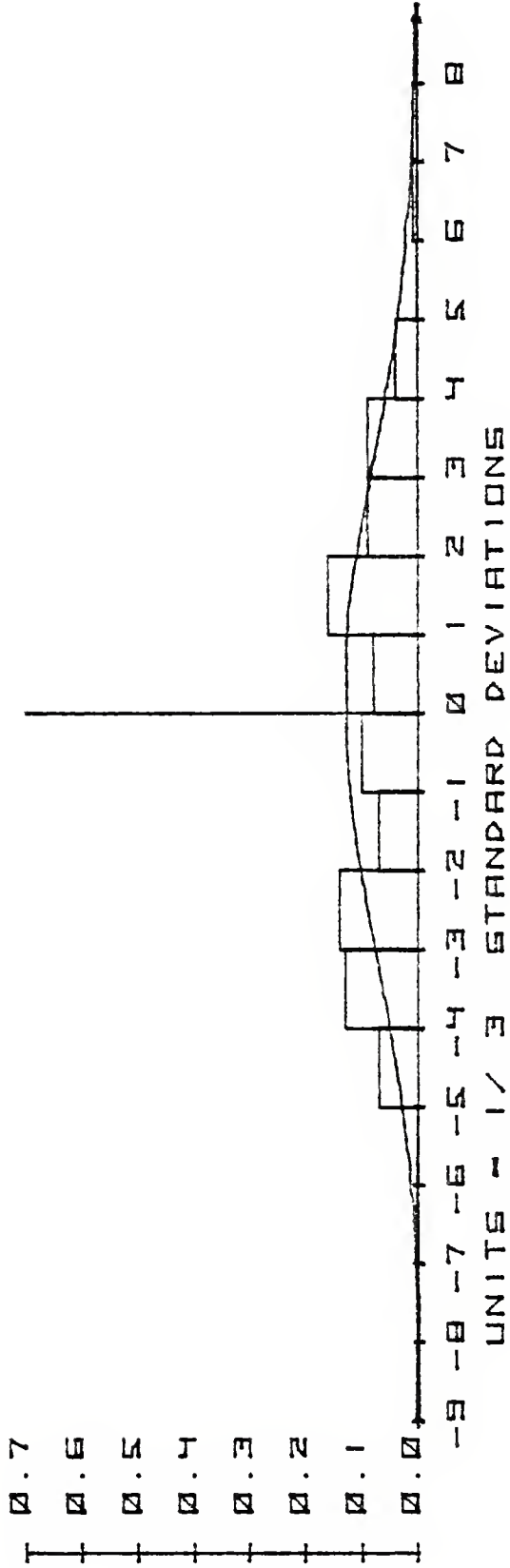
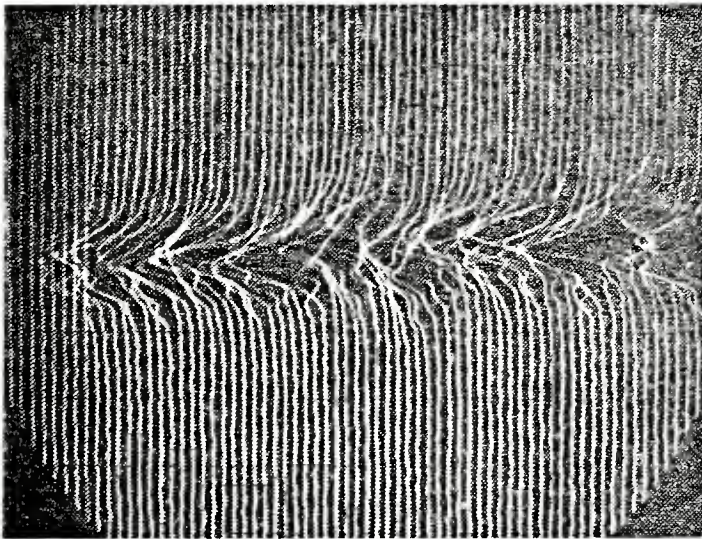
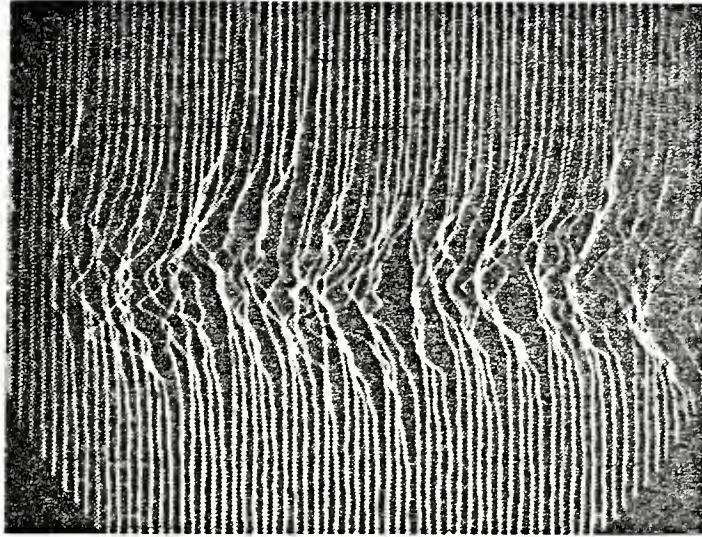

Figure 3



$$C_n^2 = 9.6 \times 10^{-16} \text{ m}^{-2/3}$$



$$C_n^2 = 30 \times 10^{-16} \text{ m}^{-2/3}$$

Figure 4. Typical Line-Spread Functions

B. PROGRAM THEORETICAL CONSIDERATIONS

The data were tested for normal and ln normal distribution.

1. Normal Curve

The normal or Gaussian curve is expressed as

$$Y = \text{constant} \exp \left(-\frac{1}{2} \left(\frac{x - \bar{x}}{s} \right)^2 \right)$$

where

x is the value of MTF for normal test distribution or value of ln MTF for log-normal distribution.

\bar{x} is the unbiased estimate of the Mean of the MTF values or Mean of ln MTF values.

s is the unbiased estimate of the standard deviation of the distribution.

Y is the probability density of the distribution.

Constant = $i/s\sqrt{2\pi}$, where i is the width of a histogram bin to make area under curve equal to 1.

The Mean \bar{x} is the arithmetic Mean given by:

$$\bar{x} = \frac{\sum_{i=1}^N x_i}{N}$$

where N is the number of observations (samples).

The standard deviation s is the positive root of the Variance s squared given by

$$s^2 = \frac{\sum_{i=1}^N (x_i - \bar{x})^2}{(N-1)}$$

For computational purposes the following algebraically equivalent formula has been used:

$$s^2 = \left(\frac{\sum_{i=1}^N (x_i)^2}{N} - \left(\frac{\sum_{i=1}^N x_i}{N} \right)^2 \right) / (N-1)$$

The probability density curve has been computed and plotted over a range of Mean \pm 3 standard deviations.

2. Goodness of Fit

Test of goodness of fit to tested distribution has been done by histogram and Chi Square calculation.

The width of the histogram bins is a program variable expressed as a ratio of the standard deviation. 1/3 has been used corresponding to a total of 18 bins. The number of samples with values within a bin is expressed as a fraction of 1, so that the area of the histogram is equal to the width of the bin interval.

The Chi Square goodness of fit value has been calculated from

$$\chi^2 = \sum_{i=1}^n \frac{[Nf(n) - F(n)]^2}{Nf(n)}$$

where

N = number of observations

n = number of histogram bins

F(n) = number of observations within a bin

The term Nf(n) is the theoretical number of observations which should fall within a bin. The probability area has been calculated as the sum of a rectangle and a triangle approximating the area under the normal curve. The sampling distribution of the Chi Square statistics is tabulated as a function of degrees of freedom and percentile. The number of degrees of freedom is calculated from

$$df = k - n - 1$$

where

k = number of bins in histogram

n = number of parameters estimated

For a 18 bin histogram with mean and standard deviation estimated, the degrees of freedom is 15, with a 95 percentile value tabulated as 25. A calculated Chi Square value less than 25 will, at the 5% significance level, imply that the data fits the given distribution.

C. COMPUTER PROGRAMS

1. NIC-80 Data Reduction Program

This program has been developed utilizing subroutines from the existing MTF analysis program. Pages 3 and 4 of the MTF program have not been changed. Main program is on page 1 and a data transfer subroutine has been inserted on page 2. Program flowchart is given in Figure 5A. Program listing is on page 122.

2. Data Analysis Program

Due to limited HP-9825 memory capacity, this program has been split into two parts stored on separate program files. During operation, programs are loaded and executed under program control. Program "A" is on file 8 and contains NIC-80 control and all analysis functions except data summary, which is on program "B" located on file 9. Programs are documented on flowcharts (Figures 6 and 7). Program listings are on pages 117-121. Execution of analysis program requires HP tape inserted with track 1 available for data storage.

Each data file must be minimum 160 bytes long and the number of files must be equal to or larger than the number of scans sampled.

Execution time for a 100 scan analysis run is of the order of 90 minutes. Most of this time is required for tape movements and operations.

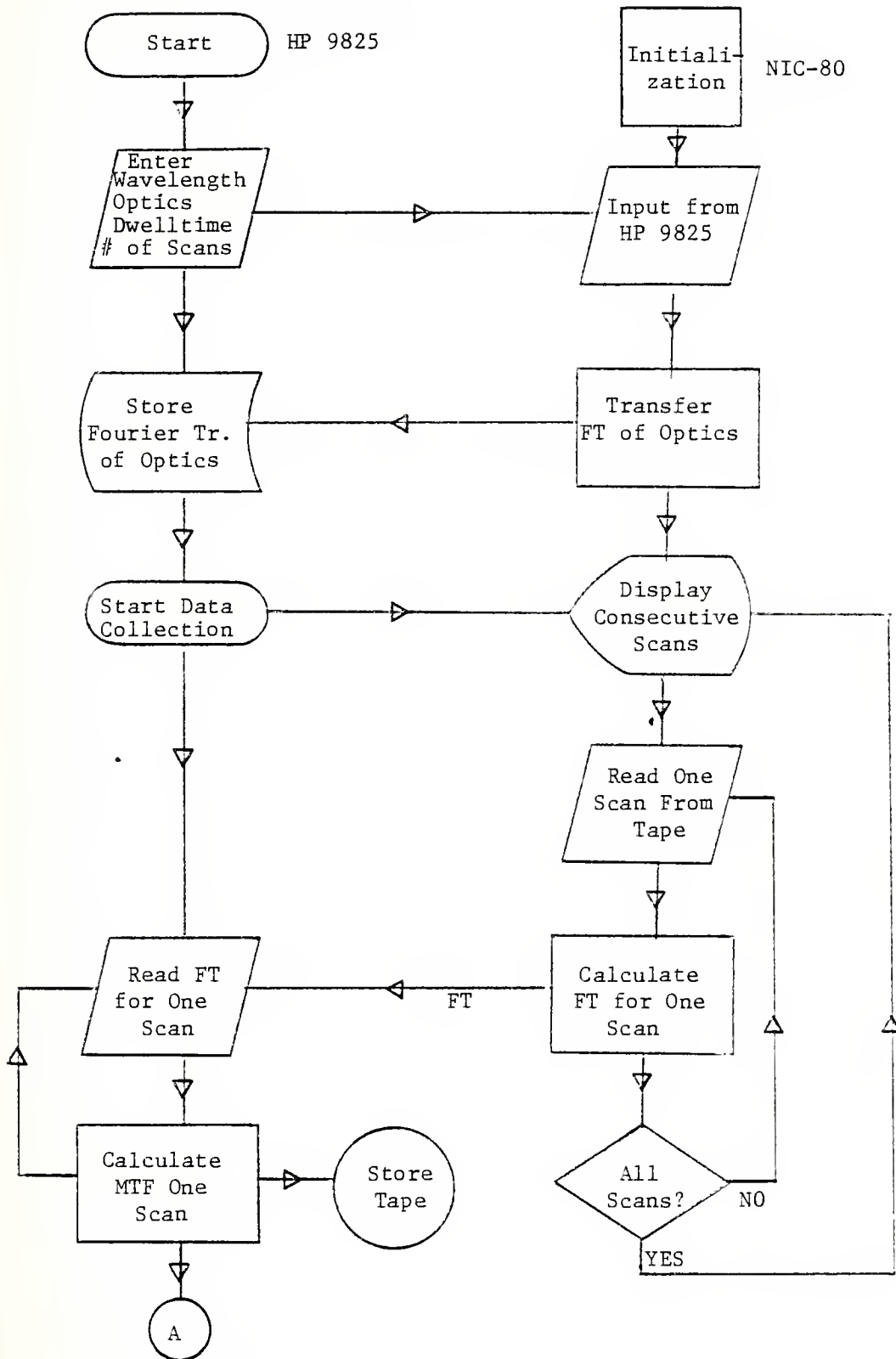

Figure 5A. Program Organization

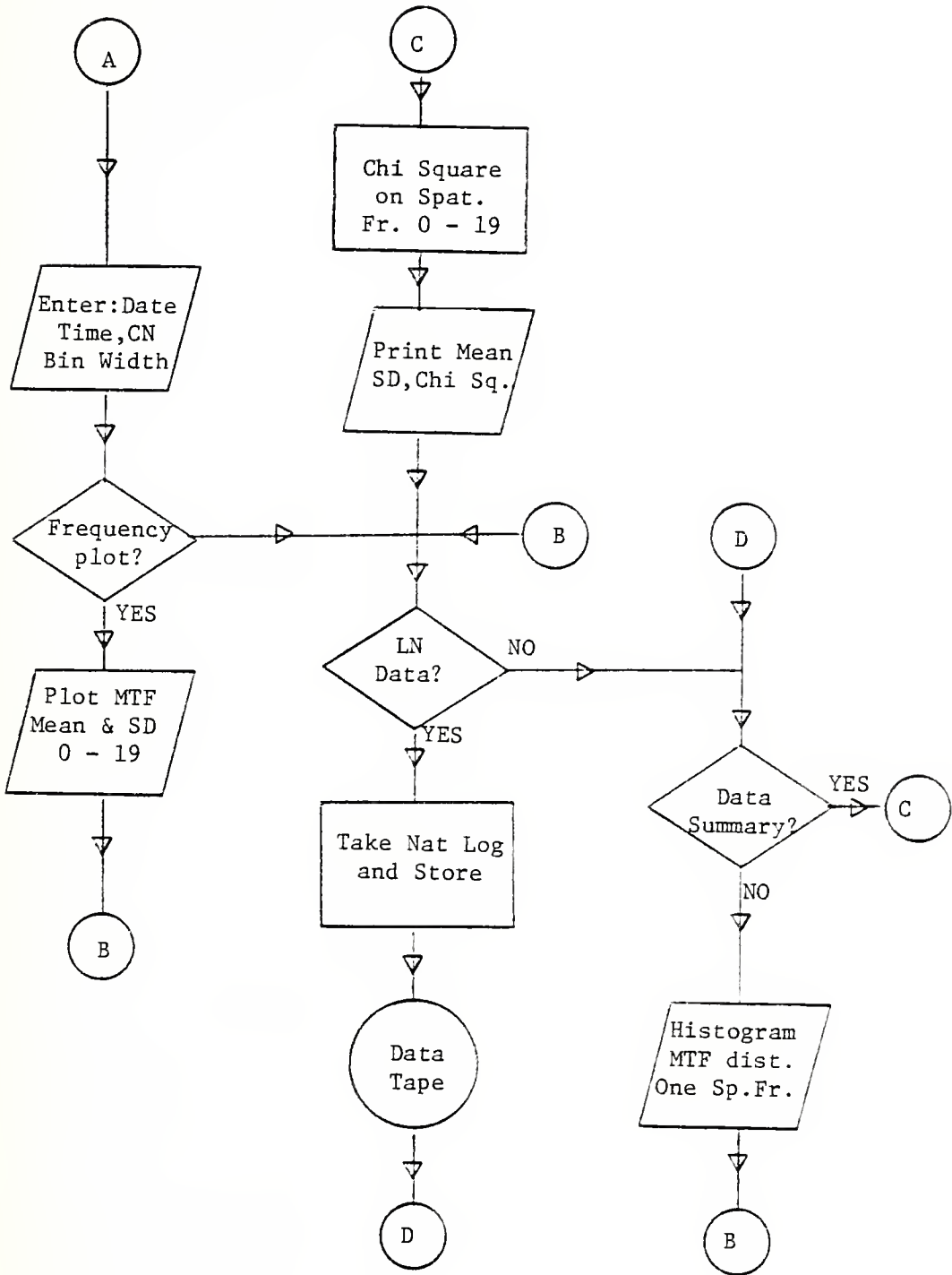

Figure 5B. Program Organization

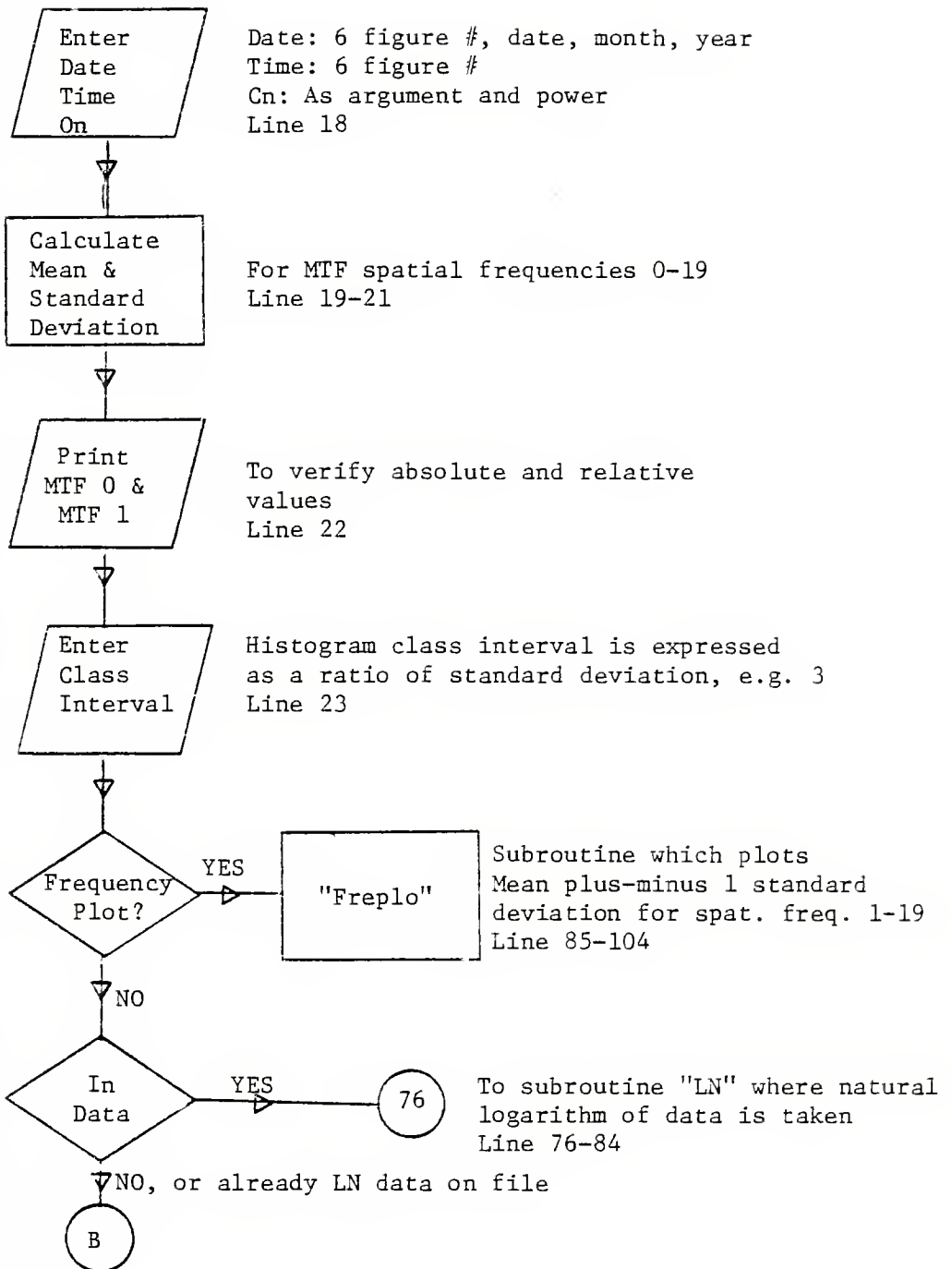

Figure 6A. Data Analysis Program

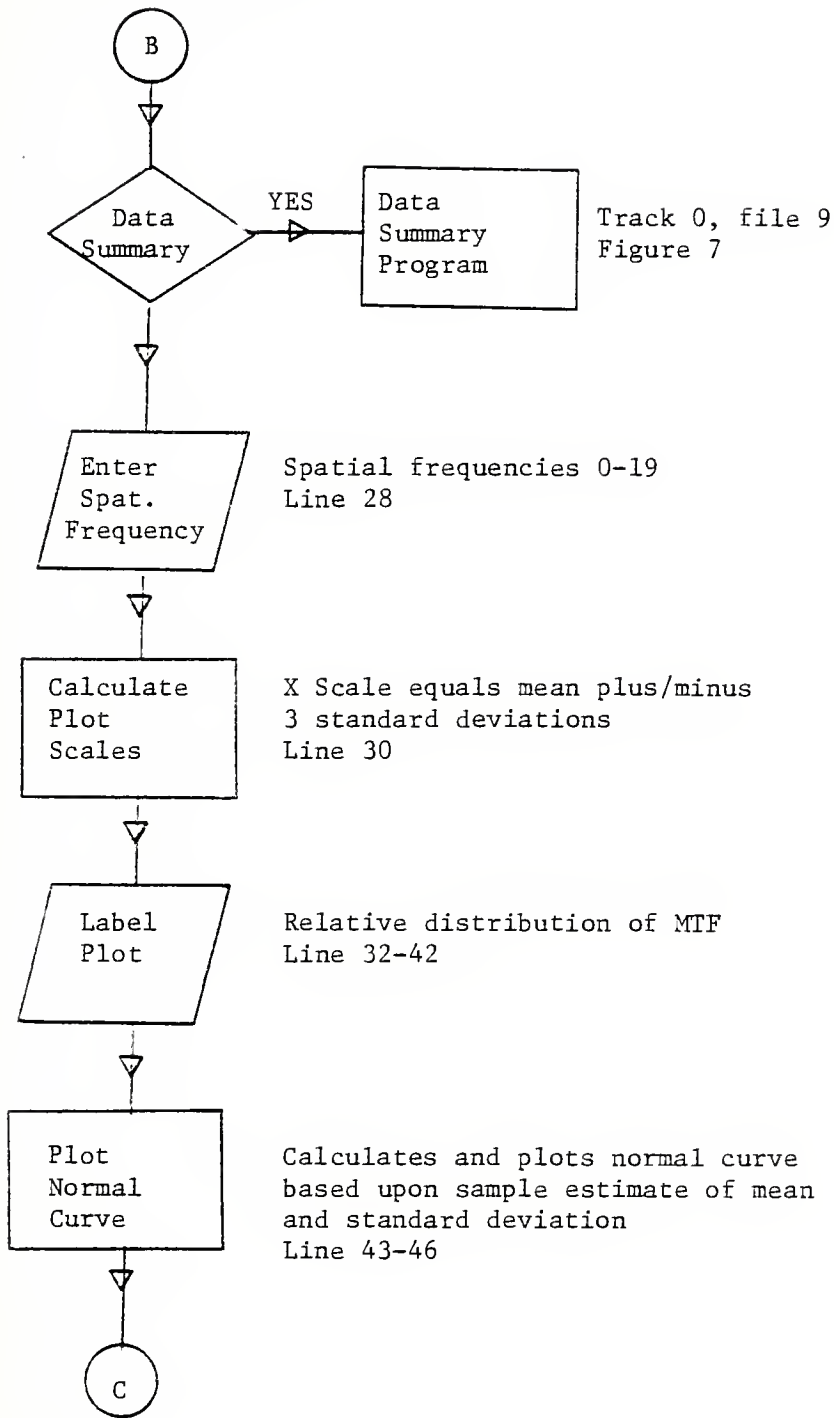

Figure 6B. Data Analysis Program

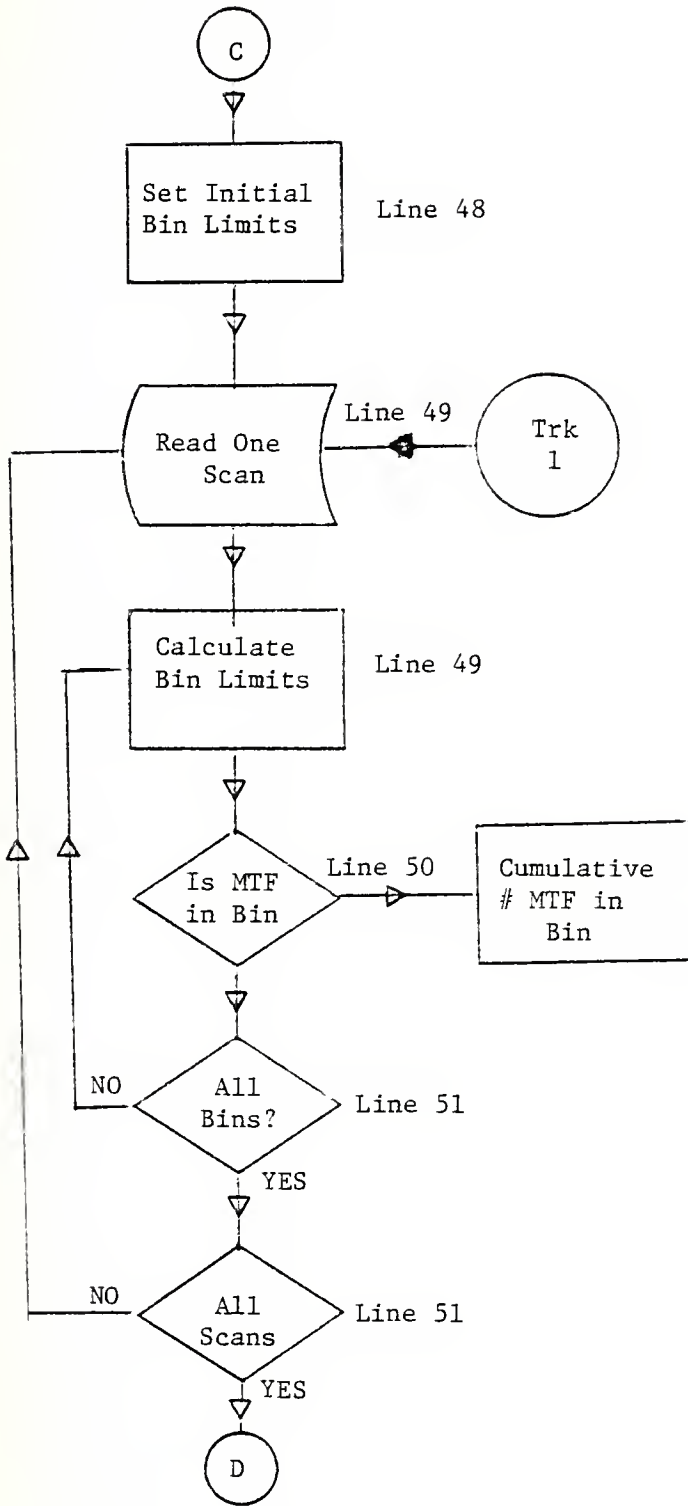

Figure 6C. Data Analysis Program

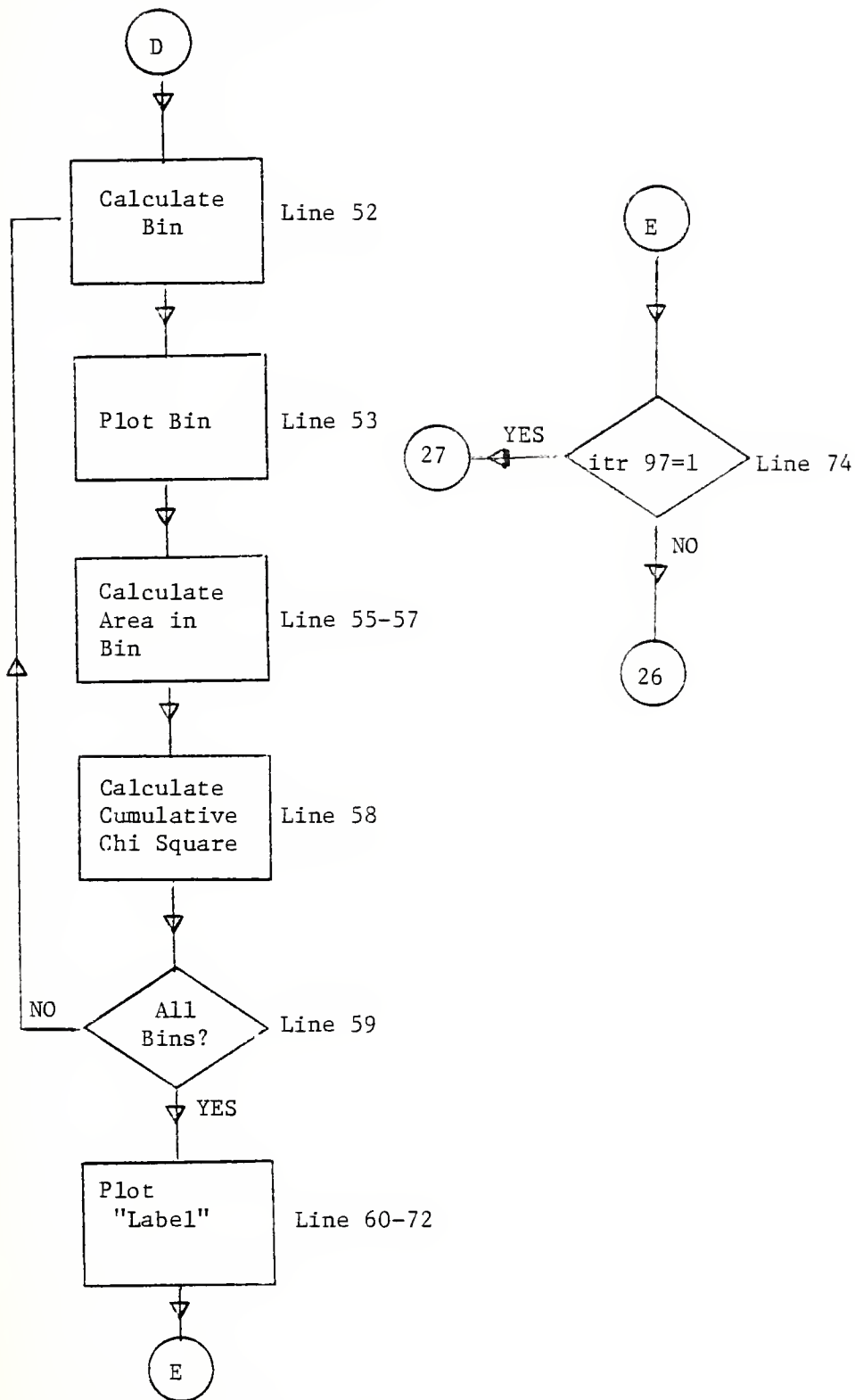

Figure 6D. Data Analysis Program

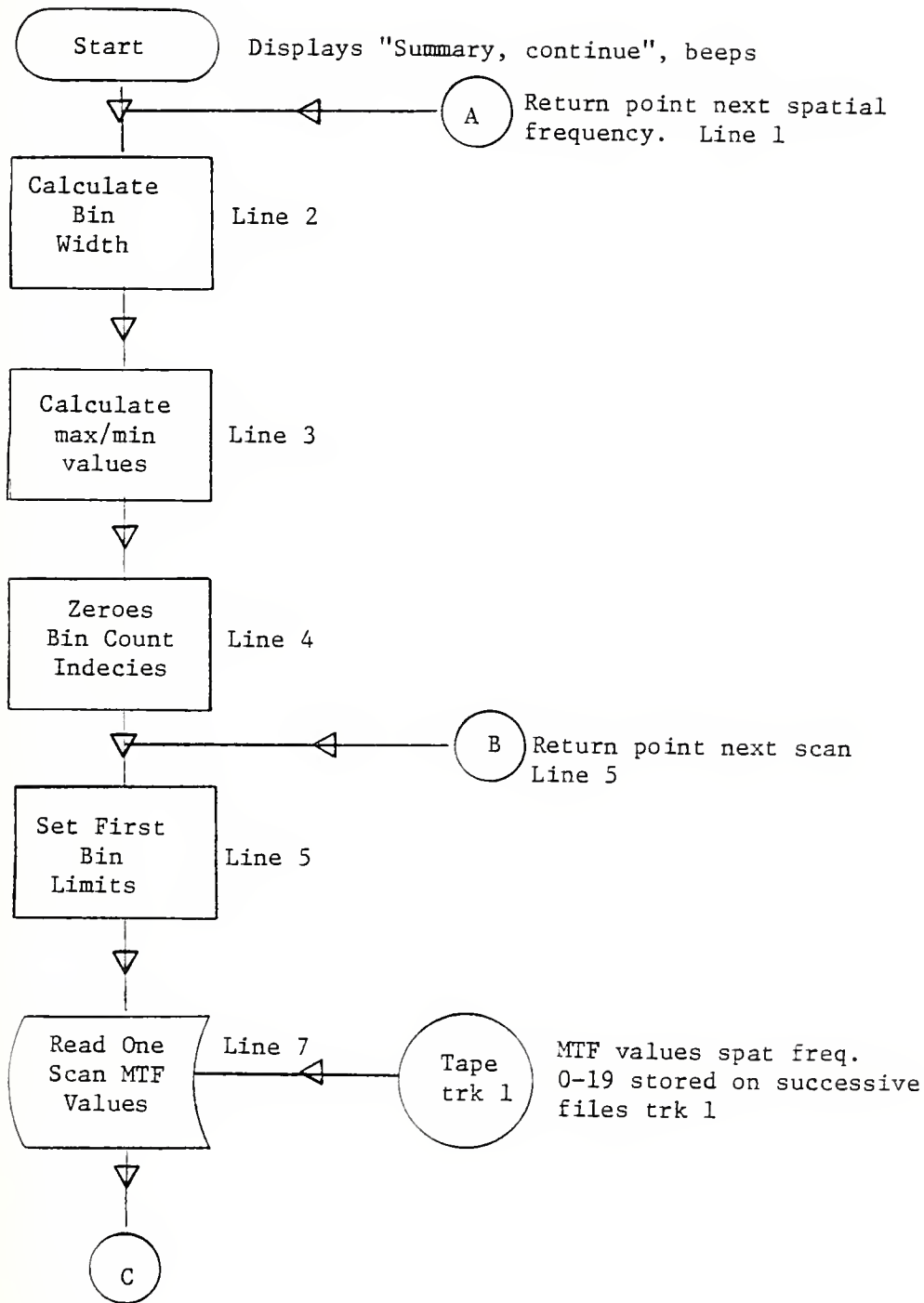

Figure 7A. Data Summary Program

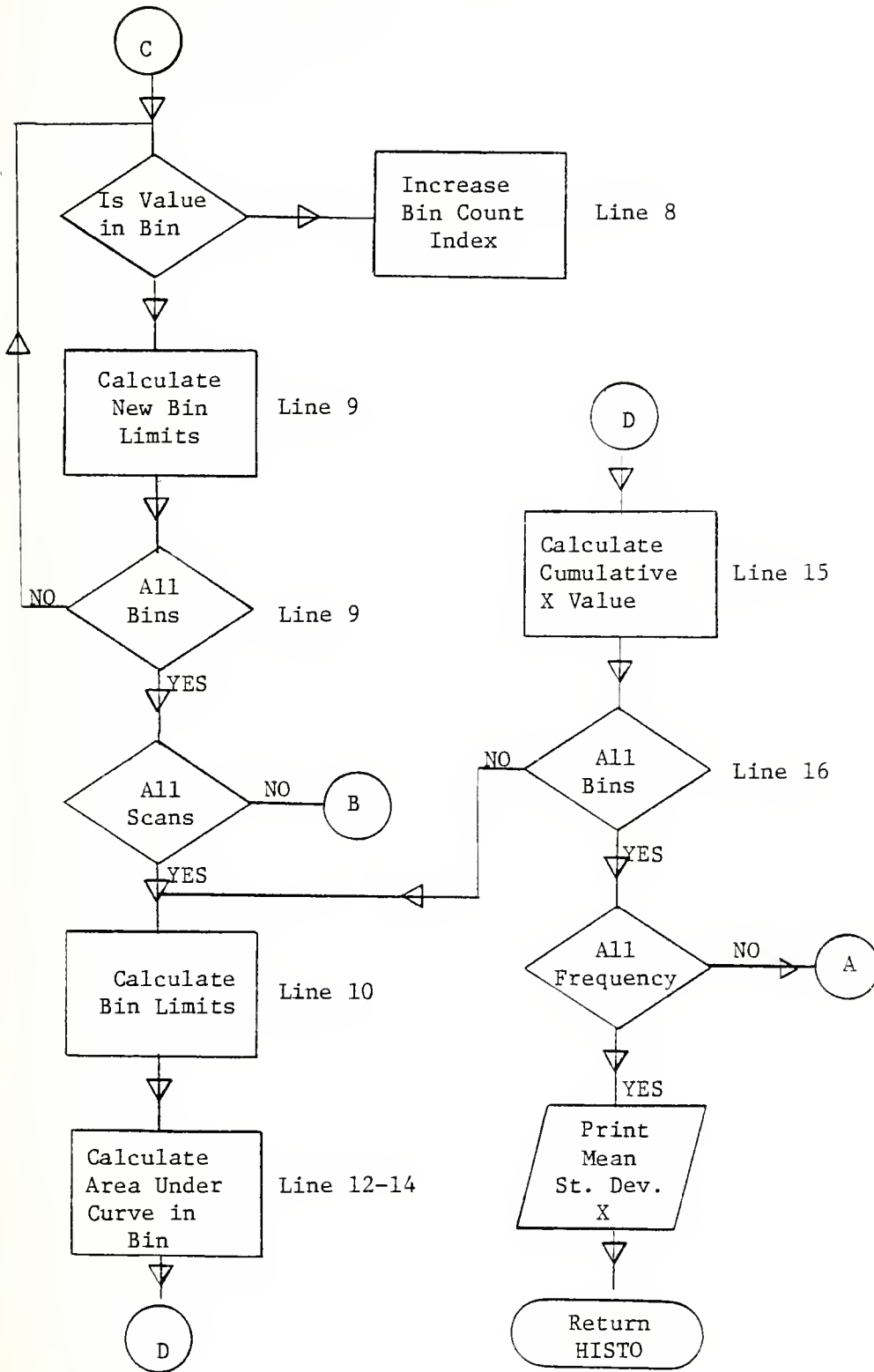

Figure 8B. Data Summary Program

III. RESULTS

A total of 24 data analysis runs have been performed. Five of these have been on the same data sets in order to investigate consistency of distribution within the same data set.

An arbitrary grading system for goodness of fit over a range of spatial frequencies has been established as follows:

- All components in range within 95 percentile = 1.
- One component in range outside 95 percentile = 2.
- Two or more components in range outside 95 percentile = 3.

Data summary and MTF mean and standard deviation plots are given on pages 39-86, arranged in order of decreasing order of Cn. A distribution analysis summary is tabulated on pages 31-33. A set of histograms for all spatial frequencies for one data set is given on pages 87-112.

A. CONSISTENCY OF DISTRIBUTION

Data set number 12 has been run 5 times to verify consistency of distribution as only every 25th scan was sampled.

Utilizing the grading system for spatial frequency ranges 0, 1-6, 7-12 and 13-19, the following results as given in Table II and III, were found:

TABLE I
DISTRUBTION ANALYSIS SUMMARY

Set No.	Cn	Date	Time	Spat. Freq.	Norm	Log Norm	Comments
1	1.04 10 ⁻⁷	031176	2320	0	1	1	0 freq. log data best fit
				1-6	1	1	
				7-12	1	1	
				13-19	2	3	
2	1.06 10 ⁻⁷	021877	1225	0	1	1	0 freq. normal data best fit
				1-6	1	1	
				7-12	2	3	
				13-19	3	3	
3	1.06 10 ⁻⁷	040276	1420	0	2	2	Large standard deviation
				1-6	3	3	
				7-12	3	3	
				13-19	3	3	
4	1.07 10 ⁻⁷	031176	2247	0	1	1	Good fit at low frequencies
				1-6	1	1	
				7-12	1	1	
				13-19	3	3	
5	1.67 10 ⁻⁷	031176	2205	0	1	1	0 freq. log data best fit
				1-6	1	2	
				7-12	1	2	
				13-19	2	3	
6	1.75 10 ⁻⁷	040276	1203	0	1	1	0 freq. log data best fit
				1-6	3	3	
				7-12	3	3	
				13-19	3	3	
7	2.79 10 ⁻⁸	092177	1555	0	2	1	
				1-6	3	3	
				7-12	3	1	
				13-19	3	1	
3	4.25 10 ⁻⁸	121776	1140	0	2	1	log data best fit
				1-6	3	1	
				7-12	3	3	
				13-19	3	3	

Legend: 1. All values within Chi Square 95 percentile.
 2. One value above Chi Square 95 percentile.
 3. Two or more values above Chi Square 95 percentile.

DISTRIBUTION ANALYSIS SUMMARY

Set No.	Cn	Date	Time	Spat. Freq.	Norm	Log Norm	Comments
9	5.03	092377	1452	0	1	2	0 freq. log data, chi sq. value 26.6
	10 ⁻⁸			1-6	2	1	
				7-12	3	3	
				13-19	3	2	
10	5.62	021877	1103	0	1	1	log data low chi sq. values
	10 ⁻⁸			1-6	1	1	
				7-12	2	1	
				13-19	3	2	
11	5.86	121776	1244	0	2	2	Absolute values low
	10 ⁻⁸			1-6	2	1	
				7-12	2	3	
				13-19	3	3	
12	5.89	092377	1522	0	2	1	This data set run 5 times to check consistency within data set
	10 ⁻⁸			1-6	3	1	
				7-12	3	1	
				13-19	3	1	
13	5.94	092277	1616	0	1	2	
	10 ⁻⁸			1-6	3	3	
				7-12	3	2	
				13-19	3	3	
14	6.08	092277	1705	0	1	1	log data range 0-8 low chi sq. values
	10 ⁻⁸			1-6	1	1	
				7-12	1	2	
				13-19	2	2	
15	6.92	121776	1012	0	1	1	log data good fit
	10 ⁻⁸			1-6	1	1	
				7-12	3	1	
				13-19	3	1	
16	6.99	021577	1700	0	2	2	
	10 ⁻⁸			1-6	2	3	
				7-12	3	3	
				13-19	1	3	

Legend: 1. All values within Chi Square 95 percentile.
 2. One value above Chi Square 95 percentile.
 3. Two or more values above Chi Square 95 percentile.

DISTRIBUTION ANALYSIS SUMMARY

Set No.	Cn	Date	Time	Spat. Freq.	Norm	Log Norm	Comments
17	7.28	021777	1900	0	1	1	
	10 ⁻⁸			1-6	1	1	
				7-12	3	3	
				13-19	3	2	
18	7.35	021877	1035	0	1	2	Large standard deviations.
	10 ⁻⁸			1-6	3	1	
				7-12	3	3	
				13-19	3	1	
19	8.23	021577	1635	0	2	2	Large standard deviations.
	10 ⁻⁸			1-6	2	2	
				7-12	3	3	
				13-19	3	3	
20	8.56	021577	1600	0	2	1	
	10 ⁻⁸			1-6	3	1	
				7-12	3	3	
				13-19	3	3	

Legend: 1. All values within Chi Square 95 percentile.
 2. One value above Chi Square 95 percentile.
 3. Two or more values above Chi Square 95 percentile.

TABLE II

Grading Consistency of Data from Same Data Set

Frequency Range	Number of Runs with Grading						
	Normal			Log Normal			
	Grade	1	2	3	1	2	3
0		1	4	0	4	1	0
1 - 6		1	0	4	5	0	0
7 - 12		0	0	5	3	1	1
13 - 19		0	0	5	3	2	0

The number of samples which met the 95 percentile criterion for each spatial frequency in the 0 - 6 frequency range is listed in Table III.

TABLE III

Consistency of Individual Frequency Components
from Samples of Same Data Set

Frequency	Number of Samples within 95%	
	Normal	Log Normal
0	1	4
1	1	5
2	2	5
3	3	5
4	3	5
5	2	5
6	3	5

The results indicate that the distribution can be expected to give same Chi Square values for different sample series from same data set.

B. FACTORS AFFECTING DISTRIBUTIONS

1. Scintillation

If the intensity of a laser beam which has propagated through a turbulent medium is observed at a point, the intensity appears to fluctuate or scintillate in a random way.

It has been shown that the values of the logarithm of the amplitude follow a Gaussian distribution (Ref. 1, page 15). Spatial frequency component zero represents the area under the curve (signal). This area is proportional to the received intensity. It is thus expected that the distribution of the zero spatial frequency component should fit the log normal distribution.

2. Signal to Noise Ratio

The amplitude of the spatial frequencies decreases with increasing frequency number. For spatial frequency 15 and above, the amplitude is of the order of 10% of the zero spatial frequency component. At higher frequencies noise will contribute more relative to the amplitude. Noise is considered normal distributed, and it is expected that the distribution at higher frequencies is normal.

C. RESULTS AND DISCUSSION

1. Log-Normal Distribution of 0 Spatial Frequency

In 13 of 20 runs the spatial frequency zero fits the Ln normal Chi Square 95 percentile criterion. For runs which

do not meet the distribution criterion, the ratio of mean to standard deviation is in the order of 2. This may indicate saturation, and thus not follow log normal distribution (Ref. 1, page 16).

The results do indicate that the zero spatial frequency is log normal distributed.

2. Normal Distribution of Higher Frequencies

For data analysis the modulus, e.g., absolute value of the data has been used, and sign of the data has not been included. This will introduce a skewness of distribution. It is believed that this is the reason for lack of normal distribution for data at higher frequencies.

3. Distribution versus Cn Value

Data have been arbitrarily grouped into ranges with respect to Cn values as follows:

Cn High: $Cn > 6.10^{-8}$

Cn Medium: Cn between 2.10^{-8} and 6.10^{-8}

Cn Low: $Cn < 2.10^{-8}$

The ratio of distributions graded 1 for the various Cn ranges is listed in Table IV.

The results do not indicate that the distribution does change with Cn values. For all analysis results, it should be noted that the sample size is small, and the results should be interpreted as indications only.

TABLE IV

Ratio of Distribution Graded
1 for Different Cn Ranges

Cn	Spatial Frequency	Normal	Log Normal
H	0	5/6	5/6
I	1 - 6	2/6	3/6
G	7 - 12	3/6	2/6
H	13 - 19	0/6	0/6
<hr/>			
M	0	3/7	4/7
E	1 - 6	1/7	5/7
D	7 - 12	0/7	3/7
I	13 - 19	0/7	2/7
U			
M			
<hr/>			
L	0	4/7	4/7
O	1 - 6	3/7	5/7
W	7 - 12	0/7	1/7
	13 - 19	1/7	2/7

D. RECOMMENDATIONS FOR FURTHER WORK

To reduce analysis computing time, the HP-9825 should be equipped with additional memory capacity. To eliminate use of tape for data storage, memory should be increased to 25K.

The data analysis for each run should be stored and analyzed for mean and standard deviation. Several runs on the same data set should be performed to verify distribution.

Number of scans sampled in each run should be increased by either solving signal trigger problem at low tape speed or by reprogramming NIC-80 computer to perform and store partial analysis results.

DATA SUMMARY

DATE 31176 TIME 2320

Cn 1.040 E-7 OPTICS 0.4572

SPAT FR	MEAN	ST. DEV	CHI SQ	TEST DIST LN NORMAL
0	1.72148E-01	3.31009E-02	1.84723E 01	1.24140E 01
1	1.79495E-01	2.67680E-02	1.19690E 01	1.02811E 01
2	1.63786E-01	2.33604E-02	1.67223E 01	1.12004E 01
3	1.53374E-01	2.33651E-02	1.69518E 01	1.81217E 01
4	1.33964E-01	2.09602E-02	1.63570E 01	1.62155E 01
5	1.20650E-01	2.10403E-02	1.68463E 01	1.36178E 01
6	1.01604E-01	1.93255E-02	1.64641E 01	1.60603E 01
7	8.94022E-02	1.96909E-02	2.24854E 01	1.61994E 01
8	7.54947E-02	1.86066E-02	1.02836E 01	2.54769E 01
9	6.50425E-02	1.82109E-02	1.92331E 01	1.85141E 01
10	5.42552E-02	1.80097E-02	1.87193E 01	2.91390E 01
11	4.71915E-02	1.71278E-02	1.52059E 01	2.27245E 01
12	3.99097E-02	1.64946E-02	1.23264E 01	1.83873E 01
13	3.42307E-02	1.47938E-02	1.84042E 01	3.36639E 01
14	3.04063E-02	1.41907E-02	1.98840E 01	1.84063E 01
15	2.59706E-02	1.27142E-02	3.33620E 01	1.67758E 01
16	2.41839E-02	1.27317E-02	2.85153E 01	1.58852E 01
17	2.10091E-02	1.11712E-02	1.99408E 01	1.53447E 01
18	2.01263E-02	1.02553E-02	1.74080E 01	2.38480E 01
19	1.89340E-02	9.87057E-03	2.26053E 01	3.25991E 01

MTF MEAN AND \pm 1 STANDARD DEVIATION
 DATE 31176 TIME 2320 NO OF SCANS 115
 WAVELENGTH 0.6320 OPTICS 0.4572
 CN 1.040E-7

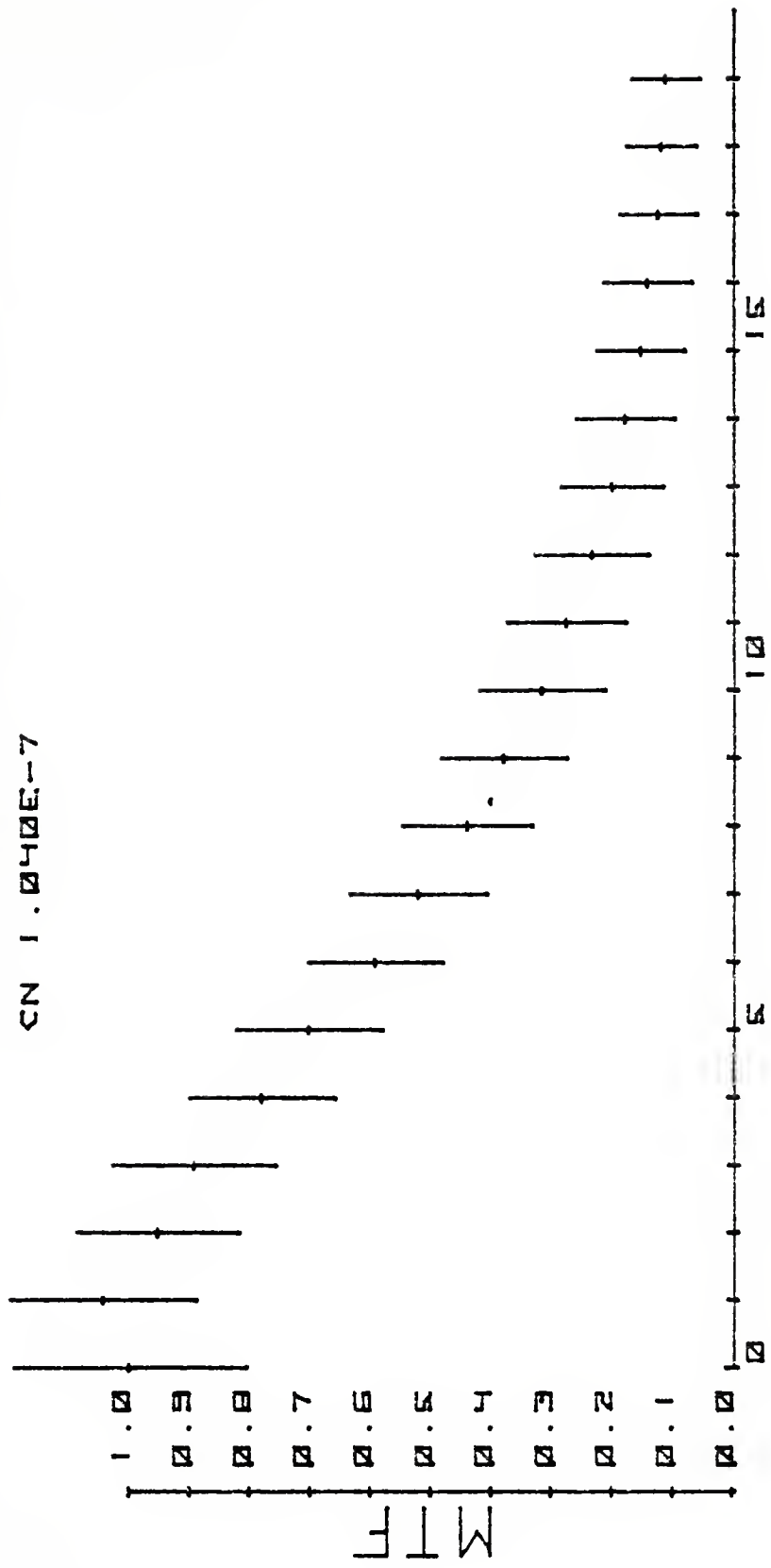

SPATIAL FREQUENCY IN 1 / MILLIRADIANS

DATA SUMMARY

DATE 21877 TIME 1225
 Cn 1.060 E-7 OPTICS 0.4572

SPAT FR	MEAN	ST. DEV	TEST DIST. NORMAL		TEST DIST LN NORMAL	
			CHI SQ	CHI SQ	CHI SQ	CHI SQ
0	4.05226E-02	1.23482E-02	1.57348E 01	1.80814E 01		
1	3.40039E-02	8.05773E-03	1.94884E 01	2.22370E 01		
2	2.66171E-02	7.00750E-03	1.83489E 01	1.64396E 01		
3	2.20229E-02	5.52957E-03	1.60839E 01	2.18722E 01		
4	1.70408E-02	4.57584E-03	1.54299E 01	2.11065E 01		
5	1.29465E-02	3.92677E-03	1.33749E 01	2.08710E 01		
6	9.98770E-03	3.44010E-03	2.49503E 01	2.03598E 01		
7	8.86402E-03	3.14798E-03	1.44858E 01	2.45723E 01		
8	8.71565E-03	2.99477E-03	2.75390E 01	1.73797E 01		
9	8.19202E-03	2.70054E-03	1.55284E 01	2.56119E 01		
10	7.68941E-03	2.58417E-03	1.36396E 01	2.90795E 01		
11	7.18604E-03	2.48700E-03	2.01411E 01	3.86319E 01		
12	6.31642E-03	2.31861E-03	1.82465E 01	2.94774E 01		
13	4.58711E-03	1.83204E-03	1.24531E 01	4.57692E 01		
14	3.43285E-03	1.69846E-03	2.09487E 01	3.36265E 01		
15	3.23270E-03	1.82699E-03	3.26177E 01	3.00948E 01		
16	2.64151E-03	1.51815E-03	2.85289E 01	4.87885E 01		
17	1.36630E-03	9.13203E-04	2.72719E 01	5.94658E 01		
18	1.24776E-03	8.31263E-04	2.96239E 01	4.71448E 01		
19	1.24225E-03	7.32456E-04	2.64523E 01	2.20641E 01		

MTF MEAN AND \pm 1 STANDARD DEVIATION

DATE 21877 TIME 1225 NO OF SCANS 125

WAVELENGTH 0.6328 OPTICS 0.4572

CN 1.060E-7

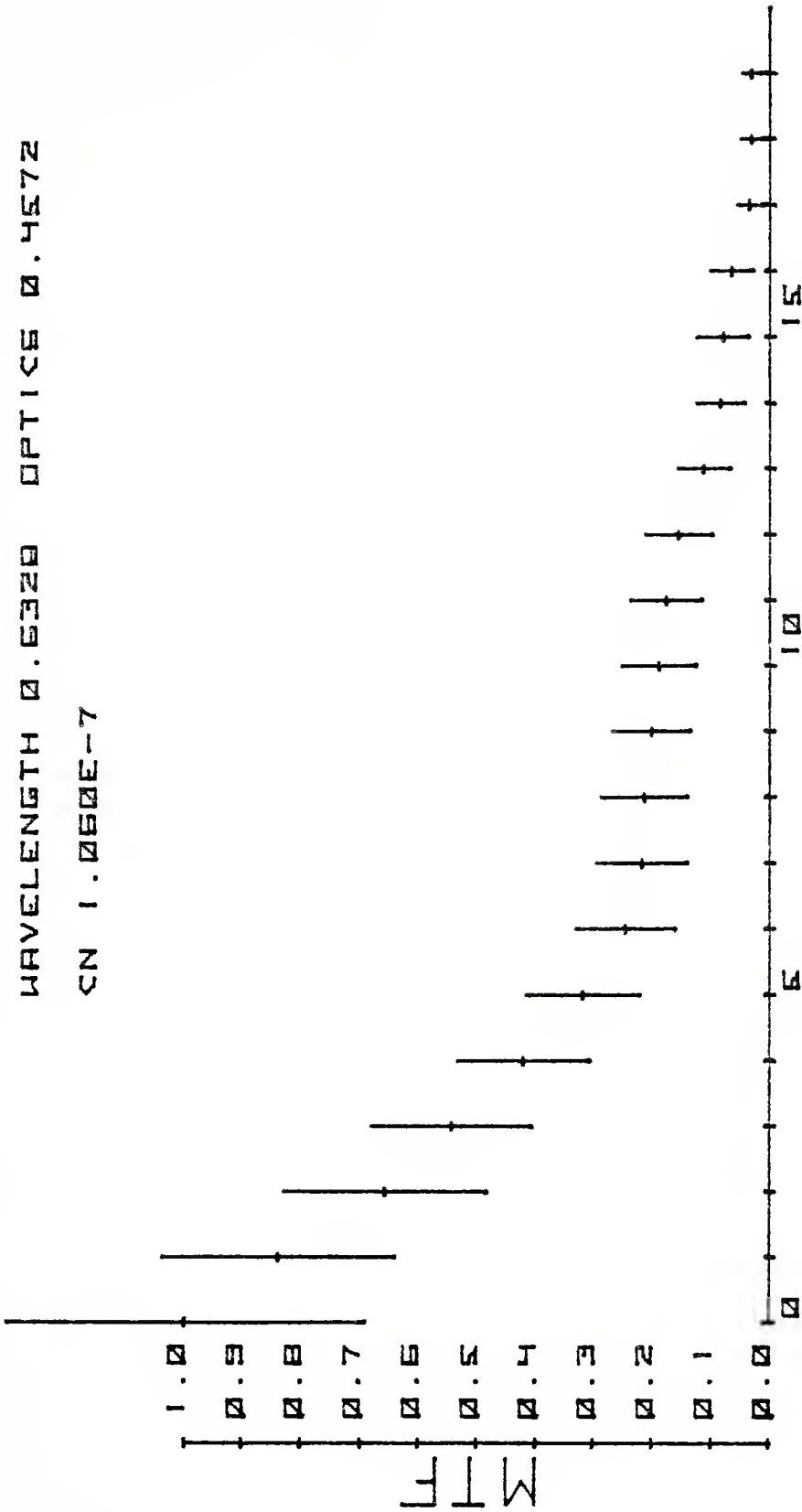

SPATIAL FREQUENCY IN 1 / MILLIRADIANS

DATA SUMMARY

DATE 40276 TIME 1420

Cn 1.060 E-7 OPTICS 0.4572

TEST DIST. NORMAL			TEST DIST LN NORMAL		
SPAT FR	MEAN	ST. DEV	CHI SQ	CHI SQ	
0	5.60682E-02	3.03467E-02	2.61703E 01	3.69806E 01	
1	5.01330E-02	2.23766E-02	2.76150E 01	1.36740E 01	
2	3.79662E-02	1.75518E-02	3.88568E 01	1.41279E 01	
3	2.56394E-02	1.36391E-02	3.53159E 01	1.85502E 01	
4	1.59020E-02	1.00080E-02	3.38714E 01	2.07429E 01	
5	1.04380E-02	7.63761E-03	4.39702E 01	2.58036E 01	
6	7.85992E-03	5.48321E-03	3.90323E 01	5.49170E 01	
7	5.62665E-03	3.78506E-03	3.55105E 01	3.62795E 01	
8	4.82013E-03	2.90451E-03	2.82683E 01	2.25957E 01	
9	4.74550E-03	2.94044E-03	2.89242E 01	4.51894E 01	
10	4.76253E-03	2.48134E-03	2.14377E 01	2.03942E 01	
11	5.04598E-03	2.81717E-03	2.41677E 01	2.66833E 01	
12	4.55518E-03	2.30284E-03	1.88842E 01	3.72447E 01	
13	4.96160E-03	2.69563E-03	2.32494E 01	1.62133E 01	
14	5.30088E-03	2.94666E-03	2.35794E 01	4.21361E 01	
15	5.43028E-03	2.88695E-03	3.24202E 01	3.84611E 01	
16	5.48871E-03	2.99280E-03	2.89751E 01	2.57013E 01	
17	5.27463E-03	3.31892E-03	3.46644E 01	2.37540E 01	
18	5.68553E-03	3.20093E-03	2.70948E 01	3.90183E 01	
19	5.70921E-03	2.81319E-03	1.92965E 01	2.96202E 01	

MTF MEAN AND ± 1 STANDARD DEVIATION
 DATE 40276 TIME 1420 NO OF SCANS 120
 WAVELENGTH 0.6328 OPTICS 0.4572
 CN 1.060E-7

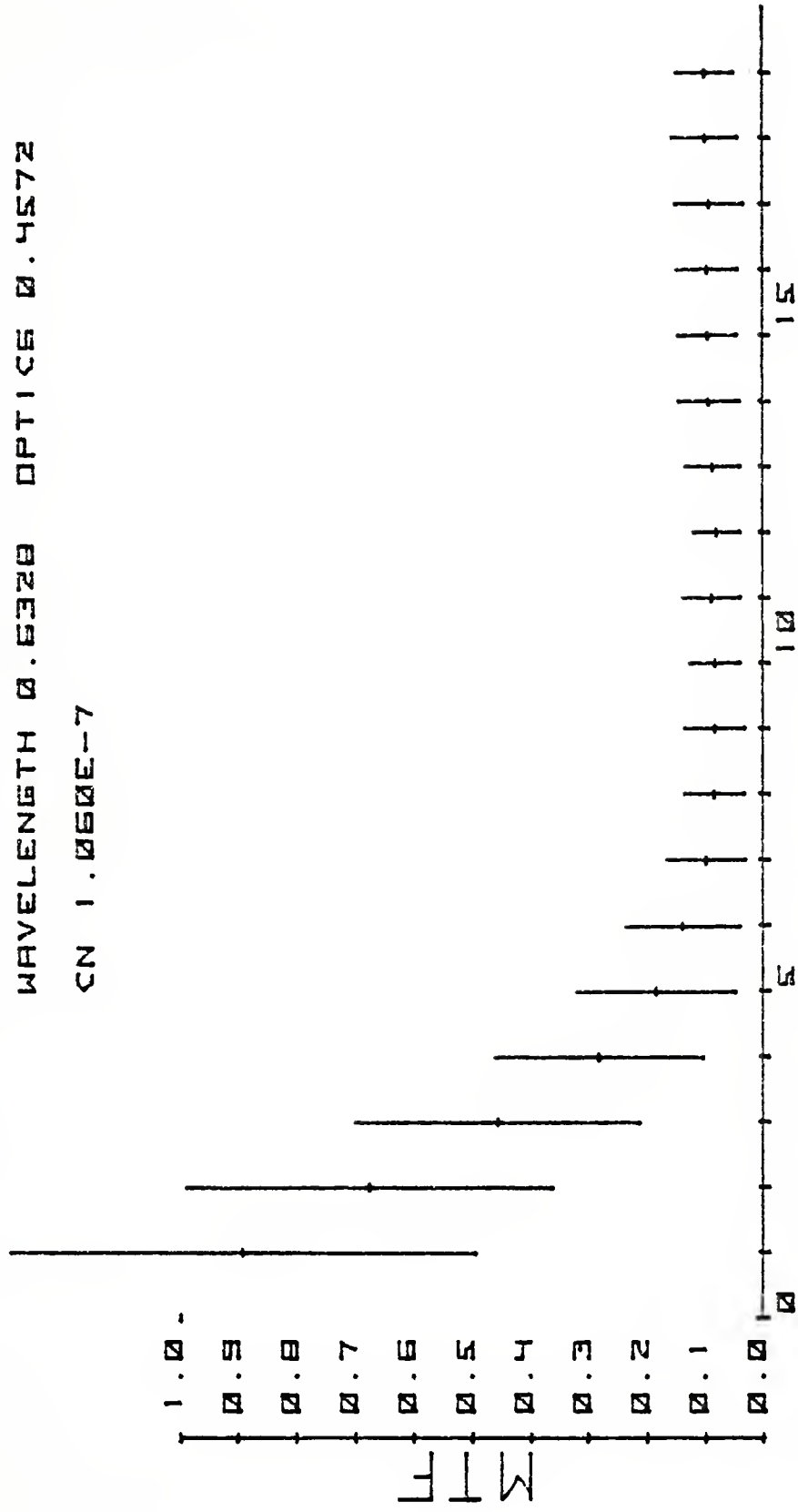

SPATIAL FREQUENCY IN 1 / MILLIRADIANS

DATA SUMMARY

DATE 31176 TIME 2247

Cn 1.070 E-7 OPTICS 0.4572

SPAT FR	MEAN	ST. DEV	CHI SQ	TEST DIST LN NORMAL
0	1.57180E-01	3.07251E-02	1.06859E 01	1.09378E 01
1	1.58314E-01	3.07646E-02	1.40924E 01	1.42350E 01
2	1.43959E-01	2.78940E-02	1.56449E 01	2.00447E 01
3	1.29452E-01	2.59748E-02	9.01072E 00	1.07942E 01
4	1.10304E-01	2.29526E-02	1.80094E 01	1.32954E 01
5	9.55205E-02	2.18780E-02	1.19267E 01	9.82610E 00
6	7.78679E-02	1.97953E-02	1.36402E 01	7.92677E 00
7	6.62221E-02	1.87789E-02	2.10546E 01	1.06681E 01
8	5.36158E-02	1.73492E-02	1.96589E 01	1.24204E 01
9	4.56103E-02	1.67074E-02	1.96931E 01	1.50339E 01
10	3.65379E-02	1.55389E-02	2.09631E 01	1.85732E 01
11	3.18825E-02	1.48605E-02	1.43609E 01	1.80623E 01
12	2.59730E-02	1.32646E-02	2.24578E 01	2.31134E 01
13	2.29490E-02	1.24291E-02	2.58378E 01	2.19008E 01
14	1.92865E-02	1.11348E-02	2.63962E 01	3.37874E 01
15	1.73488E-02	1.01426E-02	3.15511E 01	1.85470E 01
16	1.57564E-02	9.27992E-03	3.71499E 01	1.32958E 01
17	1.45254E-02	8.34266E-03	3.06972E 01	1.94406E 01
18	1.38418E-02	8.37420E-03	4.91633E 01	2.22204E 01
19	1.30450E-02	7.94954E-03	3.52109E 01	2.75267E 01

MTF MEAN AND ± 1 STANDARD DEVIATION
 DATE 31176 TIME 2247 NO OF SCANS 100
 WAVELENGTH 0.6328 OPTICS 0.4572
 CN 1.070E-7

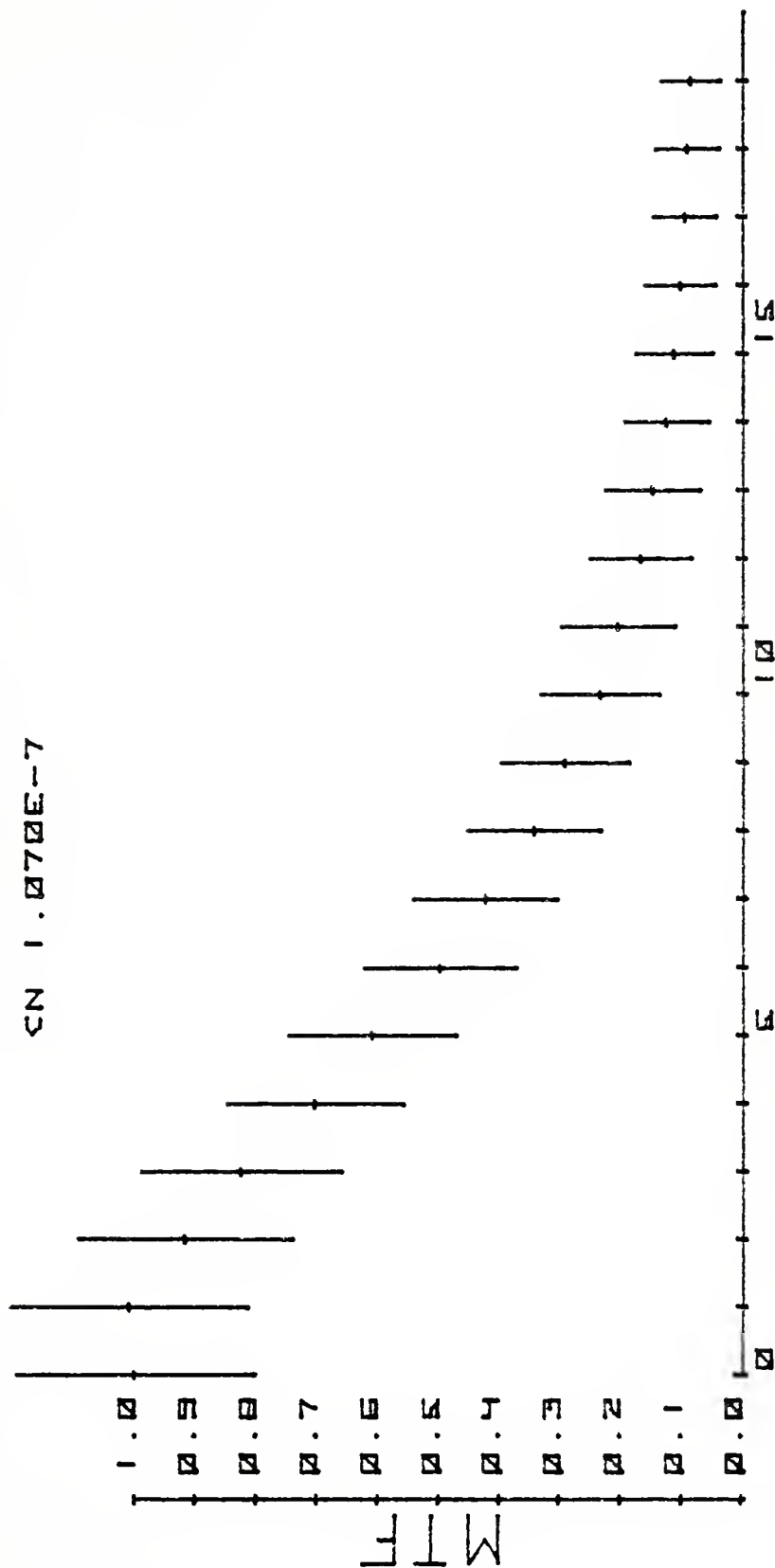

SPATIAL FREQUENCY IN 1 / MILLIRADIANS

DATA SUMMARY

DATE 31176 TIME 2205

Cn 1.670 E-7 OPTICS 0.4572

SPAT FR	TEST DIST. NORMAL		TEST DIST LN NORMAL	
	MEAN	ST. DEV	CHI SQ	CHI SQ
0	9.34088E-02	1.69040E-02	1.92354E 01	1.74386E 01
1	9.41831E-02	1.76651E-02	1.78344E 01	1.74408E 01
2	8.81858E-02	1.66999E-02	1.13990E 01	1.83154E 01
3	8.00763E-02	1.53372E-02	1.68854E 01	2.59774E 01
4	7.17458E-02	1.46835E-02	2.46704E 01	1.90874E 01
5	6.28037E-02	1.38628E-02	1.47124E 01	1.68485E 01
6	5.37725E-02	1.27935E-02	8.64639E 00	1.51700E 01
7	4.62891E-02	1.15746E-02	1.69692E 01	1.95988E 01
8	3.89583E-02	1.12611E-02	1.49340E 01	1.60089E 01
9	3.28095E-02	1.04669E-02	9.09879E 00	1.31090E 01
10	2.71688E-02	1.01800E-02	1.55086E 01	1.74091E 01
11	2.28744E-02	9.66094E-03	1.78171E 01	1.53833E 01
12	1.94040E-02	9.21276E-03	2.08338E 01	2.77050E 01
13	1.68219E-02	8.81035E-03	1.87052E 01	2.90536E 01
14	1.43163E-02	7.93694E-03	2.17179E 01	2.50440E 01
15	1.30266E-02	7.31972E-03	2.20026E 01	2.19677E 01
16	1.22922E-02	6.41645E-03	2.03005E 01	1.48299E 01
17	1.08724E-02	6.35206E-03	3.12406E 01	1.58933E 01
18	1.05216E-02	6.05103E-03	1.81665E 01	2.84433E 01
19	1.01109E-02	5.38073E-03	2.17899E 01	2.73870E 01

MTF MEAN AND ± 1 STANDARD DEVIATION
 DATE 31176 TIME 2205 NO OF SCANS 100
 WAVELENGTH 0.6320 OPTICS 0.4572
 CN 1.670E-7

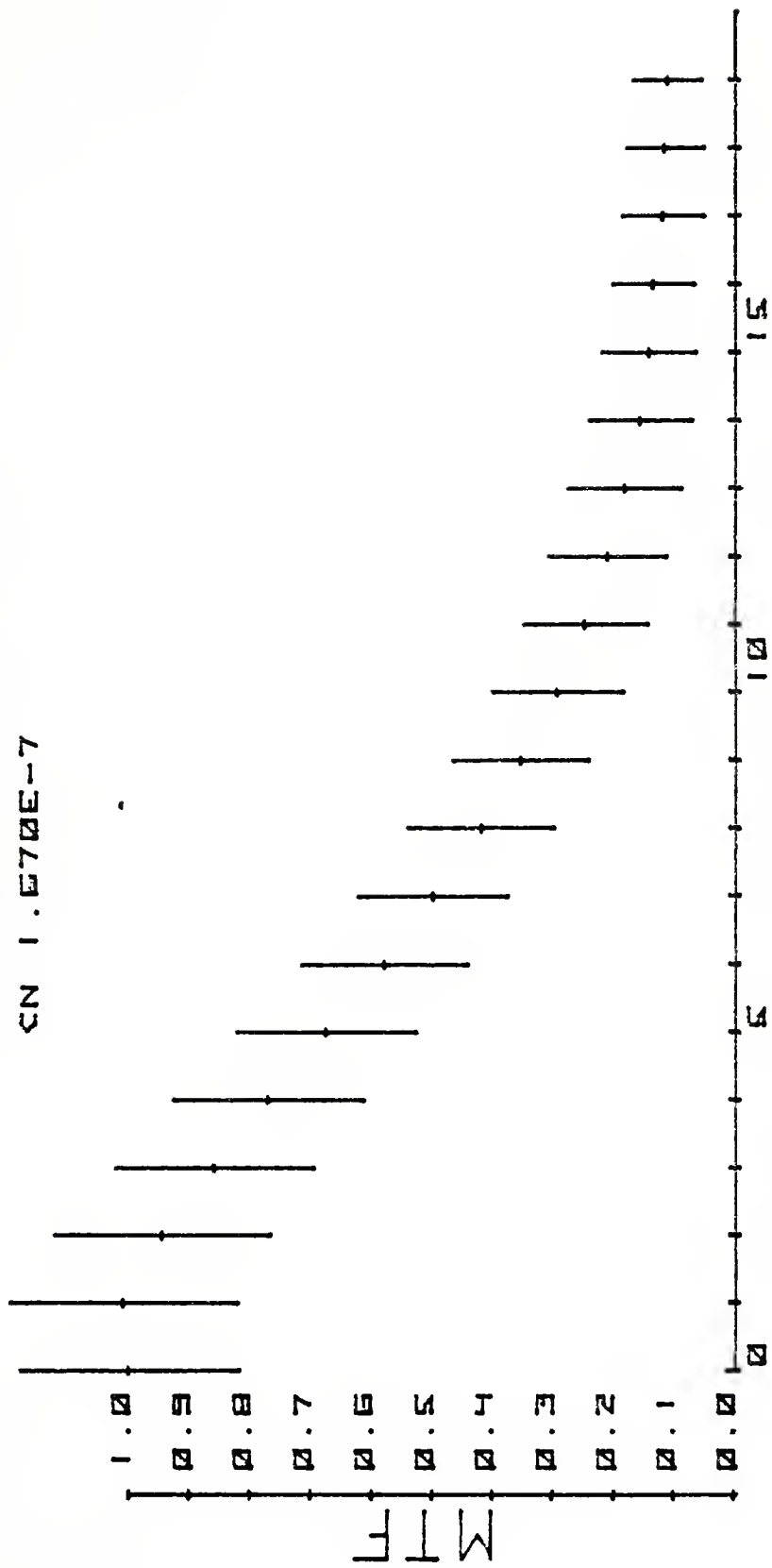

SPATIAL FREQUENCY IN 1 / MILLIRADIANS

DATA SUMMARY

DATE 40276 TIME 1203

Cn 1.750 E-7 OPTICS 0.4572

TEST DIST LN NORMAL

TEST DIST. NORMAL

SPAT FR	MEAN	ST. DEV	CHI SQ	CHI SQ
0	6.98996E-01	1.59671E-01	1.63495E 01	1.40670E 01
1	5.25582E-01	1.16328E-01	2.12457E 01	1.70746E 01
2	1.95906E-01	5.89321E-02	2.07592E 01	2.71094E 01
3	6.63378E-02	3.38567E-02	2.93826E 01	1.27823E 01
4	4.61421E-02	2.80058E-02	3.73464E 01	1.38709E 01
5	3.99425E-02	2.15245E-02	2.90810E 01	3.01576E 01
6	3.54626E-02	1.89246E-02	2.19977E 01	3.43120E 01
7	3.08721E-02	1.83749E-02	3.95675E 01	2.07877E 01
8	2.47349E-02	1.47364E-02	4.17132E 01	2.24285E 01
9	1.93527E-02	1.14947E-02	2.66967E 01	2.67202E 01
10	1.86085E-02	1.18740E-02	4.03211E 01	1.86967E 01
11	1.71758E-02	9.75988E-03	2.98580E 01	2.26418E 01
12	1.60030E-02	9.47672E-03	3.15453E 01	3.80947E 01
13	1.55573E-02	8.74021E-03	2.12925E 01	4.03882E 01
14	1.47034E-02	9.50145E-03	2.98689E 01	1.83592E 01
15	1.50193E-02	8.07504E-03	1.98141E 01	1.89574E 01
16	1.54534E-02	8.06747E-03	2.13201E 01	3.49211E 01
17	1.40634E-02	7.51993E-03	2.41140E 01	4.29951E 01
18	1.61416E-02	8.58549E-03	3.20453E 01	2.40438E 01
19	1.59116E-02	7.88841E-03	2.01704E 01	2.80724E 01

MTF MEAN AND + - 1 STANDARD DEVIATION
 DATE 40276 TIME 1203 NO OF SCANS 125
 WAVELENGTH 0.6328 OPTICS 0.4572
 CN 1.750E-7

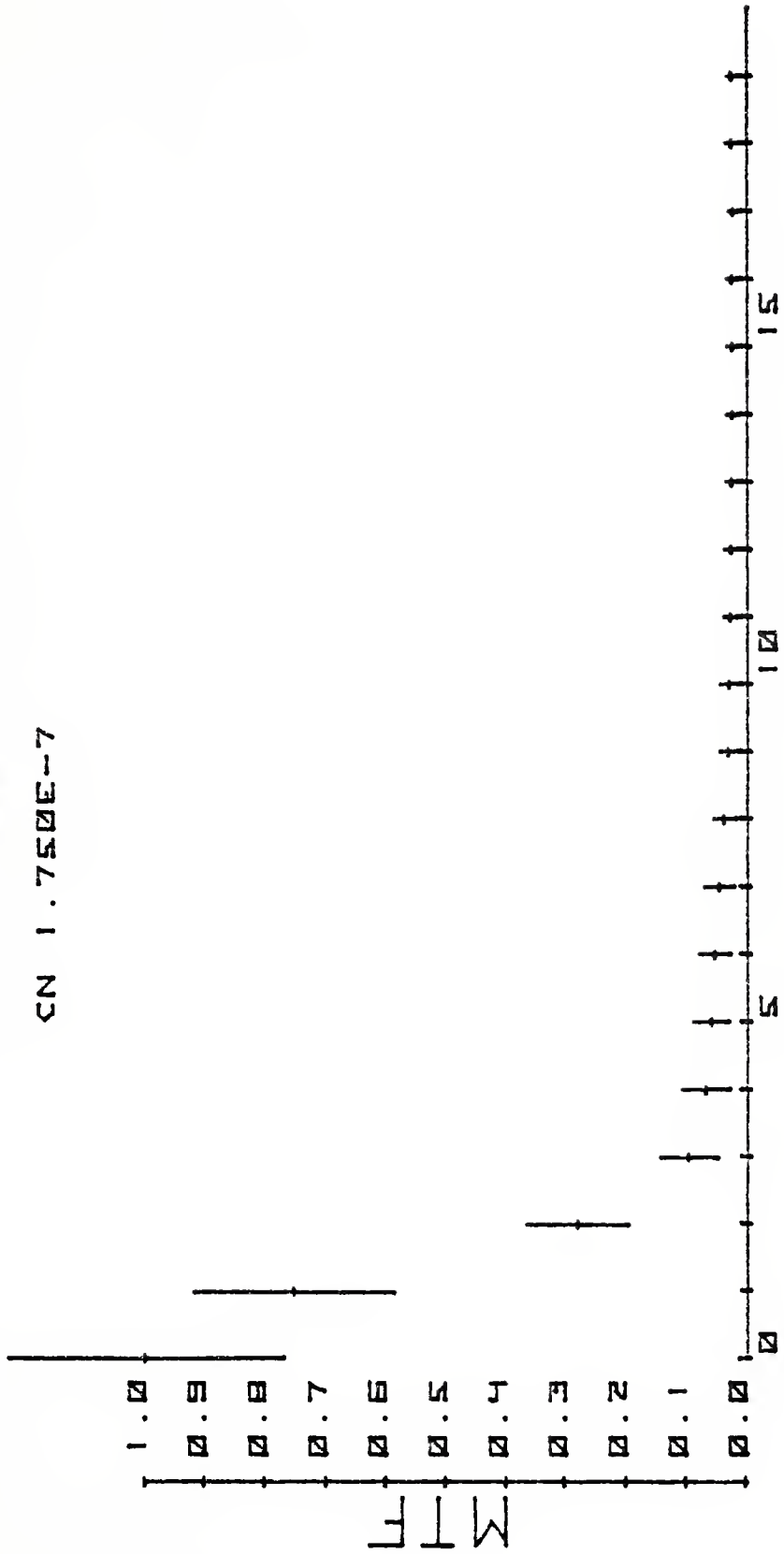

SPATIAL FREQUENCY IN 1 / MILLIRADIANS

DATA SUMMARY

DATE 92177 TIME 1555

Cn 2.790 E-8 OPTICS 0.4572

TEST DIST LN NORMAL

TEST DIST. NORMAL.

SPAT FR	MEAN	ST. DEV	CHI SQ	CHI SQ
0	5.96432E-02	2.13149E-02	2.50799E 01	2.08758E 01
1	5.85453E-02	1.92726E-02	2.76983E 01	2.65750E 01
2	5.71572E-02	1.88250E-02	2.50227E 01	3.13476E 01
3	5.65614E-02	1.86214E-02	3.08980E 01	3.84055E 01
4	5.45106E-02	1.81653E-02	2.88112E 01	2.24956E 01
5	5.34043E-02	1.77426E-02	2.86308E 01	2.70611E 01
6	5.10345E-02	1.72959E-02	2.19280E 01	3.49670E 01
7	4.92243E-02	1.67257E-02	3.22522E 01	2.40727E 01
8	4.68538E-02	1.61444E-02	1.98058E 01	2.01919E 01
9	4.52888E-02	1.55913E-02	2.46786E 01	2.33667E 01
10	4.28157E-02	1.50546E-02	2.48792E 01	1.95661E 01
11	4.09839E-02	1.49076E-02	2.41547E 01	1.82347E 01
12	3.88307E-02	1.44746E-02	2.73854E 01	1.69891E 01
13	3.70327E-02	1.41457E-02	2.93271E 01	1.76772E 01
14	3.45129E-02	1.38069E-02	1.73061E 01	1.77865E 01
15	3.25474E-02	1.38318E-02	2.05478E 01	1.22115E 01
16	3.11232E-02	1.35534E-02	2.21258E 01	1.71241E 01
17	2.91681E-02	1.30149E-02	2.54938E 01	1.53325E 01
18	2.80778E-02	1.30759E-02	3.67952E 01	1.37615E 01
19	2.62632E-02	1.29964E-02	4.01706E 01	2.06506E 01

MTF MEAN AND ± 1 STANDARD DEVIATION
 DATE 92177 TIME 1555 NO OF SCANS 100
 WAVELENGTH 0.6328 OPTICS 0.4572

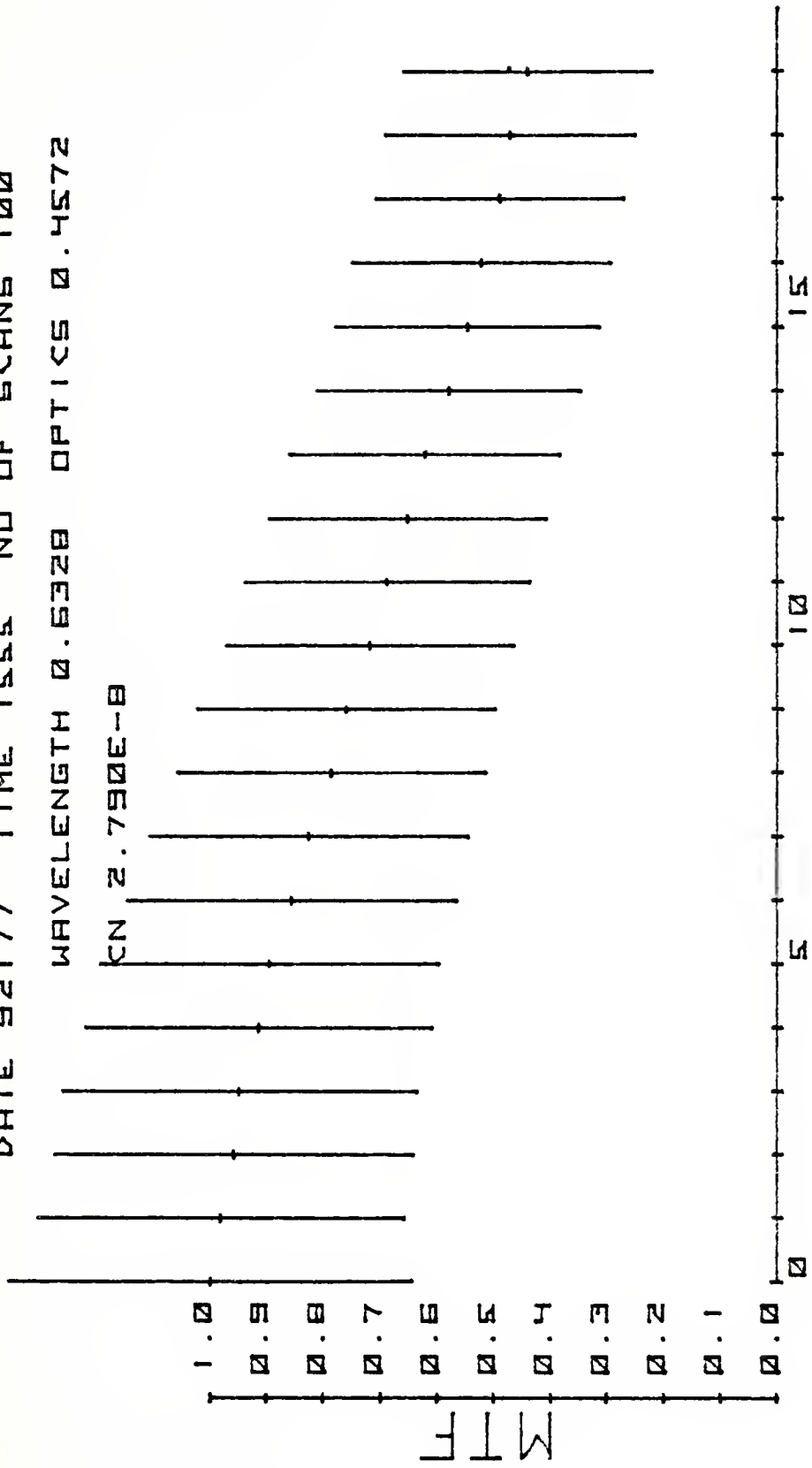

SPATIAL FREQUENCY IN 1 / MILLIRADIANS

DATA SUMMARY

DATE 121776 TIME 1140

Cn 4.250 E-8 OPTICS 0.4572

TEST DIST. NORMAL				TEST DIST LN NORMAL			
SPAT FR	MEAN	ST. DEV	CHI SQ	SPAT FR	MEAN	ST. DEV	CHI SQ
0	2.08124E-02	1.14518E-02	3.30404E 01	0	1.95001E 01		
1	1.93606E-02	1.00429E-02	4.74817E 01	1	2.04067E 01		
2	1.77361E-02	9.77940E-03	4.68337E 01	2	1.40419E 01		
3	1.69890E-02	9.15926E-03	3.61824E 01	3	1.92864E 01		
4	1.58967E-02	8.65183E-03	3.48949E 01	4	1.69226E 01		
5	1.41816E-02	8.05097E-03	3.64147E 01	5	2.13739E 01		
6	1.29556E-02	7.46749E-03	4.30527E 01	6	1.40243E 01		
7	1.15271E-02	6.72374E-03	4.34484E 01	7	1.75839E 01		
8	1.07336E-02	6.35428E-03	3.94947E 01	8	2.46444E 01		
9	9.30168E-03	5.90859E-03	4.11331E 01	9	1.71982E 01		
10	8.44874E-03	5.37074E-03	4.10516E 01	10	2.84317E 01		
11	7.05451E-03	4.83489E-03	4.10154E 01	11	2.85813E 01		
12	6.85106E-03	4.58273E-03	3.94723E 01	12	3.97229E 01		
13	5.49479E-03	4.10135E-03	4.27087E 01	13	1.93373E 01		
14	5.18333E-03	3.91018E-03	4.07578E 01	14	3.14192E 01		
15	4.76864E-03	3.64255E-03	5.52889E 01	15	2.05602E 01		
16	4.37101E-03	3.22247E-03	4.36789E 01	16	2.62436E 01		
17	3.51819E-03	2.95652E-03	5.32467E 01	17	2.28068E 01		
18	3.26155E-03	2.92397E-03	4.60261E 01	18	3.02668E 01		
19	2.96651E-03	2.44019E-03	6.41558E 01	19	1.94043E 01		

MTF MEAN AND \pm 1 STANDARD DEVIATION
 DATE 121776 TIME 1140 NO OF SCANS 126
 WAVELENGTH 0.6328 OPTICS 0.4572
 CN 4.260E-8

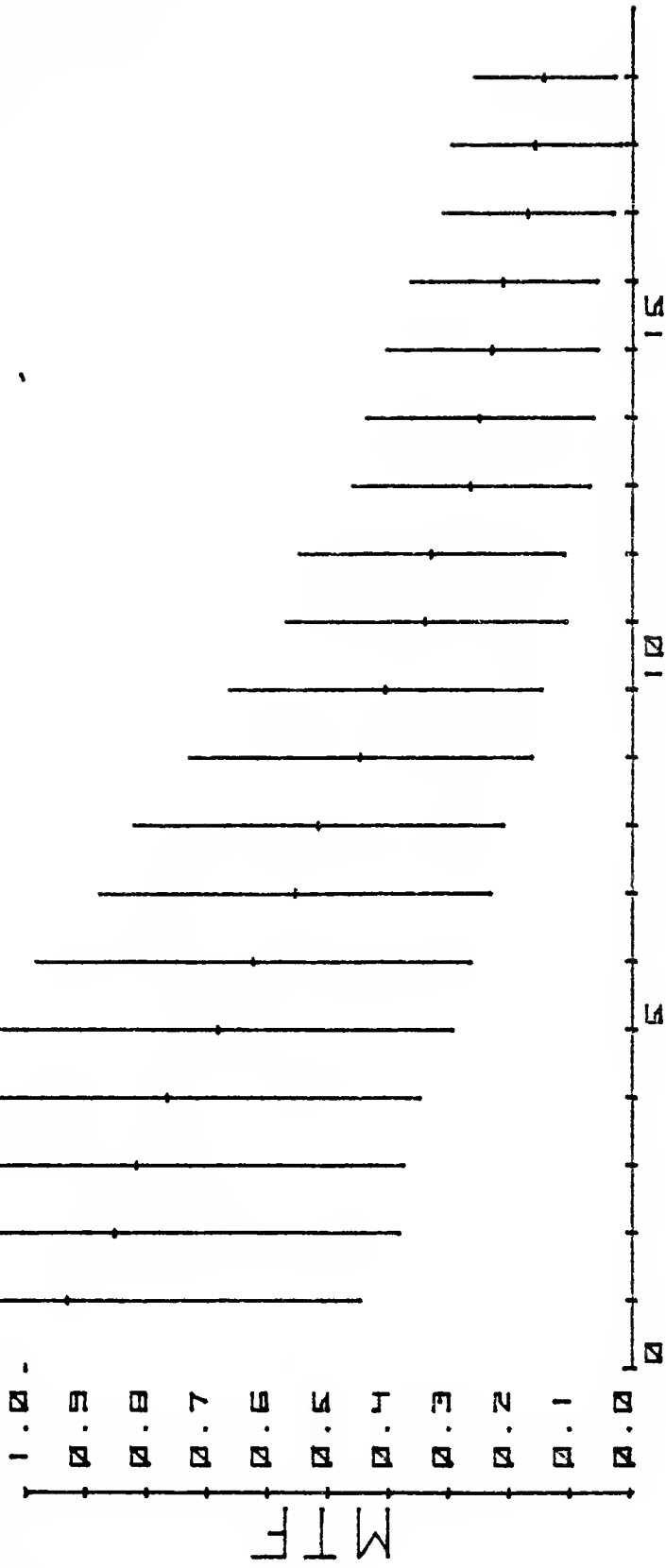

SPATIAL FREQUENCY IN 1 / MILLIRADIANS

DATA SUMMARY

DATE 92377 TIME 1452

Cn 5.030 E-8 OPTICS 0.4572

TEST DIST. NORMAL TEST DIST LN NORMAL

SPAT FR	MEAN	ST. DEV	CHI SQ	CHI SQ
0	6.73651E-02	2.64332E-02	1.84046E 01	2.66190E 01
1	6.45442E-02	2.43162E-02	1.70847E 01	1.60556E 01
2	6.04425E-02	2.32576E-02	2.28625E 01	1.65161E 01
3	5.63376E-02	2.16694E-02	2.04783E 01	1.48688E 01
4	5.06809E-02	1.96531E-02	2.45814E 01	1.16814E 01
5	4.48781E-02	1.81239E-02	2.33558E 01	1.14891E 01
6	3.87460E-02	1.62411E-02	2.88091E 01	9.12259E 00
7	3.35947E-02	1.45448E-02	2.02954E 01	9.90158E 00
8	2.88719E-02	1.33320E-02	2.20266E 01	8.69175E 00
9	2.44203E-02	1.21161E-02	2.39867E 01	1.42964E 01
10	2.05389E-02	1.09888E-02	2.14325E 01	1.82112E 01
11	1.76008E-02	9.87924E-03	3.27140E 01	4.62303E 01
12	1.54079E-02	9.30362E-03	3.38384E 01	2.81940E 01
13	1.28437E-02	8.14282E-03	2.50927E 01	2.94331E 01
14	1.15328E-02	7.81833E-03	3.02464E 01	1.35595E 01
15	1.03617E-02	6.80694E-03	3.75063E 01	2.09367E 01
16	9.77776E-03	6.72643E-03	3.27833E 01	1.32964E 01
17	8.35941E-03	6.06601E-03	3.82086E 01	2.07681E 01
18	8.07033E-03	5.66887E-03	3.30487E 01	2.07451E 01
19	7.68824E-03	5.14954E-03	3.35509E 01	1.79877E 01

MTF MEAN AND ± 1 STANDARD DEVIATION
 DATE 92377 TIME 1452 NO OF SCANS 100
 WAVELENGTH 0.6328 OPTICS 0.4572
 CN 5.030E-8

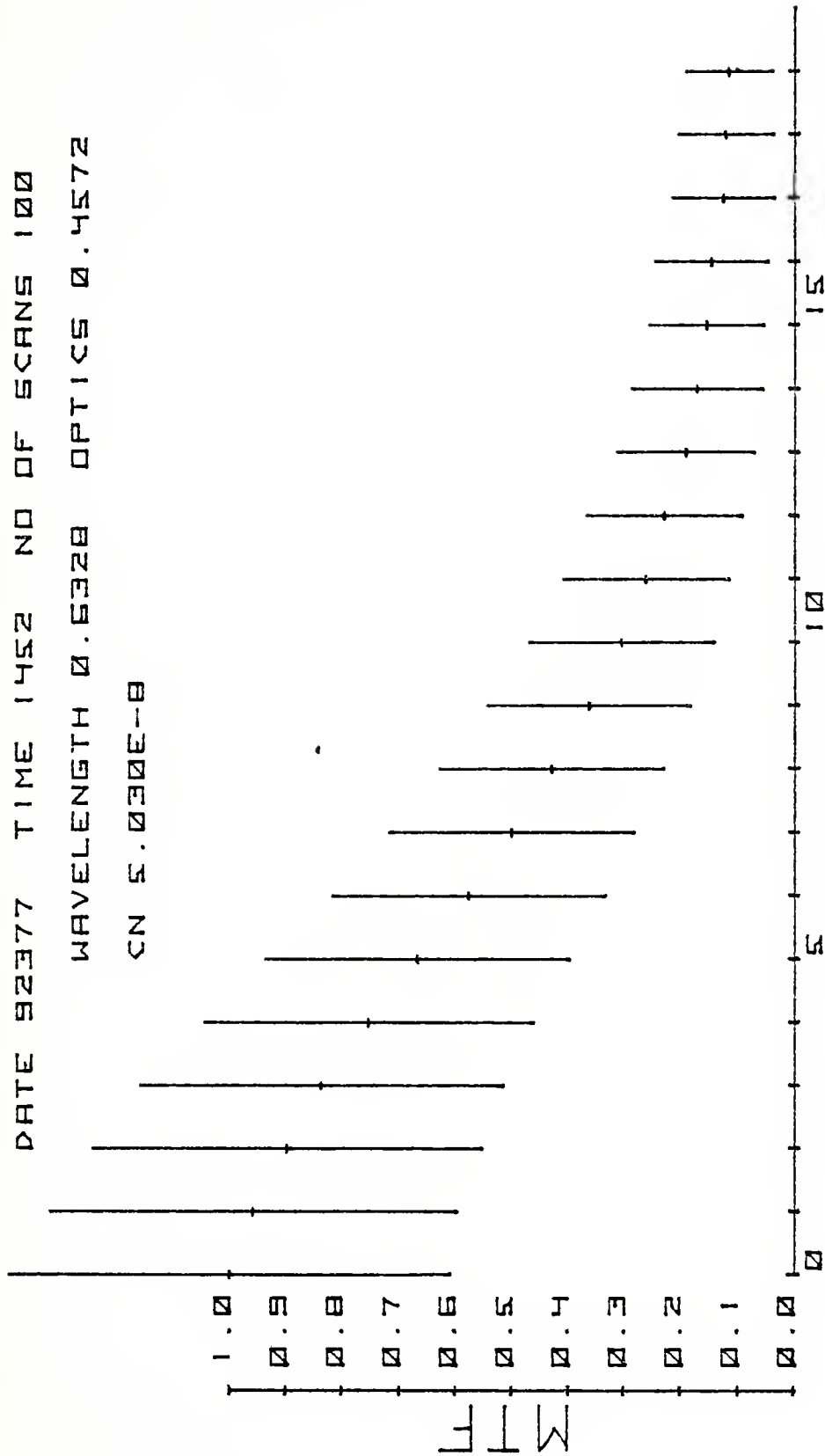

SPATIAL FREQUENCY IN 1 / MILLIRADIANS

DATA SUMMARY

DATE 21877 TIME 1103

Cn 5.620 E-8 OPTICS 0.4572

TEST DIST. NORMAL		TEST DIST LN NORMAL	
SPAT FR	MEAN	ST. DEV	CHI SQ
0	1.48272E-01	5.60926E-02	1.15417E 01
1	1.42776E-01	5.58007E-02	1.27061E 01
2	1.35619E-01	5.44013E-02	1.07756E 01
3	1.28437E-01	5.13296E-02	1.15240E 01
4	1.18567E-01	4.80628E-02	1.10963E 01
5	1.07869E-01	4.40233E-02	1.15435E 01
6	9.65753E-02	3.92243E-02	1.44630E 01
7	8.46952E-02	3.55537E-02	1.59943E 01
8	7.39577E-02	3.17559E-02	2.60970E 01
9	6.36111E-02	2.91988E-02	2.23805E 01
10	5.35449E-02	2.64905E-02	1.86492E 01
11	4.50812E-02	2.43676E-02	2.29186E 01
12	3.82541E-02	2.24112E-02	2.05158E 01
13	3.13950E-02	2.07374E-02	2.54298E 01
14	2.67143E-02	1.97336E-02	3.02457E 01
15	2.28878E-02	1.90357E-02	4.15237E 01
16	1.98107E-02	1.73904E-02	4.85976E 01
17	1.68588E-02	1.65041E-02	5.93177E 01
18	1.53430E-02	1.53733E-02	6.24878E 01
19	1.42986E-02	1.44734E-02	5.73674E 01
			9.34213E 00
			1.47177E 01
			1.14812E 01
			1.21130E 01
			1.08970E 01
			9.40901E 00
			1.20035E 01
			1.26207E 01
			1.47126E 01
			1.70406E 01
			1.83359E 01
			1.69649E 01
			2.04634E 01
			1.82638E 01
			2.61132E 01
			2.12804E 01
			1.83093E 01
			1.50298E 01
			1.16946E 01
			1.08431E 01

MTF MEAN AND \pm 1 STANDARD DEVIATION

DATE 21077 TIME 1103 NO OF SCANS 86

WAVELENGTH 0.6328 OPTICS 0.4572

CN 5.620E-8

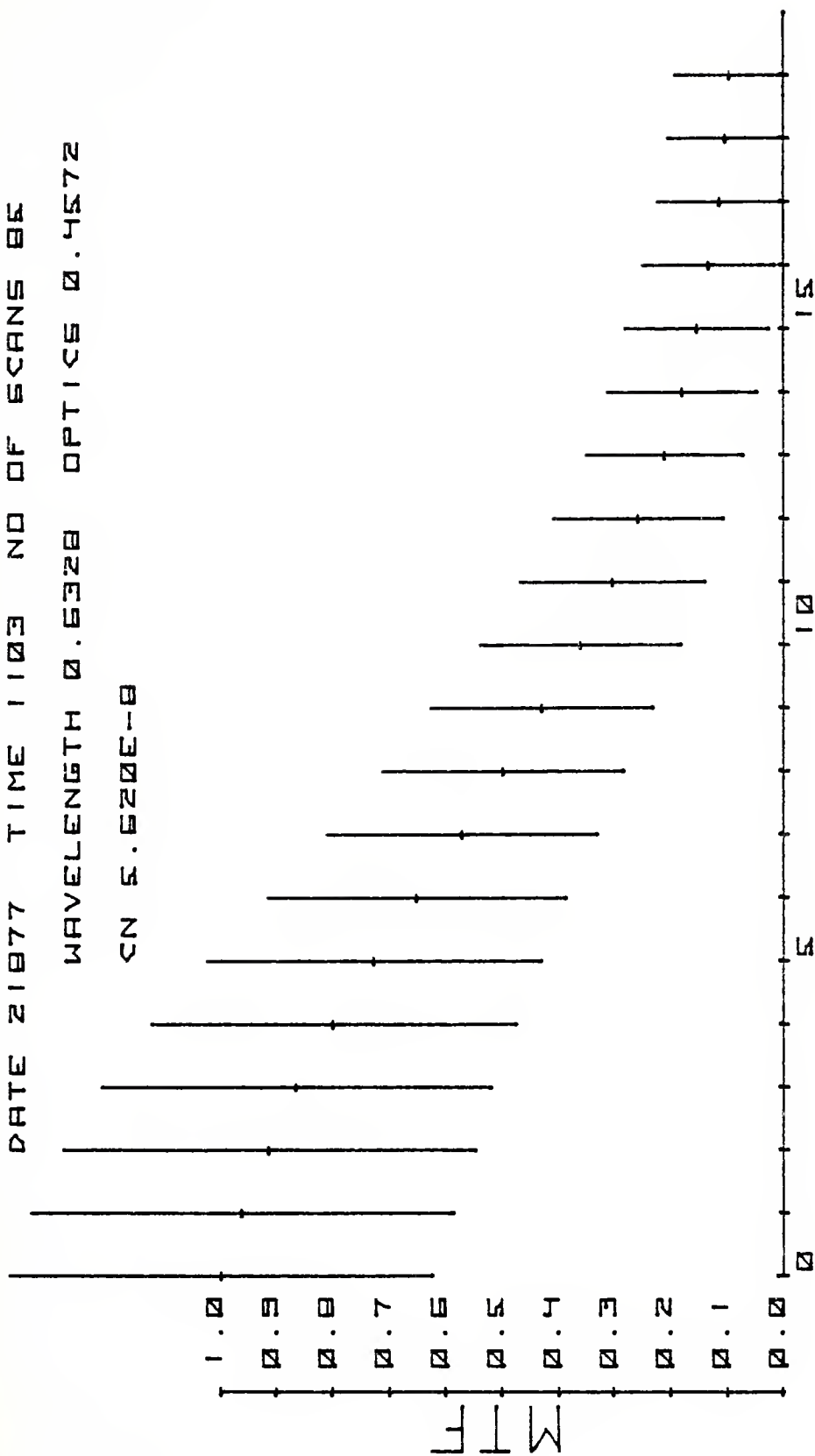

SPATIAL FREQUENCY IN 1 / MILLIRADIANS

DATA SUMMARY

DATE 121776 TIME 1244

Cn 5.860 E-8 OPTICS 0.4572

TEST DIST LN NORMAL

TEST DIST. NORMAL

SPAT FR	MEAN	ST. DEV	CHI SQ	CHI SQ
0	1.37317E-02	8.17843E-03	2.70350E 01	3.62417E 01
1	1.33957E-02	4.93997E-03	2.04201E 01	1.58942E 01
2	1.20970E-02	4.68488E-03	1.80754E 01	1.92147E 01
3	1.24253E-02	4.26531E-03	4.06258E 01	2.45009E 01
4	1.14186E-02	4.10517E-03	2.46701E 01	1.71996E 01
5	1.09627E-02	4.05317E-03	2.26556E 01	2.06507E 01
6	9.98504E-03	3.83191E-03	1.69257E 01	2.25648E 01
7	9.51552E-03	3.59380E-03	2.00590E 01	2.59550E 01
8	8.67328E-03	3.68454E-03	2.27673E 01	1.34494E 01
9	7.83145E-03	3.42657E-03	3.08982E 01	1.81884E 01
10	7.09925E-03	3.25645E-03	1.60637E 01	3.90257E 01
11	6.85188E-03	3.10059E-03	1.95198E 01	3.41090E 01
12	5.87715E-03	2.79726E-03	1.49487E 01	2.23208E 01
13	5.85905E-03	2.82733E-03	2.52537E 01	2.10238E 01
14	5.22471E-03	2.71907E-03	3.50412E 01	3.15065E 01
15	5.39555E-03	2.85837E-03	1.78221E 01	2.70895E 01
16	4.69350E-03	2.65742E-03	2.72693E 01	3.13269E 01
17	4.01533E-03	2.39457E-03	2.95787E 01	3.31843E 01
18	3.99261E-03	2.29407E-03	2.91754E 01	3.36513E 01
19	3.69197E-03	2.26312E-03	2.76450E 01	2.32799E 01

MTF MEAN AND ± 1 STANDARD DEVIATION
 DATE 121776 TIME 1244 NO OF SCANS 126
 WAVELENGTH 0.6328 OPTICS 0.4572

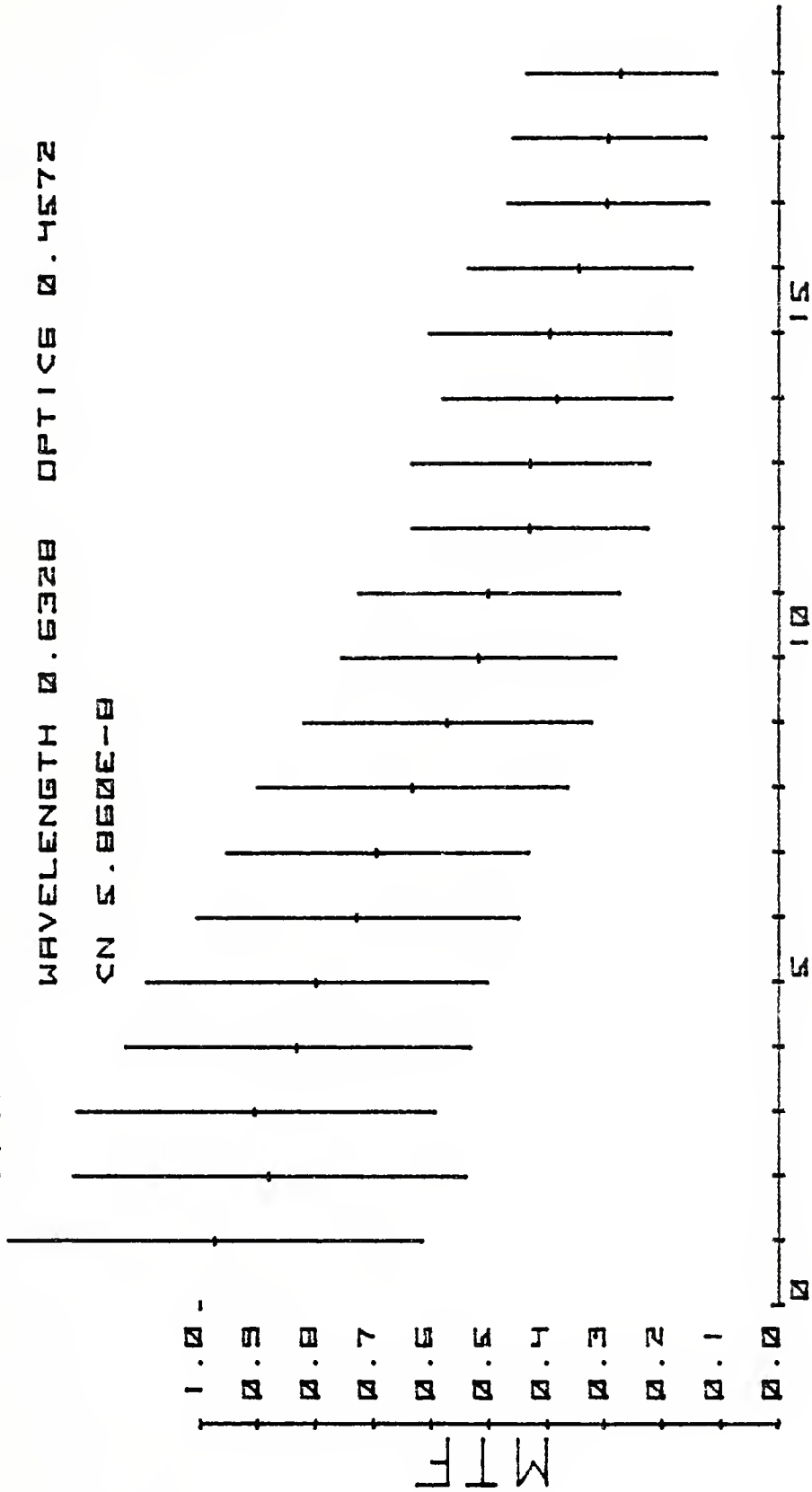

SPATIAL FREQUENCY IN 1 / MILLIRADIANS

DATA SUMMARY

DATE 92377 TIME 1522

Cn 5.890 E-8 OPTICS 0.4572

SPAT FR	TEST DIST. NORMAL		TEST DIST LN NORMAL	
	MEAN	ST. DEV	CHI SQ	CHI SQ
0	1.02607E-01	3.51003E-02	2.00921E 01	1.60845E 01
1	9.85698E-02	3.40048E-02	2.15239E 01	1.52371E 01
2	9.06474E-02	3.25416E-02	1.63889E 01	1.38473E 01
3	8.13128E-02	2.93312E-02	1.67973E 01	2.30608E 01
4	7.01266E-02	2.67650E-02	2.03266E 01	1.55228E 01
5	5.93895E-02	2.38878E-02	2.00582E 01	2.06738E 01
6	4.87438E-02	2.13347E-02	2.42156E 01	1.49832E 01
7	4.04951E-02	1.86820E-02	2.22186E 01	1.76575E 01
8	3.26599E-02	1.66191E-02	1.81657E 01	1.64375E 01
9	2.65375E-02	1.48670E-02	2.82308E 01	1.13632E 01
10	2.09897E-02	1.26819E-02	2.80543E 01	2.23802E 01
11	1.74709E-02	1.13616E-02	3.76901E 01	2.95427E 01
12	1.44604E-02	9.66286E-03	2.56870E 01	2.32332E 01
13	1.25203E-02	8.47483E-03	3.86797E 01	1.93346E 01
14	1.12000E-02	7.31785E-03	2.53380E 01	2.16755E 01
15	1.04037E-02	6.83282E-03	3.10317E 01	1.77729E 01
16	9.39873E-03	6.37123E-03	4.01756E 01	1.56518E 01
17	8.52202E-03	5.62062E-03	3.59733E 01	2.60696E 01
18	8.44130E-03	5.11001E-03	2.38370E 01	2.28494E 01
19	8.57002E-03	5.08650E-03	3.57444E 01	2.65074E 01

DATA SUMMARY

DATE 92377 TIME 1522

Cn 5.980 E-8 OPTICS 0.4572

TEST DIST LN NORMAL

TEST DIST. NORMAL

SPAT FR	MEAN	ST. DEV	CHI SQ	CHI SQ
0	1.09502E-01	5.91930E-02	3.69616E 01	1.45251E 01
1	1.01388E-01	3.83632E-02	2.39938E 01	1.26590E 01
2	9.28172E-02	3.63813E-02	2.65852E 01	1.61914E 01
3	8.42185E-02	3.31347E-02	2.18294E 01	1.37473E 01
4	7.17480E-02	2.97731E-02	2.32123E 01	1.98946E 01
5	6.15126E-02	2.60089E-02	2.24781E 01	1.52240E 01
6	5.05769E-02	2.29365E-02	2.52199E 01	1.12153E 01
7	4.23362E-02	1.99726E-02	1.75567E 01	1.56622E 01
8	3.40682E-02	1.70108E-02	2.11803E 01	1.34414E 01
9	2.78922E-02	1.50542E-02	2.32255E 01	1.52412E 01
10	2.21463E-02	1.27265E-02	3.52668E 01	2.08920E 01
11	1.92532E-02	1.15057E-02	2.28908E 01	2.80259E 01
12	1.57461E-02	9.78852E-03	2.74275E 01	2.09415E 01
13	1.37113E-02	9.10941E-03	3.35202E 01	2.65844E 01
14	1.21512E-02	8.36553E-03	3.45634E 01	1.57212E 01
15	1.09998E-02	8.32333E-03	4.80926E 01	1.99339E 01
16	1.04551E-02	7.35230E-03	4.13738E 01	2.16484E 01
17	9.73994E-03	7.18733E-03	3.97675E 01	2.15235E 01
18	9.34131E-03	7.25779E-03	4.81360E 01	3.07690E 01
19	8.61028E-03	6.96394E-03	4.41832E 01	1.85467E 01

DATA SUMMARY

DATE 92377 TIME 1522
 Cn 5.980 E-8 OPTICS 0.4572

TEST DIST LN NORMAL

TEST DIST. NORMAL

SPAT FR	MEAN	ST. DEV	CHI SQ	CHI SQ	TEST DIST LN NORMAL
0	9.85814E-02	3.36811E-02	2.73863E 01	2.80077E 01	
1	9.38412E-02	3.23169E-02	3.46296E 01	2.25390E 01	
2	8.60977E-02	3.02486E-02	2.47768E 01	1.27898E 01	
3	7.73232E-02	2.73176E-02	2.22419E 01	1.16007E 01	
4	6.62252E-02	2.43302E-02	2.88328E 01	1.04258E 01	
5	5.63719E-02	2.18271E-02	3.26490E 01	1.83682E 01	
6	4.63099E-02	1.89172E-02	2.18806E 01	1.48737E 01	
7	3.85208E-02	1.68633E-02	2.48103E 01	1.76737E 01	
8	3.06189E-02	1.45536E-02	4.29586E 01	1.52017E 01	
9	2.51104E-02	1.28870E-02	2.82554E 01	1.96199E 01	
10	1.97765E-02	1.13313E-02	3.58993E 01	2.25963E 01	
11	1.62370E-02	9.71632E-03	4.05640E 01	1.44577E 01	
12	1.37723E-02	8.73031E-03	4.06393E 01	1.39955E 01	
13	1.16134E-02	8.03626E-03	3.58171E 01	2.12504E 01	
14	1.05476E-02	6.98244E-03	4.47934E 01	1.88393E 01	
15	9.35828E-03	6.49720E-03	3.63284E 01	1.61714E 01	
16	8.48068E-03	5.81969E-03	4.15810E 01	2.87703E 01	
17	7.97576E-03	5.65067E-03	3.20487E 01	2.98800E 01	
18	7.69533E-03	5.14433E-03	3.14189E 01	4.70130E 01	
19	7.75169E-03	5.01998E-03	4.22816E 01	2.69716E 01	

DATA SUMMARY

DATE 92377 TIME 1522

Cn 5.980 E-8 OPTICS 0.4572

SPAT FR	TEST DIST. NORMAL			TEST DIST LN NORMAL		
	MEAN	ST. DEV	CHI SQ	CHI SQ	DIST LN	CHI SQ
0	1.13698E-01	9.76655E-02	1.00253E 02	1.71887E 01		
1	1.01726E-01	3.86131E-02	2.63609E 01	1.35814E 01		
2	9.25535E-02	3.68663E-02	2.74833E 01	1.16392E 01		
3	8.44121E-02	3.35456E-02	2.38512E 01	1.44909E 01		
4	7.15969E-02	2.99576E-02	2.19483E 01	1.30883E 01		
5	6.18214E-02	2.64480E-02	2.50240E 01	1.66187E 01		
6	5.06947E-02	2.29144E-02	2.88596E 01	1.07229E 01		
7	4.26873E-02	2.07001E-02	2.58249E 01	2.03723E 01		
8	3.44150E-02	1.69633E-02	2.28067E 01	1.60961E 01		
9	2.82226E-02	1.61764E-02	2.71099E 01	1.39514E 01		
10	2.25461E-02	1.30326E-02	2.29307E 01	1.55419E 01		
11	1.95944E-02	1.29869E-02	2.68111E 01	2.03357E 01		
12	1.59194E-02	1.07353E-02	2.95640E 01	1.47709E 01		
13	1.41643E-02	1.10009E-02	4.14056E 01	2.87645E 01		
14	1.24035E-02	9.80672E-03	3.31727E 01	2.81462E 01		
15	1.14200E-02	1.03373E-02	5.81029E 01	2.12278E 01		
16	1.08559E-02	9.22027E-03	6.12906E 01	2.45357E 01		
17	1.01094E-02	9.47715E-03	4.69776E 01	1.91371E 01		
18	9.73728E-03	9.26478E-03	7.27727E 01	3.53394E 01		
19	9.08653E-03	9.67947E-03	6.85725E 01	1.56391E 01		

DATA SUMMARY

DATE 92377 TIME 1522

Cn 5.980 E-8 OPTICS 0.4572

TEST DIST. NORMAL			TEST DIST LN NORMAL		
SPAT FR	MEAN	ST. DEV.	CHI SQ	CHI SQ	CHI SQ
0	9.76719E-02	3.39885E-02	2.72768E 01	2.72768E 01	1.93388E 01
1	9.22566E-02	3.21452E-02	3.31962E 01	3.31962E 01	1.38076E 01
2	8.46623E-02	3.04848E-02	2.59631E 01	2.59631E 01	1.35641E 01
3	7.60379E-02	2.72228E-02	2.56735E 01	2.56735E 01	1.15653E 01
4	6.53139E-02	2.43095E-02	2.87869E 01	2.87869E 01	1.14680E 01
5	5.57862E-02	2.17337E-02	3.19461E 01	3.19461E 01	1.29100E 01
6	4.58114E-02	1.88013E-02	2.35814E 01	2.35814E 01	9.51535E 00
7	3.83336E-02	1.67080E-02	4.02596E 01	4.02596E 01	1.71107E 01
8	3.03276E-02	1.44224E-02	4.57099E 01	4.57099E 01	1.40219E 01
9	2.50848E-02	1.27280E-02	3.09175E 01	3.09175E 01	1.79529E 01
10	1.98037E-02	1.12041E-02	3.26048E 01	3.26048E 01	2.09033E 01
11	1.63198E-02	9.59726E-03	3.35089E 01	3.35089E 01	1.44928E 01
12	1.36400E-02	8.71507E-03	3.65125E 01	3.65125E 01	2.30197E 01
13	1.17367E-02	7.86141E-03	3.81222E 01	3.81222E 01	2.28711E 01
14	1.07680E-02	7.16657E-03	2.29131E 01	2.29131E 01	2.35590E 01
15	9.91479E-03	6.21625E-03	3.15318E 01	3.15318E 01	2.66697E 01
16	8.53110E-03	5.70390E-03	2.97678E 01	2.97678E 01	3.33227E 01
17	8.20299E-03	5.55707E-03	4.81652E 01	4.81652E 01	1.69599E 01
18	7.75283E-03	5.11945E-03	2.27208E 01	2.27208E 01	2.42623E 01
19	7.65018E-03	4.91070E-03	3.37550E 01	3.37550E 01	2.89889E 01

MTF MEAN AND ± 1 STANDARD DEVIATION
 DATE 92377 TIME 1522 NO OF SCANS 100
 WAVELENGTH 0.6328 OPTICS 0.4572
 CN 5.880E-8

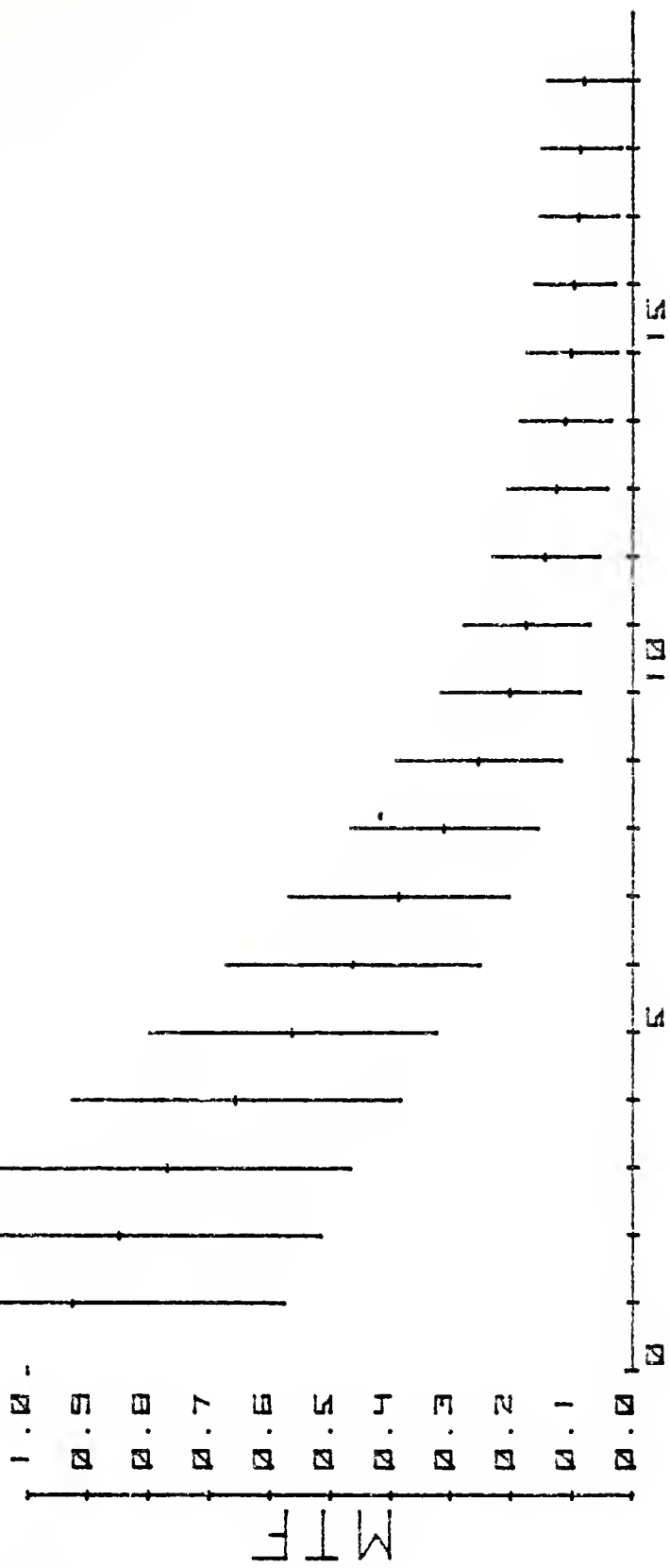

SPATIAL FREQUENCY IN 1 / MILLIRADIANS

MTF MEAN AND \pm 1 STANDARD DEVIATION
 DATE 92377 TIME 1522 NO OF SCANS 100
 WAVELENGTH 0.6328 OPTICS 0.4572
 CN 5.980E-8

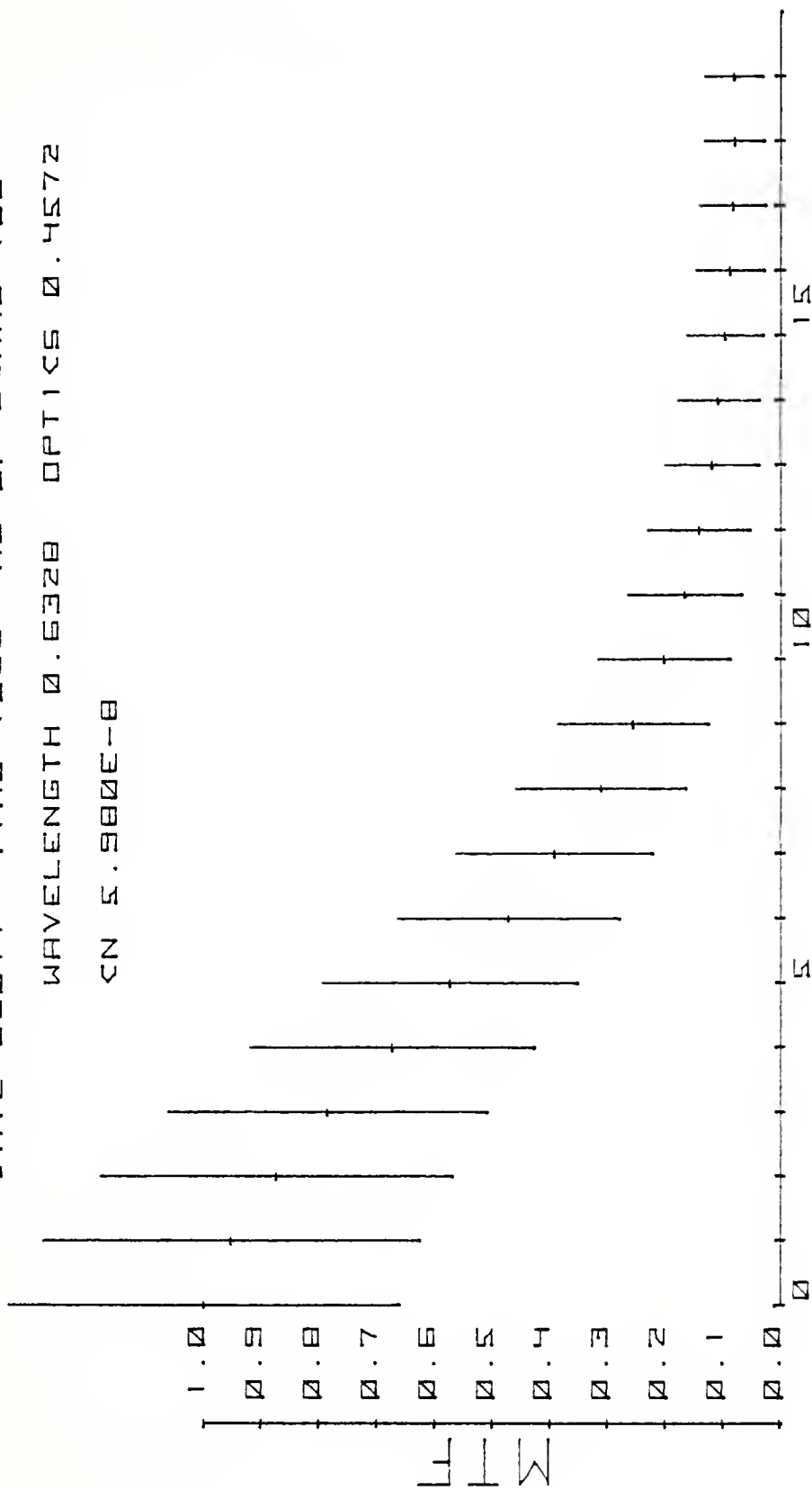

SPATIAL FREQUENCY IN 1 / MILLIRADIANS

MTF MEAN AND ± 1 STANDARD DEVIATION
 DATE 92377 TIME 1522 NO OF SCANS 100
 WAVELENGTH 0.6328 OPTICS 0.4572
 CN 5.890E-0

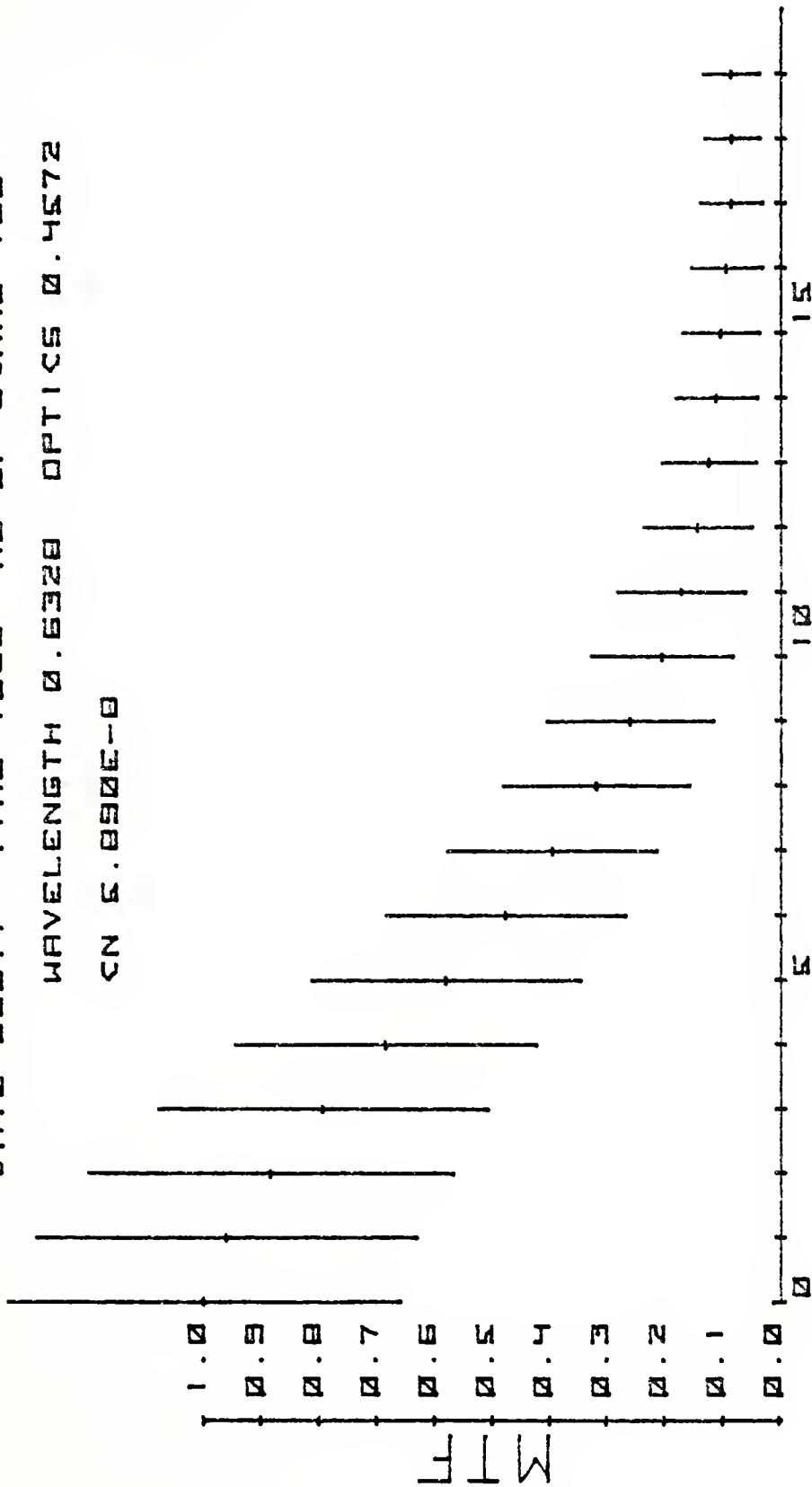

SPATIAL FREQUENCY IN 1 / MILLIRADIANS

MTF MEAN AND ± 1 STANDARD DEVIATION
 DATE 92377 TIME 1522 NO OF SCANS 100
 WAVELENGTH 0.6328 OPTICS 0.4572
 CN 5.980E-8

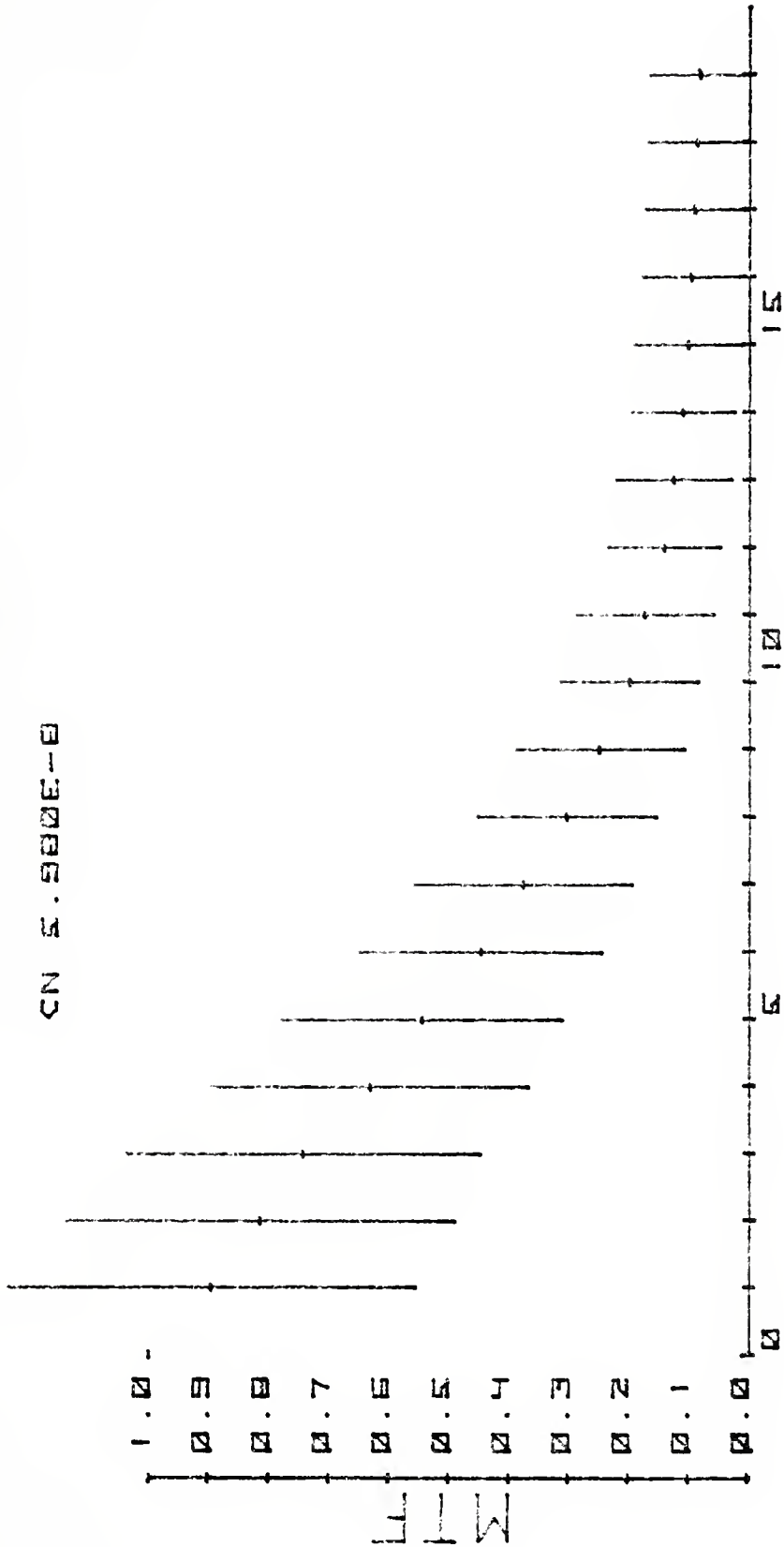

SPATIAL FREQUENCY IN 1 / MILLIRADIANS

MTF MEAN AND ± 1 STANDARD DEVIATION
 DATE 92377 TIME 1522 NO OF SCANS 100
 WAVELENGTH 0.6328 OPTICS 0.4572
 CN 5.980E-8

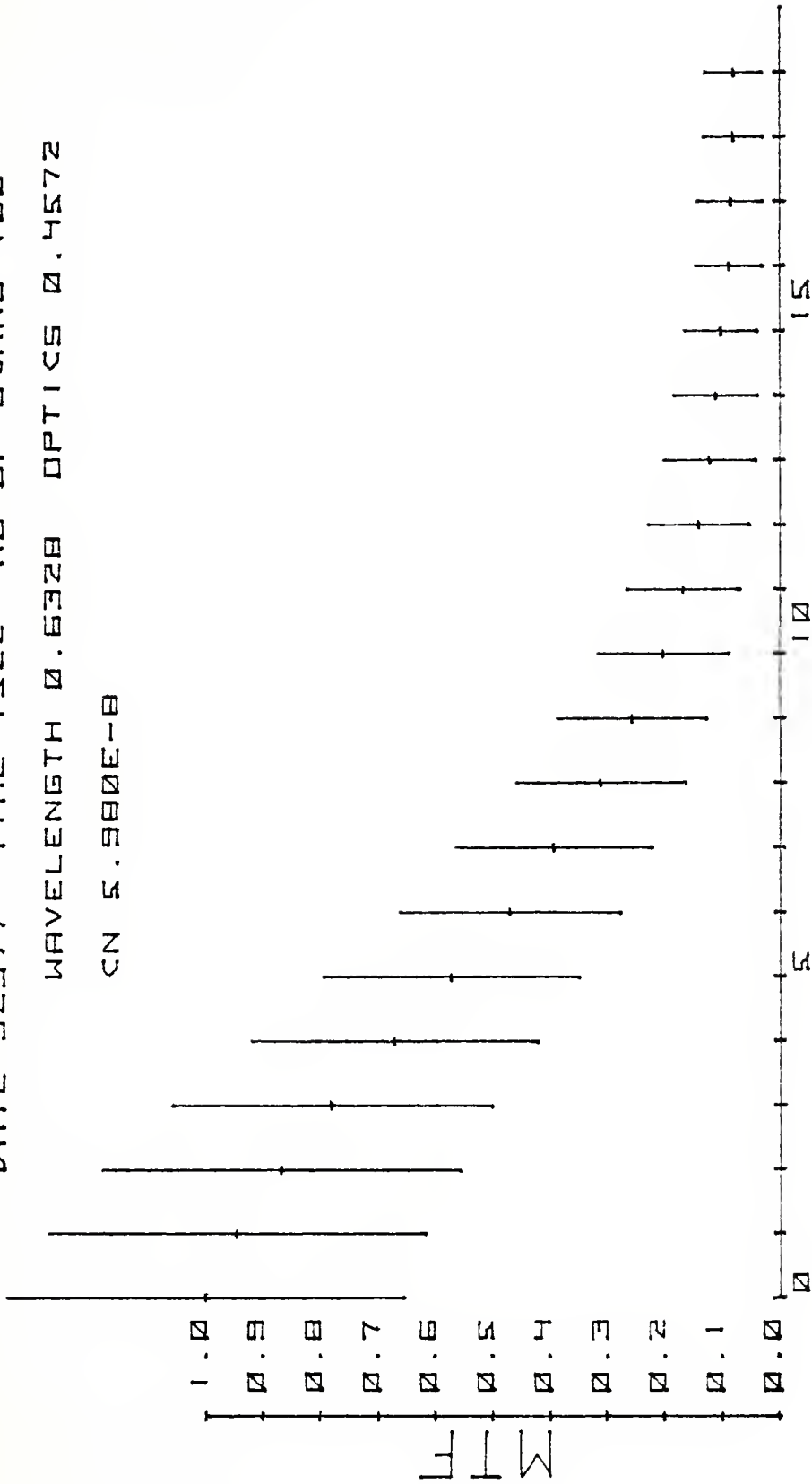

SPATIAL FREQUENCY IN 1 / MILLIRADIANS

DATA SUMMARY

DATE 92277 TIME 1616

Cn 5.940 E-8 OPTICS 0.4572

TEST DIST. NORMAL			TEST DIST LN NORMAL		
SPAT FR	MEAN	ST. DEV	CHI SQ	CHI SQ	
0	1.01908E-01	4.06907E-02	1.53986E 01	3.01399E 01	
1	9.55118E-02	3.51973E-02	2.56864E 01	2.42798E 01	
2	8.65733E-02	3.39558E-02	2.68801E 01	2.51941E 01	
3	7.99775E-02	2.98301E-02	2.26617E 01	2.71587E 01	
4	6.79418E-02	2.74456E-02	1.96562E 01	1.23271E 01	
5	5.70203E-02	2.48530E-02	2.55837E 01	1.76901E 01	
6	4.68984E-02	2.24589E-02	4.06269E 01	1.87669E 01	
7	3.91011E-02	1.78409E-02	3.41532E 01	1.67304E 01	
8	3.11868E-02	1.68769E-02	5.18359E 01	1.97024E 01	
9	2.54100E-02	1.43172E-02	3.89268E 01	3.06111E 01	
10	2.03644E-02	1.26904E-02	3.97709E 01	2.00195E 01	
11	1.61240E-02	9.91428E-03	3.02382E 01	2.46973E 01	
12	1.40871E-02	9.10950E-03	2.93426E 01	3.18054E 01	
13	1.28644E-02	7.64894E-03	5.60545E 01	2.24498E 01	
14	1.21700E-02	7.12839E-03	2.26968E 01	2.28553E 01	
15	1.13834E-02	6.58600E-03	2.49763E 01	1.68088E 01	
16	1.11869E-02	6.89215E-03	2.73593E 01	3.43056E 01	
17	1.06509E-02	5.66981E-03	1.85875E 01	3.40131E 01	
18	1.04253E-02	6.27622E-03	3.11051E 01	1.87098E 01	
19	1.11974E-02	6.83892E-03	2.43346E 01	4.35534E 01	

MTF MEAN AND ± 1 STANDARD DEVIATION

DATE 92277 TIME 1616 NO. OF SCANS 110

WAVELENGTH 0.6328 OPTICS 0.4572

CN 5.940E-8

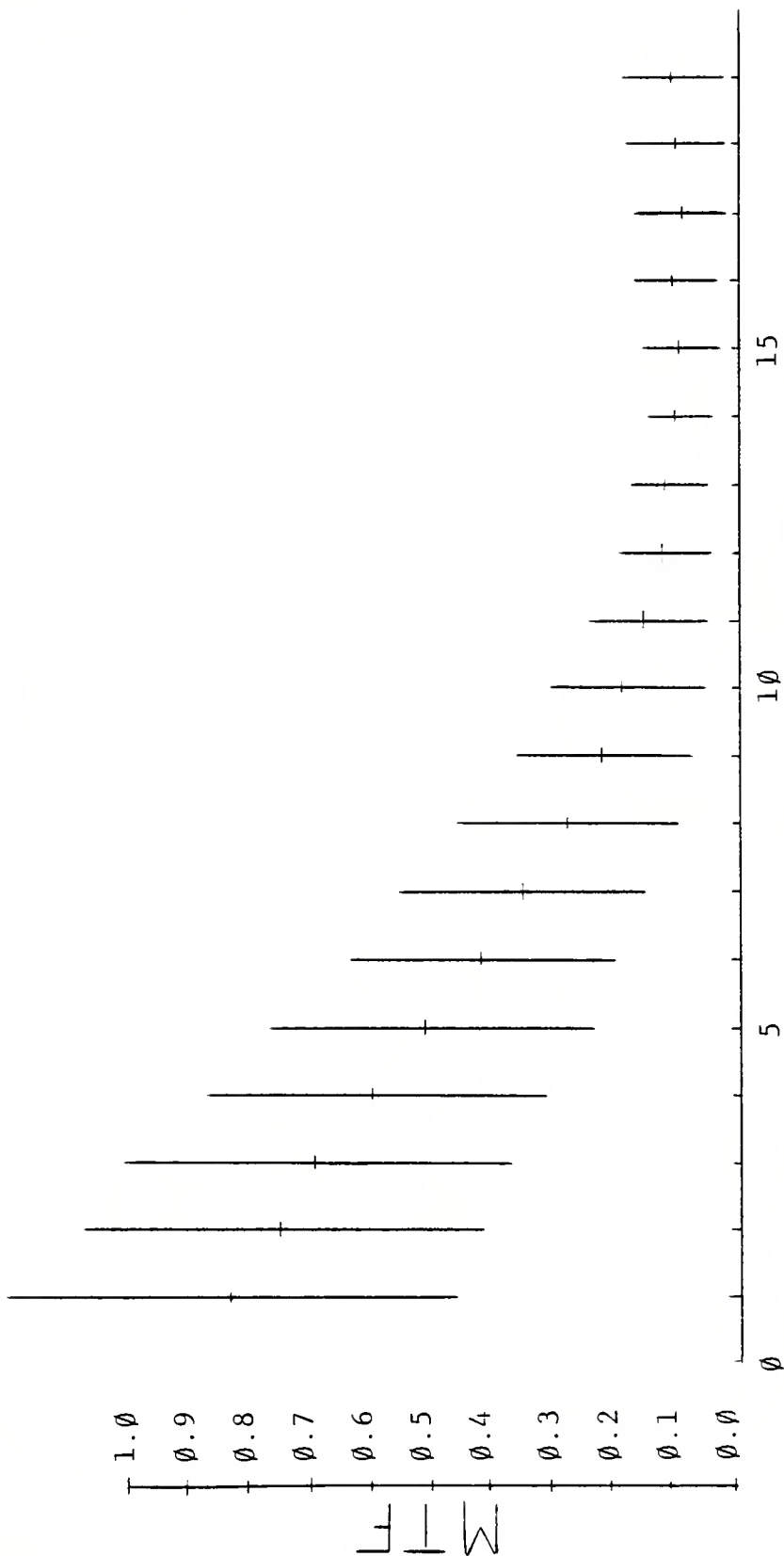

SPATIAL FREQUENCY IN 1/ MILLIRADIANS

DATA SUMMARY

DATE 92277 TIME 1705

Cn 6.080 E-8 OPTICS 0.4572

TEST DIST. NORMAL			TEST DIST LN NORMAL		
SPAT FR	MEAN	ST. DEV	CHI SQ	CHI SQ	CHI SQ
0	7.73555E-02	3.06269E-02	2.03006E 01	8.86336E 00	
1	7.71243E-02	2.65214E-02	1.97674E 01	1.18669E 01	
2	7.33262E-02	2.47494E-02	1.69761E 01	1.29185E 01	
3	6.96548E-02	2.36600E-02	2.31530E 01	1.63698E 01	
4	6.39281E-02	2.19530E-02	2.24162E 01	5.55663E 00	
5	5.81557E-02	1.98889E-02	1.92760E 01	9.26315E 00	
6	5.14453E-02	1.81617E-02	1.88720E 01	9.77051E 00	
7	4.48906E-02	1.58665E-02	1.73181E 01	1.60113E 01	
8	3.94524E-02	1.48045E-02	1.33061E 01	1.50515E 01	
9	3.46425E-02	1.29324E-02	1.87895E 01	2.08207E 01	
10	2.91989E-02	1.21186E-02	1.54501E 01	2.62754E 01	
11	2.49115E-02	9.62966E-03	8.40366E 00	1.56036E 01	
12	2.09025E-02	8.66648E-03	2.13360E 01	2.23773E 01	
13	1.80762E-02	8.40333E-03	1.63266E 01	2.17000E 01	
14	1.51682E-02	7.88689E-03	2.83601E 01	1.53699E 01	
15	1.30429E-02	6.48437E-03	1.73002E 01	2.25887E 01	
16	1.18019E-02	6.09067E-03	1.93656E 01	2.71659E 01	
17	1.05102E-02	5.86080E-03	1.70946E 01	2.49083E 01	
18	8.95734E-03	4.74009E-03	1.98250E 01	2.49879E 01	
19	7.91184E-03	4.26676E-03	1.64076E 01	1.68219E 01	

MTF MEAN AND ± 1 STANDARD DEVIATION

DATE 92277 TIME 1705 NO OF SCANS 75

WAVELENGTH 0.6328 OPTICS 0.4572

CN 6.000E-8

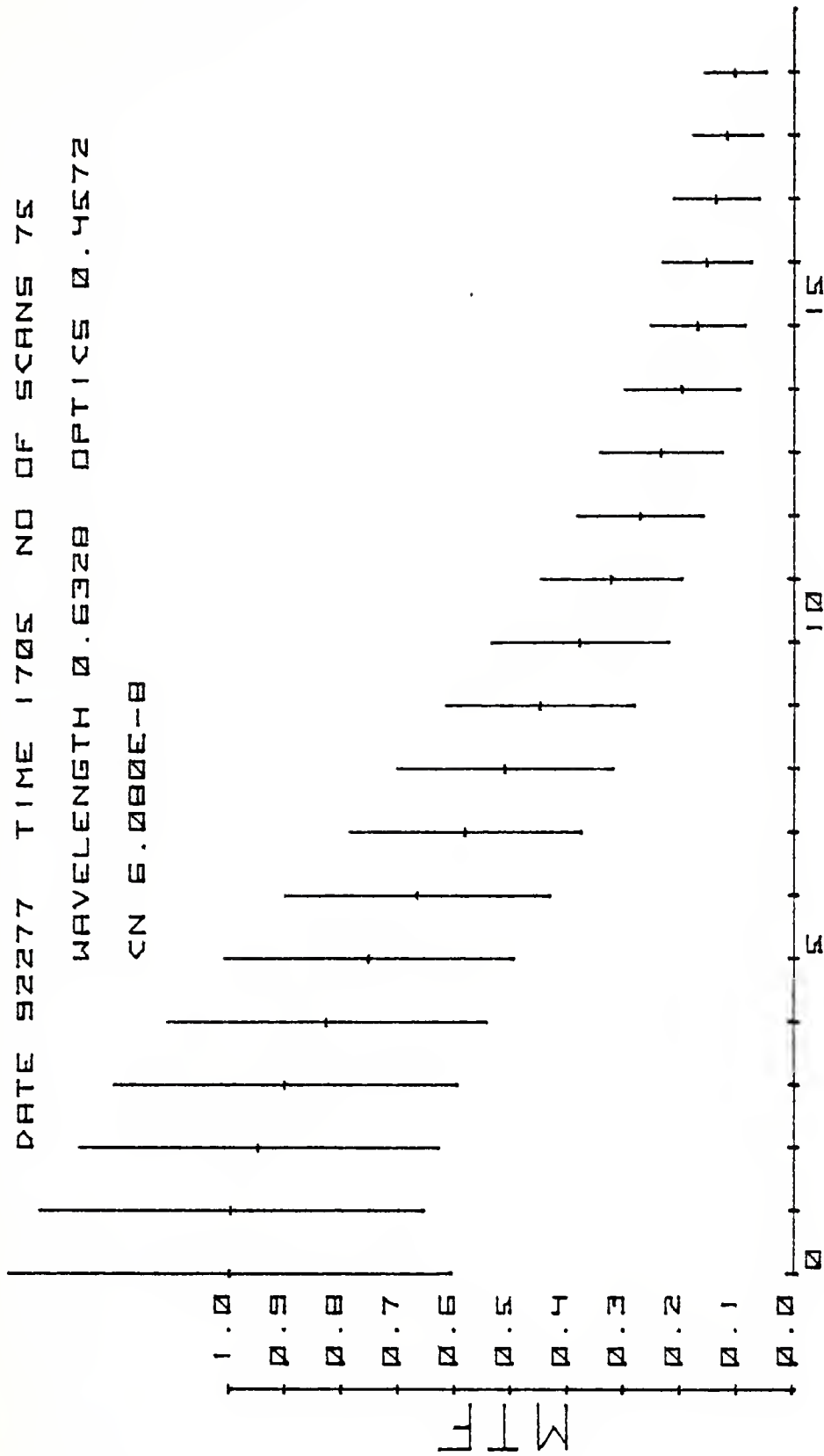

SPATIAL FREQUENCY IN 1 / MILLIRADIANS

DATA SUMMARY

DATE 121776 TIME 1012

Cn 6.920 E-8 OPTICS 0.4572

TEST DIST. NORMAL		TEST DIST LN NORMAL	
SPAT FR	MEAN	ST. DEV	CHI SQ
0	7.49522E-02	3.50393E-02	1.83287E 01
1	7.14103E-02	3.41578E-02	2.01151E 01
2	6.67162E-02	3.31582E-02	1.75331E 01
3	6.21510E-02	3.02999E-02	1.72078E 01
4	5.47640E-02	2.67957E-02	1.61330E 01
5	4.77540E-02	2.33212E-02	1.69282E 01
6	3.92084E-02	1.93493E-02	1.50800E 01
7	3.21644E-02	1.61678E-02	1.95963E 01
8	2.55655E-02	1.36096E-02	2.83616E 01
9	2.02033E-02	1.14392E-02	2.61104E 01
10	1.53582E-02	9.77763E-03	2.75968E 01
11	1.28230E-02	8.34145E-03	3.30171E 01
12	1.00444E-02	7.77741E-03	4.34068E 01
13	9.34077E-03	7.07480E-03	4.67267E 01
14	8.17720E-03	6.23522E-03	3.59898E 01
15	7.89431E-03	6.28802E-03	4.32475E 01
16	6.32378E-03	5.45431E-03	3.91986E 01
17	6.37718E-03	5.47009E-03	3.06438E 01
18	5.18286E-03	4.17330E-03	3.78582E 01
19	5.54834E-03	4.45966E-03	3.05167E 01
			1.81959E 01
			2.14334E 01
			1.27114E 01
			1.09852E 01
			1.06685E 01
			1.92024E 01
			2.41451E 01
			1.46662E 01
			1.61656E 01
			1.83619E 01
			1.21523E 01
			1.14853E 01
			1.35630E 01
			1.95647E 01
			7.21945E 00
			1.98422E 01
			1.84136E 01
			1.99191E 01
			2.23769E 01
			1.50580E 01

MTF MEAN AND \pm 1 STANDARD DEVIATION
 DATE 121776 TIME 1012 NO OF SCANS 70
 WAVELENGTH 0.6328 OPTICS 0.4572
 CN 6.920E-8

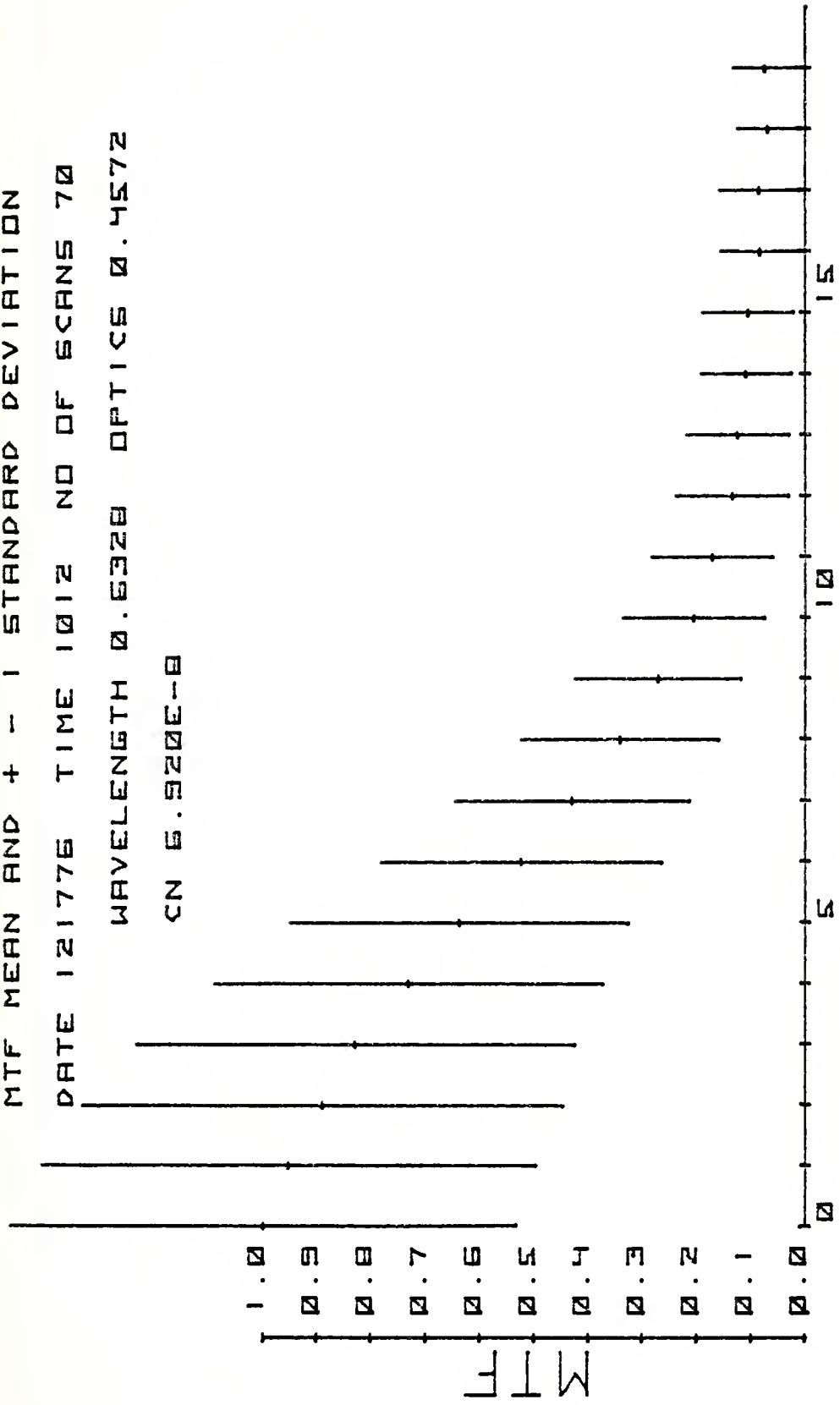

SPATIAL FREQUENCY IN 1 / MILLIRADIANS

DATA SUMMARY

DATE 21577 TIME 1700

Cn 6.990 E-8 OPTICS 0.4572

SPAT FR	MEAN	ST. DEV	TEST DIST. NORMAL		TEST DIST LN NORMAL	
			CHI SQ	CHI SQ	CHI SQ	CHI SQ
0	4.56061E-02	2.79905E-02	3.79343E 01	3.79343E 01	7.44146E 01	7.44146E 01
1	5.13172E-02	1.16908E-02	2.50247E 01	2.50247E 01	1.04995E 02	1.04995E 02
2	5.00140E-02	1.14505E-02	1.95781E 01	1.95781E 01	9.34743E 01	9.34743E 01
3	3.96764E-02	1.15808E-02	1.42322E 01	1.42322E 01	1.05958E 02	1.05958E 02
4	4.00189E-02	1.00536E-02	2.33184E 01	2.33184E 01	7.37483E 01	7.37483E 01
5	2.70172E-02	9.42390E-03	1.81026E 01	1.81026E 01	1.69887E 01	1.69887E 01
6	2.25892E-02	9.08738E-03	2.55140E 01	2.55140E 01	5.80913E 01	5.80913E 01
7	2.50514E-02	9.47391E-03	9.88894E 00	9.88894E 00	3.26887E 01	3.26887E 01
8	1.91383E-02	9.21049E-03	1.33778E 01	1.33778E 01	4.97546E 01	4.97546E 01
9	1.72656E-02	7.96489E-03	1.33810E 01	1.33810E 01	3.55982E 01	3.55982E 01
10	1.53804E-02	7.29783E-03	1.49585E 01	1.49585E 01	2.65033E 01	2.65033E 01
11	1.38168E-02	7.91127E-03	3.13300E 01	3.13300E 01	1.19645E 01	1.19645E 01
12	1.34434E-02	7.76318E-03	4.83767E 01	4.83767E 01	3.19601E 01	3.19601E 01
13	1.24135E-02	5.66753E-03	1.62414E 01	1.62414E 01	2.90480E 01	2.90480E 01
14	1.11413E-02	5.93318E-03	2.17856E 01	2.17856E 01	2.48720E 01	2.48720E 01
15	1.21415E-02	5.71052E-03	1.90129E 01	1.90129E 01	2.71351E 01	2.71351E 01
16	1.11442E-02	5.54476E-03	2.02000E 01	2.02000E 01	1.44331E 01	1.44331E 01
17	1.20819E-02	6.27385E-03	1.82457E 01	1.82457E 01	1.93302E 01	1.93302E 01
18	1.26484E-02	6.06664E-03	1.95021E 01	1.95021E 01	2.25707E 01	2.25707E 01
19	1.13899E-02	6.15338E-03	1.92388E 01	1.92388E 01	2.37163E 01	2.37163E 01

MTF MEAN AND \pm 1 STANDARD DEVIATION

DATE 21577 TIME 1700 NO OF SCANS 115

WAVELENGTH 0.6328 OPTICS 0.4572

CN 6.930E-8

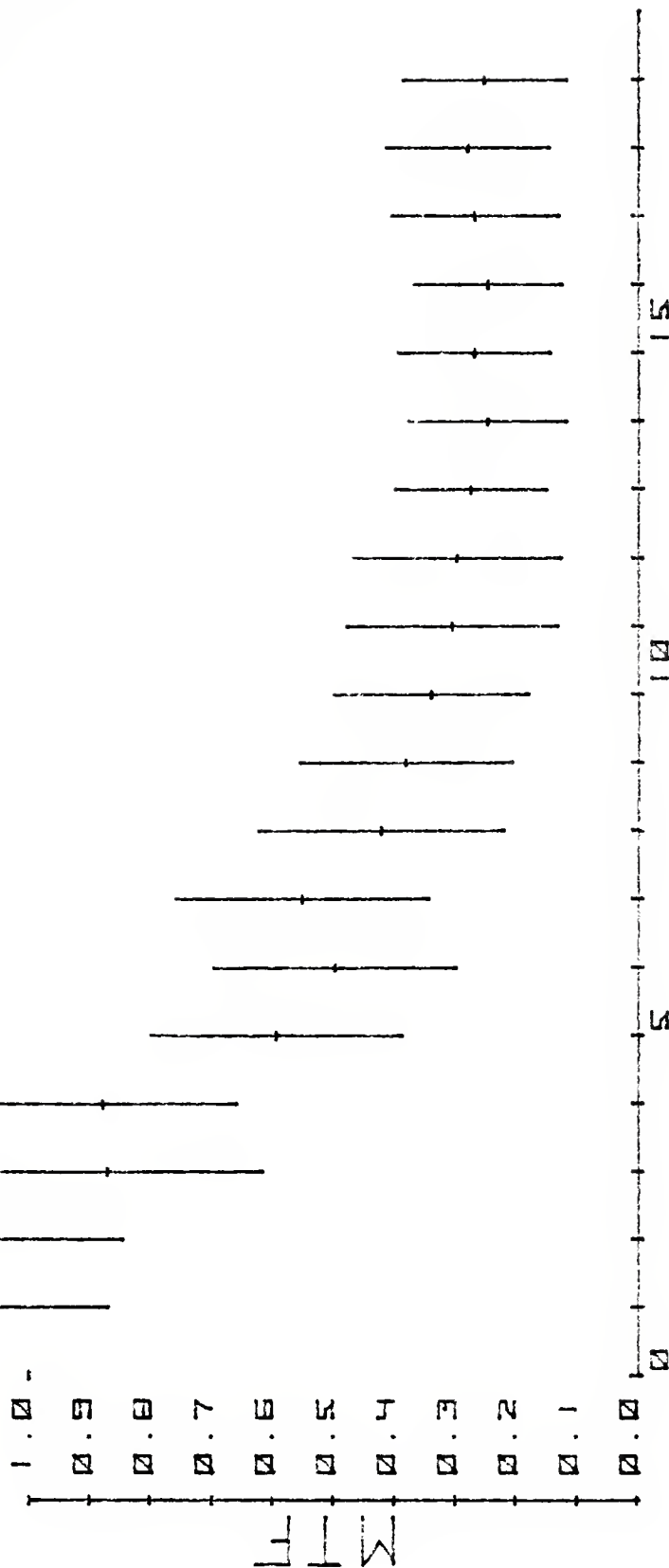

SPATIAL FREQUENCY IN 1 / MILLIRADIANS

DATA SUMMARY

DATE 21777 TIME 1900

Cn 7.280 E-8 OPTICS 0.4572

SPAT FR	TEST DIST. NORMAL		TEST DIST LN NORMAL	
	MEAN	ST. DEV	CHI SQ	CHI SQ
0	1.12087E-01	2.90336E-02	1.55726E 01	1.32494E 01
1	1.08720E-01	2.57492E-02	1.52158E 01	8.70205E 00
2	1.01337E-01	2.54003E-02	2.13801E 01	1.36482E 01
3	9.20540E-02	2.31998E-02	1.79617E 01	1.39559E 01
4	8.08589E-02	2.08901E-02	1.84141E 01	1.33010E 01
5	6.92183E-02	1.93240E-02	1.52475E 01	1.83936E 01
6	5.80394E-02	1.79871E-02	1.91107E 01	1.74259E 01
7	4.81500E-02	1.61913E-02	1.88746E 01	3.58393E 01
8	3.89659E-02	1.49251E-02	2.31122E 01	4.37837E 01
9	3.18186E-02	1.37772E-02	3.88483E 01	3.83230E 01
10	2.55147E-02	1.14386E-02	3.47288E 01	1.94061E 01
11	2.13289E-02	1.10267E-02	4.54710E 01	3.02554E 01
12	1.76893E-02	9.50219E-03	2.29173E 01	1.55668E 01
13	1.44811E-02	8.15713E-03	2.76356E 01	1.59845E 01
14	1.18693E-02	7.17253E-03	1.59949E 01	2.23498E 01
15	1.05332E-02	5.92825E-03	3.08462E 01	1.86106E 01
16	9.41762E-03	5.82602E-03	2.53399E 01	3.49478E 01
17	8.46276E-03	5.51299E-03	2.60849E 01	1.38865E 01
18	8.17001E-03	5.00056E-03	3.84344E 01	1.36105E 01
19	7.65048E-03	4.90834E-03	3.29719E 01	1.83247E 01

MTF MEAN AND \pm 1 STANDARD DEVIATION
 DATE 21777 TIME 1900 NO OF SCANS 90
 WAVELENGTH 0.6328 OPTICS 0.4572
 CN 7.200E-8

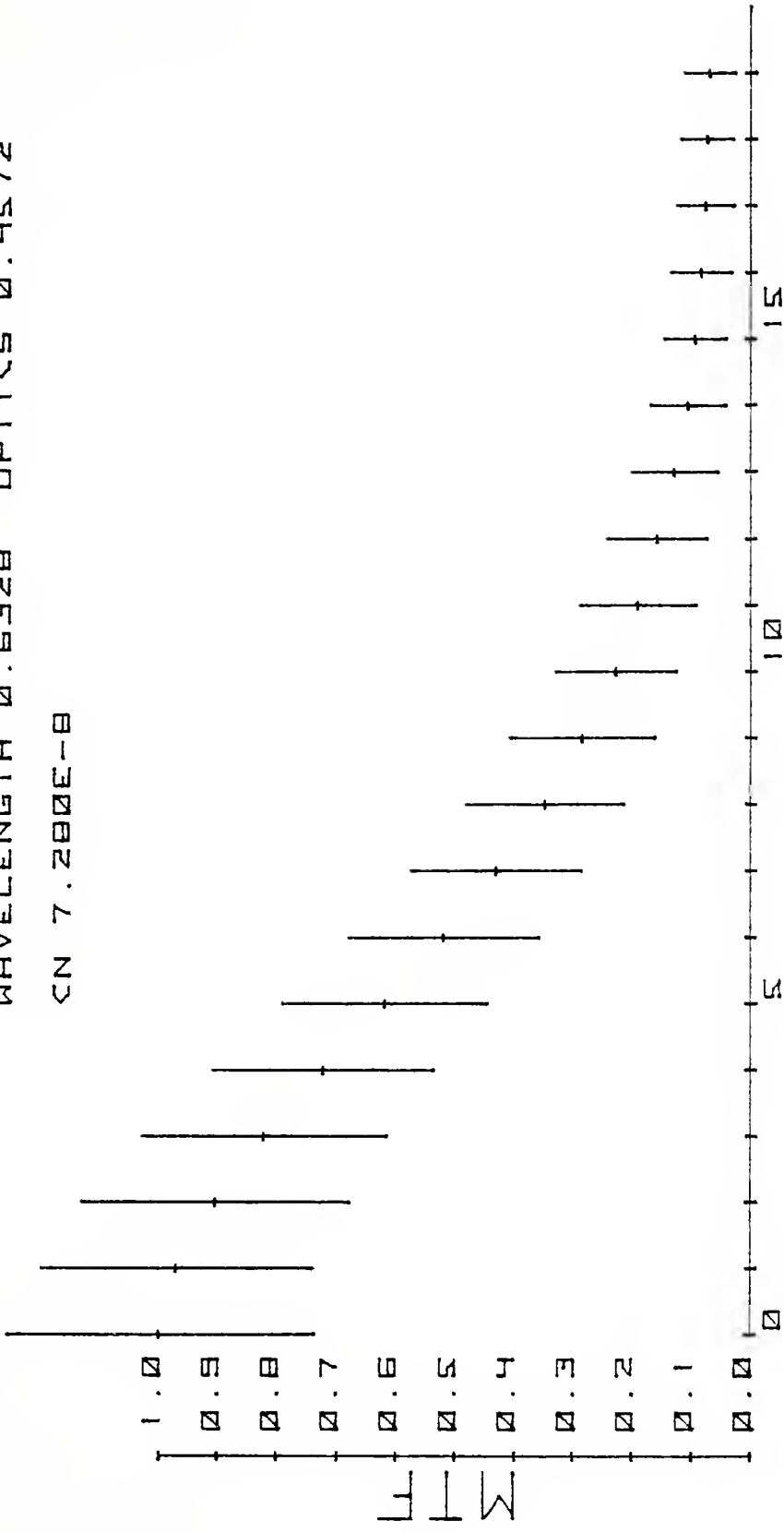

SPATIAL FREQUENCY IN 1 / MILLIRADIANS

DATA SUMMARY

DATE 21877 TIME 1035

Cn 7.350 E-8 OPTICS 0.4572

SPAT FR	MEAN	ST. DEV	TEST DIST. NORMAL		TEST DIST LN NORMAL	
			CHI SQ		CHI SQ	
0	3.27795E-02	1.76791E-02	1.45385E	01	6.47739E	01
1	3.16881E-02	1.29074E-02	3.32636E	01	1.76401E	01
2	3.02750E-02	1.28632E-02	2.97890E	01	1.12504E	01
3	2.92646E-02	1.14858E-02	2.61566E	01	1.61143E	01
4	2.58149E-02	1.10049E-02	3.84230E	01	1.62658E	01
5	2.35415E-02	9.77973E-03	2.83969E	01	1.36711E	01
6	2.06808E-02	8.56606E-03	4.11800E	01	1.63235E	01
7	1.75171E-02	8.01482E-03	2.47116E	01	1.31864E	01
8	1.51046E-02	6.87762E-03	1.85397E	01	2.79365E	01
9	1.28032E-02	6.28892E-03	1.87759E	01	2.02882E	01
10	1.03414E-02	5.40297E-03	3.25997E	01	3.82591E	01
11	9.35774E-03	4.88064E-03	2.60579E	01	3.66852E	01
12	7.29784E-03	4.14552E-03	2.26840E	01	2.87547E	01
13	6.22253E-03	3.98534E-03	2.97759E	01	2.16187E	01
14	5.73337E-03	3.31538E-03	2.18822E	01	1.91685E	01
15	5.19977E-03	3.19128E-03	3.96258E	01	2.12386E	01
16	4.98200E-03	3.20316E-03	2.70003E	01	2.45651E	01
17	4.36643E-03	2.58241E-03	2.87794E	01	1.71908E	01
18	4.08733E-03	2.64778E-03	5.58668E	01	1.43695E	01
19	4.42904E-03	2.70983E-03	2.52359E	01	2.14956E	01

MTF MEAN AND ± 1 STANDARD DEVIATION

DATE 21877 TIME 1035 NO OF SCANS 110

WAVELENGTH 0.6328 OPTICS 0.4572

CN 7.350E-8

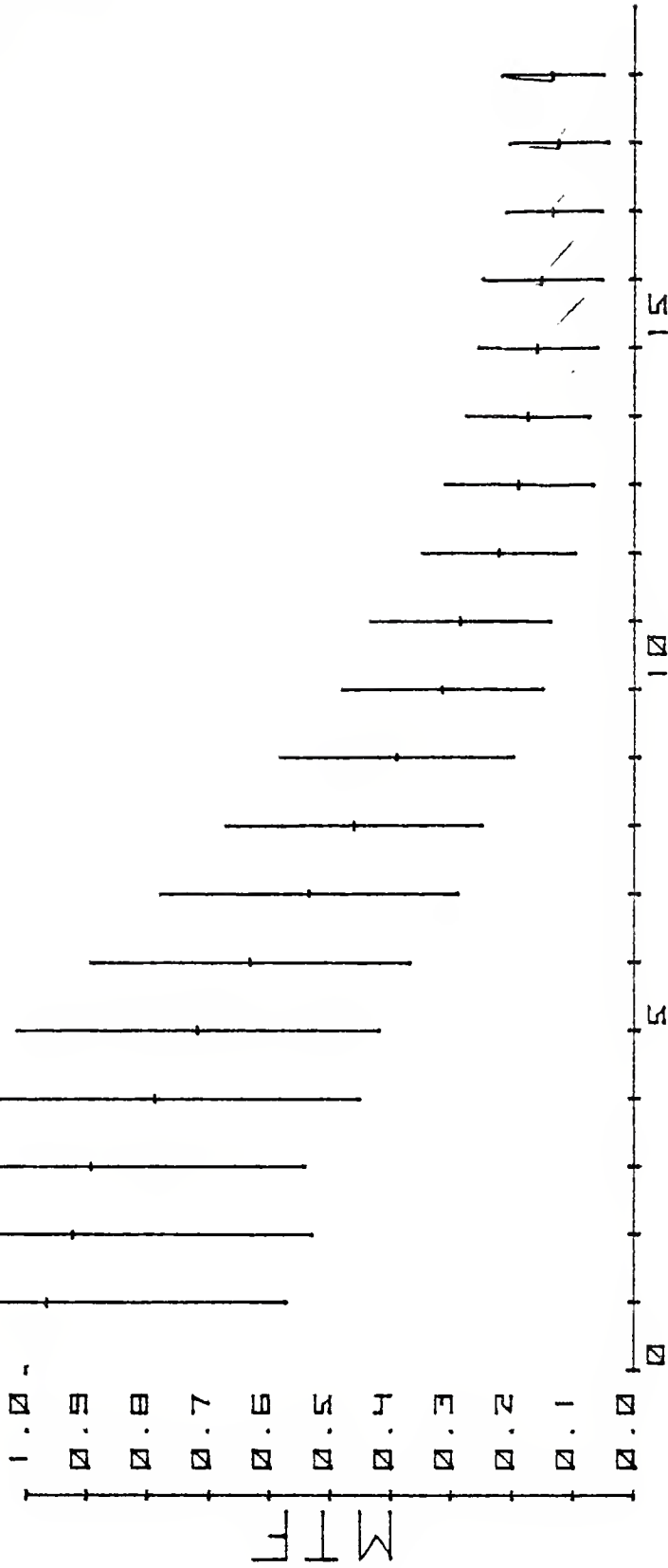

SPATIAL FREQUENCY IN 1 / MILLIRADIANS

DATA SUMMARY

DATE 21577 TIME 1635

Cn 8.230 E-8 OPTICS 0.4572

TEST DIST. NORMAL		TEST DIST LN NORMAL	
SPAT FR	MEAN	ST. DEV	CHI SQ
0	5.84172E-02	2.99783E-02	2.63393E 01
1	5.73506E-02	1.77744E-02	2.43419E 01
2	5.21276E-02	1.54392E-02	2.10055E 01
3	4.51516E-02	1.39886E-02	1.33382E 01
4	3.79575E-02	1.27293E-02	1.65664E 01
5	2.90644E-02	1.09645E-02	1.99905E 01
6	2.34214E-02	9.68872E-03	3.35699E 01
7	1.92734E-02	8.19495E-03	1.58151E 01
8	1.60044E-02	7.71834E-03	2.33597E 01
9	1.35490E-02	7.53801E-03	2.06674E 01
10	1.09735E-02	6.35264E-03	3.13052E 01
11	1.18485E-02	6.25335E-03	2.09796E 01
12	9.51318E-03	5.31737E-03	2.70530E 01
13	9.56125E-03	5.89978E-03	2.88480E 01
14	1.12661E-02	5.49113E-03	2.40150E 01
15	1.02666E-02	5.10218E-03	2.36721E 01
16	9.66538E-03	5.41075E-03	2.39174E 01
17	9.47014E-03	4.93254E-03	1.87262E 01
18	1.01555E-02	5.55411E-03	2.51106E 01
19	1.07749E-02	5.74280E-03	2.76562E 01
			CHI SQ
			5.71799E 01
			3.22373E 01
			1.75634E 01
			2.49212E 01
			2.21413E 01
			1.77474E 01
			1.30913E 01
			1.64176E 01
			3.59423E 01
			4.70020E 01
			2.50011E 01
			2.28130E 01
			3.54567E 01
			2.58023E 01
			3.27537E 01
			4.17288E 01
			2.77648E 01
			3.74433E 01
			2.36253E 01
			4.31000E 01

MTF MEAN AND ± 1 STANDARD DEVIATION

DATE 21577 TIME 1635 NO OF SCANS 125

WAVELENGTH 0.6328 OPTICS 0.4572

CN 0.230E-0

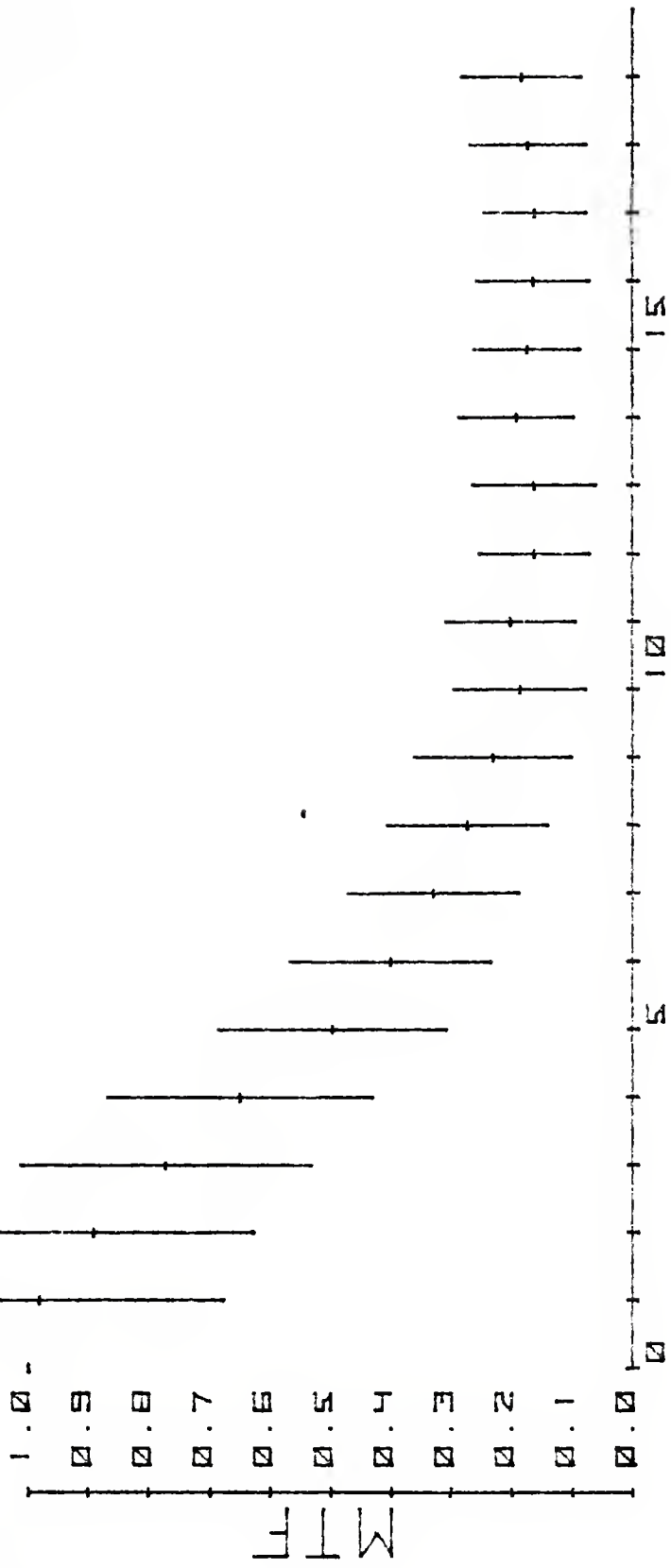

SPATIAL FREQUENCY IN 1 / MILLIRADIANS

DATA SUMMARY

DATE 21577 TIME 1600

Cn 8.560 E-8 OPTICS 0.4572

SPAT FR	MEAN	ST. DEV	TEST DIST. NORMAL		TEST DIST LN NORMAL	
			CHI SQ		CHI SQ	
0	9.98692E-02	2.21634E-02	3.13305E 01		1.62777E 01	
1	9.24153E-02	1.52389E-02	1.90068E 01		1.23048E 01	
2	8.31841E-02	1.64766E-02	1.85434E 01		1.17834E 01	
3	7.30034E-02	1.84810E-02	3.43092E 01		1.91376E 01	
4	6.07046E-02	1.93779E-02	3.97176E 01		2.20518E 01	
5	4.99413E-02	1.84424E-02	4.12893E 01		2.10634E 01	
6	3.96347E-02	1.60832E-02	3.01625E 01		1.45112E 01	
7	3.20854E-02	1.44463E-02	2.89512E 01		1.24136E 01	
8	2.44811E-02	1.28373E-02	3.68396E 01		2.24756E 01	
9	1.98511E-02	1.31828E-02	4.29000E 01		2.65319E 01	
10	1.59084E-02	1.33721E-02	6.20975E 01		1.85664E 01	
11	1.48973E-02	1.35413E-02	7.02409E 01		3.75502E 01	
12	1.20495E-02	1.34538E-02	8.98033E 01		1.74950E 01	
13	1.05067E-02	1.27060E-02	1.14864E 02		3.46729E 01	
14	9.33923E-03	1.18985E-02	1.42308E 02		2.51557E 01	
15	9.09721E-03	1.08600E-02	1.20261E 02		2.40430E 01	
16	9.17471E-03	1.00889E-02	1.08463E 02		3.00071E 01	
17	8.43004E-03	9.30431E-03	1.01217E 02		2.65896E 01	
18	8.14243E-03	8.33984E-03	7.75543E 01		3.40769E 01	
19	8.72050E-03	8.53443E-03	8.03046E 01		4.02361E 01	

MTF MEAN AND + - 1 STANDARD DEVIATION
 DATE 21577 TIME 1600 NO OF SCANS 126
 WAVELENGTH 0.6320 OPTICS 0.4572
 CN 0.660E-0

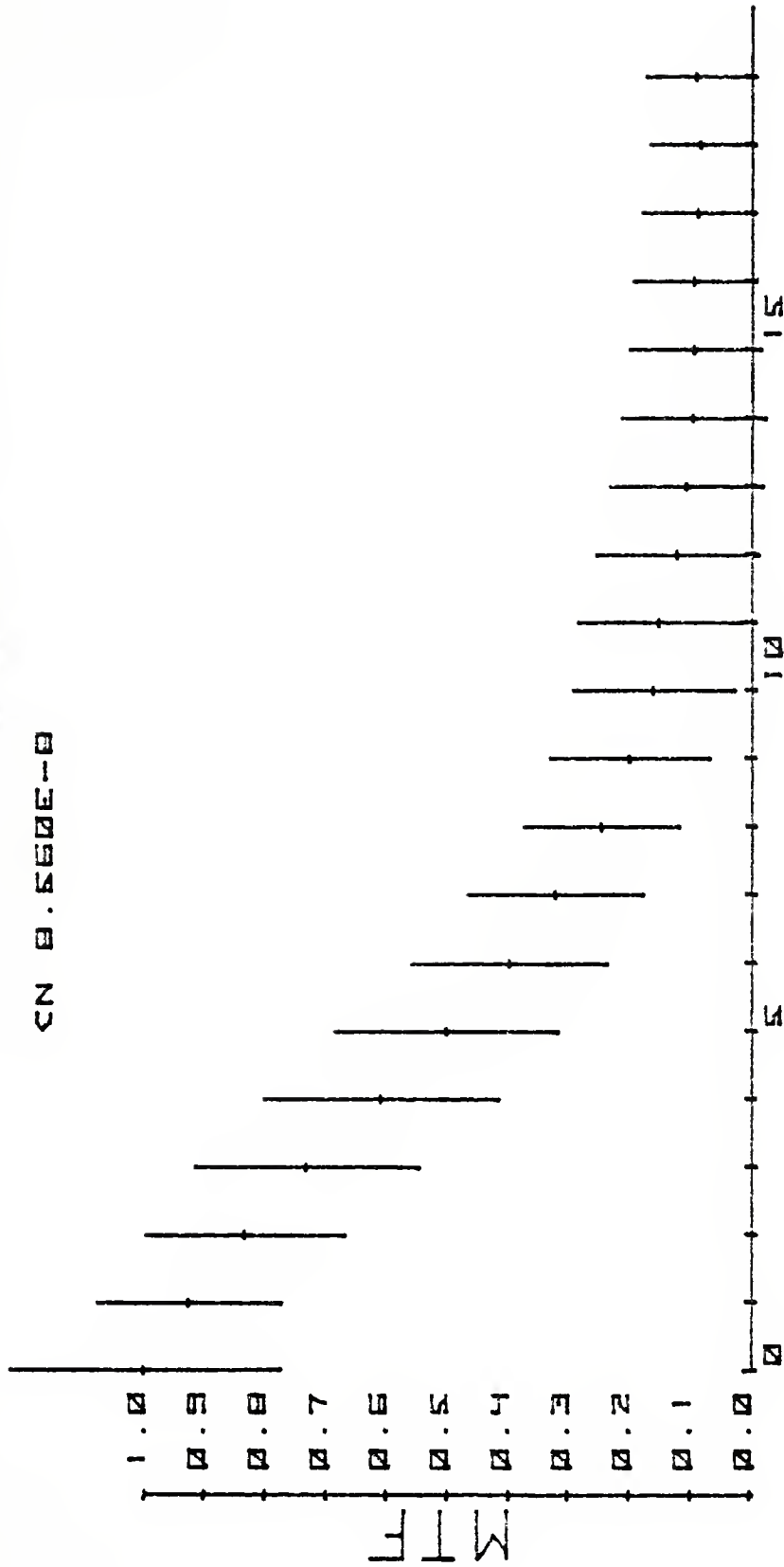

SPATIAL FREQUENCY IN 1 / MILLIRADIANS

RELATIVE DISTRIBUTION OF MTF

SPATIAL FREQUENCY 0 MEAN 5.96432E-02
 NO OF SCANS 100 ST. DEV 2.13149E-02
 TEST DIST NORMAL CHI SQ 2.50799E 01
 WAVELENGTH 0.6328 CN 2.790E-0

DATE 92177 TIME 1555

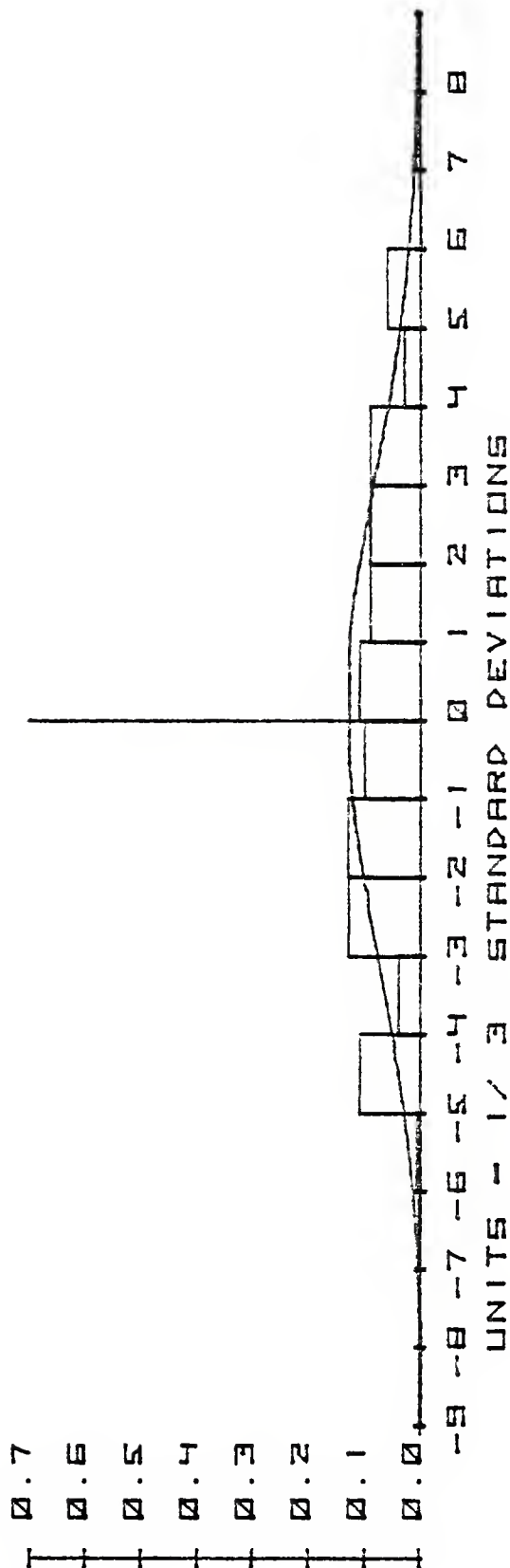

RELATIVE DISTRIBUTION OF MTF

SPATIAL FREQUENCY 1 MEAN 5.85453E-02
 NO OF SCANS 100 ST. DEV 1.92726E-02
 TEST DIST NORMAL CHI SQ 2.76983E 01
 WAVELENGTH 0.6328 CN 2.790E-8
 OPTICS 0.4572

DATE 92177 TIME 1555

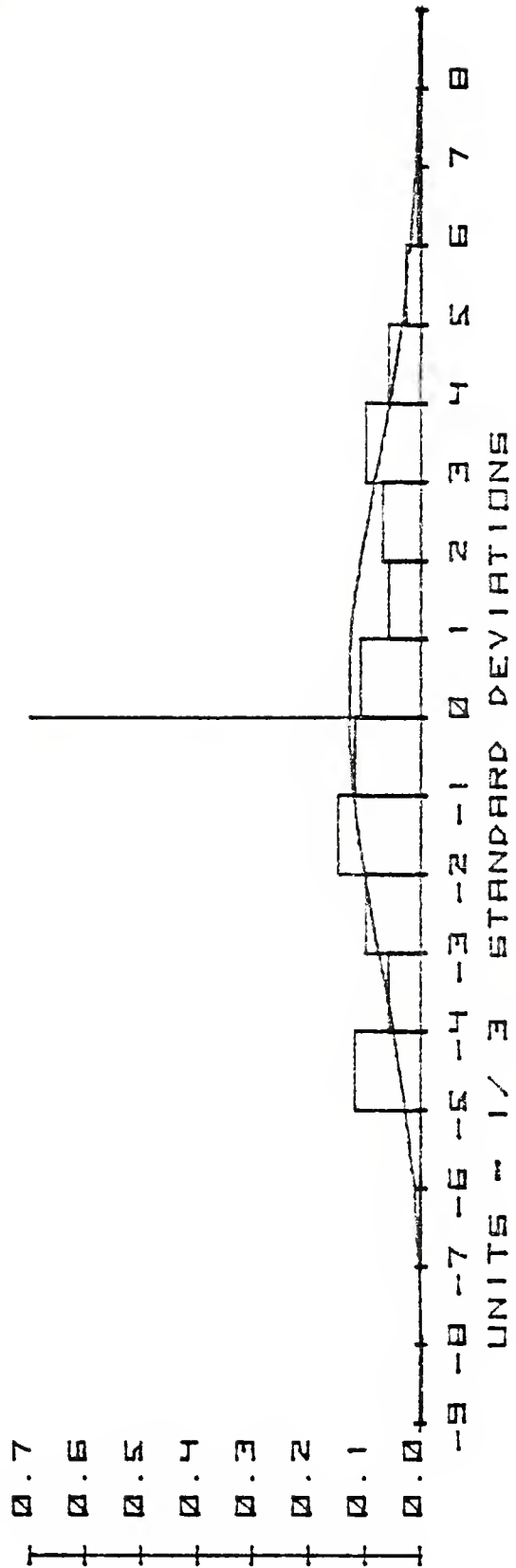

RELATIVE DISTRIBUTION OF MTF

SPATIAL FREQUENCY 2 MEAN 5.71572E-02
 NO OF SCANS 100 ST. DEV 1.88250E-02
 TEST DIST NORMAL CHI SQ 2.50227E 01
 WAVELENGTH 0.6328 CN 2.790E-8
 OPTICS 0.4572

DATE 92177 TIME 1555

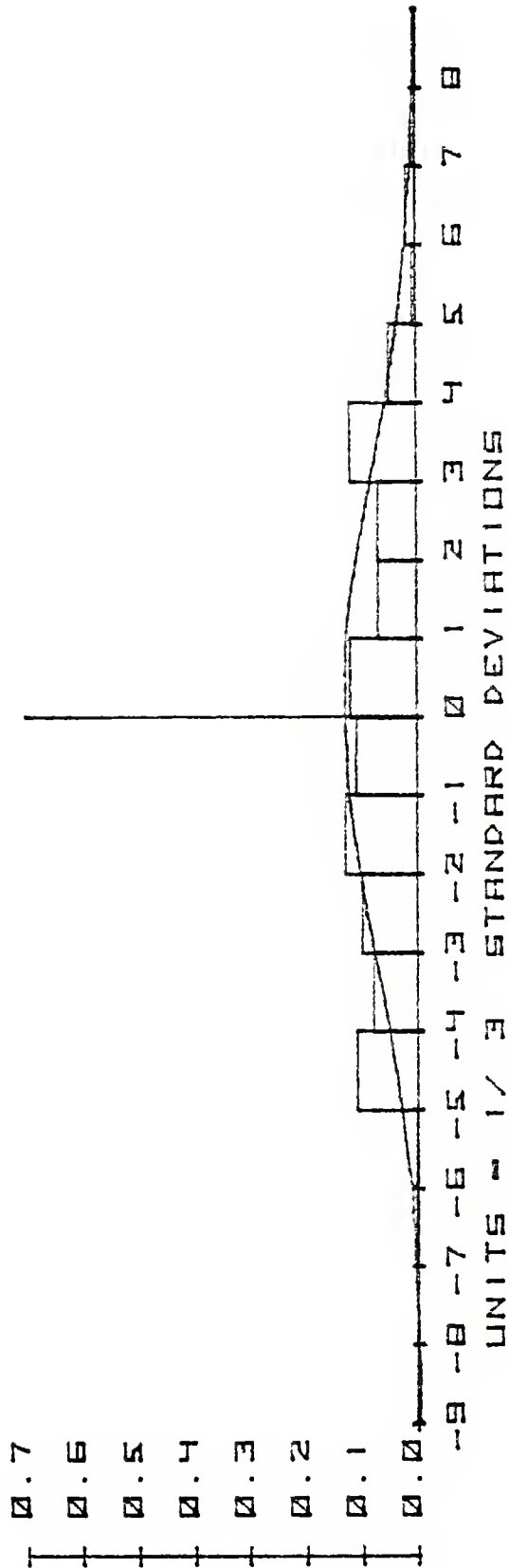

RELATIVE DISTRIBUTION OF MTF

SPATIAL FREQUENCY 3 MEAN 5.65614E-02
 NO OF SCANS 100 ST. DEV 1.86214E-02
 TEST DIST NORMAL CHI SQ 3.08980E 01
 WAVELENGTH 0.6328 CN 2.790E-8
 OPTICS 0.4572

DATE 92177 TIME 1555

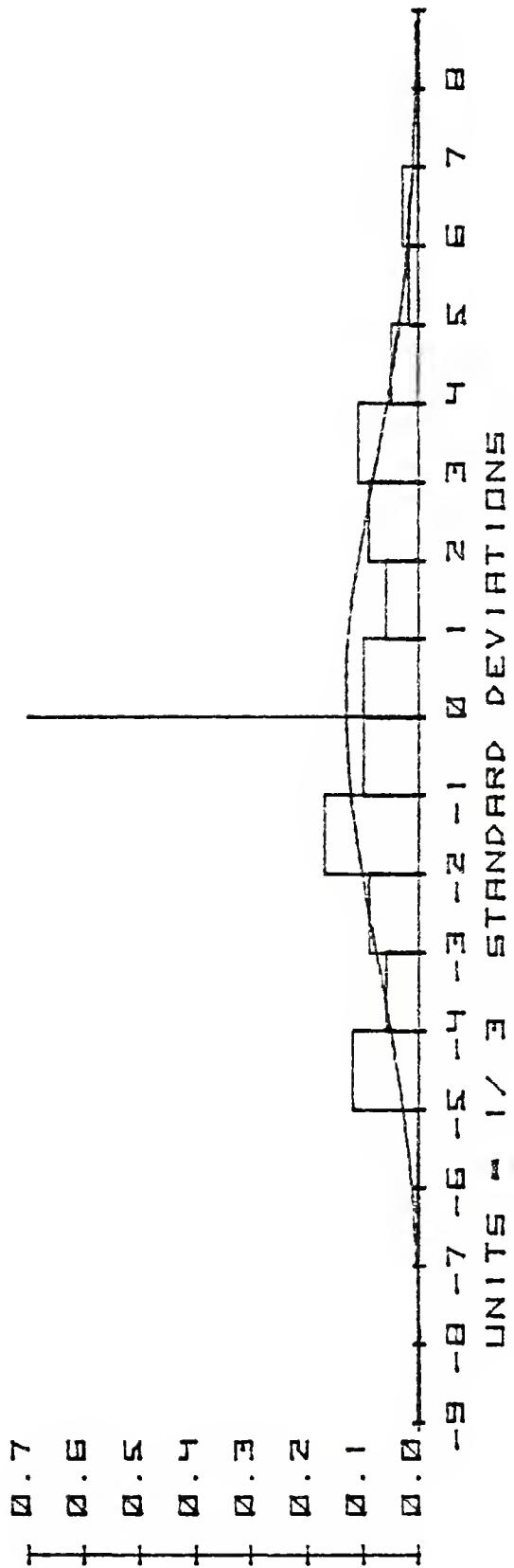

RELATIVE DISTRIBUTION OF MTF

SPATIAL FREQUENCY 4 MEAN 5.45106E-02
 NO OF SCANS 100 ST. DEV 1.81653E-02
 TEST DIST NORMAL CHI SQ 2.88112E 01
 WAVELENGTH 0.6328 CN 2.790E-8
 OPTICS 0.4572

DATE 92177 TIME 1555

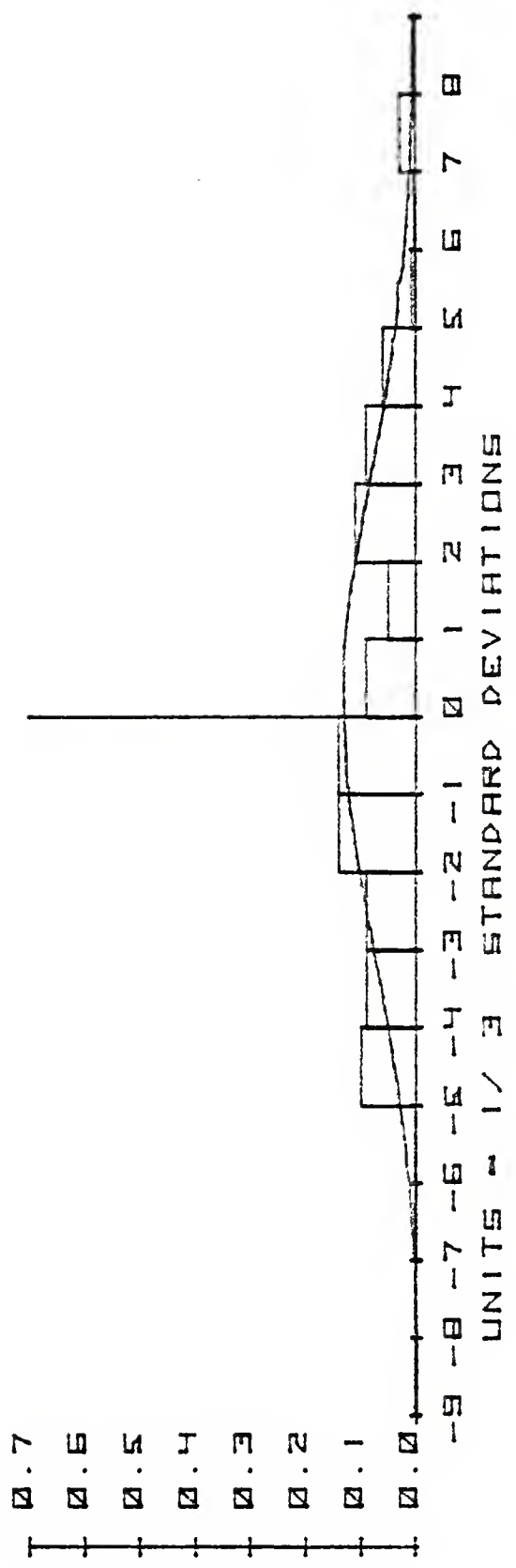

RELATIVE DISTRIBUTION OF MTF

SPATIAL FREQUENCY S MEAN 5.34043E-02
 NO OF SCANS 100 ST. DEV 1.77426E-02
 TEST DIST NORMAL CHI SQ 2.86308E 01
 WAVELENGTH 0.6328 CN 2.790E-8

OPTICS 0.4572

DATE 82177 TIME 1555

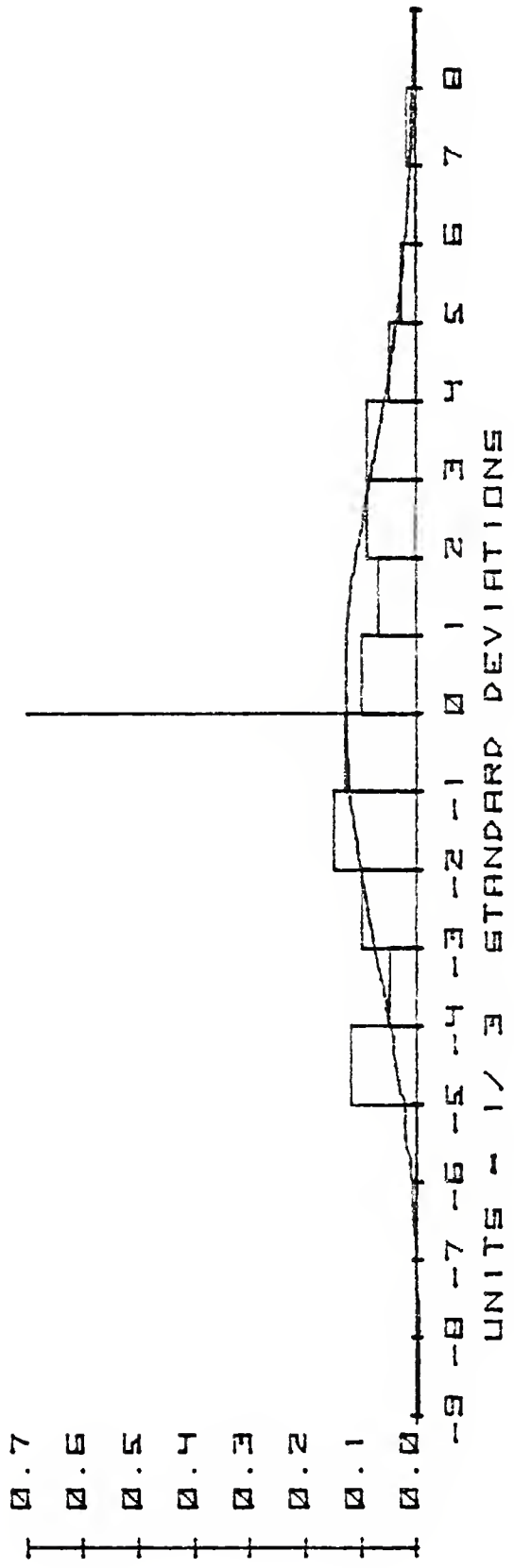

RELATIVE DISTRIBUTION OF MTF

SPATIAL FREQUENCY 6 MEAN 5.10345E-02
 NO OF SCANS 100 ST. DEV 1.72959E-02
 TEST DIST NORMAL CHI SQ 2.19200E 01
 WAVELENGTH 0.6328 CN 2.790E-0
 OPTICS 0.4572

DATE 92177 TIME 1555

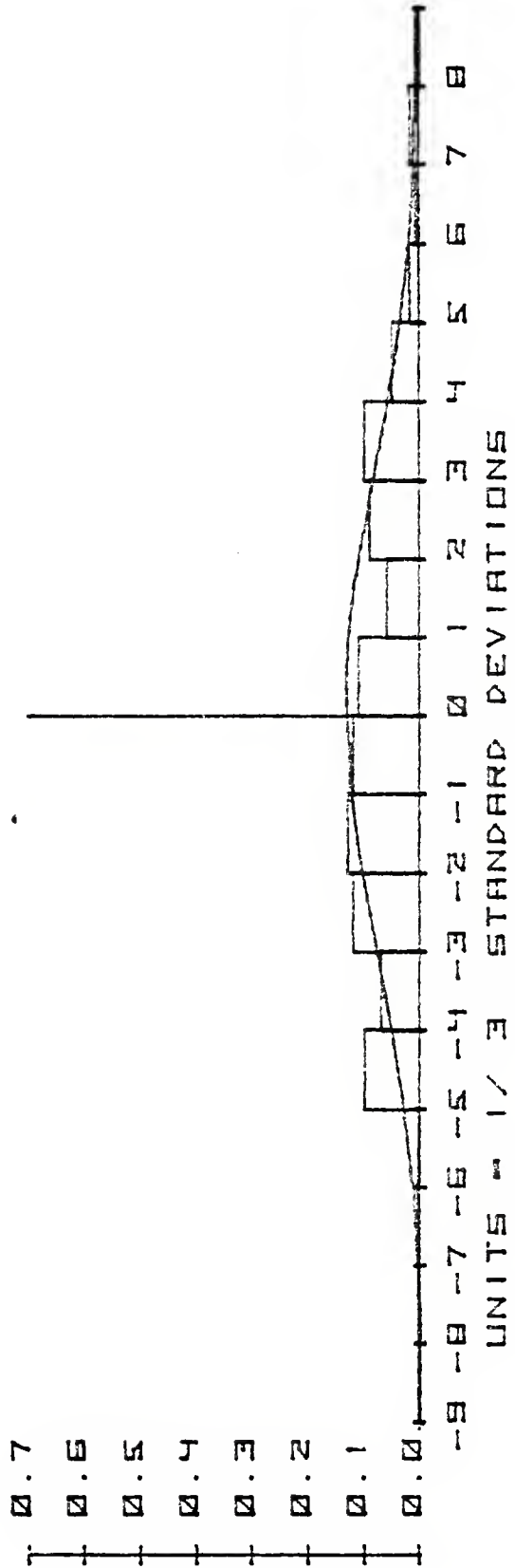

RELATIVE DISTRIBUTION OF MTF

SPATIAL FREQUENCY 7 MEAN 4.92243E-02
 NO OF SCANS 100 ST. DEV 1.67257E-02
 TEST DIST NORMAL CHI SQ 3.22522E 01
 WAVELENGTH 0.6328 CN 2.790E-8
 OPTICS 0.4572

DATE 92177 TIME 1555

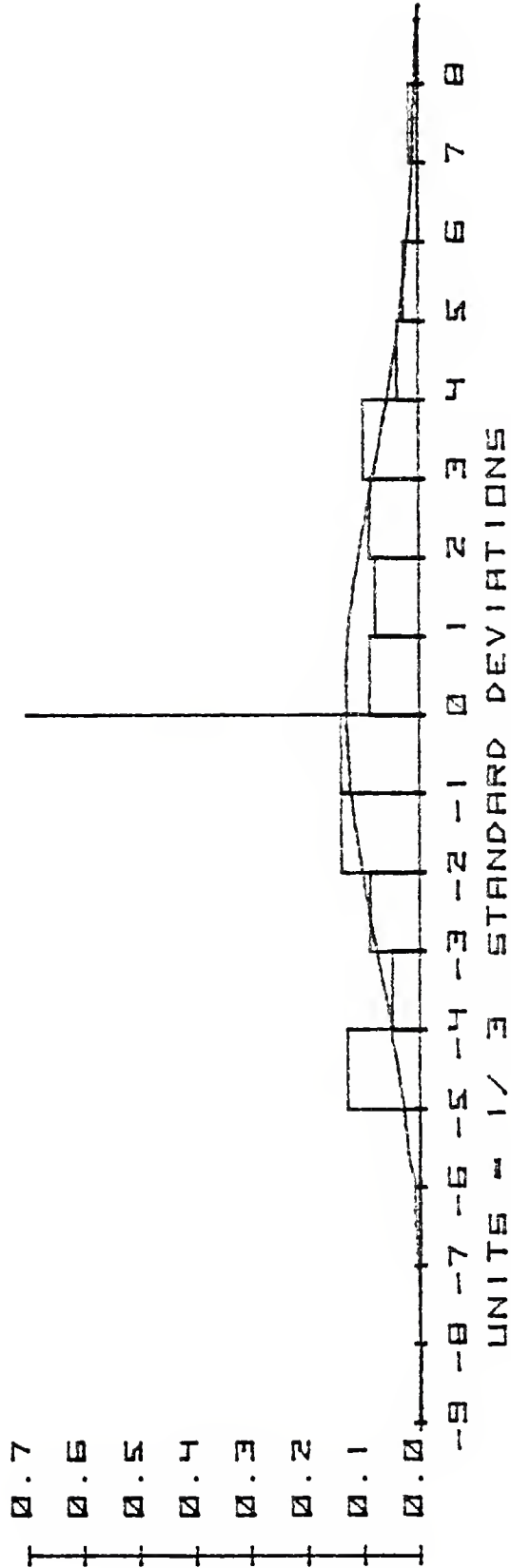

RELATIVE DISTRIBUTION OF MTF

SPATIAL FREQUENCY θ MEAN 4.68538E-02
 NO OF SCANS 100 ST. DEV 1.61444E-02
 TEST DIST NORMAL CHI SQ 1.98058E 01
 WAVELENGTH 0.6328 CN 2.790E-8
 OPTICS 0.4572

DATE 92177 TIME 1555

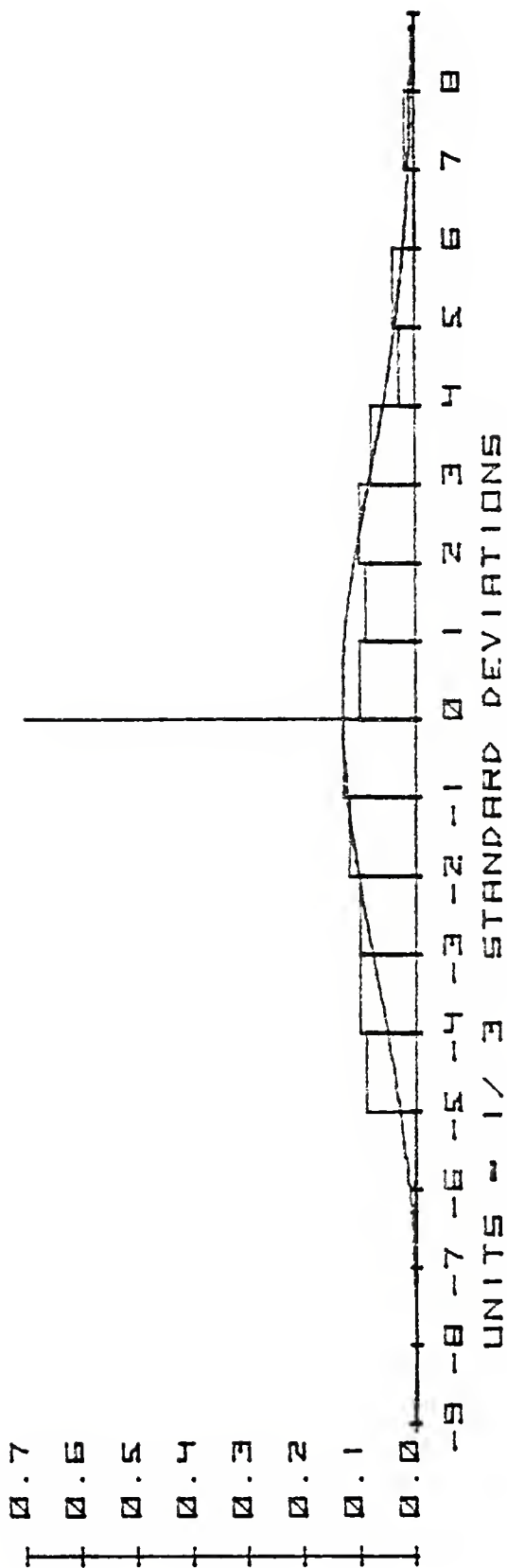

RELATIVE DISTRIBUTION OF MTF

SPATIAL FREQUENCY 9 MEAN 4.52000E-02
 NO OF SCANS 100 ST. DEV 1.55913E-02
 TEST DIST NORMAL CHI SQ 2.46706E 01
 WAVELENGTH 0.6328 CN 2.790E-08
 OPTICS 0.4572

DATE 92177 TIME 1555

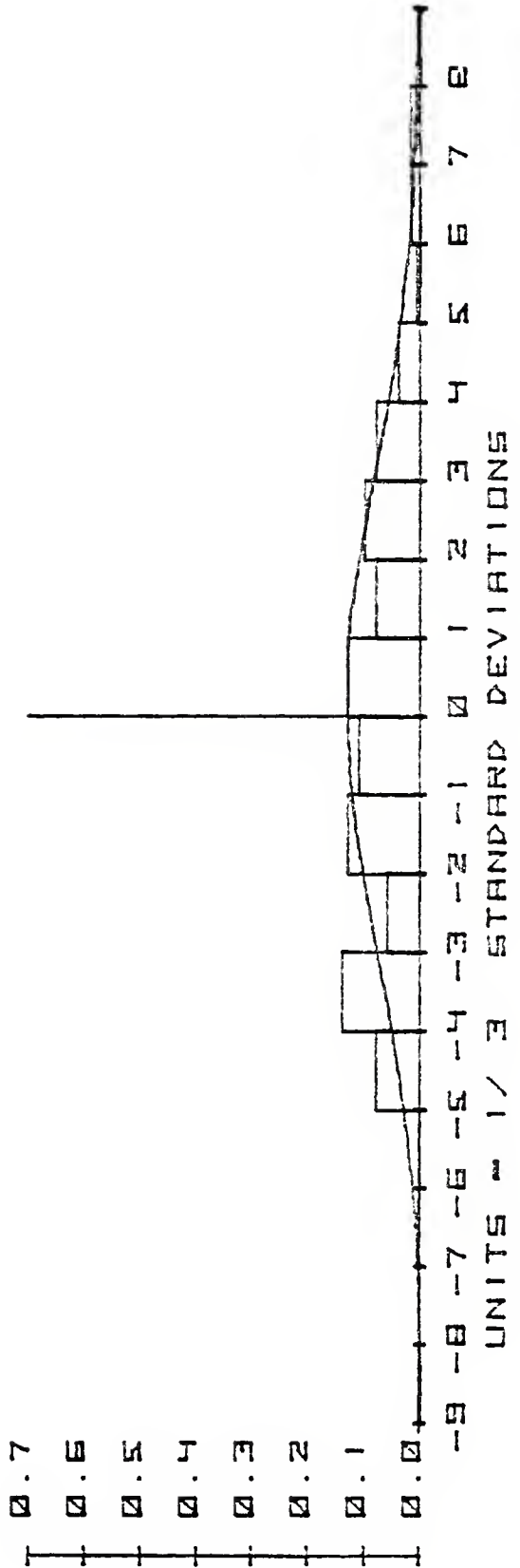

RELATIVE DISTRIBUTION OF MTF

SPATIAL FREQUENCY 10 MEAN 4.20157E-02
 NO OF SCANS 100 ST. DEV 1.50546E-02
 TEST DIST NORMAL CHI SQ 2.40792E 01
 WAVELENGTH 0.6320 CN 2.790E-0

DATE 92177 TIME 1555

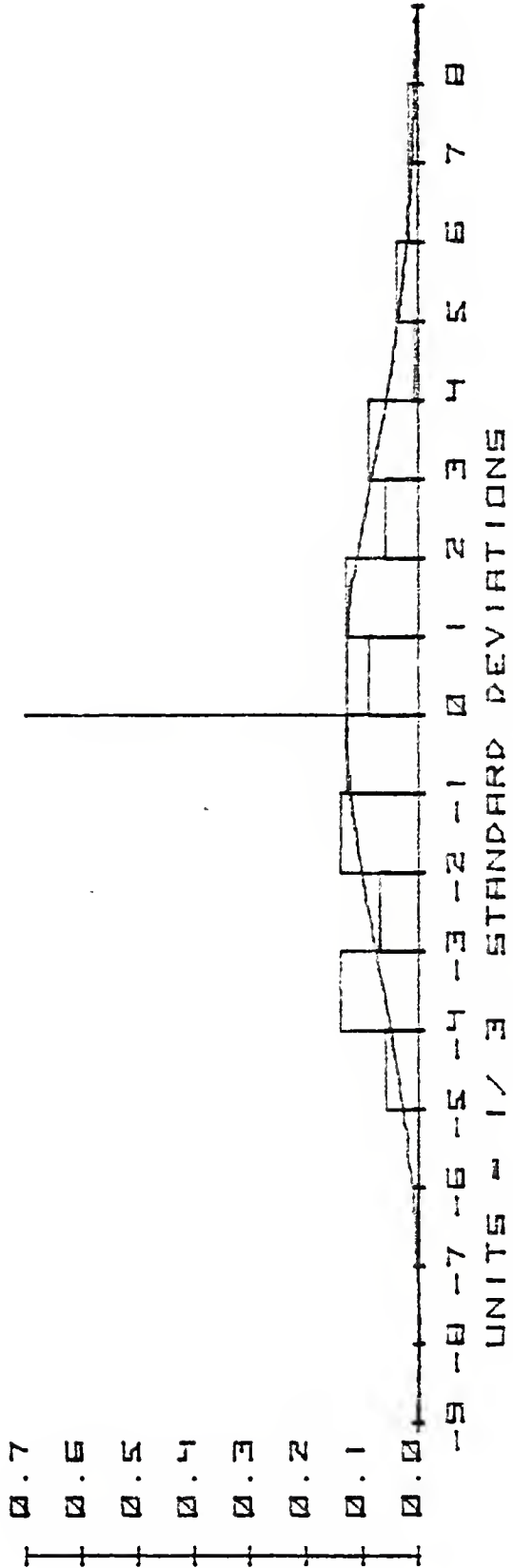

RELATIVE DISTRIBUTION OF MTF

SPATIAL FREQUENCY 11 MEAN 4.09039E-02
 NO OF SCANS 100 ST. DEV 1.49076E-02
 TEST DIST NORMAL CHI SQ 2.41547E 01
 WAVELENGTH 0.6328 CN 2.790E-8
 OPTICS 0.4572

DATE 92177 TIME 1555

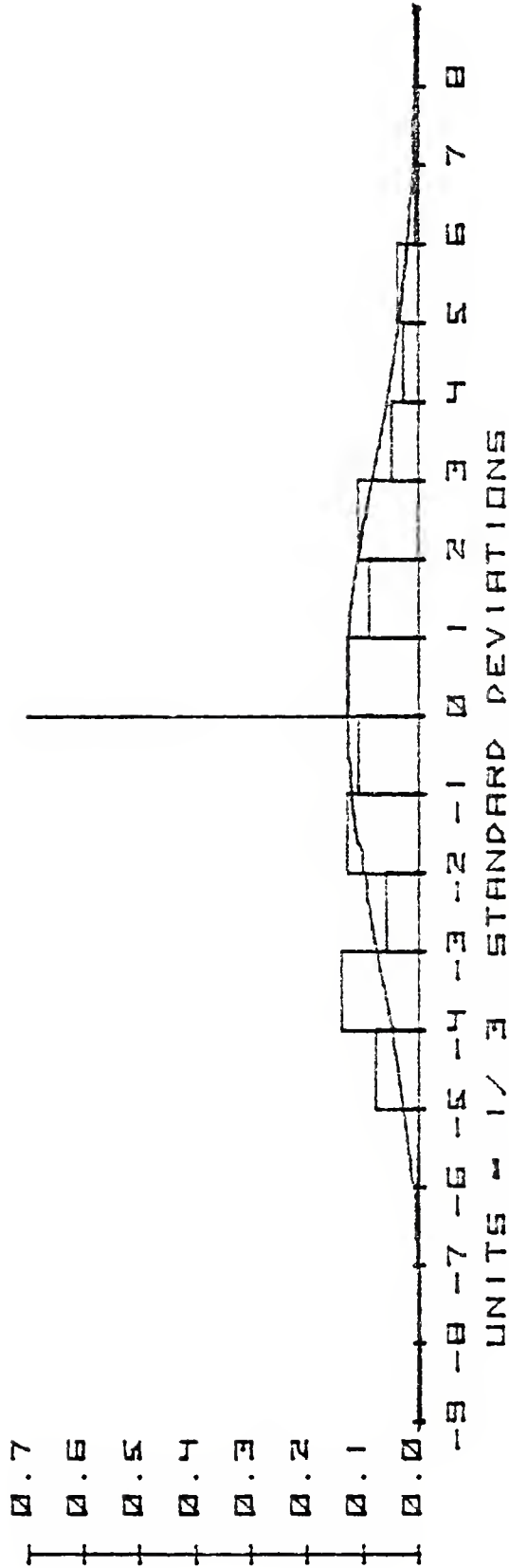

RELATIVE DISTRIBUTION OF MTF

SPATIAL FREQUENCY 12 MEAN 3.00307E-02
 NO OF SCANS 100 ST. DEV 1.44746E-02
 TEST DIST NORMAL CHI SQ 2.73054E 01
 WAVELENGTH 0.6328 CN 2.790E-8
 OPTICS 0.4572

DATE 92177 TIME 1556

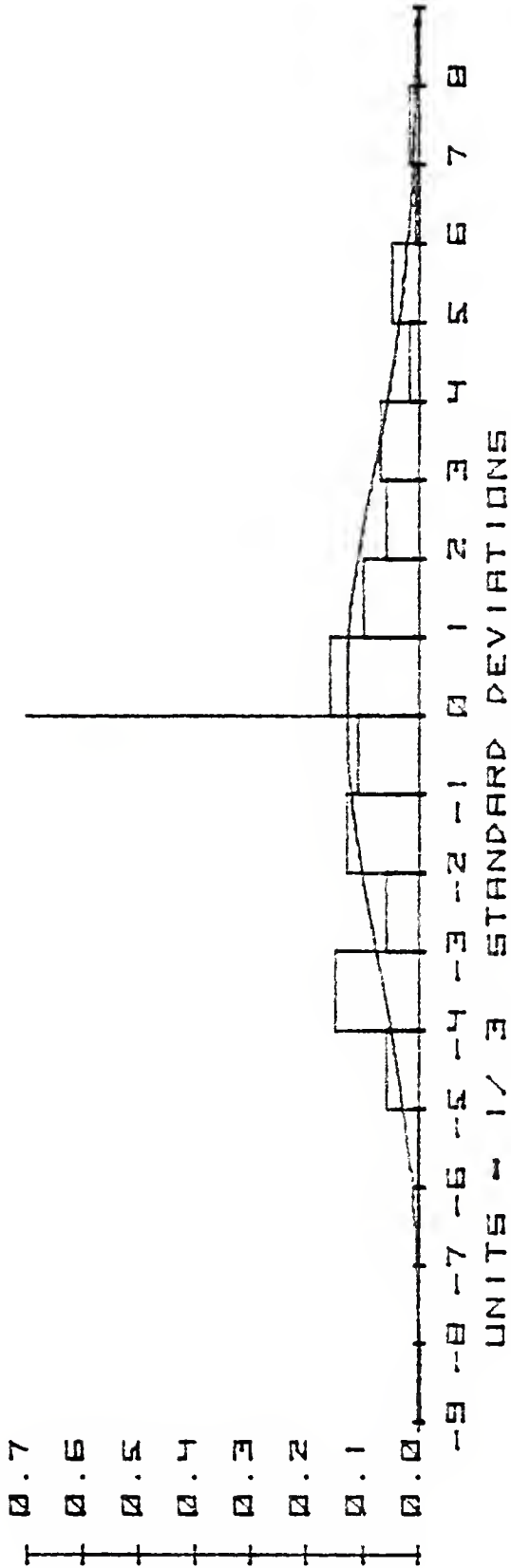

RELATIVE DISTRIBUTION OF MTF

SPATIAL FREQUENCY 13 MEAN 3.70327E-02
 NO OF SCANS 100 ST. DEV 1.41457E-02
 TEST DIST NORMAL CHI SQ 2.93271E 01
 WAVELENGTH 0.6328 CN 2.790E-8
 OPTICS 0.4572

DATE 92177 TIME 1555

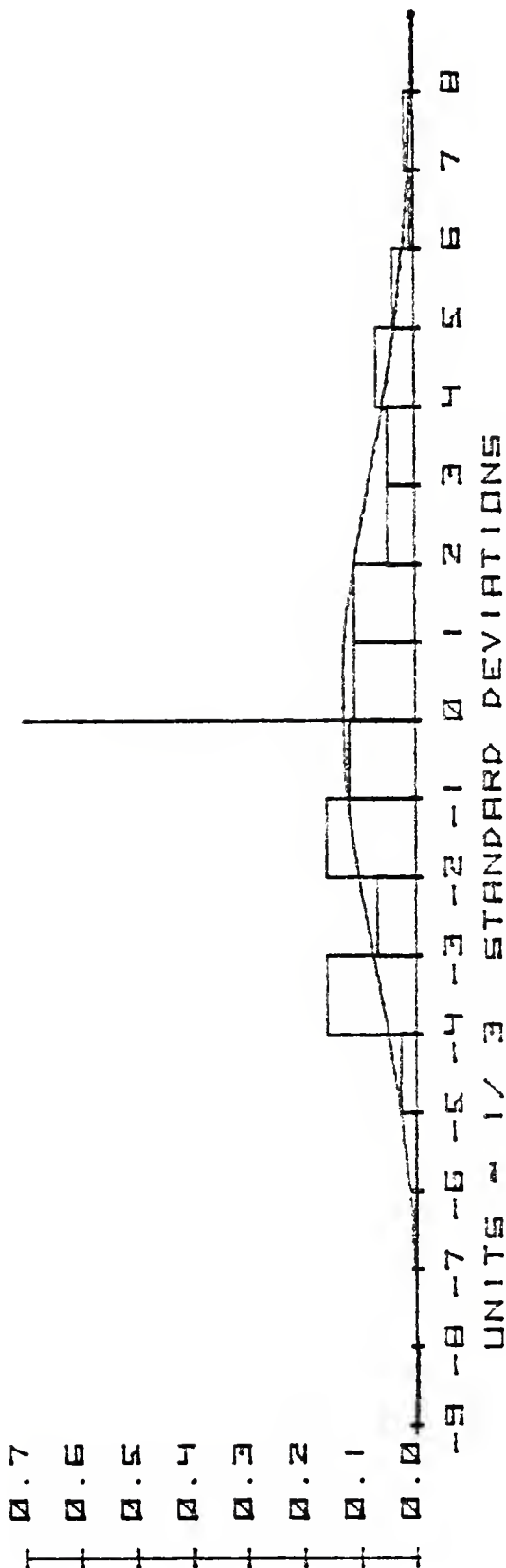

RELATIVE DISTRIBUTION OF MTF

SPATIAL FREQUENCY IS MEAN 3.25474E-02
 NO OF SCANS 100 ST. DEV 1.30310E-02
 TEST DIST NORMAL CHI SQ 2.05478E 01
 WAVELENGTH 0.6328 CN 2.790E-0
 OPTICS 0.4572

DATE 92177 TIME 1555

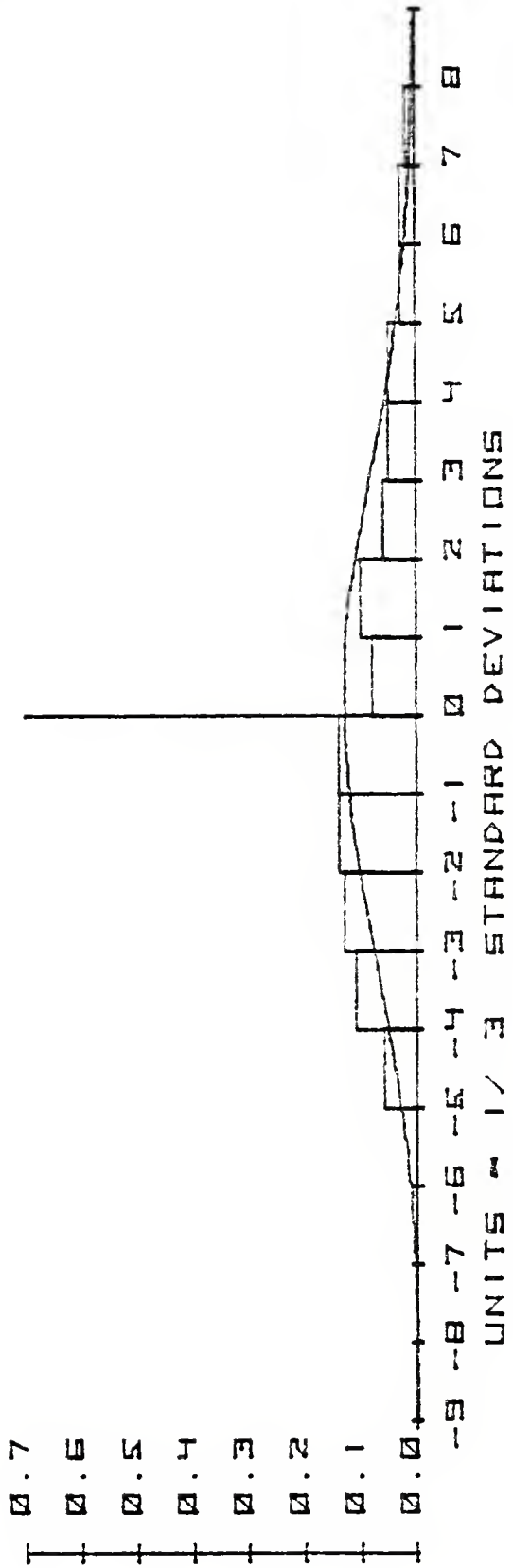

RELATIVE DISTRIBUTION OF MTF

SPATIAL FREQUENCY 17 MEAN 2.91681E-02
 NO OF SCANS 100 ST. DEV 1.30149E-02
 TEST DIST NORMAL CHI SQ 2.54938E 01
 WAVELENGTH 0.6328 CN 2.790E-8
 OPTICS 0.4572

DATE 92177 TIME 1555

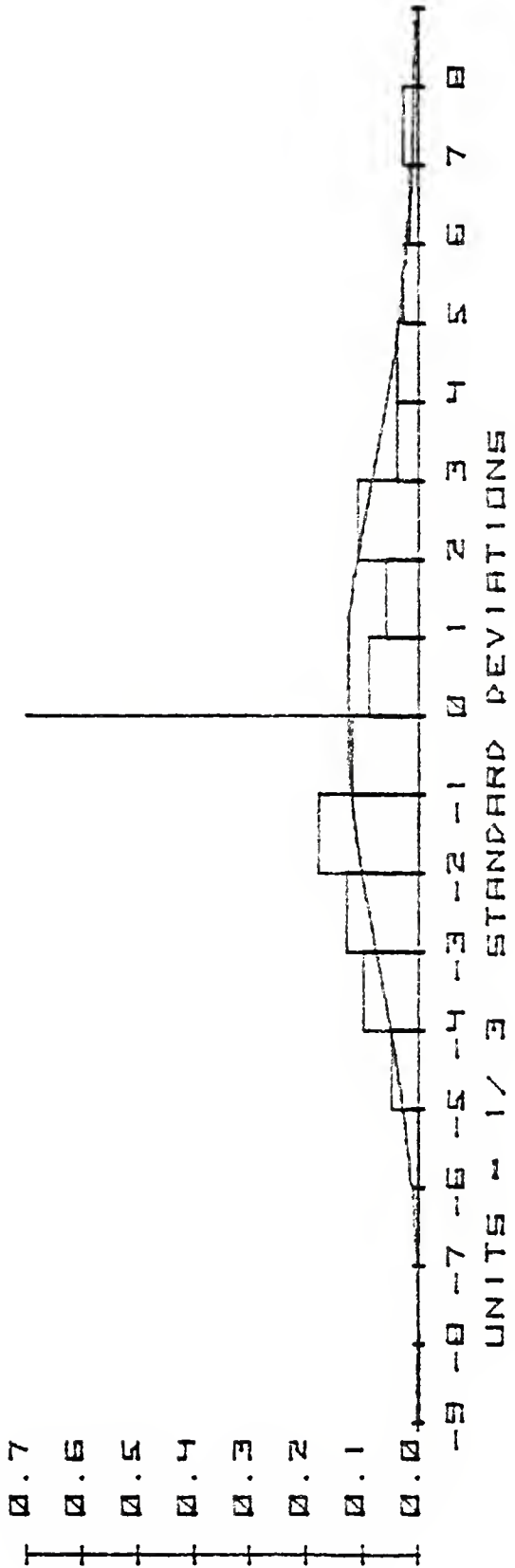

RELATIVE DISTRIBUTION OF MTF

SPATIAL FREQUENCY 19 MEAN 2.62632E-02
 NO OF SCANS 100 ST. DEV 1.29964E-02
 TEST DIST NORMAL CHI SQ 4.01706E 01
 WAVELENGTH 0.6328 CN 2.790E-0

DATE 92177 TIME 1556

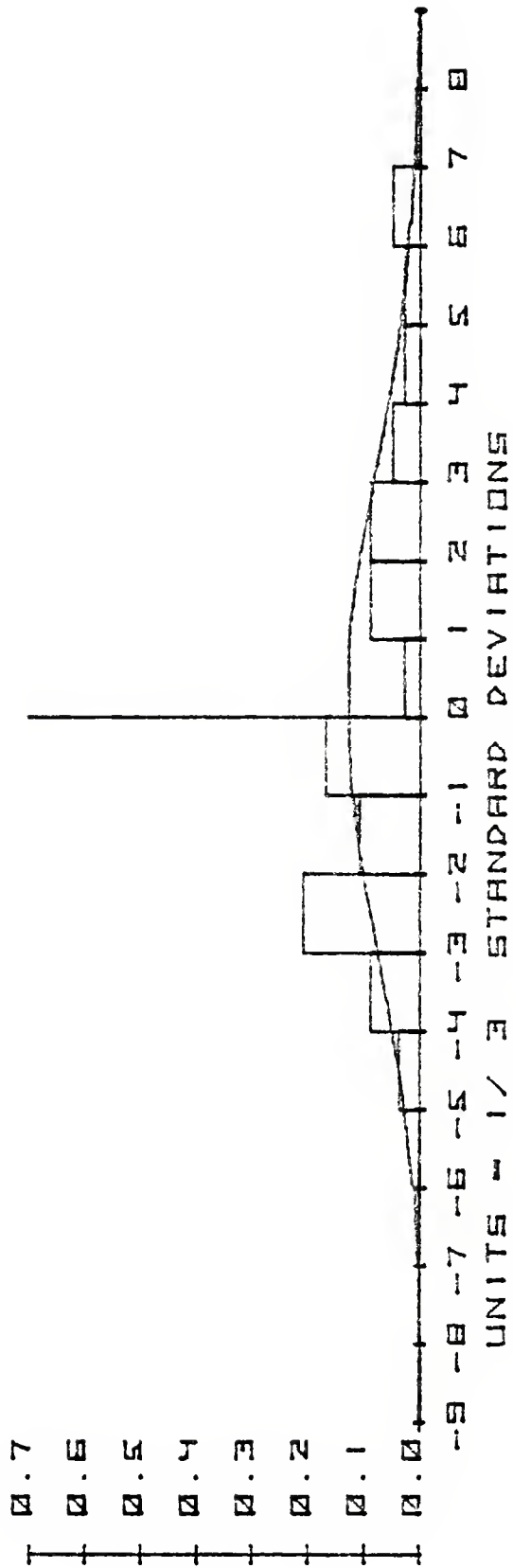

RELATIVE DISTRIBUTION OF MTF

SPATIAL FREQUENCY 0 MEAN-2.89019E 00
 NO OF SCANS 100 ST. DEV 3.93545E-01
 TEST DIST LN NORMAL CHI SQ 2.08758E 01
 WAVELENGTH 0.6328 CN 2.790E-8
 OPTICS 0.4572

DATE 92177 TIME 1555

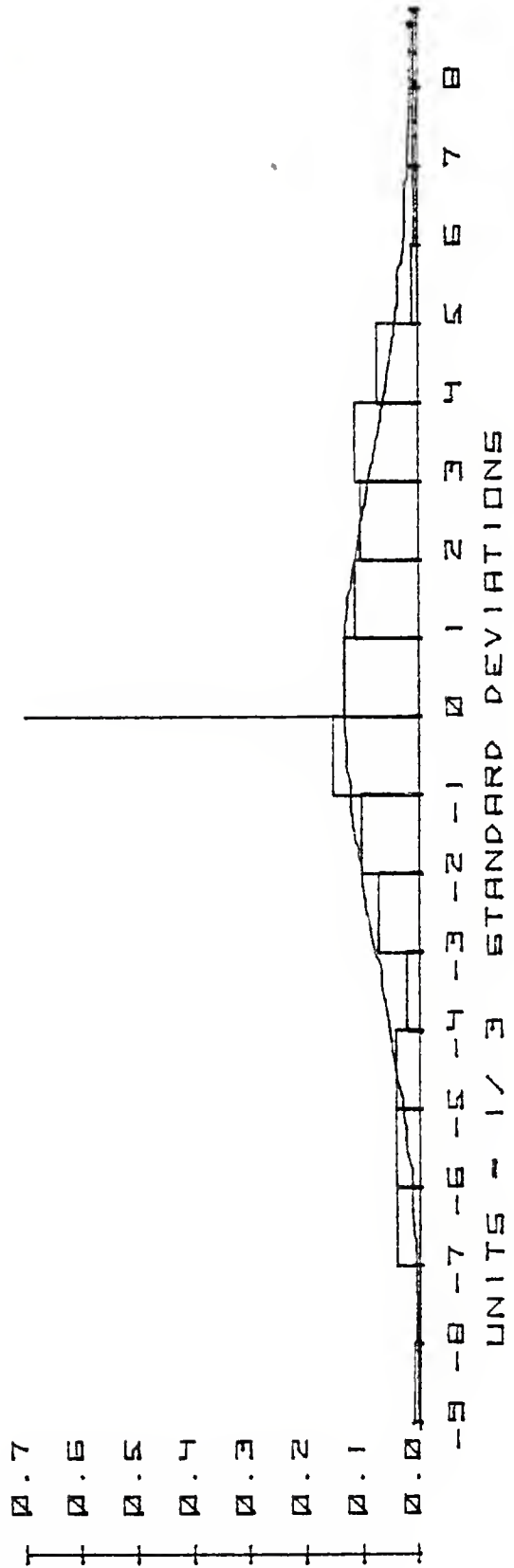

RELATIVE DISTRIBUTION OF MTF

SPATIAL FREQUENCY I MEAN-2.89495E 00
 NO OF SCANS 100 ST. DEV 3.46806E-01
 TEST DIST LN NORMAL CHI SQ 2.65750E 01
 WAVELENGTH 0.6328 CN 2.7900E-8
 OPTICS 0.4572

DATE 92177 TIME 1555

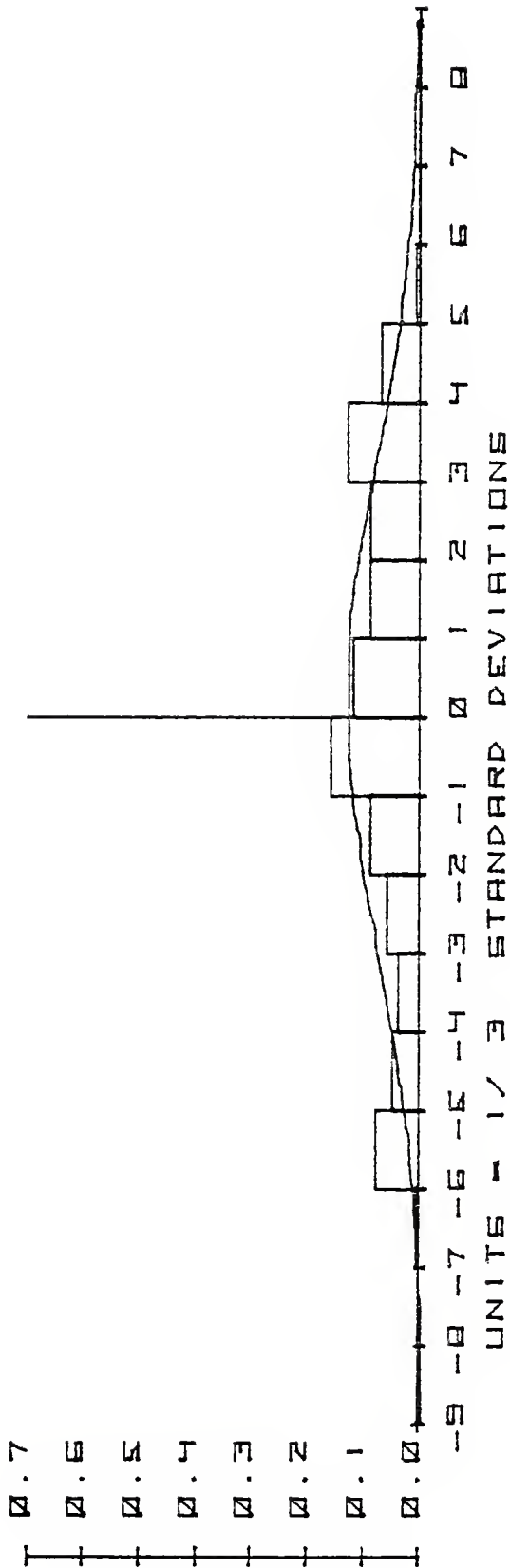

RELATIVE DISTRIBUTION OF MTF

SPATIAL FREQUENCY 2 MEAN-2.91814E 00
 NO OF SCANS 100 ST. DEV 3.42794E-01
 TEST DIST LN NORMAL CHI SQ 3.13476E 01
 WAVELENGTH 0.6328 CN 2.790E-8
 OPTICS 0.4572

DATE 92177 TIME 1555

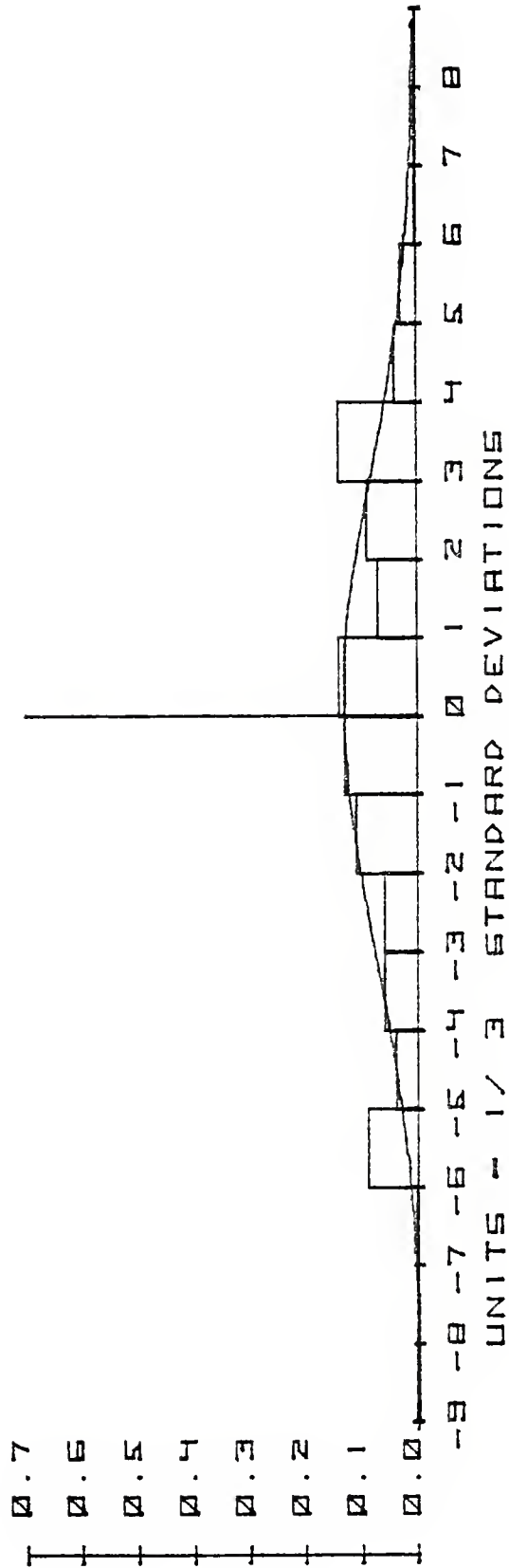

RELATIVE DISTRIBUTION OF MTF

SPATIAL FREQUENCY 5 MEAN-2.98699E 00
 NO OF SCANS 100 ST. DEV 3.45619E-01
 TEST DIST LN NORMAL CHI SQ 2.70611E 01
 WAVELENGTH 0.6328 CN 2.790E-8
 OPTICS 0.4572

DATE 92177 TIME 1555

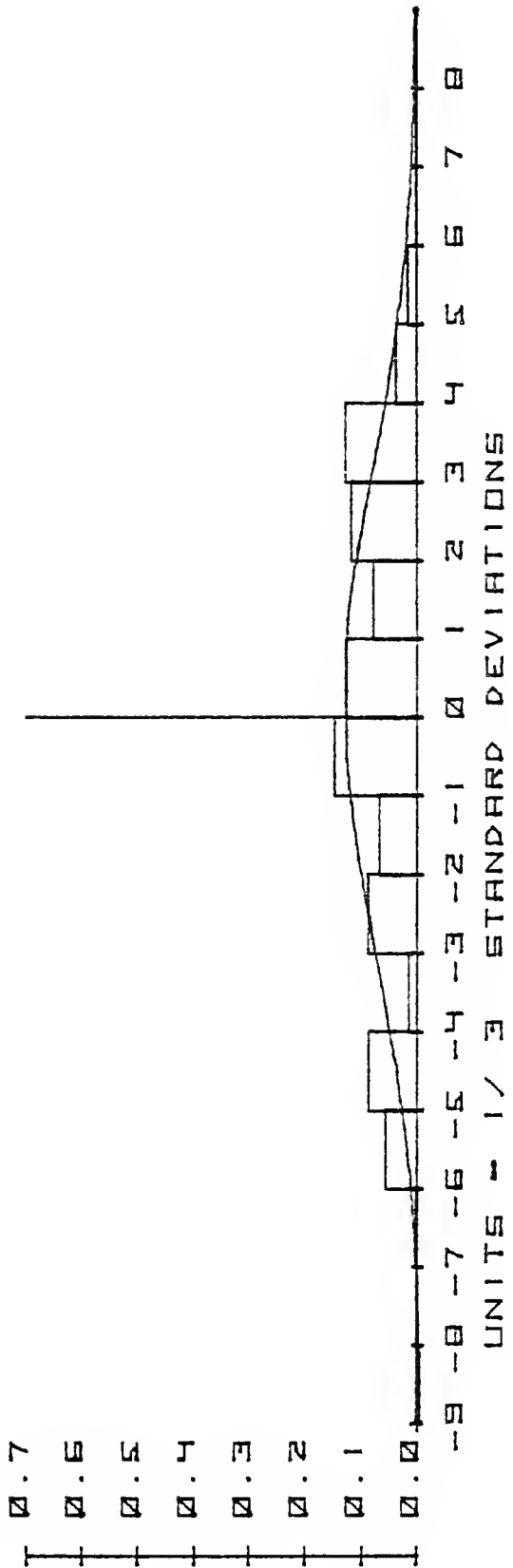

RELATIVE DISTRIBUTION OF MTF

SPATIAL FREQUENCY 7 MEAN-3.07103E 00
 NO OF SCANS 100 ST. DEV 3.53103E-01
 TEST DIST LN NORMAL CHI SQ 2.40727E 01
 WAVELENGTH 0.6328 CN 2.790E-8
 OPTICS 0.4572

DATE 92177 TIME 1555

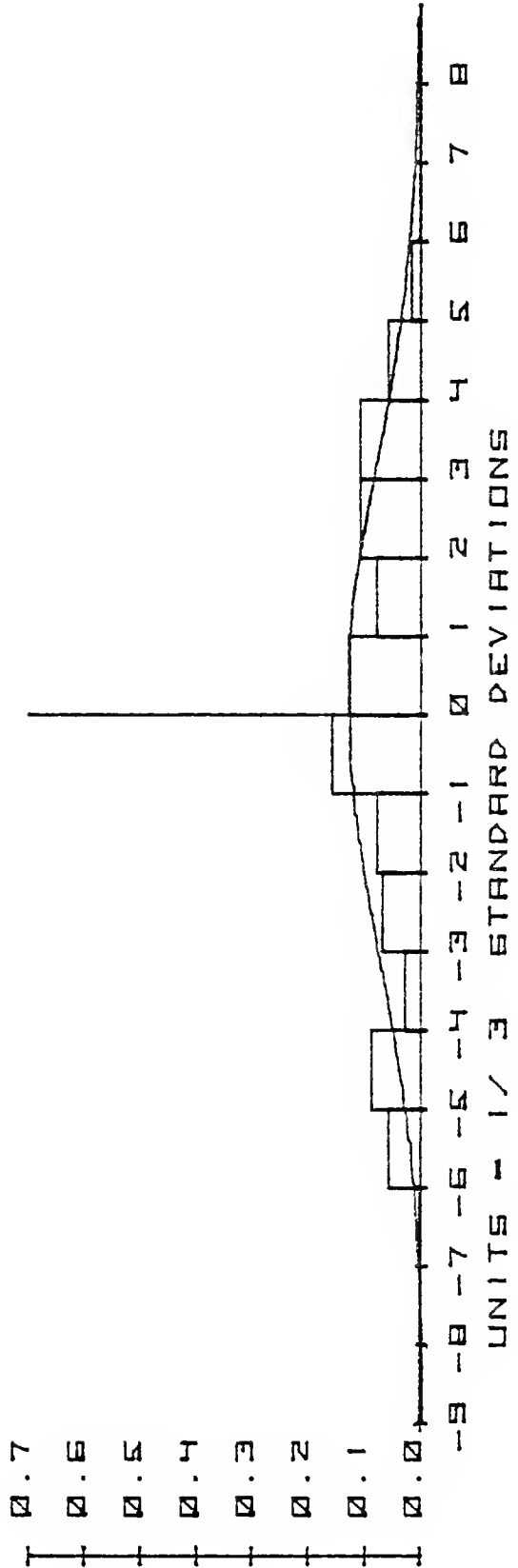

RELATIVE DISTRIBUTION OF MTF

SPATIAL FREQUENCY 9 MEAN-3.15538E 00
 NO OF SCANS 100 ST. DEV 3.65596E-01
 TEST DIST LN NORMAL CHI SQ 2.33667E 01
 WAVELENGTH 0.6320 CN 2.790E-8
 OPTICS 0.4572

DATE 92177 TIME 1555

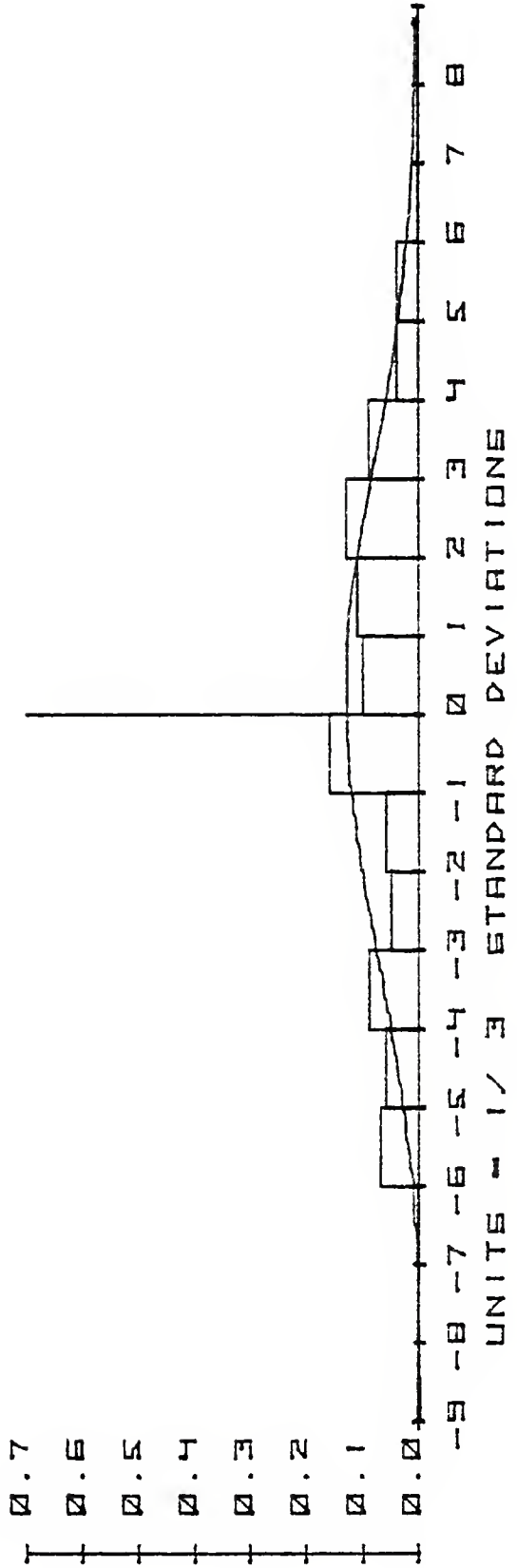

RELATIVE DISTRIBUTION OF MTF

SPATIAL FREQUENCY 11 MEAN-3.26272E 00
 NO OF SCANS 100 ST. DEV 3.77877E-01
 TEST DIST LN NORMAL CHI SQ 1.82347E 01
 WAVELENGTH 0.6328 CN 2.790E-8
 OPTICS 0.4572

DATE 92177 TIME 1555

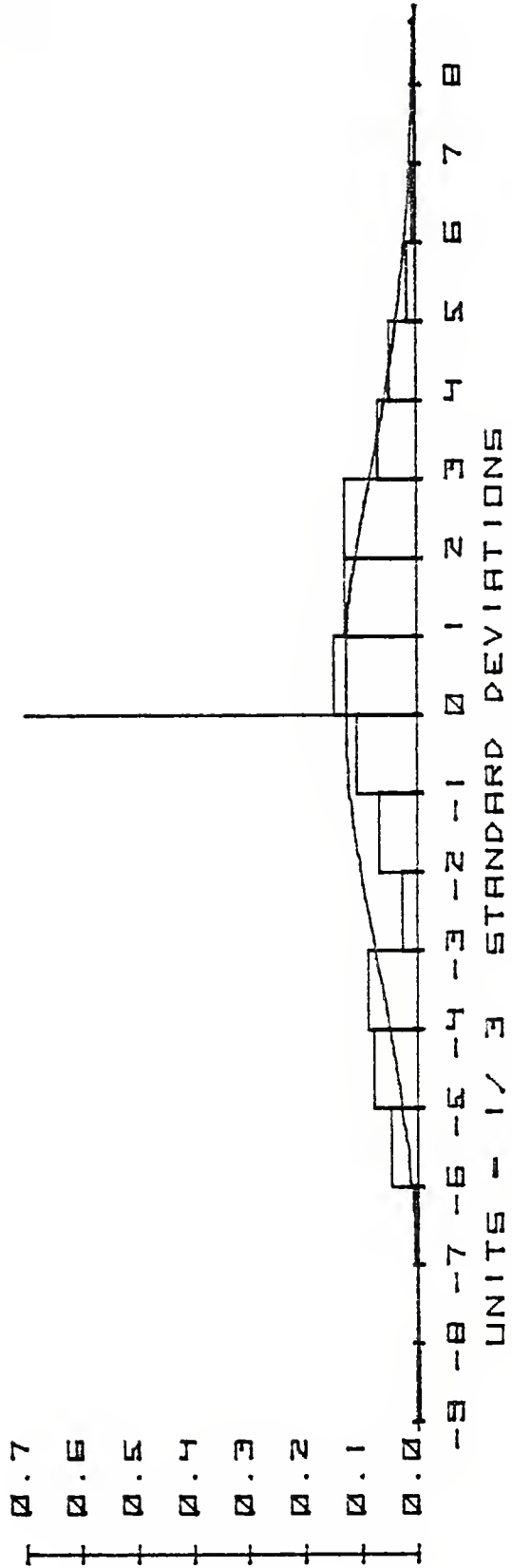

RELATIVE DISTRIBUTION OF MTF

SPATIAL FREQUENCY IS MEAN-3.51679E 00
 NO OF SCANS 100 ST. DEV 4.38113E-01
 TEST DIST LN NORMAL CHI SQ 1.22115E 01
 WAVELENGTH 0.6328 CN 2.790E-8
 OPTICS 0.4572

DATE 92177 TIME 1555

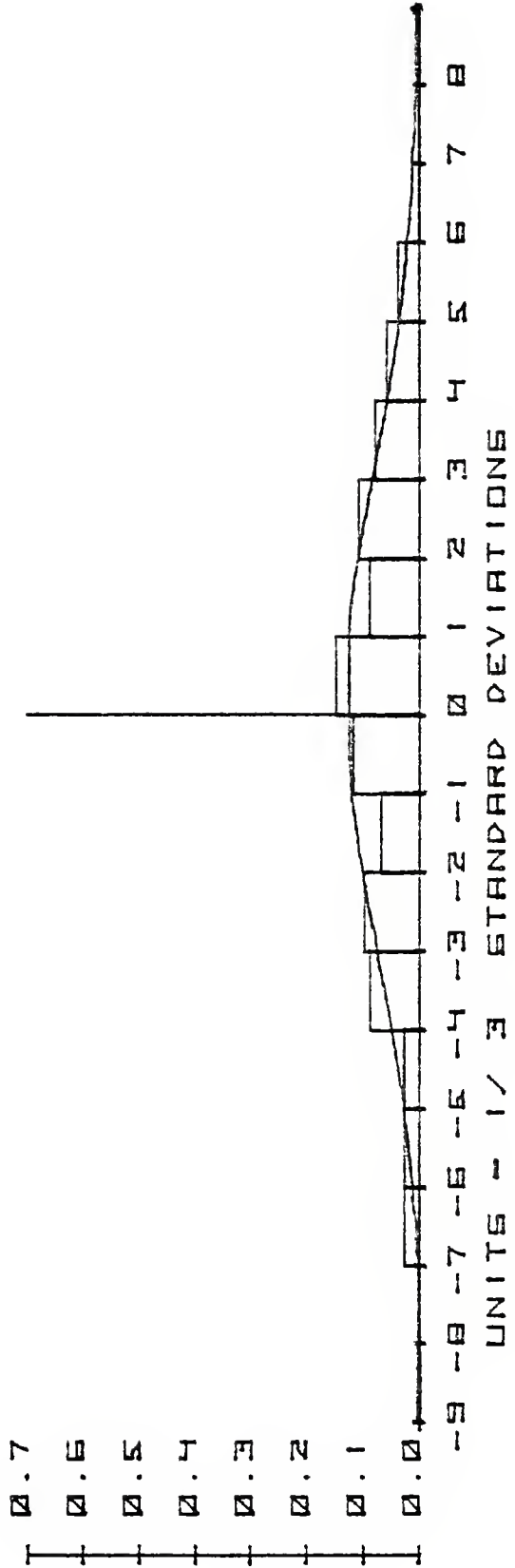

RELATIVE DISTRIBUTION OF MTF

SPATIAL FREQUENCY 19 MEAN-3.76370E 00
 NO OF SCANS 100 ST. DEV 5.09654E-01
 TEST DIST LN NORMAL CHI SQ 2.06506E 01
 WAVELENGTH 0.6328 CN 2.790E-8
 OPTICS 0.4572

DATE 92177 TIME 1555

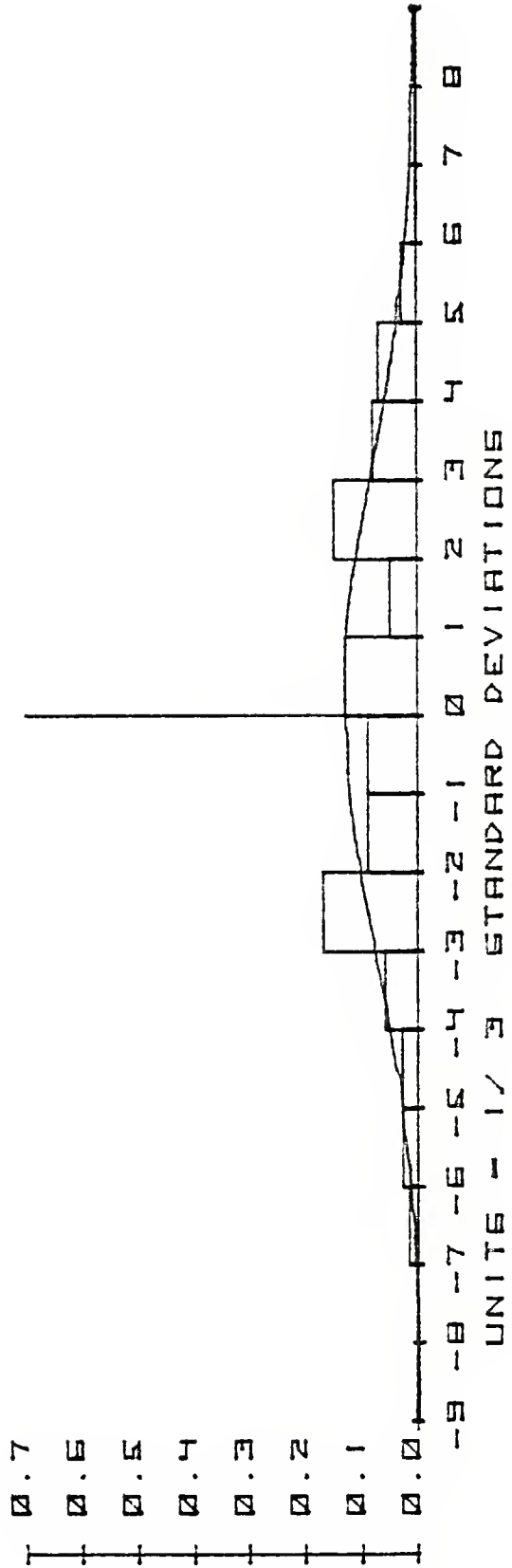

APPENDIX A

Operating Instructions for Data Analysis

A. Initialization

1. NIC-80, Analysis program not loaded

- (a) Turn on computer with key, depress "STOP"
- (b) Turn on Data Bus unit
- (c) Set toggle switches 0 - 11 to up position
- (d) Depress "LOAD PC"
- (e) Depress "CONTINUE"
- (f) Press "EXECUTE"

2. HP-9825

- (a) Turn on HP-9825
- (b) Insert Data Analysis cassette and load track 0,

file 1 for NIC-80 loading program

- (c) Push "RUN"; c, d, i, r, n, o, l, s, t is displayed.
- (d) Push "n" and "CONTINUE"; load file # is displayed.

The NIC-80 data analysis program is located on files 2, 3, 4 and 5. Enter one of these numbers and push "CONTINUE".

(e) Display - c, d, i, r, n, o, l, s, t. Push "1" and continue. The section of the program will be transferred to NIC-80. At the end of each transfer, check sums are printed and should be identical.

(f) Repeat steps (d) and (e) until entire program is transferred. If NIC-80 contained MTF analysis program previously, only files 2 and 3 are necessary to transfer.

(g) On NIC-80, push "STOP", depress "START" and push "EXECUTE" on completion of program loading.

3. Tape Recorder

(a) Turn switch to 3.75 IPS

(b) Switch on DC bias boxes. These should be turned off during non-operating periods to avoid draining batteries.

(c) Set frequency control knob on appropriate channels to FM and 1kc bandpass for signal and trigger. Voice channel requires 37.5 IPS and 100 Kc for operation.

(d) Turn on oscilloscope.

4. Pulse Generator

(a) Turn on power

(b) Set to external trigger pulse.

(c) Set width to 10 microseconds. On tape recorder, depress "DRIVE" and adjust oscilloscope for optimum display.

B. EXECUTION

1. HP-9825

(a) Load track 0, file 8 and push "RUN"

(b) Data entry;

Wavelength, e.g., .6328

Optics, e.g., .4572

Dwelltime, e.g., 95

Number of scans, e.g., 125

Push "CONTINUE" after each entry. On last "CONTINUE" NIC-80 will enter Display/Standby mode. HP-9825 will display "CONTINUE WHEN READY".

2. NIC-80

(a) Verify green control light is on

(b) Adjust CRT for optimum display of scans

(c) Adjust DC level by knobs on bias boxes. Use low resolution on vertical display scale, and adjust signal to center around horizontal scale.

(d) Adjust horizontal position of signal by pulse generator delay knob so as to center around vertical axis.

3. To start data collection, push "CONTINUE" on HP-9825. When all scans are completed, NIC-80 will return to Display/Standby mode and may be taken off-line.

4. Data Analysis (HP-9825 only)

(a) On completion of data collection, "HISTOGRAM AND CONTINUE" is displayed. Check that plotter and printer are ready before pushing "CONTINUE".

(b) Data entry;

Date, e.g., 021577 (month, day, year)

Time, e.g., 1423

Cn arg, e.g., 8.07

Power, e.g., -8

Push "CONTINUE" after each entry.

(c) Unnormalized values for MTF spatial frequencies 0 and 1 are printed for verification of absolute and relative values.

(d) Data entry; "No. of class intervals" is displayed. Enter number of histogram bins per unit standard deviation.

Normally 3. Push "CONTINUE".

(e) Display "FREQ PLOT, YES-1". Push "1" and "CONTINUE" if plot of MTF mean \pm 1 standard deviation for spatial frequency 0 - 19 is required.

(f) Display "LN DATA? YES-1". Enter 1 and push "CONTINUE" if data analysis of normal distribution is completed.

Display "LN ANALYSIS". Push "CONTINUE" if data is to be converted to Ln data.

(g) Display "DATA SUM? YES-1". Enter 1 and push "CONTINUE" if data summary is required.

Display "SUMMARY, CONT.". Push "CONTINUE" to start execution of data summary program.

(h) Display "SPAT FREQ". Enter spatial frequency number (0 - 19) for which histogram will be plotted.

Display "REPLACE PAPER AND CONTINUE". Push "CONTINUE" when plotter is ready.

```

0: if X=1;goto "START"
1: mdec;par 1;fmt 1,fz10.5;enp "wavel",W,"opt",O
2: enp "DWELLTIME",r0,"# OF SCANS",N
3: 20→P;dim F[P],A[P],M[P],S[P],X[P];wrt 2.1,W,O,r0,N;par 0
4: for J=1 to 20;rdb(2)→A;rdb(2)→B;512*B+A→F[J]
5: if F[J]>524287;F[J]-108576→F[J]
6: next J;trk 1
7: enp "CONTINUE WHEN READY",r0
8: wtb 2,r0
9: for I=1 to N;for J=1 to 20;rdb(2)→A;rdb(2)→B;512*B+A→A[J]
10: if A[J]>524287;A[J]-1048576→A[J]
11: rdb(2)→A;rdb(2)→B;512*B+A→r0
12: if r0>524287;r0-1048576→r0
13: A[J]*A[J]+r0*r0→r0;√r0→A[J]
14: A[J]/F[J]→A[J];A[J]*A[J]+S[J]→S[J];M[J]+A[J]→M[J]
15: next J;rcf I,A[*]
16: next I
17: dsp "HISTOGRAM ?,and continue";stp ;flt 5
18: enp "DATE",r99,"TIME",r98,"CN ARG",r94,"POWER",U
19: "PLOT":for Q=1 to 20;trk 1
20: (S[Q]-M[Q]*M[Q]/N)/(N-1)→S[Q];M[Q]/N→M[Q];√S[Q]→S[Q]
21: next Q
22: flt 5;prt "MTF0",M[1],"MTF1",M[2];if r97=1;goto "DS"
23: enp "NO CLASS INTERV",T;beep
24: "START":enp "FREQ PLOT,YES=1",r92;if r92=1;goto "FREPLO"
25: if r97=1;goto "DS"
26: "L":enp "LN DATA?,YES=1",r97;if r97=1;l→Z;goto "LN"
27: "DS":0→X;enp "DATA SUM?,YES=1",X;if X=1;trk 0;ldf 9
28: "PLOT0":enp "SPAT FREQ",A;A+1→Q;trk 1
29: dsp "REPLACE PLOT PAPER AND CONTINUE";beep;stp
30: M[Q]-3*S[Q]→C;M[Q]+3*S[Q]→D
31: S[Q]/T→R;C-2.2*R→r91;csiz 1.6,1.5,1
32: scl C-2*R,D,-.2,1.7;plt D,0,1;plt C-R/10,0,2;fxd 1
33: plt r91+R/2,0,1;plt r91+R/2,.7,2;for I=0 to .7 by .1
34: ltr r91+R/1.5,I;lbl I;plt r91+R/2-R/10,I,1
35: plt r91+R/2+R/10,I,2;next I
36: -3*T→r88;fxd 0
37: for I=C to D by R;plt I,.01,1;plt I,-.01,2
38: ltr I-R/3,-.08;lbl r88
39: r88+1→r88;next I;pen;csiz 1.6,1.5,1
40: ltr C+3*R,1.6;lbl "RELATIVE DISTRIBUTION OF MTF"

```

Figure 8A. Data Analysis Program Listing

```

41: pen;plt M[Q],0;plt M[Q],.7,2
42: ltr C+R,-.15;lbl "UNITS = 1/",T," STANDARD DEVIATIONS"
43: "CURVE":for I=C to D by (D-C)/100;(I-M[Q])/S[Q]→r1
44: r1*r1/2→r1;exp(-r1)*R/(S[Q]*√(2*π))→r2
45: plt I,r2,-2;next I;C→r2;r2-R→r3
46: C→r2;r2+R→r3;flt 5;A→A
47: for K=11 to 11+T*6;0→rK;next K
48: "HIST":for I=1 to N;C→r2;r2+R→r3
49: ldf I,A[*];for K=11 to 11+T*6
50: flt 5;if A[Q]>r2;if A[Q]<r3;rK+1→rK
51: r3→r2;r3+R→r3;next K;next I
52: C→r2;r2+R→r3;for K=11 to 11+T*6;rK→r1
53: r1/N→r1;pen;plt r2,0,-2;plt r2,r1,2;plt r3,r1,2
54: plt r3,0,2
55: (r2-M[Q])/S[Q]→r7;r7*r7/2→r7;exp(-r7)*R/(S[Q]*√(2*π))→r4
56: (r3-M[Q])/S[Q]→r7;r7*r7/2→r7;exp(-r7)*R/(S[Q]*√(2*π))→r5
57: R*r4+abs(r5-r4)/2→r8;r8/R→r8
58: (N*r8-r1*N)^2/(N*r8)→r9;r9+r10→r10
59: r3→r2;r3+R→r3;next K
60: "LABEL":C+R/3→r1;fxd 0;ltr r1,1.45
61: lbl "SPATIAL FREQUENCY",Q-1
62: if r97=1;ltr r1,1.25;lbl "TEST DIST LN NORMAL";gto +2
63: ltr r1,1.25;lbl "TEST DIST NORMAL"
64: ltr r1,1.35;lbl "NO OF SCANS",N
65: fxd 4;ltr r1,1.15;lbl "WAVELENGTH",W;ltr r1,1.05
66: lbl "OPTICS",O
67: fxd 0;ltr r1,.9;lbl "DATE",r99," TIME",r98;flt 5
68: M[Q]+R/3→r1;ltr r1,1.35;lbl "St. dev",S[Q]
69: ltr r1,1.45;lbl "MEAN",M[Q]
70: ltr r1,1.25;lbl "CHI SQ",r10;ltr r1,1.15;fxd 3
71: lbl "CN",r94;fxd 0
72: lbl "E",U
73: for I=1 to 90;0→rI;next I
74: if r97=1;gto "DS"
75: gto "L"
76: "LN":dsp "LN ANALYSIS";stp ;trk 1
77: for J=1 to 20;0→M[J]→S[J];next J
78: for I=1 to N
79: ldf I,A[*];for J=1 to 20;if A[J]=0;if J=20;gto +5
80: if A[J]=0;next J

```

Figure 8B. Data Analysis Program Listing

```

81: ln(A[J])→A[J]
82: A[J]*A[J]+S[J]→S[J];M[J]+A[J]→M[J]
83: next J;rcf I,A[*]
84: next I;gto "PLOT"
85: "FREPLO":scl -3,20,-.25,1.5;fxd 0;csiz 1.6,1.5,1
86: plt 20,0,1;plt 0,0,2;plt -1.85,0,1;plt -1.85,1,2
87: for I=1 to 20;plt I-1,.01,1;plt I-1,-.01,2;next I
88: for I=1 to 20 by 5;I-1→r95;ltr r95-.3,-.05;lbl r95
89: next I;fxd 1
90: for I=0 to 1 by .1;ltr -1.85,I;lbl I;plt -1.9,I,1
91: for I=0 to 1 by .1;ltr -1.85,I;lbl I;plt -1.9,I,1
92: plt -1.8,I,2;next I
93: ltr 2,-.19;lbl "SPATIAL FREQUENCY IN 1/ MILLIRADIANS"
94: ltr 2,1.45;lbl "MTF MEAN AND + - 1 STANDARD DEVIATION"
95: fxd 0;ltr 2,1.35
96: lbl "DATE",r99," TIME",r98," NO OF SCANS",N
97: fxd 4;ltr 5,1.25;lbl "WAVELENGTH",W," OPTICS",O
98: flt 5;ltr 5,1.15;fxd 3;lbl "CN",r94;fxd 0;lbl "E",U
99: M[1]→r93
100: csiz 3,1,1,90;ltr -2.1,.4;lbl "MTF"
101: for Q=1 to 20;50+Q→r48;70+Q→r49;M[Q]/r93→r48
102: S[Q]/r93→r49
103: plt Q-1,r48-r49,1;plt Q-1,r48+r49,2
104: plt Q-1.05,r48,1;plt Q-.95,r48,2;pen;next Q;gto "L"

```

Figure 8C. Data Analysis Program Listing

```

0: dsp "SUMMARY,CONT";beep;stp
1: "X":for Q=1 to 20
2: S[Q]/T→R
3: A[Q]-3*S[Q]→C;M[Q]+3*S[Q]→D
4: for K=11 to 11+T*6;0→rK;next K
5: "HIST":for I=1 to N;C→r2;r2+R→r3
6: trk 1
7: ldf I,A[*];for K=11 to 11+T*6
8: flt 5;if A[Q]>r2;if A[Q]<r3;rK+1→rK
9: r3→r2;r3+R→r3;next K;next I
10: C→r2;r2+R→r3;for K=11 to 11+T*6;rK→r1
11: r1/N→r1
12: (r2-M[Q])/S[Q]→r7;r7*r7/2→r7;exp(-r7)*R/(S[Q]*√(2*π))→r4
13: (r3-M[Q])/S[Q]→r7;r7*r7/2→r7;exp(-r7)*R/(S[Q]*√(2*π))→r5
14: R*r4+abs(r5-r4)/2*R→r8;r8/R→r8
15: (N*r8-r1*N)^2/(N*r8)→r9;r9+r10→r10
16: r3→r2;r3+R→r3;next K;r10→X[Q];0→r10;next Q;gto "PRINT"
17: "PRINT":fmt 2,25x,"DATE",2x,f6.0,2x,"TIME",2x,f4.0
18: fmt 1,25x,"Cn",2x,f5.3,2x,"E",f3.0,2x,"OPTICS",2x,f6.4,2x
19: fmt 3,35x,"DATA SUMMARY"
20: if Z=1;gto "L1"
21: wrt 6.3,13
22: wtb 6,10,10
23: wrt 6.2,r99,r98
24: wtb 6,10,10
25: wrt 6.1,r94,U,0
26: wtb 6,10,10
27: fmt 4,25x,"TEST DIST.NORMAL",26x,"TEST DIST LN NORMAL"
28: wrt 6.4
29: wtb 6,10,10
30: fmt 5,15x,"SPAT FR",5x,"MEAN",11x,"ST.DEV",10x,"CHI SQ",10x,"CHI
31: wrt 6.5;wtb 6,10,10
32: fmt 6,15x,f2.0,6x,e11.5,5x,e11.5,5x,e11.5
33: for I=1 to 20;wrt 6.6,I-1,M[I],S[I],X[I];next I
34: for I=1 to 20;wtb 6,27,10;next I
35: fmt 7,72x,e11.5
36: if Z=1;gto "L1"
37: trk 0;ldf 8
38: "L1":fmt 7,72x,e11.5
39: for I=1 to 20;wrt 6.7,X[I];next I
40: trk 0;ldf 8

```

Figure 9. Data Summary Program Listing

```

0      110600  MEMA(600 /READOUT LIGHTS
1      4304   LCWORD /CONTROL WORD
2      44034  STU /READ STATUS
3      10377  ANDA(377 /COMPARE SETTINGS
4      462340 A-MZ(340 /CHECK HARD SETTING
5      0      JMP 0 /RETURN CHECK LOOP
6      2175677 ZERMA 1677 /0 TO ACC & 1677
7      4304   LCW(0 /LOAD CONTROL WORD
10     3001737 JMS@INP /INPUT
11     3001745 JMS@1745 /PUTAC
12     1616   1616 /ADR OF WAVELENGTH
13     3001737 JMS@INP /INPUT
14     3001745 JMS@1745 /PUTAC
15     1614   1614 /ADR OF OPTICS
16     3001737 JMS@INP /INPUT
17     3001745 JMS@1745 /PUTAC
20     1600   1600 /ADR OF DWELLTIME
21     3001737 JMS@INP /INPUT
22     3001745 JMS@1745 /PUTAC
23     1620   1620 /ADR NO OF SCANS
24     110020 MEMA(20 /COUNT VALUE
25     2405677 ACCM 1677 /COUNT INDEX
26     2001500 JMS 1500 /CAL ADDRESS
27     3111576 MEMA@1576 /CAL VALUE
30     10777  ANDA(777 /9 BITS
31     6474   HSP /IS HP 9825 READY
32     31     JMP 31 /WAIT LOOP
33     4473   PHS /WRITE TO HP 9825
34     3111576 MEMA@1576 /CAL VAL RECALLED
35     405031 RIS 11 /RIGHT SHIFT
36     6474   HSP /IS HP 9825 READY
37     36     JMP 36 /WAIT LOOP
40     4473   PHS /WRITE REMAINING DATA
41     2125576 MPOM 1576 /INCR. CAL ADDRESS
42     2703677 MMOZ 1677 /DECR.&TEST
43     27     JMP 27 /RETURN LOOP
44     3001742 JMS@1742 /GETAC
45     1600   1600 /ADR. OF DWELLTIME
46     3001715 JMS@1715 /FIX

```

Figure 10A. Nic 80 Program Listing

```

47 3111722 MEMA@1722 /FACM
50 4311 LDWELL /LOAD DWELL TIME
51 110000 MEMA(0 /0 TO ACC
52 4312 LDELAY /LOAD DELAY TIME
53 2111711 MEMA 1711 /STAND BY LOOP
54 4304 LCWORD /LOAD CONTROL WORD
55 4302 SET /SET MEASURE FF
56 5220 STOP /READ 1 SCAN
57 6464 HSRF /SKIP ON HP REQUEST
60 53 JMP 53 /RETURN STAND BY LOOP
61 44463 RHSR /READ HP
62 462314 A-MZ(314 /L FOR FUTURE BRANCH
63 64 JMP 64 /FUTURE BR.ADR.
64 3001723 JMS@1723 /SHORT TERM RESET
65 2111704 MEMA 1704 /B4(0)
66 2405677 ACCM 1677 /
67 2111626 MEMA 1626 /# OF SCANS
70 2405672 ACCM 1672 /
71 2111712 MEMA 1712 /CONTROL WORD #2
72 4304 LCWORD /LOAD CONT.WORD
73 4302 SETM /SET MEASURE FF
74 5220 STOP /READ 1 SCAN
75 100 JMP 100 /
76 0 0 /NOT USED
77 0 0 /NOT USED
100 110200 MEMA(200 /
101 4304 LCWORD /DISPLAY CONTROL
102 2111700 MEMA 1700 /B0(0),LEFT END
103 2405677 ACCM 1677 /
104 2711701 MMOA 1701 /B0(1777),RIGHT END
105 2405676 ACCM 1676 /
106 110040 MEMA(40 /32 POINTS
107 2405675 ACCM 1675 /
110 2165674 ZERM 1674 /
111 3111677 MEMA@1677 /INTEGRAL BASE LINE
112 2505674 A+MM 1674 /
113 3111676 MEMA@1676 /
114 2505674 A+MM 1674 /

```

Figure 10B. Nic 80 Program Listing

```

115 2125677 MPOM 1677 /
116 2705676 MMOM 1676 /
117 2707675 MMOMZ 1675 /
120 111 JMP 111 /
121 2111674 MEMA 1674 /
122 5026 RASH6 /DIVIDE BY 6
123 2405674 ACCM 1674 /AVERAGE DC COMPONENT
124 2111700 MEMA 1700 /B0(0)
125 2405677 ACCM 1677 /
126 3111677 MEMA@1677 /
127 2471674 A-MA 1674 /SUBTRACTING
130 3405677 ACCM@1677 /
131 2135677 MPCMA 1677 /
132 2463701 A-MZ 1701 /
133 126 JMP 126 /RETURN ADR.LOOP
134 110002 MEMA(2
135 3001722 JMS@1722 /MOVE B0→B2
136 2111703 MEMA 1703 /B3 ZERO LOOP
137 2405677 ACCM 1677 /
140 2111700 MEMA 1700 /B0
141 2405676 ACCM 1676 /
142 3165676 ZERM@1676 /
143 3165677 ZERM@1677 /
144 2125677 MPOM 1677 /
145 2135676 MPCMA 1676 /
146 2463701 A-MZ 1701 /
147 142 JMP 142 /RETURN ADR.LOOP
150 3001776 JMS@1776 /
151 3001622 JMS@1622 /DFT DATA TRANSFER
152 4032 ASCNTR /ADVANCE SWEEP COUNTER
153 2703626 MMOZ 1626 /DECREASE SCAN COUNT
154 71 JMP 71 /RETURN ADR.NEXT SCAN
155 53 JMP 53 /RETURN ADR.STAND BY L.

```

Figure 10C. Nic 80 Program Listing

```

3445      152      152 /RETURN ADDRESS
3446      110024   MEMA(24 /# OF SPAT.FR.
3447      2405675 ACCM 1675 /CONTING INDEX
3450      2111702 MEMA 1702 /B2, REALS
3451      2405677 ACCM 1677 /CURRENT B2
3452      2111703 MEMA 1703 /B3, IMAGINARIES
3453      2405676 ACCM 1676 /CURRENT B3
3454      3111677 MEMA@1677 /VALUE B2
3455      10777    ANDA(777 /9 BITS
3456      6474     HSP /HP READY
3457      1456     JMP 1456 /WAIT LOOP
3460      4473     PHS /WRITE TO HP
3461      3111677 MEMA@1677 /RECALL B2
3462      405031   RIS 11 /RIGHT SHIFT
3463      6474     HSP /
3464      1463     JMP 1463 /
3465      4473     PHS /
3466      3111676 MEMA@1676 /
3467      10777    ANDA(777 /
3470      6474     HSP /
3471      1470     JMP 1470 /
3472      4473     PHS /
3473      3111676 MEMA@1676 /
3474      405031   RIS 11 /
3475      6474     HSP /
3476      1475     JMP 1475 /
3477      4473     PHS /
3500      2125677 MPOM 1677 /INCREASE B2
3501      2125676 MPOM 1676 /INCREASE B3
3502      2707675 MMOMZ 1675 /DECREASE & TEST
3503      1454     1454 /RETURN ADR.
3504      1001445 JMP@1445 /RETURN TO MAIN PR.

```

Figure 10D. Nic 80 Program Listing

LIST OF REFERENCES

1. Naval Postgraduate School, Optical Resolution in the Turbulent Atmosphere of the Marine Boundary Layer, E.C. Crittenden, Jr. et. al, February, 1978.
2. Cole, O. R., Shipboard Measurements of Laser Beam Scintillation in the Marine Boundary Layer. M.S. Thesis, United States Naval Postgraduate School, Monterey, California, 1974.
3. Barnes, E. T., Procedures for Simplified Recording and Data Reduction of the Modulation Transfer Function of the Atmosphere. M.S. Thesis, United States Naval Postgraduate School, Monterey, California, 1974.

INITIAL DISTRIBUTION LIST

	No. Copies
1. Defense Documentation Center Cameron Station Alexandria, Virginia 22314	2
2. Library, Code 0142 Naval Postgraduate School Monterey, California 93940	2
3. Professor K. K. Woehler Code 61Wh Department of Physics and Chemistry Naval Postgraduate School Monterey, California 93940	2
4. Assoc. Professor E. A. Milne (thesis advisor) Code 61Mn Department of Physics and Chemistry Naval Postgraduate School Monterey, California 93940	6
5. Dr. David Land Code WR41 Naval Surface Weapon Center White Oak, Silver Spring, Maryland 20910	1
6. LCDR R. A. Molland 24th FPB Squadron 5078 Haakonsværn Norway	2

180199

Thesis
M66835
c.1

Molland

Procedure for statistical analysis of single scan modulation transfer functions for optical transmission in the marine boundary atmosphere.

Thesis
M66835
c.1

Molland

180199

Procedure for statistical analysis of single scan modulation transfer functions for optical transmission in the marine boundary atmosphere.

thesM66835

Procedure for statistical analysis of si



3 2768 002 04675 7

DUDLEY KNOX LIBRARY C.1