



**Calhoun: The NPS Institutional Archive**  
**DSpace Repository**

---

NPS Scholarship

Theses

---

2002-06

## A rolling line source for a seismic sonar

McClelland, Scott C.

Monterey, California. Naval Postgraduate School

---

<https://hdl.handle.net/10945/5874>

---

This publication is a work of the U.S. Government as defined in Title 17, United States Code, Section 101. Copyright protection is not available for this work in the United States.

*Downloaded from NPS Archive: Calhoun*



Calhoun is the Naval Postgraduate School's public access digital repository for research materials and institutional publications created by the NPS community. Calhoun is named for Professor of Mathematics Guy K. Calhoun, NPS's first appointed -- and published -- scholarly author.

**Dudley Knox Library / Naval Postgraduate School**  
**411 Dyer Road / 1 University Circle**  
**Monterey, California USA 93943**

<http://www.nps.edu/library>

**NAVAL POSTGRADUATE SCHOOL  
Monterey, California**



**THESIS**

**A ROLLING LINE SOURCE FOR A SEISMIC SONAR**

by

Scott C. McClelland

June 2002

Thesis Co-Advisor:                      Steven R. Baker  
Co-Advisor:                                Thomas G. Muir

**Approved for public release; distribution is unlimited**

THIS PAGE INTENTIONALLY LEFT BLANK

<b>REPORT DOCUMENTATION PAGE</b>			Form Approved OMB No. 0704-0188		
Public reporting burden for this collection of information is estimated to average 1 hour per response, including the time for reviewing instruction, searching existing data sources, gathering and maintaining the data needed, and completing and reviewing the collection of information. Send comments regarding this burden estimate or any other aspect of this collection of information, including suggestions for reducing this burden, to Washington headquarters Services, Directorate for Information Operations and Reports, 1215 Jefferson Davis Highway, Suite 1204, Arlington, VA 22202-4302, and to the Office of Management and Budget, Paperwork Reduction Project (0704-0188) Washington DC 20503.					
1. AGENCY USE ONLY (Leave blank)		2. REPORT DATE June 2002		3. REPORT TYPE AND DATES COVERED Master's Thesis	
4. TITLE AND SUBTITLE A ROLLING LINE SOURCE FOR A SEISMIC SONAR			5. FUNDING NUMBERS		
6. AUTHOR (S) Scott McClelland					
7. PERFORMING ORGANIZATION NAME(S) AND ADDRESS(ES) Naval Postgraduate School Monterey, CA 93943-5000			8. PERFORMING ORGANIZATION REPORT NUMBER		
9. SPONSORING / MONITORING AGENCY NAME(S) AND ADDRESS(ES)			10. SPONSORING/MONITORING AGENCY REPORT NUMBER		
11. SUPPLEMENTARY NOTES The views expressed in this thesis are those of the author and do not reflect the official policy or position of the U.S. Department of Defense or the U.S. Government.					
12a. DISTRIBUTION / AVAILABILITY STATEMENT Approved for public release; distribution is unlimited			12b. DISTRIBUTION CODE		
13. ABSTRACT (maximum 200 words) This thesis builds on ideas of a seismo-acoustic sonar as a mine detection tool and is part of an ongoing Naval Postgraduate School (NPS) research project. Building on this foundation of research, a source was developed to enable mobility. The previous NPS array [Sheetz] design employed an array of sources, buried in the sediment in a line. This arrangement is somewhat cumbersome for direct application. A practical device should be mobile and create a high source signal similar to the previous NPS array. A rolling cylinder provided the solution. The cylinder houses two shakers, identical to the previous NPS array elements, mounted directly to the cylinder wall. The source for a single buried array element, from the previous NPS array, and a single rolling cylinder, placed on the surface, were shown to provide similar seismic velocity at ten meters range. Using this rolling source, we measured wave speed at 83 m/s by signal correlation methods. Employing two rolling cylinder sources against a buried 1000 lb bomb at five meters range resulted in echo detection with only internal signal analyzer algorithms. The ability to send and receive signals on the go was proven to be attainable with a rolling line source.					
14. SUBJECT TERMS seismic sonar			15. NUMBER OF PAGES 84		
17. SECURITY CLASSIFICATION OF REPORT Unclassified			18. SECURITY CLASSIFICATION OF THIS PAGE Unclassified	19. SECURITY CLASSIFICATION OF ABSTRACT Unclassified	20. LIMITATION OF ABSTRACT UL

NSN 7540-01-280-5500

Standard Form 298 (Rev. 2-89)  
Prescribed by ANSI Std. Z39-18

THIS PAGE INTENTIONALLY LEFT BLANK

Approved for public release; distribution is unlimited

**A ROLLING LINE SOURCE FOR A SEISMIC SONAR**

Scott McClelland  
Lieutenant, United States Naval Reserve  
B.A., Governors State University, 2000

Submitted in partial fulfillment of the  
requirements for the degree of

**MASTER OF SCIENCE IN PHYSICS**

from the

**NAVAL POSTGRADUATE SCHOOL  
June 2002**

Author: Scott C. McClelland

Approved by: Steven R. Baker  
Co-Advisor

Thomas G. Muir  
Co-Advisor

William B. Maier, II  
Chairman, Department of Physics

THIS PAGE INTENTIONALLY LEFT BLANK

## **ABSTRACT**

This thesis builds on ideas of a seismo-acoustic sonar as a mine detection tool and is part of an ongoing Naval Postgraduate School (NPS) research project. Building on this foundation of research, a source was developed to enable mobility. The previous NPS array [Sheetz] design employed an array of sources, buried in the sediment in a line. This arrangement is somewhat cumbersome for direct application. A practical device should be mobile and create a high source signal similar to the previous NPS array. A rolling cylinder provided the solution. The cylinder houses two shakers, identical to the previous NPS array elements, mounted directly to the cylinder wall. The source for a single buried array element, from the previous NPS array, and a single rolling cylinder, placed on the surface, were shown to provide similar seismic velocity at ten meters range. Using this rolling source, we measured wave speed at 83 m/s by signal correlation methods. Employing two rolling cylinder sources against a buried 1000 lb bomb at five meters range resulted in echo detection with only internal signal analyzer algorithms. The ability to send and receive signals on the go was proven to be attainable with a rolling line source.



THIS PAGE INTENTIONALLY LEFT BLANK

## TABLE OF CONTENTS

I.	INTRODUCTION .....	1
A.	SEISMIC SONAR CONCEPT .....	6
B.	ROLLING LINE SEISMIC SOURCE .....	8
II.	ROLLING LINE SEISMIC SOURCE .....	11
A.	SHAKER ASSEMBLY .....	11
B.	FORCE .....	14
C.	GEOPHONE AND SEISMOMETER INSTRUMENT .....	22
D.	LABORATORY TANK TEST .....	24
III.	FIELD TESTING .....	29
A.	FIVE SOURCES USED IN COMPARATIVE TESTING .....	30
A.	FIVE SOURCES USED IN COMPARATIVE TESTING .....	31
B.	SIGNAL COMPONENTS MEASURED AT 12.2 M (40 FT) RANGE .....	33
C.	SIGNAL CORRELATION DOWN RANGE .....	37
D.	WAVE SPEED .....	38
IV.	TARGET ECHO-LOCATION EXPERIMENT .....	41
A.	1000 LB. BOMB TARGET .....	43
V.	CONCLUSION AND RECOMMENDATIONS .....	49
	APPENDIX A. SM-11 GEOPHONE .....	53
	APPENDIX B. MANUFACTURER SPECIFICATION OF AURA BASS SHAKER ..	55
	APPENDIX C. FORCE SENSOR DOCUMENTATION .....	57
	APPENDIX D. PROFESSOR JAMES SABATIER MINE HUNTING METHOD ....	61
	LIST OF REFERENCES .....	63
	INITIAL DISTRIBUTION LIST .....	67

THIS PAGE INTENTIONALLY LEFT BLANK

## LIST OF FIGURES

Figure 1.	Illustration of Rayleigh wave Echo-Location.....	6
Figure 2.	Rolling Line Source Element.....	9
Figure 3.	Magnetic Slug mounted together on a plywood board.....	11
Figure 4.	Shaker assembly mounted in tube.....	12
Figure 5.	Two element rolling line source.....	14
Figure 6.	Force gauge measurement setup.....	16
Figure 7.	Block diagram of force sensor electronics.....	17
Figure 8.	Force sensor reading for first positive peak (100hz single cycle signal at 0.28 Vpp).....	18
Figure 9.	Tube Assembly and Force gauge.....	20
Figure 10.	Force measurements with tube and bare shaker assembly.....	21
Figure 11.	Basic Geophone construction.....	22
Figure 12.	SM-11 geophones mounted on three axes.....	23
Figure 13.	Tube and Seismometer.....	25
Figure 14.	Electronic setup for tank test of rolling line source.....	26
Figure 15.	Seismometer vertical response in tank 1 meter from source with an input signal of a single sine wave at 100 Hz.....	27
Figure 16.	Force sensor with Shaker mounted to the tube for a single cycle 100 Hz sine wave.....	28
Figure 17.	Field testing electronics setup.....	30
Figure 18.	Five source beach deployment.....	31
Figure 19.	Photo of the Five Sources.....	32
Figure 20.	Photo of buried seismometer at 12.2 m (40ft)....	33
Figure 21.	Radial and vertical time series data for all five sources.....	34
Figure 22.	Vertical component received signal from the rolling line and buried paddle source at a range of 12.2 m (40ft).....	35
Figure 23.	Radial component received signals from the rolling line and buried paddle source at a range of 12.2 m (40ft).....	36
Figure 24.	Beach setup for cross correlation.....	37
Figure 25.	Correlation measurement of vertical down range signal at 43.6 m (143ft).....	38
Figure 26.	Time record of two seismometers separated by 43.6 m (143ft).....	39
Figure 27.	Seismometer array and tube surface sources.....	41
Figure 28.	Electronic setup for Target Echo-Location.....	42

Figure 29.	Inert 1000 lb. bomb being buried in the sand of the Navy beach on Monterey Bay.....	43
Figure 30.	1,000 lb. bomb experiment with rolling line sources.....	44
Figure 31.	Radial Auto-Correlation for bomb.....	45
Figure 32.	Radial Auto Correlation record without bomb.....	46
Figure 33.	Radial time signal for 1,000 lb. bomb, together with a time trace with no target.....	47

## LIST OF TABLES

Table 1. Seismic Interface wave speed on Monterey Beach . . . .	40
---	----

THIS PAGE INTENTIONALLY LEFT BLANK

## ACKNOWLEDGEMENTS

The author wishes to express sincere appreciation to Professors Steve Baker and Thomas Muir for their direct guidance and for encouraging me to think outside the box. They allowed me to pursue ideas, which are fundamental to physics and to use their experience in experimental design. Without being able to "dip into their toolbox" of experience, this project would not have been successful. I also thank my family. They are an inspiration to me. My wife, Sonja, who stands by trying to understand, but keeps me down to earth and my children, Skyler and Stormie, whose curiosity in physics has pushed me to study it, and try to understand as much as I possibly can. This work was supported by the U.S. Navy Office of Naval Research, Codes 322 and 3210A, Drs. Edward Estalote, Jeffery Simmen, and Douglas Todoroff, program managers.



THIS PAGE INTENTIONALLY LEFT BLANK

## I. INTRODUCTION

This thesis documents the development and testing of a rolling line seismic source for detection of objects buried in the surf zone.

Buried mines are a major threat to landing troops on beachheads, which can prevent the projection of naval power ashore. To address the buried mine threat, a new "seismic sonar" concept, one that employs guided seismo-acoustic surface waves, has been the subject of research and development at Naval Postgraduate School (NPS) and elsewhere. Seismo-acoustic surface waves exist at the boundary of an elastic half-space and a fluid, such as occurs at the surf- and near surf- zone, penetrating only about one propagation wavelength into the elastic half-space (the Earth). By virtue of their localization to the volume near the boundary, these waves have two particular advantages over body waves (elastic waves in an unbounded medium), for echolocating objects buried near the Earth's surface. First, by choice of operating frequency, the volume of ensonification below the Earth's surface can be restricted to that which is likely to contain buried mines, and avoid ensonifying deeper, strongly reflecting features, such as the sediment-basement interface, and so reducing false alarms. Second, they suffer only cylindrical spreading, versus the spherical spreading that would a body wave, and so the transmission loss of wave energy, both to and from the target, due to geometrical spreading, which is the major loss at the close ranges a mine detection sonar

system would operate, would be half that (in terms of dBs) of a sonar employing body waves.

There are two types of seismic sonar, passive and active. The passive seismic sonar came first. Some 22 years ago (1980), Schmalfeld and Rauch [Ref. 3], at the Laboratory of the Supreme Allied Commander, Atlantic (SACLANTCEN), the North Atlantic Treaty Organization (NATO) Anti Submarine Warfare (ASW) Center, in La Spezia Italy, demonstrated, for the first time, the passive seismic sonar. Working in the shallow waters of the Ligurian area of the Mediterranean Sea, off Viareggio, with a tri-axial, ocean bottom seismometer, and paying close attention to the signal processing of the horizontal (x and y) geophones in the seismometer, they were able to track the shaft rotation, and hence the propeller blade lines, of a passing merchant ship, with the "figure eight" beam pattern of a single seismometer.

The first feasible active seismic sonar came much later, some 6 years ago (1996) in response to another important naval problem. Muir, Smith, and Wilson [Refs. 7-9] showed that an elliptically polarized shear wave, known as a Rayleigh interface wave, with significant signal processing, provides sufficient backscattered echoes to locate objects buried under the sediment surface. Recent work [Refs. 7-18,22] shows that array configurations of vibratory seismic sources and 3 axis seismometer receivers produces narrow beam patterns. Bi-static configurations for target detection have also been demonstrated.

Sound waves in water were first used for bottom sounding and echolocation in the early 20<sup>th</sup> century by the French scientist Paul Langevin, a friend of the famous chemist Madam Marie Curie. Now acoustic sonars are well developed, and are an integral part of every warship, worldwide.

Seismic interface waves, such as Rayleigh waves, are considerably more complicated. Theoretically, they are the result of solutions of the elastic wave equations, appropriate for the boundary conditions at hand. The wave velocity of an interface wave is approximately 90% of the bulk shear velocity in the soil or sedimentary medium. Rayleigh waves have two components, rather than just one for sound wave. The boundary conditions appropriate for air overlying a solid (such as soil or sediment), cause a Rayleigh wave to propagate along the air-solid interface, decaying exponentially in both media, along with cylindrical ( $1/\sqrt{R}$ ) spreading with range  $R$ , plus some absorption. Of the two components, one is in the vertical plane, the other in the horizontal plane, oriented radially, along the direction of propagation. The two components combine to produce particle motion in the form of elliptical orbits in a vertical plane oriented along the path of the actual wave. Near the surface, the Rayleigh wave has a retrograde (counterclockwise) orbit, while at a depth of, typically 0.1 to 0.2 wavelengths, depending on the Poisson ratio of the soil or sediment, the particle velocity becomes prograde (clockwise).

There is a 90 degree phase shift between the vertical and horizontal components, which prompted Smith [Ref. 10] to pioneer a signal processing method called "vector polarization filtering," that capitalizes on this phase relationship. Almost every subsequent study on this subject has utilized this technique. It typically provides some 10 to 15 dB of processing gain against acoustic wave noise, background seismic noise (waves crashing on the beach) and most importantly, seismic reverberation in the sonar beam. This is a significant achievement, since a 10 dB improvement for reverberation limited, cylindrically spreading sonar increases the range of the sonar by a factor of 10. Since the received signals are already there, it would be foolish to not process them by this or some other method, to gain the advantage of increased detection range, which translates into increased real search rate, increased speed of sonar survey, etc.

Many textbook authors, who probably have been cloistered in indoor offices doing theory, incorrectly state that the Rayleigh wave is non dispersive. While this might be true for a computer chip that is homogenous with uniform velocity in all directions, it is not true for the earth's crust, which is not homogeneous, and has an increasing shear velocity with depth, due to 1) the overburden load that compacts the soil or sediment, increasing its shear velocity with depth, 2) the presence of rock strata that are also compressed and have significantly increased shear velocity. The dispersion is

most pronounced at the frequencies below 20 Hz, because the longer wavelength seismic waves have deeper penetration, and so tend to propagate in faster layers or strata. Thus, the low frequency components of a Rayleigh wave are first to arrive at the field point, where a seismometer might be located.

Finally, there are two Rayleigh waves, even at the surface: one the classical retrograde Rayleigh wave that we have been discussing, the other, which is prograde and goes by the name "pseudo Rayleigh wave" or "leaky" Rayleigh wave." The latter wave has been "dismissed" by authors for hundreds of years, because it is fairly highly attenuated, and has been thought to be unimportant. This is certainly the case for an earthquake, where the Rayleigh waves do most of the damage, but it may not be true in buried mine hunting, which is a relatively short-range operation. Scholars, such as the student's second reader of this thesis, are studying Lord Rayleigh's original paper, 1885 [Ref. 1], to try to sort out what subsequent authors have missed or altered.

Dispersion can also occur at higher frequencies, due to the waves encountering areas of different geological properties, and to interference between the Rayleigh wave and the pseudo Rayleigh wave.

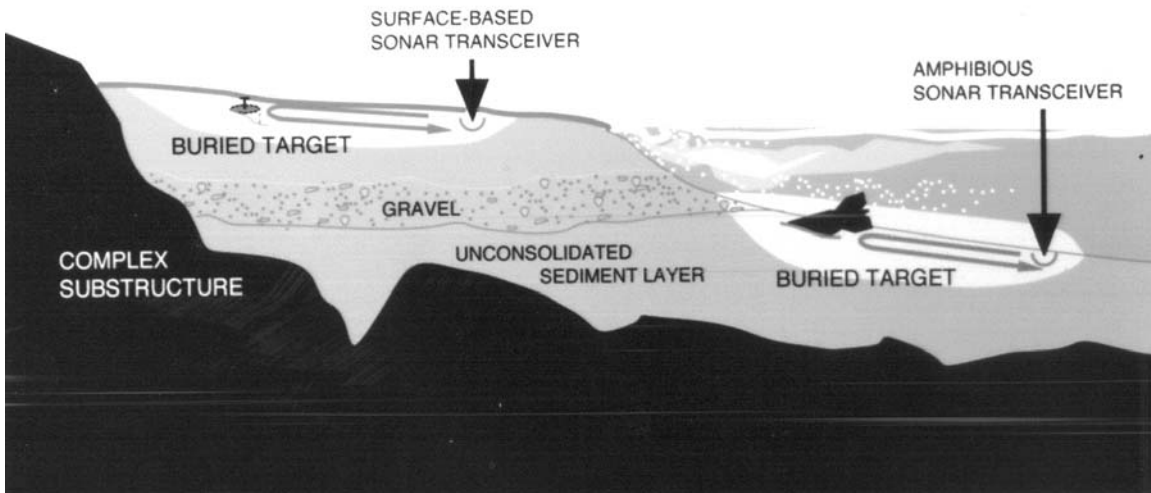

Figure 1. Illustration of Rayleigh wave Echo-Location

**A. SEISMIC SONAR CONCEPT**

The concept illustrated in Figure 1, seismic sonar for mine detection, began in 1996 at the Applied Research Laboratories of the University of Texas at Austin. Since its inception, research has focused on exploiting the guided surface wave to detect buried mines. Three major areas of research cover 1) the source, 2) the receiver, and 3) signal processing. Previous thesis students at the Naval Postgraduate School have focused on source development, target strength, and signal processing [Refs. 14-18]. Another prominent research project, under development, by Professor James Sabatier [Refs.19, 20] of the University of Mississippi uses a loudspeaker in air as a source and a scanning laser as a receiver. A brief description of this method is given in Appendix D.

Source development has gone through many variations. The first NPS device [Gaghan] consisted of a pair of orthogonally-mounted inertial shakers attached to a base plate with screws extending into the sediment, so the flat base plate and screws would exert forces against the earth to create the surface wave. Another style [Fitzpatrick] took advantage of a linear actuator with a flat plate mounted to the shaft end that was buried in the sediment. Typically, the shaft was oriented vertically, so as to couple to the vertical component of the Rayleigh wave. The next source [Sheetz] was a buried shaker, which was designed to couple better to the Earth, and so to better excite the Rayleigh wave. It was also used to excite horizontally-polarized guided waves, termed Love waves.

Signal processing development showed that two procedures applied to the receiver signals could enhance echolocation. The first technique applied coherent subtraction. Coherent subtraction involves taking the receiver signal with a target and then subtracting from it the received signal without the target. This leaves mostly the target return signal, and usually provides about 13 dB of processing gain. The second technique took advantage of the characteristic of the surface Rayleigh wave that the vertical and radial components are 90 degrees out of phase. This phase relationship allows for filtering of the signals. This method, known as vector polarization filtering, (already mentioned) allows for the removal of other unwanted waveforms and enhances even more of the surface Rayleigh wave signal. The combination of these two



techniques provided excellent results in previous work [Refs. 9,10,14-18]. It should be mentioned that for a sonar operating under conditions of cylindrical spreading, a mere 12.5 dB enhancement wrought by signal processing, increases the sonar range by a factor of nine!

## **B. ROLLING LINE SEISMIC SOURCE**

This thesis documents the development and testing of a crude rolling line seismic source. To obtain some directionality for echolocation, source and/or receiver are spatially distributed over an aperture comparable to or greater than a wavelength, approximately one meter in the intended application. This consideration, and the need for a system which can be deployed while moving, has led to the concept of a rolling line source. The tube design allows for mobile, rolling deployment of a source and when coupled with a simplified driver and receiver array its use as a military asset is greatly enhanced, over fixed sources. The following chapters will discuss: the shaker assembly, mounting location of shaker assembly, force sensor testing, geophone and seismometer instrument, field testing of five seismic sources and wave speed measurements, and target echolocation experiment. Figure 2 is a photograph of a single rolling source element.



Figure 2. Rolling Line Source Element

THIS PAGE INTENTIONALLY LEFT BLANK

## II. ROLLING LINE SEISMIC SOURCE

The development of a mobile seismic source is part of an on going effort at the Naval Post Graduate School to develop a mobile seismic sonar for buried mine detection. Previous research has shown that a Rayleigh wave could be generated using several impulse methods. One method used was to place electrically driven mass slugs, which could be accelerated, to create an impulse. This method utilized a car audio shaker designed to vibrate a seat. This technology is similar to virtual reality games, where the steering wheel shakes when driving off the track. For the intended application, the source must be portable enough, for example, to move along with a small robotic vehicle.

### A. SHAKER ASSEMBLY

Previous seismic source development work at NPS proved that two car audio shakers, arranged in a push-pull configuration, so that the moving magnets oscillate in the same direction, could provide sufficient force for the intended application. Figure 3 below depicts a general setup.

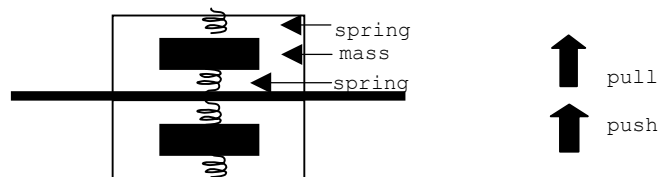

Figure 3. Magnetic Slug mounted together on a plywood board

This particular device was buried in the medium (sand). A 100 Hz single-cycle sine waveform was applied via an amplifier to induce the magnetic slug movement. Shaker specifications are given in Appendix B.

The rolling seismic source device being explored in the present investigation uses a similar setup for the car audio shakers, but the housing is much different, in order to take advantage of other attributes. Figure 4 is a photograph of the "last iteration" mounting configuration.

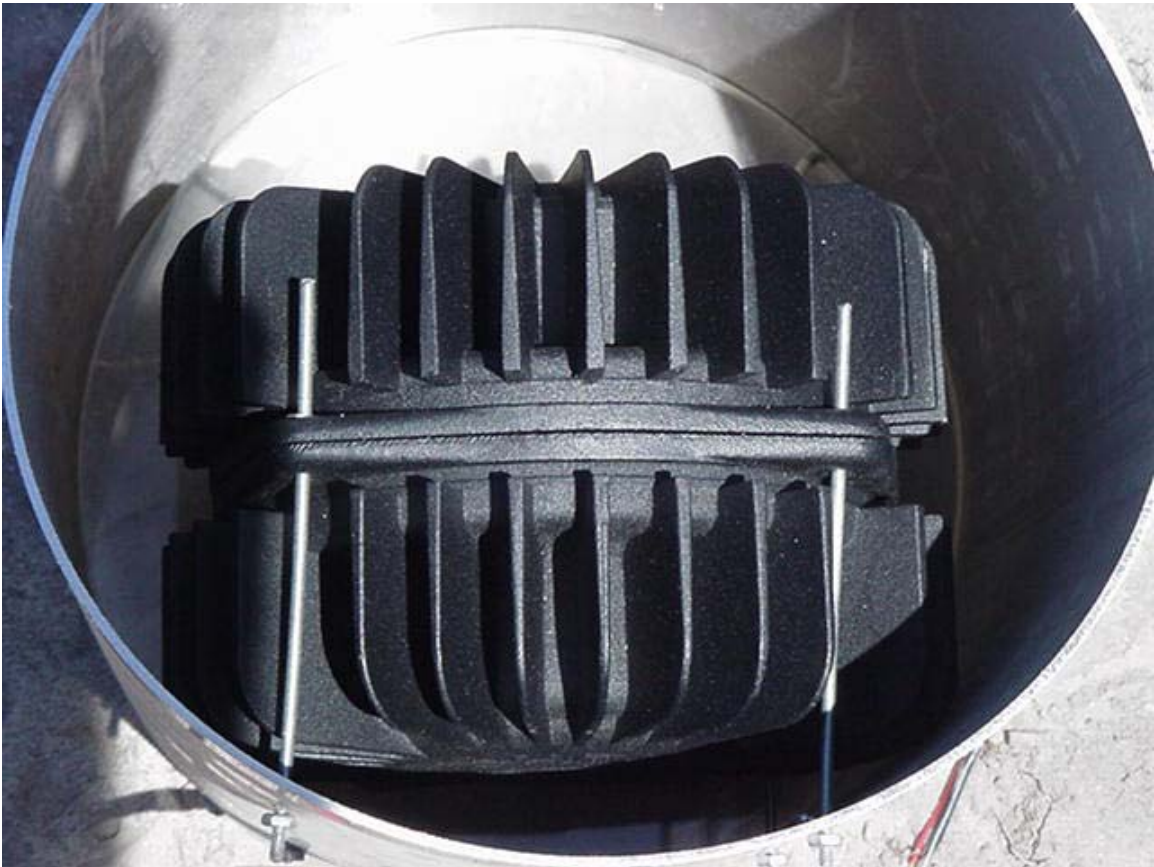

Figure 4. Shaker assembly mounted in tube

First, a desirable attribute of a seismic source is directivity. Using Huygen's principle of sources, a line source comparable to or greater in extent than a wavelength would produce radiational directivity. This was the basis of previous thesis work conducted by Kraig Sheetz (Ref. 17). From this principle, a line source was chosen as a good candidate for experimentation.

A second desirable feature is that the source should be mobile. It must be able to maneuver around barriers and obstacles or even roll over a small object. This led to the concept of a tube-shaped source similar to a rolling pin. If the radius of curvature was large enough to allow sufficient surface area in which a sufficient force could be applied, then, from elastic theory, waves could be generated in the soil or sediment.

The availability of material enabled the tube to be manufactured from twenty centimeter (8-inch) diameter aluminum pipe with a thin wall thickness (3 mm). The first shaker assembly, as described previously was mounted on a 2.5 centimeter (1-inch) square channel of aluminum, as an axis, with the same push-pull orientation described by Sheetz (17). The push-pull arrangement refers to how the magnetic slugs move in relation to one another. The slugs must move the same direction when a signal was applied. End caps were manufactured from acrylic, with a bushing assembly, to allow the tube to rotate and roll. The Aura

shakers used were a new version, capable of 75 watts continuous power, because they had the addition of heat sink fins (Fig. 4).

The shaker assemblies were mounted on the square axle using light screws and nuts. The tube axle arrangement was cut large enough to accommodate two sets of shaker pairs. The tube length was 48.3 centimeters (19 inches) with a small protrusion of the axle and wiring on each side. This initial design did not survive the testing with the force sensor, due to axle problems. The final configuration does not have an axle and the two shaker assemblies were separated. The separated shakers required the tube to be cut in half. The cylinder measures twenty-four centimeters (9.5 inches) in length, which is a quarter wavelength of the intended operating frequency. Figure 5 shows the deployment setup for this thesis.

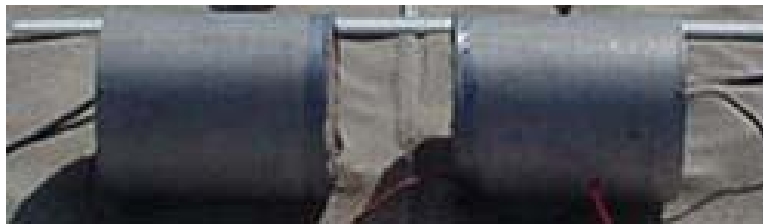

Figure 5. Two element rolling line source

## **B. FORCE**

The amount of force produced from the shaker push-pull arrangement is of significant interest. The

instrumentation available to explore the amount of force the shakers could produce was a Piezotronics 3-axis force sensor. This force sensor was used to measure the blocked force produced (a) by a bare shaker and (b) the tube assembly. The term "blocked force" means the force is measured under the condition of zero motion of the driving point. The sensor was approximately blocked by mounting it directly between the device being tested and a large steel plate lying on a concrete floor and held down with many lead bricks.

- a) The sensor was mounted directly between the shaker assembly and the steel plate, which was resting on a concrete floor, with small diameter bolts. This configuration allowed for measurement of the blocked force versus time. Figure 6 displays the orientation of the shakers, plate steel and force sensor. Calibration data and information for the force sensor are presented in Appendix C. Figure 7 is a block diagram of the equipment setup.



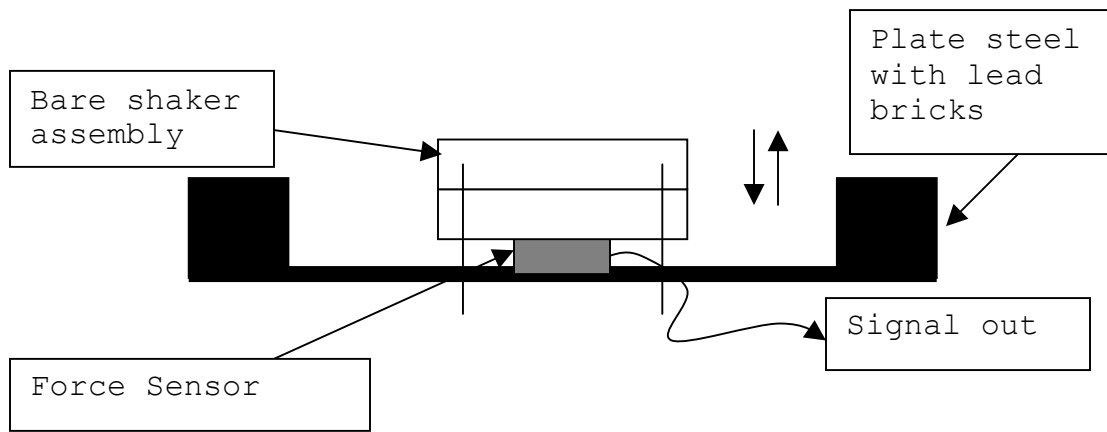

Figure 6. Force gauge measurement setup

The force gauge is manufactured to support Integrated Circuit Piezoelectric (ICP) output signals. The output from the z-axis was routed through the ICP power supply/amplifier to an oscilloscope. On the oscilloscope the input signal and the output force gauge signal could be monitored.

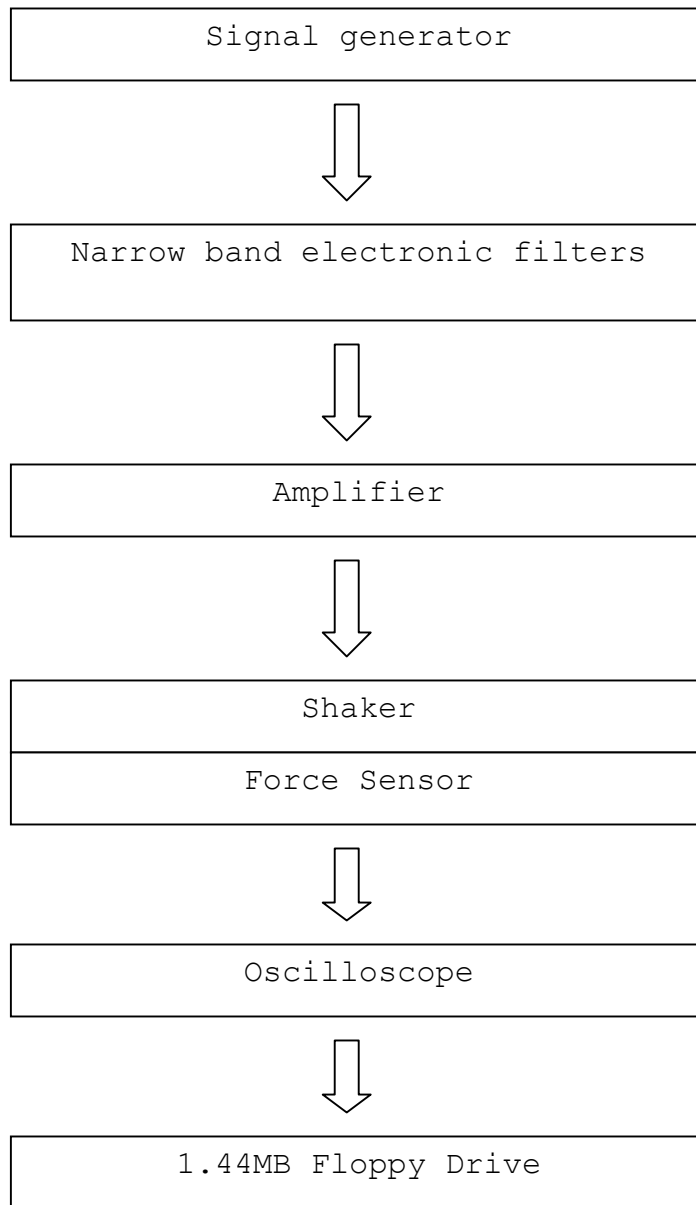

Figure 7. Block diagram of force sensor electronics

The main objective for this experiment was to find the limitations of the shaker, amplifier and the signal difference between input and output. Using the oscilloscope as

a data acquisition tool, the displayed signals were saved to a floppy disk in (x, y) format and merged into MATLAB for processing. Figure 9 shows the force sensor output for the bare shaker assembly.

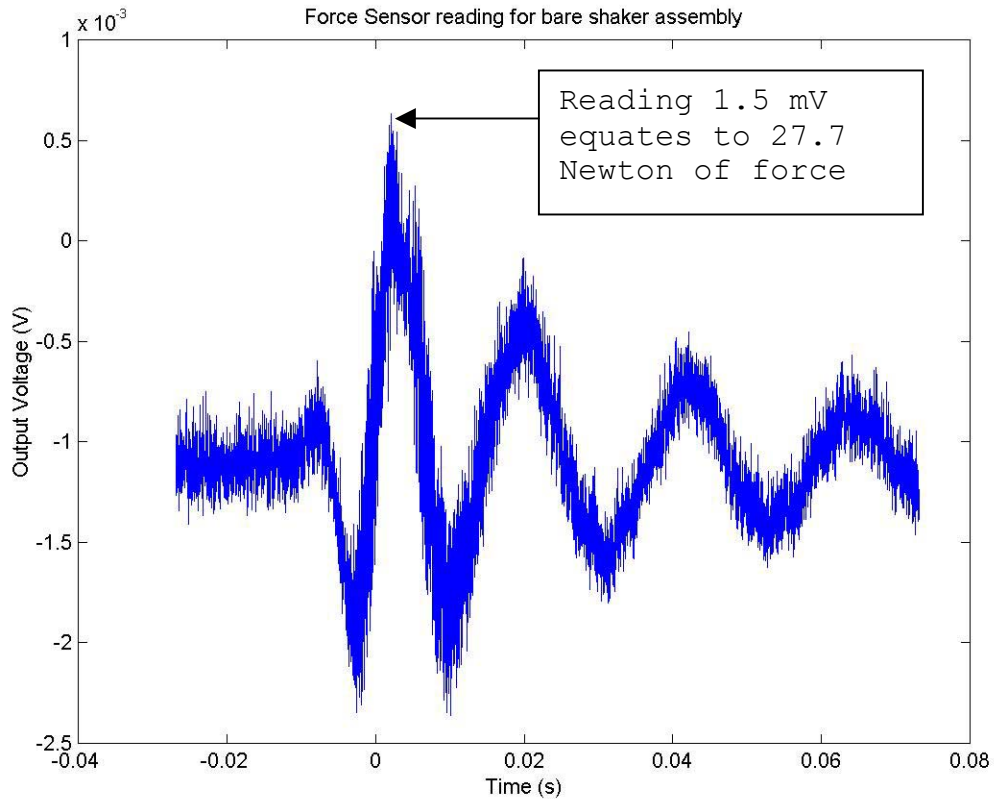

Figure 8. Force sensor reading for first positive peak (100hz single cycle signal at 0.28 Vpp)

Using the force sensor and input signal to the shaker assembly, it was possible to find the proper signal generator output voltage. The most limiting equipment component was the power amplifier. When the input signal was increased past 0.4 volts the

amplifier components would clip the signal to the shakers. Although the amplifier could still remain below an overload condition with clipping, the objective was to find a suitable signal generating voltage, to ensure measurement accuracy. It was found that 0.28 volts became a good standard for this testing. Using a 0.28 volt 100 Hz single cycle sine wave to drive the "bare" shaker assembly, the force sensor output was measured to be a maximum at 1.5 milliVolts. This force sensor reading equates to 27.7 Newton. Initially, the input filter settings were set at 100 Hz (low pass) and 50 Hz (high pass) to ensure the wave would be smooth, such that the power amplifier input signal would not have any sharp transitions. The power amplifier also was equipped with filters. These filters were adjusted to allow for a single cycle sine waveform to be smoothed for fieldwork. Once the amplifier was setup there was no longer a need to filter the input signal. With the power amplifier setup correctly the output force per volt of drive was 98.9 Newton/volt.

- b) The next step was to reassemble the tube with a single shaker set and perform the measurement again. Figure 9 shows a sketch of the tube and force gauge arrangement.

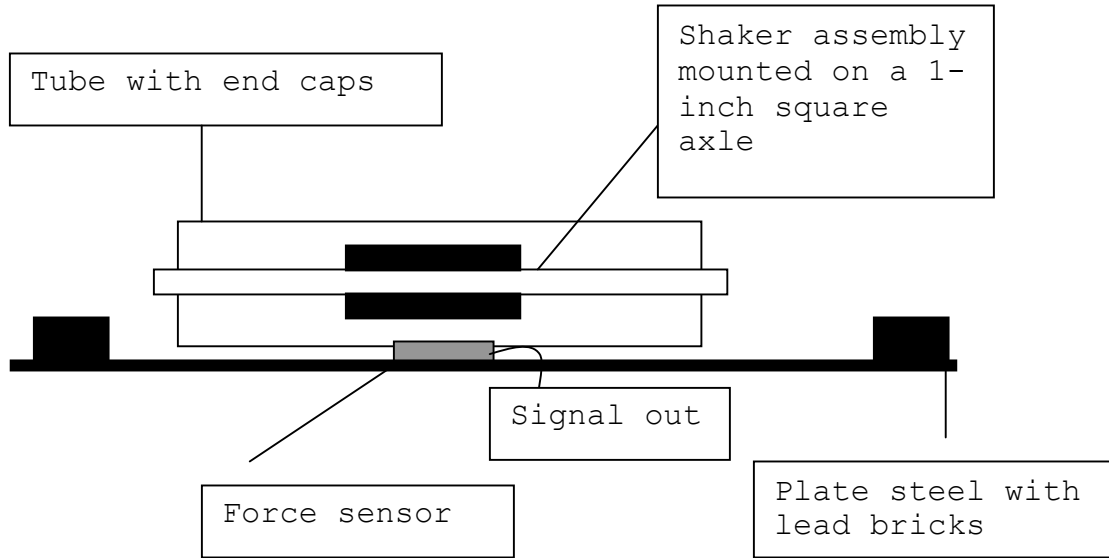

Figure 9. Tube Assembly and Force gauge

The same setup as figure 8 was used to test the force response of the shaker assembly mounted on an axle and placed in the tube. Figure 10 shows the force sensor response with the tube fully assembled and with only the bare shakers.

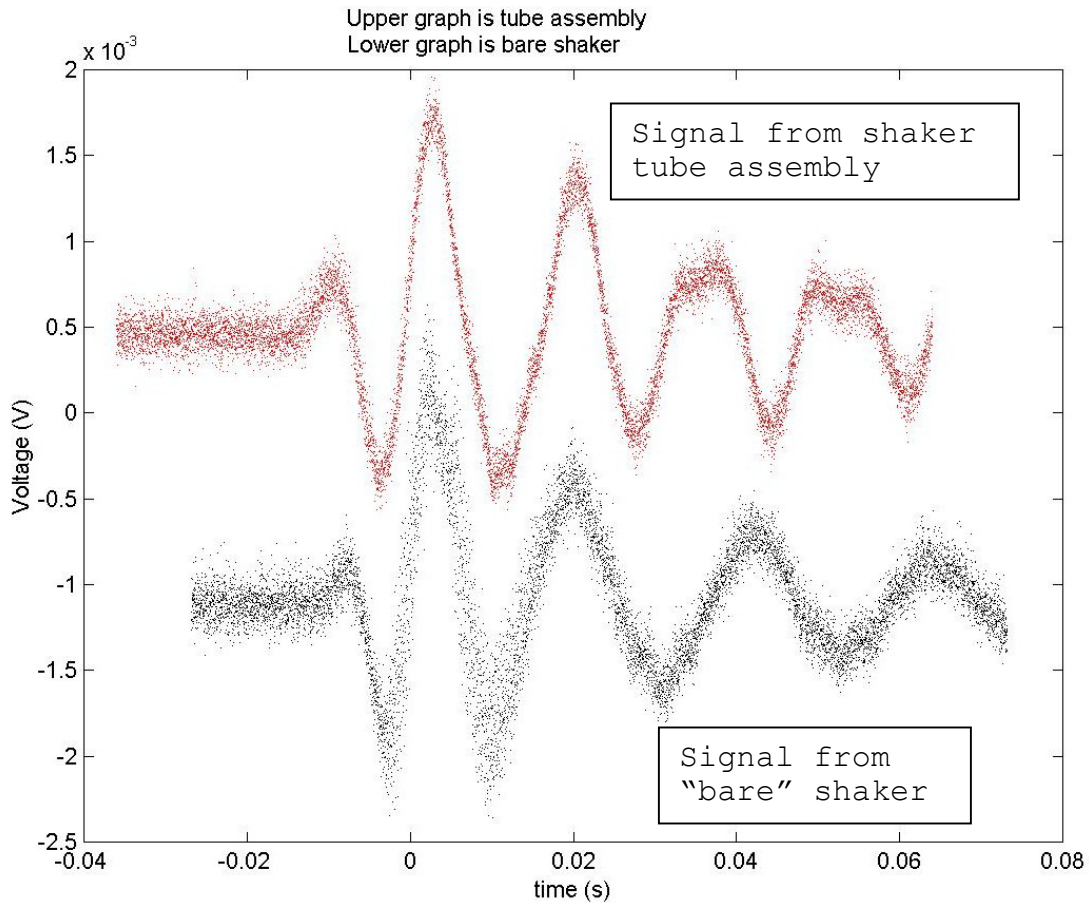

Figure 10. Force measurements with tube and bare shaker assembly

The two graphs in Figure 10 are very similar. The "bare" shaker and shaker tube were each driven with the same 100 Hz single cycle sine wave. When the bare shaker and tube shaker plots are superimposed the two are nearly indistinguishable from one another. The force sensor measurement for the tube shaker is 25.8 Newton (1.4 millivolts) and an output sensitivity of 92.3 Newton/Volt.

### C. GEOPHONE AND SEISMOMETER INSTRUMENT

A geophone consists of a metal case with two coils, one wound clockwise and the other wound counterclockwise, and a suspended magnet attached by a spring on both ends (Figure 11). In general, when the geophone is placed on a surface and the surface moves, the case (coil windings) moves as well. Since the permanent magnet is suspended by springs, the magnet remains stationary as the case moves. The magnetic field lines are cut by the coils and an electromotive force (emf) is produced. The emf output is proportional to the coil's movement and can be read off of the terminals as a voltage. The geophones used during this experiment are Model SM-11 made in the Netherlands and sold by Input Output Inc. of Houston Texas. A picture of the SM-11 geophones mounted on three axes, assembled by Jay Adeff (NPS), is shown in Figure 12. When the geophones are mounted in a 3 axis configuration, the assembly is a seismometer.

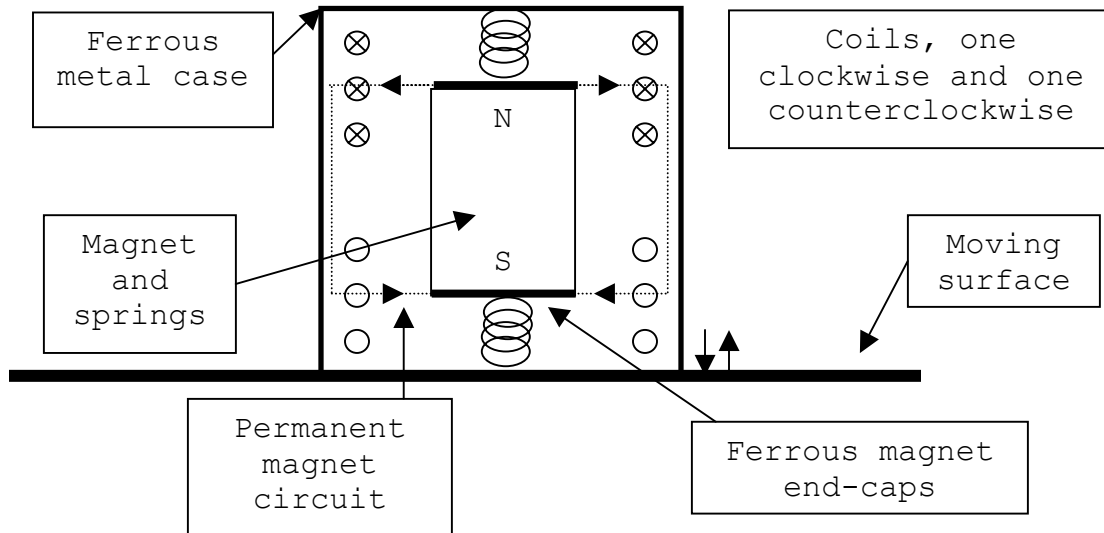

Figure 11. Basic Geophone construction



Figure 12. SM-11 geophones mounted on three axes

The particulars of the geophone itself are very interesting and will only be briefly discussed. As with any electromechanical device, there are limitations to its response. There are two things to consider with respect to the geophone. First is its sensitivity. The instrument can be too sensitive and cause large readings from a small noise source, which could mask the signal of interest (too much noise). The second item of concern is damping. Once the coil is placed in motion, there is a restoring force from internal balance springs and from emf in the coil assembly. These work together to dampen the output signal. The amount damping depends mostly on the springs.

For use in this device the geophone needs a correctly damped linear response. The Input-Output SM-11 geophone was utilized for this purpose. The SM-11 has very good linear response to small-scale movements. It also has a



"built in" high pass filter which reduces noise from waves crashing on the beach, making noise below 30 Hz. Specifications for the SM-11 geophone are found in Appendix A.

#### **D. LABORATORY TANK TEST**

At NPS there is a small circular tank with an approximate diameter of 4 meters and is about 1 meter deep. The tank is filled with medium grade sand, which is representative of a beach. In general, the tank is not large enough to perform actual experiments. It is mainly used for equipment checkout prior to field-testing. The main check out experiment performed was with the tube reassembled with one shaker set. The tube was placed off the axis of the circular tank and three signals were recorded. The recording device was a 3-axis seismometer directly connected to an oscilloscope. The seismometer was placed about one meter from the perpendicular axis of the tube. This is shown in Figure 13 below. This orientation was to minimize reflection of the waves. The electronic equipment setup is shown in Figure 14.

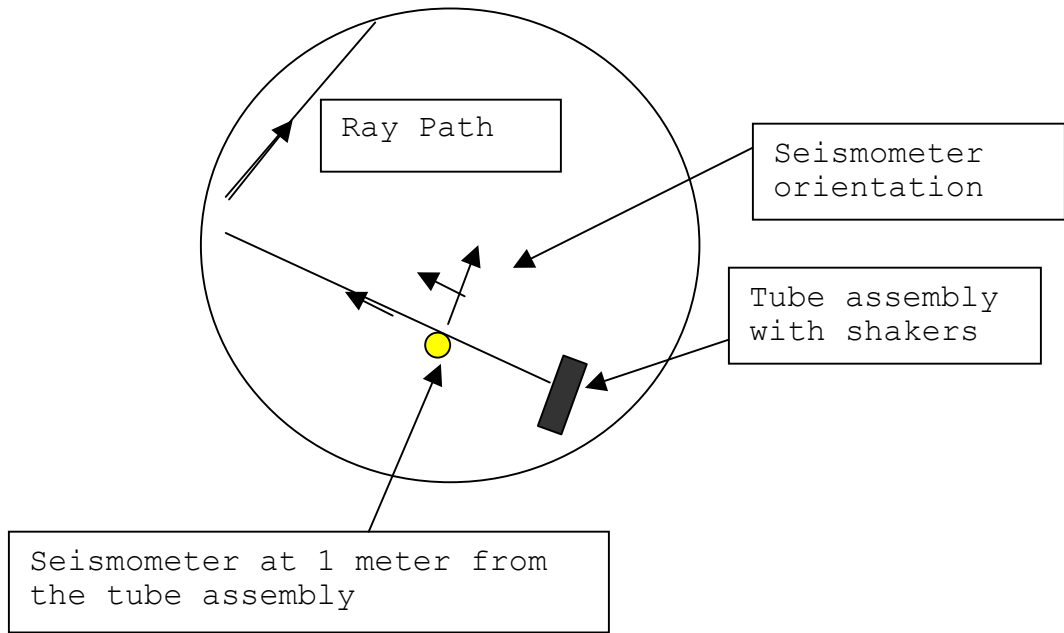

Figure 13. Tube and Seismometer

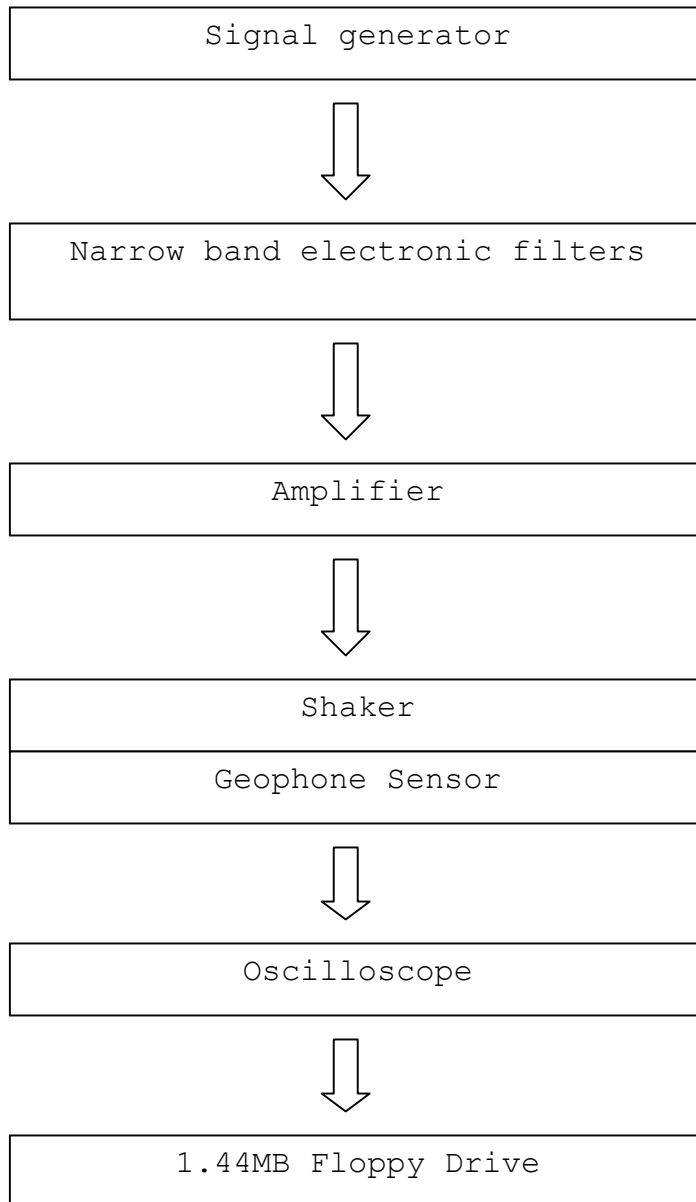

Figure 14. Electronic setup for tank test of rolling line source

As for previous tests, a 100 Hz single sine wave was applied as an input to the rolling line source. The filtered signal was sent to the tube through an 800 watt amplifier. The amplified signal caused the shakers to move and this movement provided the seismic impulse into the

medium. The impulse traveled through the sand. The seismometer measured the movement of the sand caused by this wave, including reflections off the tank's floor, and its walls. For this test the vertical movement is of most importance. The vertical movement, as the wave passes, should ideally mimic the output of force sensor in its shape.

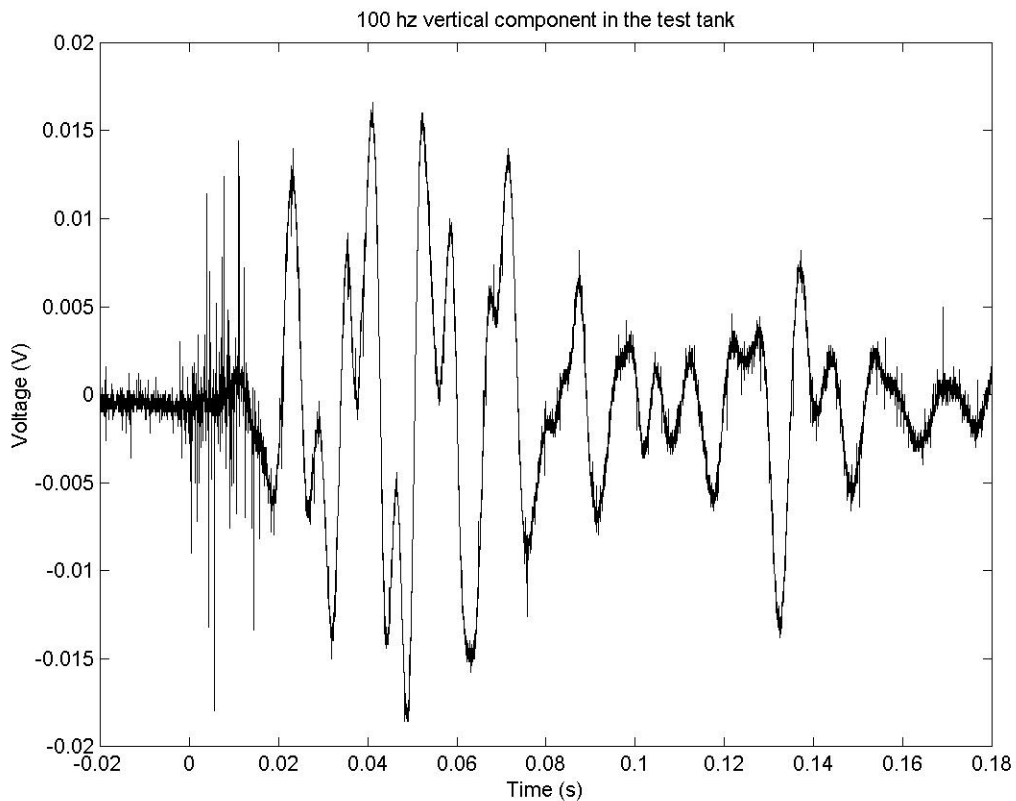

Figure 15. Seismometer vertical response in tank 1 meter from source with an input signal of a single sine wave at 100 Hz

Even though the signal shape in Figure 15 did not match the force sensor, the features of the received signal seemed to be acceptable. The time record showed some

promise, so this assembly was considered ready for field-testing. During the initial field test the seismometer output signal proved unreadable. The root cause stemmed from mounting the bare shaker assembly to an axle, which vibrated. The axle was removed and the bare shakers were mounted directly to the tube inner wall using thin bolts. The previous force sensor measurement was then performed with good results. Figure 16 shows the smooth wave generated from the force sensor experiment for a one cycle sine wave input at 100 Hz.

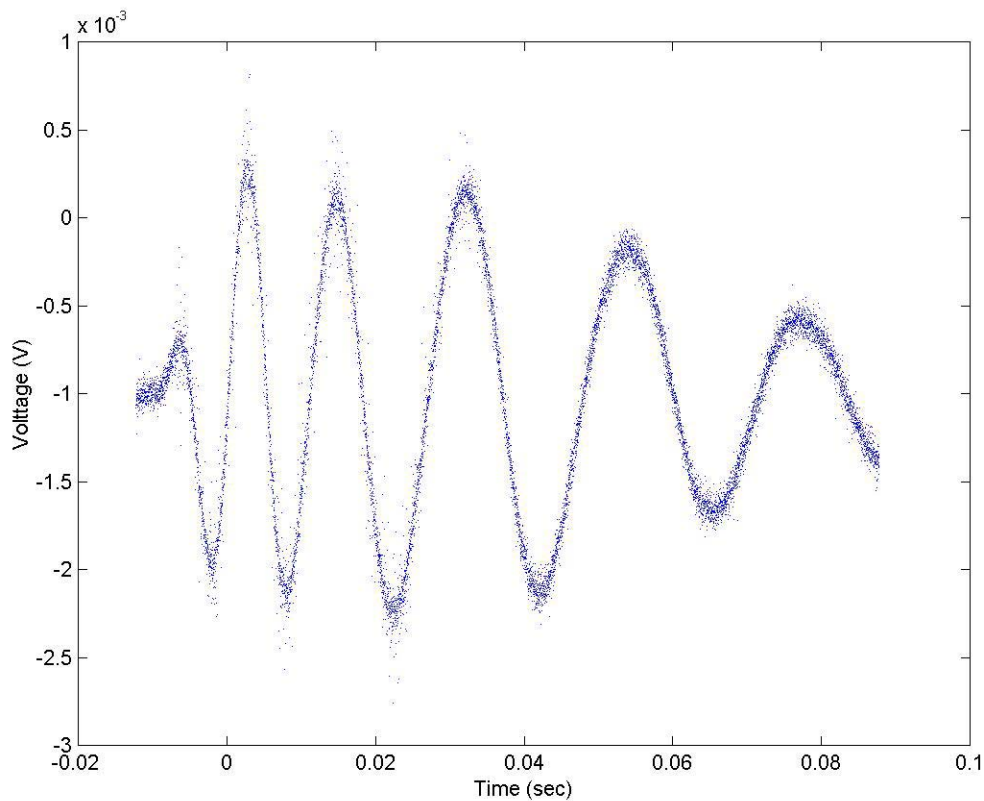

Figure 16. Force sensor with Shaker mounted to the tube for a single cycle 100 Hz sine wave

### III. FIELD TESTING

Field testing of the rolling seismic source was conducted on a stretch of the Navy beach on Monterey Bay, across from NPS. An instrument trailer had been previously configured to house research equipment, and placed directly on the beach, by means of a small four wheel drive vehicle. Various electrical cables were run to signal receiving units, and were routed to a single four-channel oscilloscope. Using a function generator, a single sine wave was fed to several sources via an amplifier. The 100 Hz sine wave was a single cycle at 0.28 Vpp with a repetition period of approximately one second. The amplifier was a two-channel 800-Watt car audio amplifier. Only one channel was utilized. The amplifier output was 48.8 Vpp and the measured current was 22 amps. This equates to approximately 380 Watts RMS, assuming a resistive load. The amplifier has a rating of 400 Watts per channel. The shakers could be driven with more power but signal clipping within the amplifier would have created an unwanted waveform. The electronic equipment configuration (Figure 17) allowed for the testing of five sources by only changing the sources.

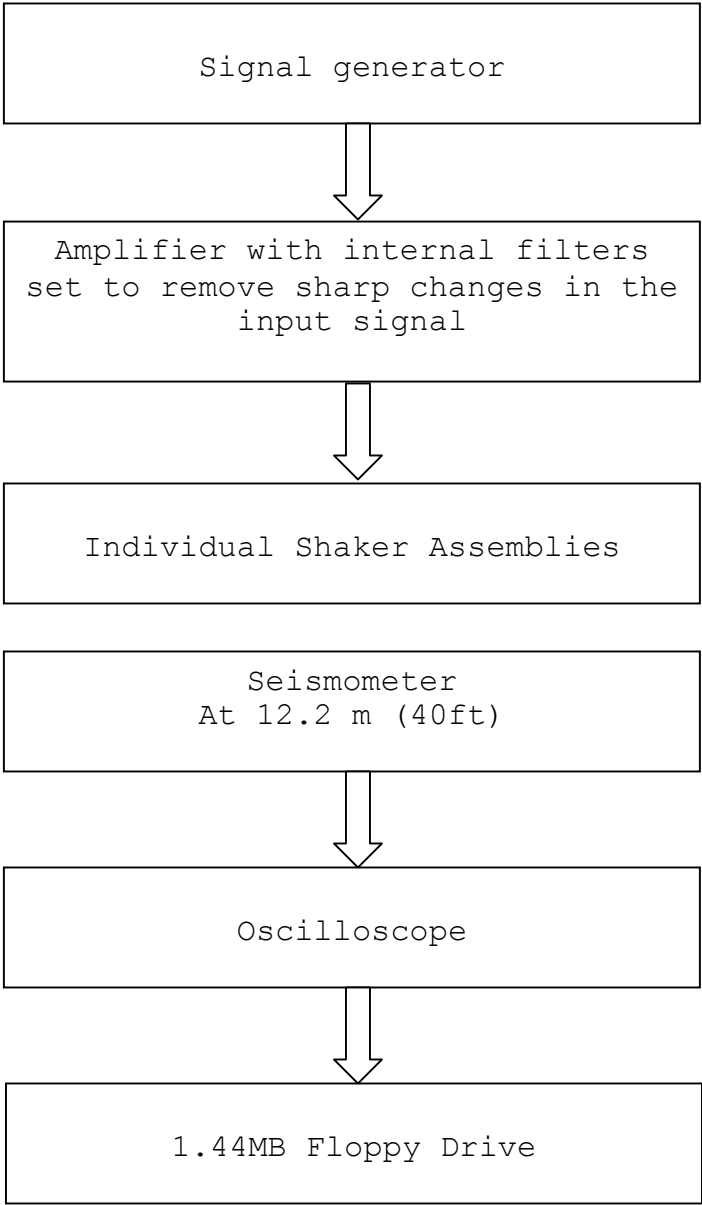

Figure 17. Field testing electronics setup

**A. FIVE SOURCES USED IN COMPARATIVE TESTING**

Five separate seismic sources were tested (Figure 19). Each source was driven with the same input signal. Source one was a paddle type described in section II Figure 3, from Sheetz's thesis [Ref. 17]. This paddle type source was buried in the sand in a horizontal position. Source two was the same paddle source but laying horizontally on the surface. Source three was a single shaker, removed from its casing, and heat sink, and buried. Source four was the rolling line source shaker. And source five was the paddle shaker assembly buried vertically. The receiver used for this experiment was a highly sensitive three-axis, rocket shaped, seismometer with a 40 dB internal preamplifier, buried just beneath the surface, 12.2 meters (40 feet) away (Figure 20). The general arrangement of the experiment is shown in Figure 18.

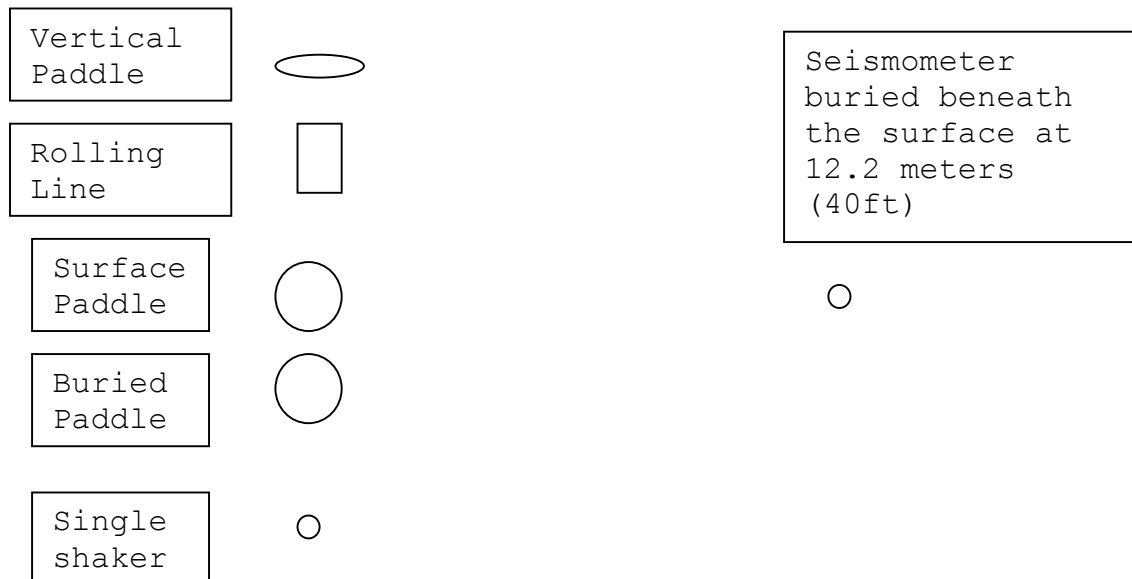

Figure 18. Five source beach deployment





Figure 19. Photo of the Five Sources



Figure 20. Photo of buried seismometer at 12.2 m (40ft)

**B. SIGNAL COMPONENTS MEASURED AT 12.2 M (40 FT) RANGE**

Using the described configuration, both the vertical (z component) and radial (x component) were recorded. These signals show very similar characteristics in each time record. The two sources of greatest interest are the buried paddle source and the rolling line source. These two sources show received signals, which are similar both in amplitude and shape. Figure 21 displays both radial and vertical time series data, for all five sources.

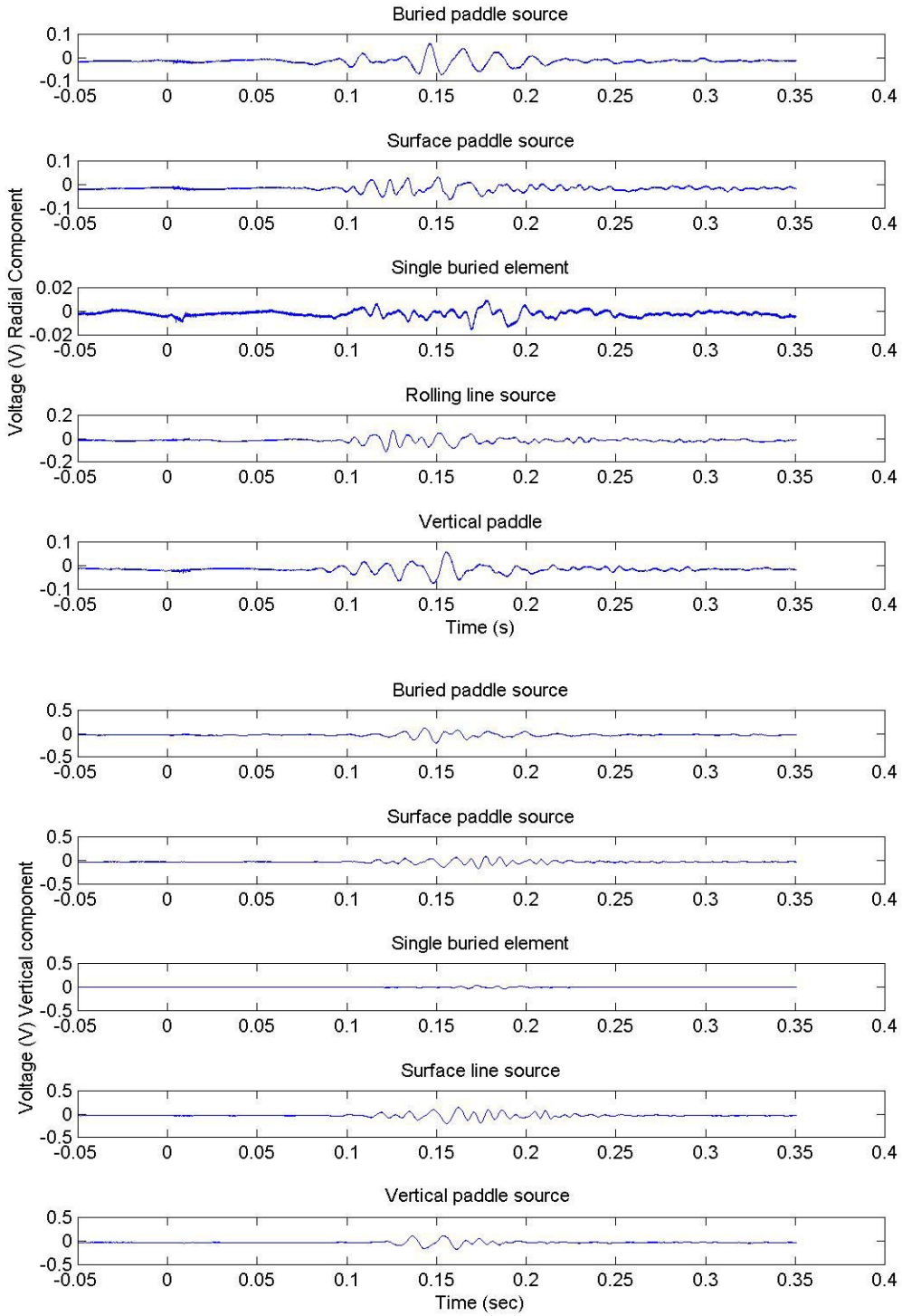

Figure 21. Radial and vertical time series data for all five sources

From Figure 21, it can be seen that the rolling line source and the buried paddle source produce very similar signals at the field point. All the signals can easily be picked out of the noise. The rolling line source seems to contain higher frequency components. Figure 22 shows the vertical component signals received from the rolling line and buried paddle source, plotted together against time. Figure 23 shows the radial component signals received from the rolling line and buried paddle source, plotted together against time.

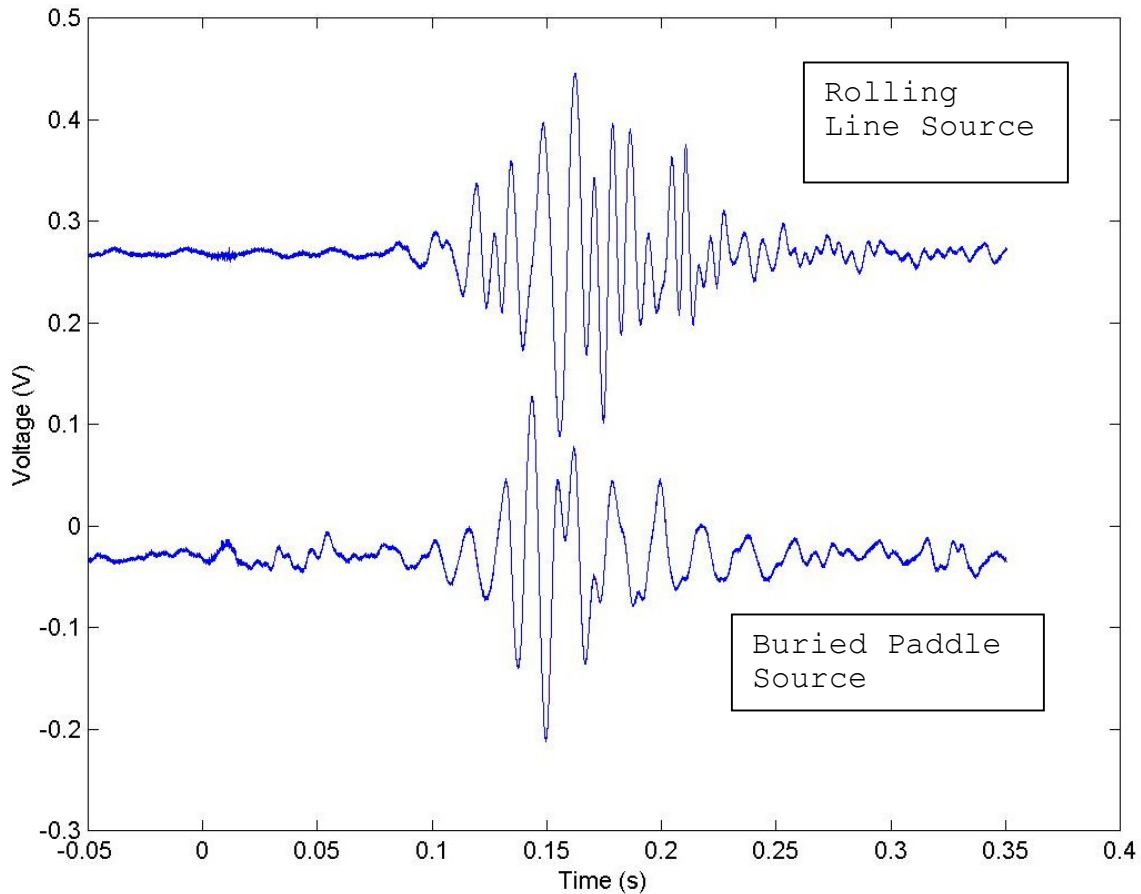

Figure 22. Vertical component received signal from the rolling line and buried paddle source at a range of 12.2 m (40ft)

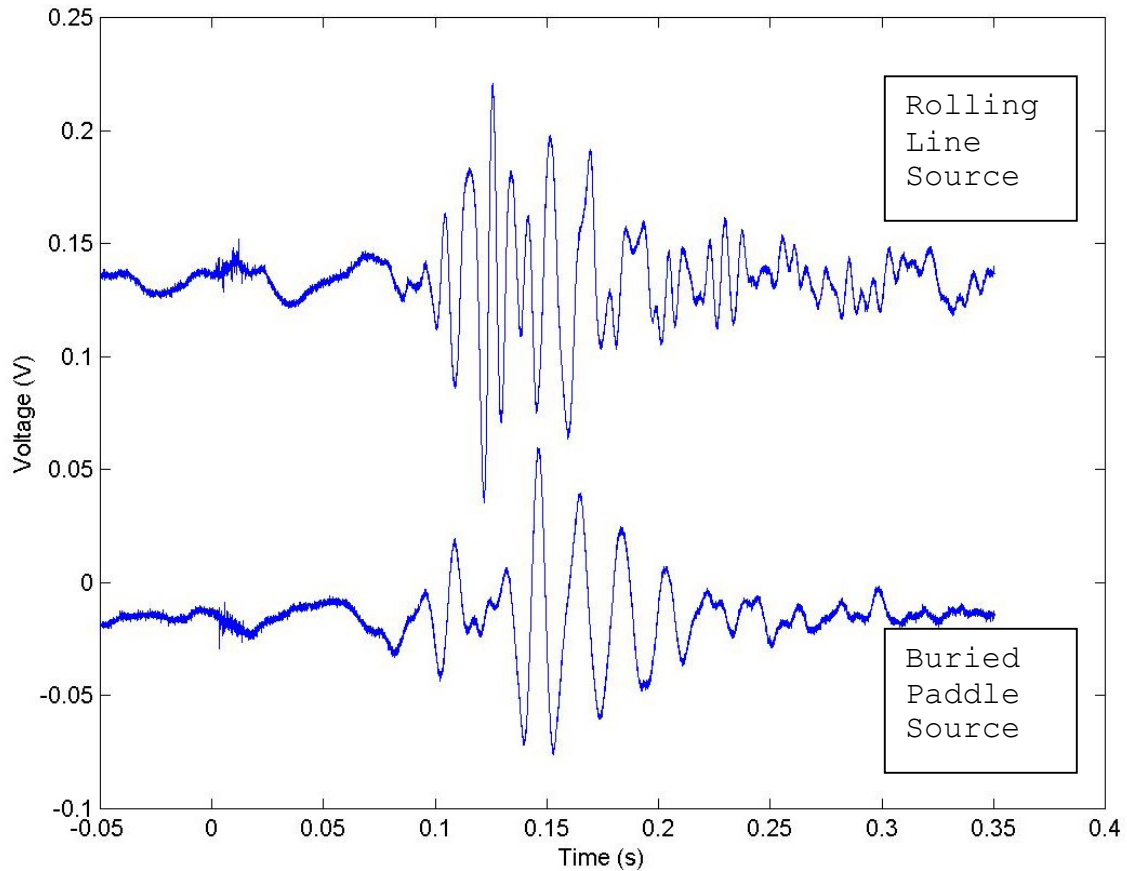

Figure 23. Radial component received signals from the rolling line and buried paddle source at a range of 12.2 m (40ft)

These plots show that the output of the tube and the buried source are very similar and the waves generated are similar to each other. Again, the rolling line source seems to contain higher frequency components. In addition, the tube signal shows that it can be extracted from background noise.

### C. SIGNAL CORRELATION DOWN RANGE

A signal correlation analysis was performed to determine at what range the signal can still be extracted. For this experiment, one of two identical surface seismometers were placed at 1 m (3ft) from the tube sources and the second was placed down range at 43.6 m (143ft) (Figure 24). Two tube sources were placed end to end with a separation of a few centimeters. Each tube was driven with the same signal, as described previously, via a T-connection. Using a Dynamic Signal Analyzer in cross correlation mode, the vertical signal down range was successfully correlated (Figure 25). For this experiment, the down range seismometer required a preamplifier set at a gain of 10X. The signal analyzer, when placed in cross correlation mode, shows a peak at the correct time difference between channel 1 and channel 2. The seismometers were placed at different distances, and the time shift was used for wave speed calculations.

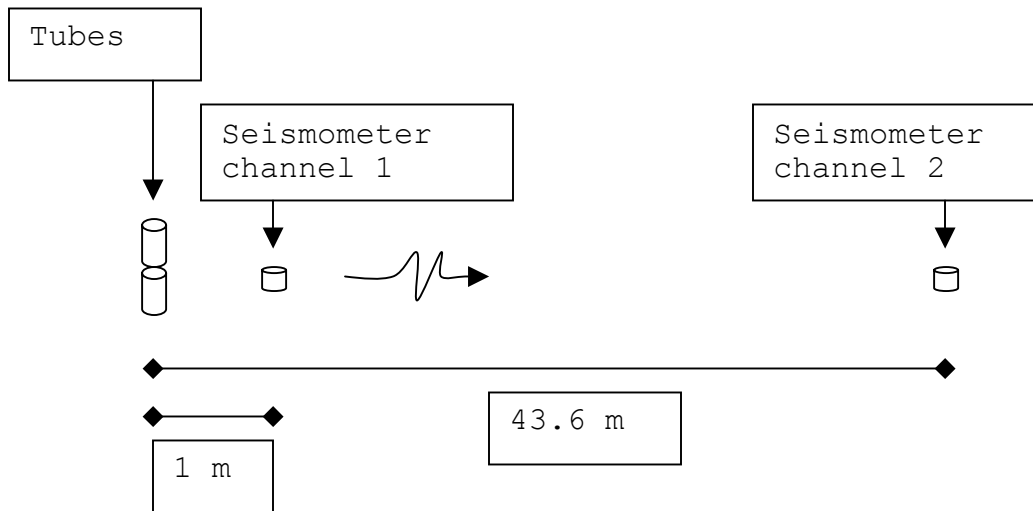

Figure 24. Beach setup for cross correlation



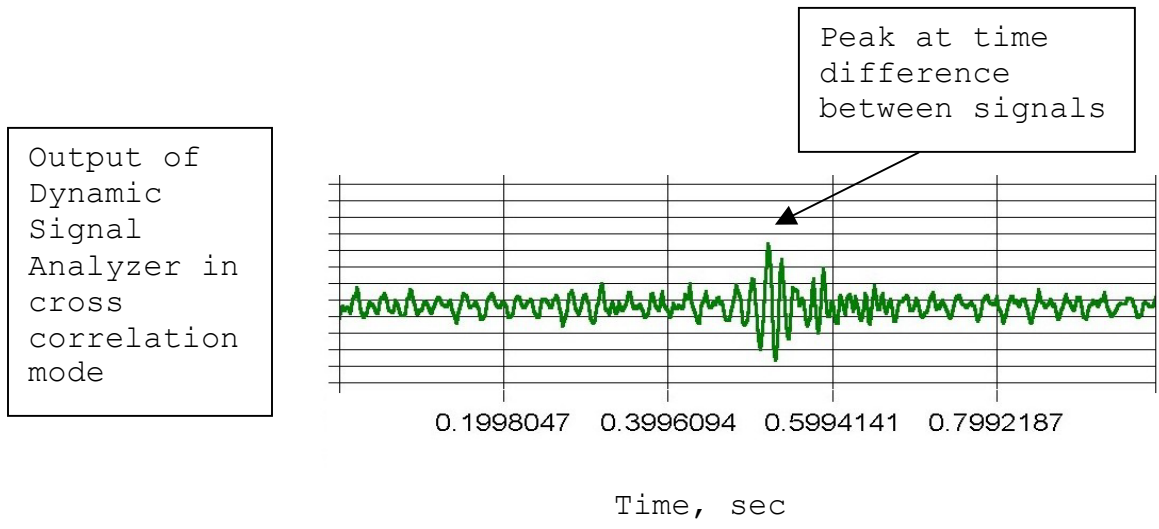

Figure 25. Correlation measurement of vertical down range signal at 43.6 m (143ft)

**D. WAVE SPEED**

To determine wave speed, the time delay from cross correlation was used, along with a physical, "on the ground" measurement of distance. To verify that this method was satisfactory, time trace signals were also used to find an initial time delay and then were compared to correlation data. To calculate wave speed, the measurement of distance between seismometers and signal arrival time difference was used. Figure 26 shows time traces 43.6 meters (143ft). The matching peaks from each seismometer had a time delay of 0.52148 seconds. Table 1 shows all time delays and wave speeds.

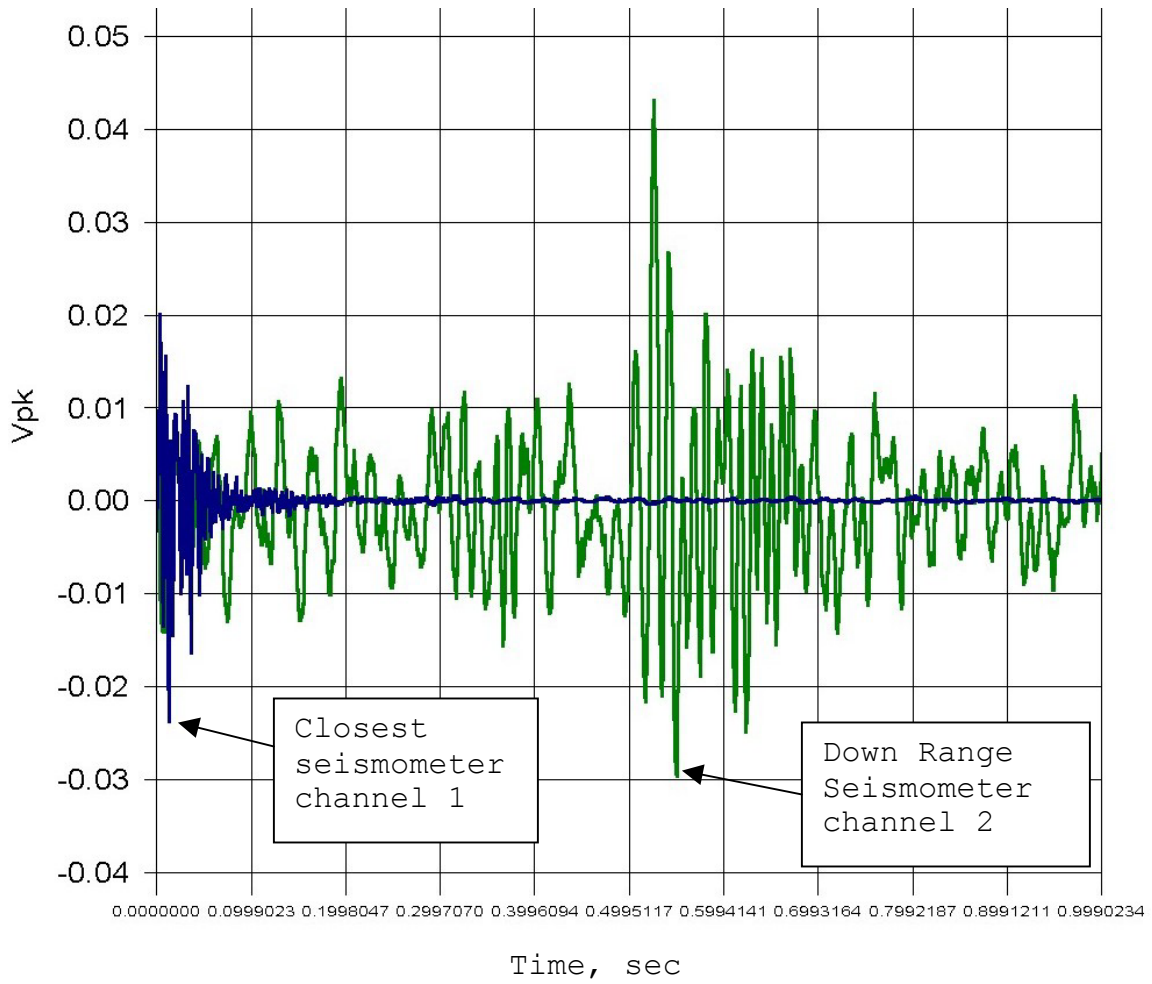

Figure 26. Time record of two seismometers separated by 43.6 m (143ft)



Method	Distance	Correlation Time	Speed
Cross Cor	44.21 m	0.52148 s	84.8 m/s
Cross Cor	44.21 m	0.52148 s	84.8 m/s
Cross Cor	44.21 m	0.52148 s	84.8 m/s
Cross Cor	44.21 m	0.52148 s	84.8 m/s
Cross Cor	28.42 m	0.34375 s	82.7 m/s
Cross Cor	23.68 m	0.28125 s	84.2 m/s
Cross Cor	15.79 m	0.19531 s	80.8 m/s
Cross Cor	15.79 m	0.19141 s	82.5 m/s
Cross Cor	15.79 m	0.19531 s	80.8 m/s

Table 1. Seismic Interface wave speed on Monterey Beach

From Table 1 the mean (group velocity) wave speed is 83.2 m/s with a standard deviation of 1.9 m/s. This value matches previous thesis work of 80 m/s  $\pm$  10 m/s [Refs. 14,17].

#### IV. TARGET ECHO-LOCATION EXPERIMENT

In order for the rolling line source to be useful in an application it must be able to receive backscatter from a target. Previous thesis work by Sheetz [Ref. 17] and by Fitzpatrick [Ref. 15], and by Hall [Ref. 16], showed that a Rayleigh wave could be used to find buried objects. To keep the experiment simple, a target was placed perpendicular to a pair of tube sources. The sources were pulsed with a single wave generator to ensure that they were driven identically. The surface sources and receiving array were arranged such that six seismometers of the receiving array were 40 cm ( $0.48 \lambda$ ) apart on a perpendicular line from the radial, and the source was placed directly behind the array (Figure 27). The receiving array sensor outputs were wired in series to ensure the voltage potential would be summed. The array output was routed to a dual channel Digital Signal Analyzer. The analyzer was selected to correlation mode and placed in dual channel configuration. An external trigger was run from the signal generator. The array's radial and vertical seismometer components were placed on separate channels. Figure 28 is a block diagram of the electronic equipment setup.

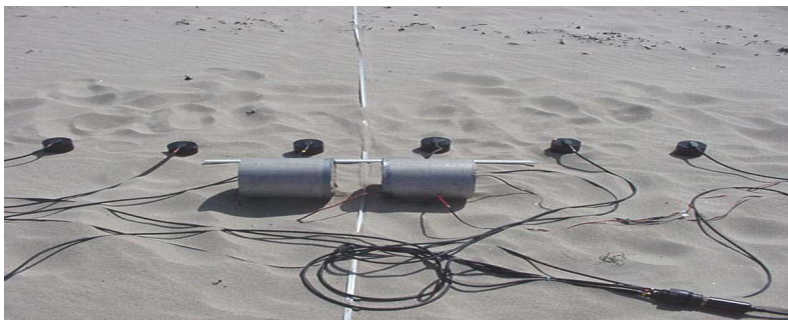

Figure 27. Seismometer array and tube surface sources

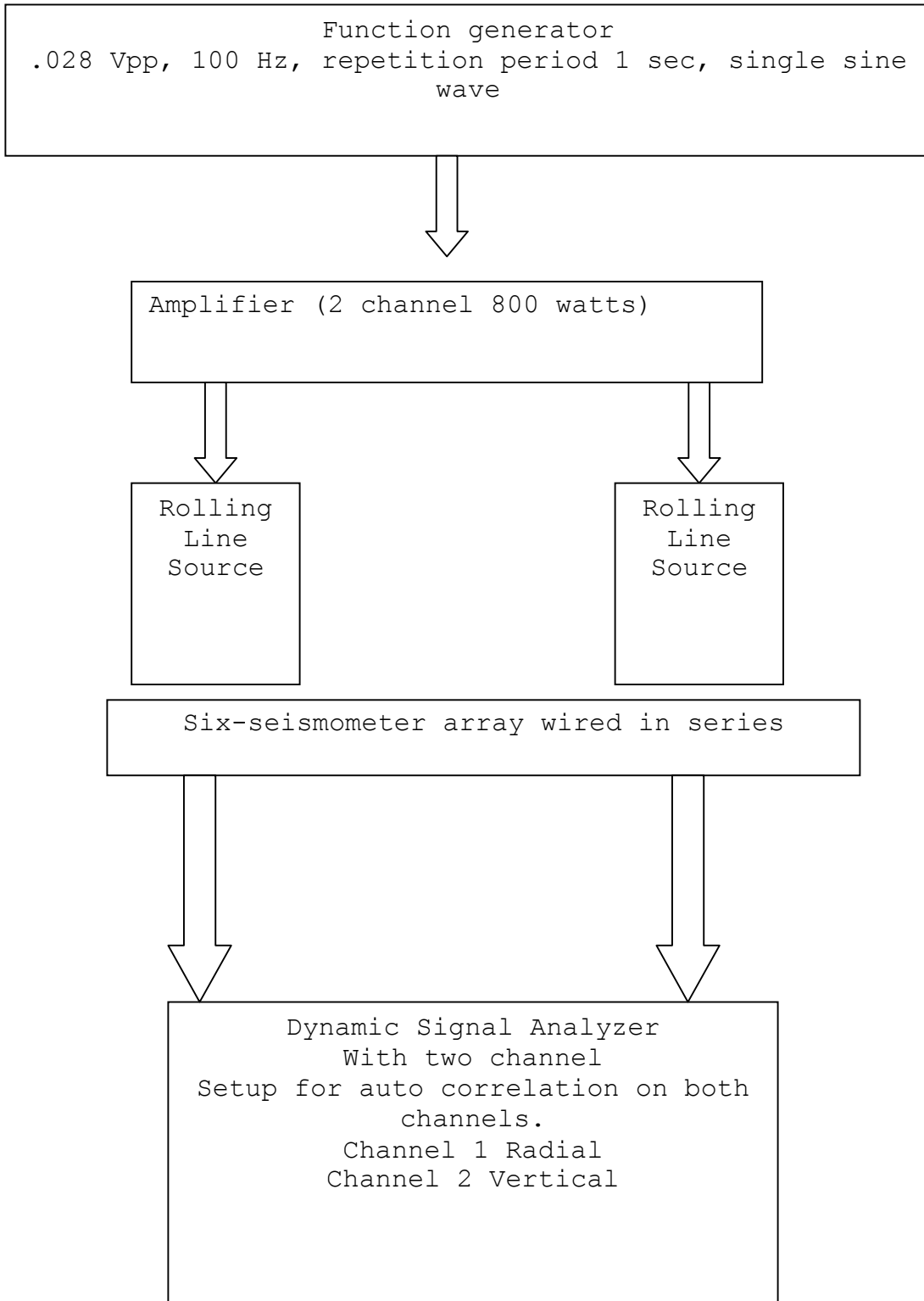

Figure 28. Electronic setup for Target Echo-Location

**A. 1000 LB. BOMB TARGET**

A general-purpose, 1000-lb bomb, used in many countries all over the world was used as a test target. The bomb measures two meters in length and has a radius of seventeen centimeters at its largest point. This air dropped bomb has a traditional streamline shape and is made of steel. An inert version of this bomb was buried just below the surface as depicted in Figure 29.



Figure 29. Inert 1000 lb. bomb being buried in the sand of the Navy beach on Monterey Bay

The bomb was placed 5.79 meters (19ft) from the array, as depicted in Figure 30.

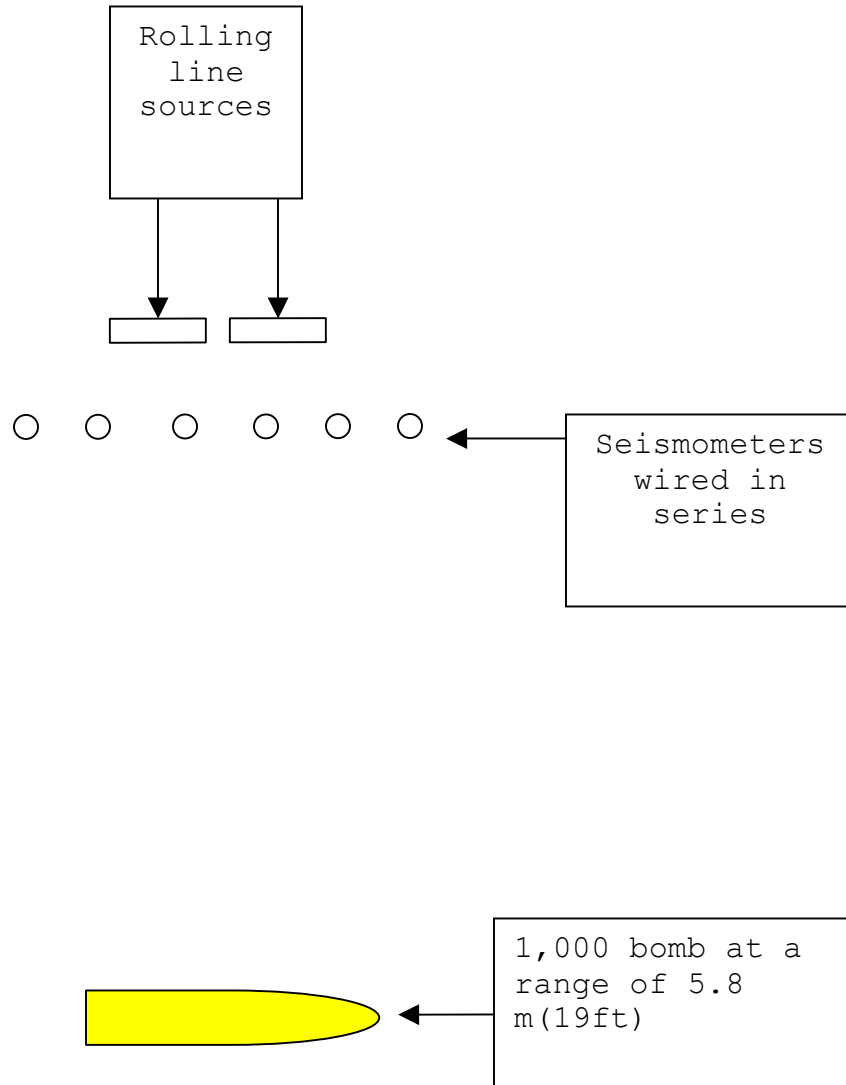

Figure 30. 1,000 lb. bomb experiment with rolling line sources

The dynamic signal analyzer auto-correlated the radial and vertical signals. The return is observed as a secondary wave packet. The wave packet should be time displaced by 150 milliseconds. Figure 31 is the analyzer

data screen for auto correlation with bomb present. The strongest correlation of the echo-return from the target was found at approximately 150 ms, corresponding to a wave speed of 83 m/s. Figure 32 is a graph of auto correlation without target bomb present. The lack of a response at about 150 ms in the trace with no bomb present confirms the return is from the target.

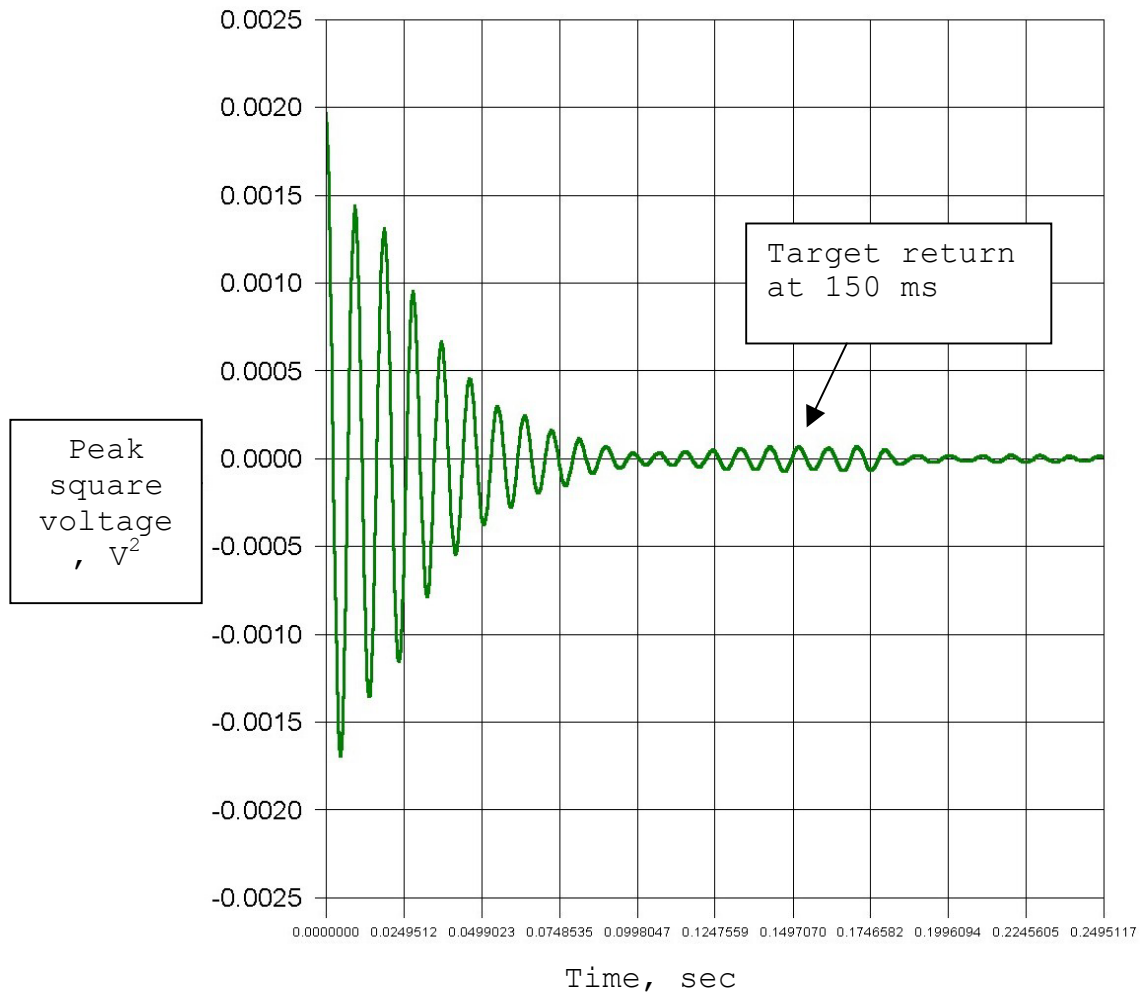

Figure 31. Radial Auto-Correlation for bomb

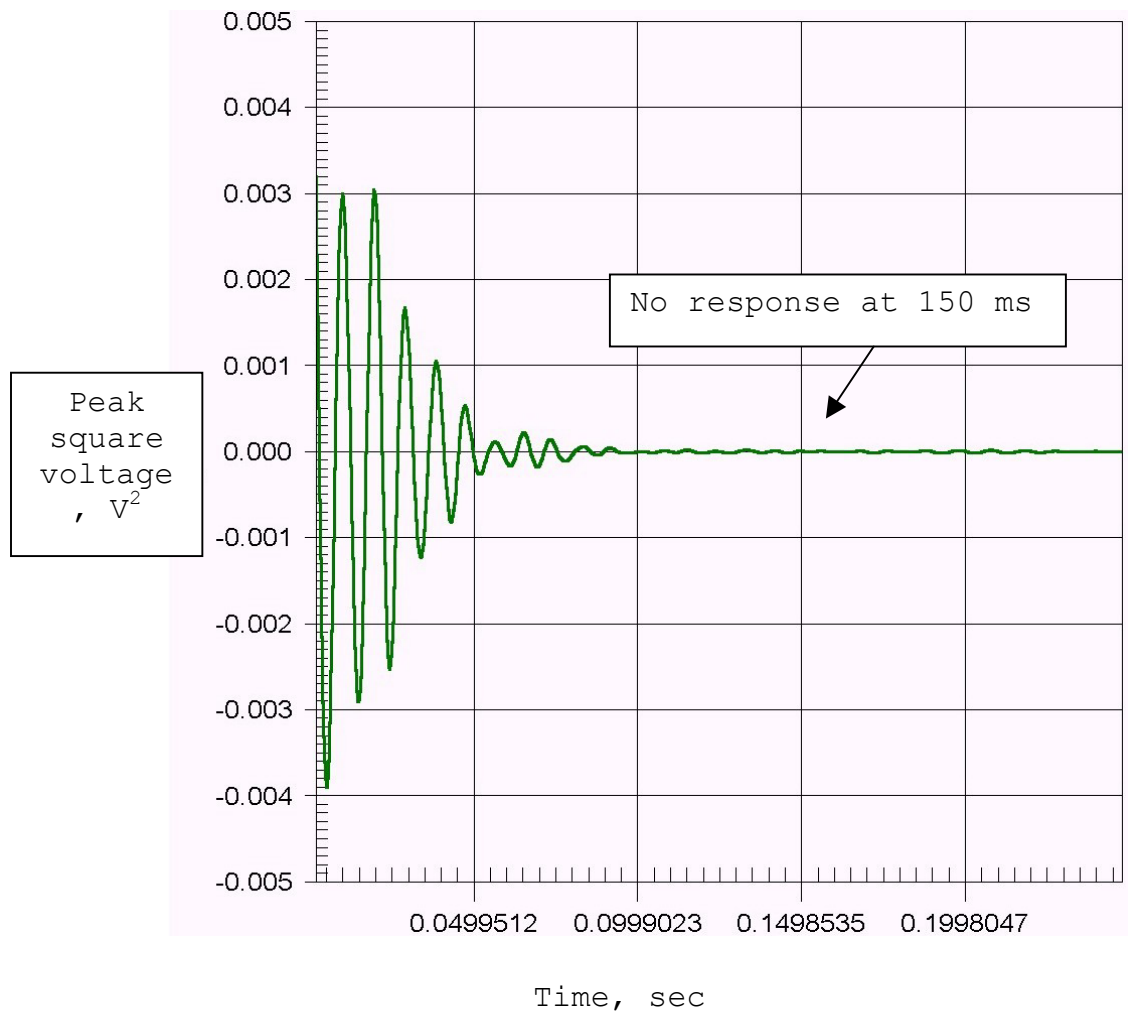

Figure 32. Radial Auto Correlation record without bomb

The above results were obtained without any external (laboratory) program or receiver amplifiers. The time signal shows this same result (Figure 33). Had time permitted and had we utilized vector polarization filtering, as did Smith, et.al. [Ref. 10], Fitzpatrick [Ref. 15], Hall [Ref. 16], Sheetz [Ref. 17], Guy [Ref. 18], the target return depicted in Figure 31 would have been some 20 dB (factor of 10) higher. Had time permitted and

had we combined vector polarization with the type of correlation processing used here, the echo to reverberation ratio would have been even higher.

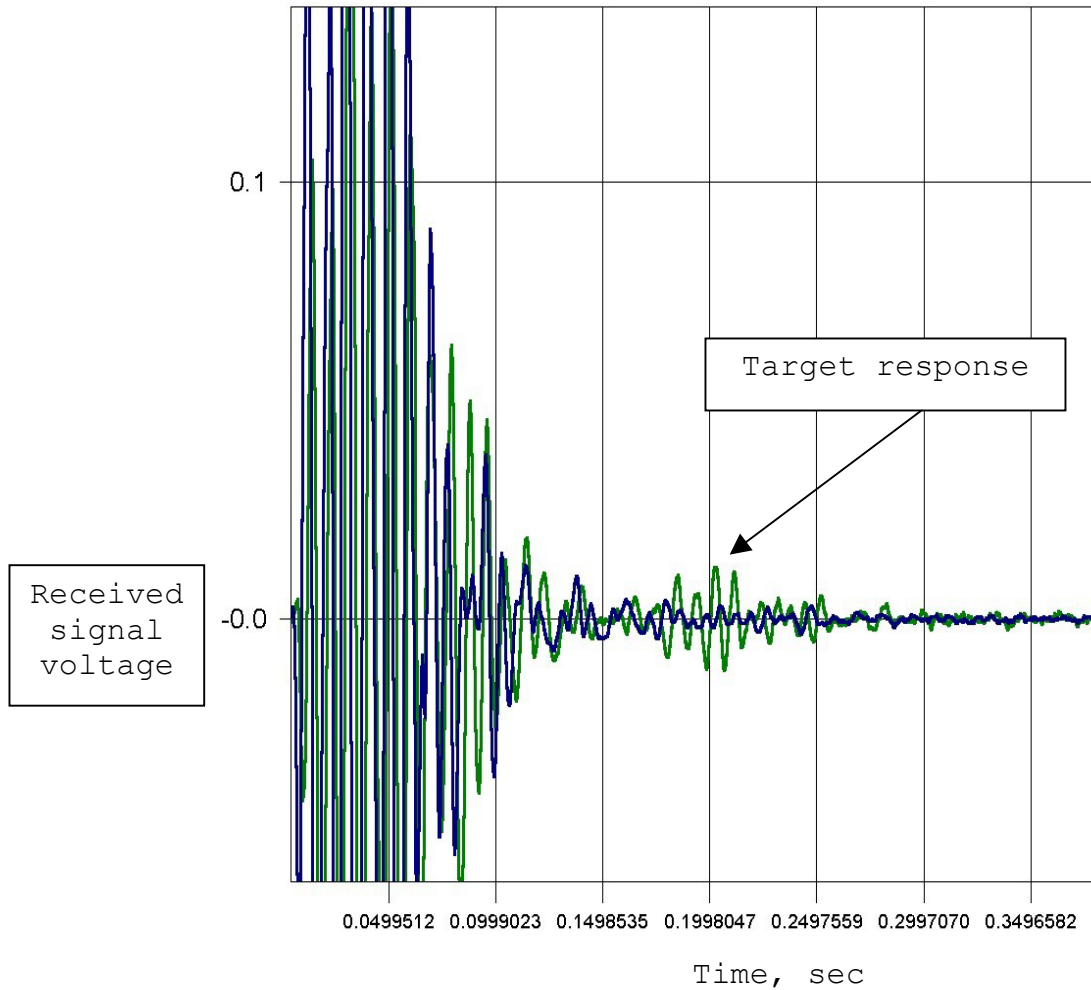

Figure 33. Radial time signal for 1,000 lb. bomb, together with a time trace with no target

These time and auto correlation traces prove that the rolling line source is a viable military option for seismic mine hunting sonar. For smaller targets, the techniques of additional amplification, averaging, coherent subtraction,



vector polarization filtering and perhaps other signal processing techniques, as well as more powerful sources, would all be useful.

## V. CONCLUSION AND RECOMMENDATIONS

The purpose of this thesis was to develop a surface source for a seismic sonar. A very crude rolling line source was successfully designed and tested. A rolling source, which can be attached to a robotic vehicle or "pushed" by a soldier, sailor or Marine or even attached to a Humvee, is the next step in the development of a mobile seismic sonar system. Previous work on the buried mine problem has developed signal processing programs and other sources. This thesis focused only on the source itself, although the correlation processing used shows promise.

The surface rolling source and seismometer array configuration are likely to be quite useful for future developments. A surface rolling source showed signal strengths comparable to previous work with buried sources. The mobility aspect of the work presented in this thesis is significant for future research and development. The series configuration for the seismometers, adding voltages, was suitable for exploration experiments, but current, rather than voltage, amplifiers would be advantageous, so parallel seismometer configurations can be used. Two such units have been procured for use on this research project at NPS.

The last iteration of the rolling line source in this thesis, the shakers that were mounted directly to the

interior of the tube wall, is ideal. The sources mounted inside the rim of the rolling stock are perfectly situated for maximum coupling of vibratory energy to the sediment or soil, as this energy does not have to pass through a lossy contraption such as an axle, that will have its own resonant frequencies, different from the ones desired for the job at hand!

Further work on the mechanics of the rolling tube, seismic source could take advantage of 1) new, well engineered, vibratory sources that have recently appeared on the market, that are ten times more powerful than those used in this thesis. Ten of these units have been ordered and delivered to NPS for use on this project, 2) re-designing the vibratory source layout within the tube(s) for "balanced" rotary motion, making them "pushable" or "towable" at high speeds of advance, 3) incorporating the multiple sources within the "balanced" tube design so that seismic sonar "pinging" can be done more frequently than once every complete circumferential rotation, thereby increasing the rate of interrogation of the sediment or soil, for the presence of buried ordnance, and finally 4) the incorporation of a "handing yoke" with ball bearings to easily enable the operators to move this device, wherever it needs to go.

The next steps in this evolutionary chain are improvements in the following areas: 1) a deployable, rolling, seismometer array needs to be developed. Some work was started on this subject, to the degree of making

small sleds and separators, but it was not fully realized. Finally, 2) miniaturize the electronic components to either put the system on a robot, or make it easier to "man handle" by sailors, Marines, and soldiers.

It should be mentioned that, some preliminary testing was performed in conjunction with a robotic course taught at the Naval Postgraduate School, which illustrated the ability for a small Lemmings robot to tow the tube over the terrain of the NPS quadrangle.

This rolling tube seismic sonar for buried mine ordinance detection, has a great future for military and naval systems. It can detect subsurface objects, on the go, at ranges measured in tens of meters, thus rendering systems such as ground penetrating radar completely obsolete. It can also be designed to work underwater, thereby covering the very shallow water encountered on the "wet end" of amphibious assault operations.

THIS PAGE INTENTIONALLY LEFT BLANK

## APPENDIX A. SM-11 GEOPHONE



- 30-Hz geophone with high spurious, over 500 Hz, providing wide bandwidth data suitable for up to 1-ms data sampling
- Can be operated in any orientation
- High output through the use of a special magnet and case design
- Rugged mechanical construction can withstand severe shocks
- 2-year limited warranty



The SM-11 geophone is suitable for use in extended frequency, high-resolution surveys. It has a natural frequency of 30 Hz and a spurious frequency of over 500 Hz, providing a sensor suitable for use with 1-ms sampling recording systems. The use of a special magnetic circuit makes the output of this geophone higher than normal 30-Hz geophones, ensuring adequate signal strength. The high natural frequency spring design also allows this geophone to be used in any orientation (vertical, horizontal, or inverted).

The SM-11 can be installed in the I/O Sensor PE-11 land case.

Typical application: high-resolution seismograph reflection studies.

## Specifications

INPUT/OUTPUT, INC.

		SM-11/U-FT
<b>Frequency</b>		
Natural frequency ( $f_n$ )		30 Hz
Tolerance		±5%
Maximum tilt angle for specified $f_n$		180°
Typical spurious frequency		>500 Hz
<b>Distortion</b>		
Distortion with 0.7 in/s p.p. coil-to-case velocity		<0.2%
Distortion measurement frequency		30 Hz
Maximum tilt angle for distortion specification		180°
<b>Damping</b>		
Open-circuit damping		0.55
Open-circuit damping tolerance		±5%
<b>Resistance</b>		
Standard coil resistances		360 Ω
Tolerance		±5%
<b>Sensitivity</b>		
Open-circuit sensitivity		30 V/m/s (0.75 V/in/s)
Tolerance		±5%
$R_e B_c f_n$		7,785 ΩHz
Moving mass		9.2 g (0.32 oz)
Maximum coil excursion p.p.		>1 mm (>0.04 in)
<b>Physical Characteristics</b>		
Diameter		26.6 mm (1.02 in)
Height		32 mm (1.26 in)
Weight		89 g (3.13 oz)
Operating temperature range		-40°C to +100°C (-40°F to +212°F)
<b>Limited Warranty Period*</b>		
		2 years
		* Warranty excludes damage caused by high-voltage and physical damage to the element case.

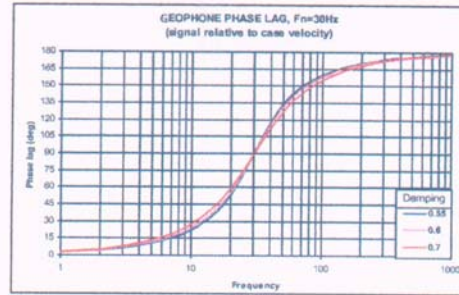
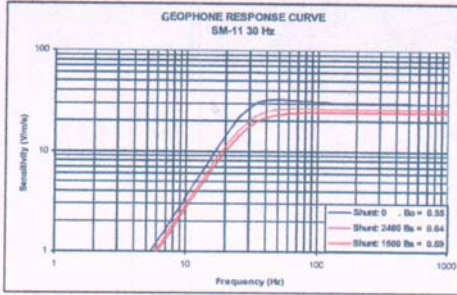

## Ordering Information

SM-11	
SM-11/U-FT 30 Hz 360 Ω (upright)	P/N 1011010
SM-11/H-FT 30 Hz 360 Ω (horizontal)	P/N 1011030

United States – Stafford, TX  
Input/Output, Inc.  
Fax 281.879.3500  
Phone 281.933.3339

Russia  
Input/Output, Inc.  
Fax 7.095.2322240  
Phone 7.095.2322254

England  
Input/Output, Inc.  
Fax 44.1603.411403  
Phone 44.1603.411400

Web Site  
www.i-o.com

## APPENDIX B. MANUFACTURER SPECIFICATION OF AURA BASS SHAKER

<i>Specifications:</i>	<i>Bass Shaker</i>	<i>Pro Bass Shaker</i>
Model Number . . . . .	AST-1B-4 . . . . .	AST-2B-4
Suggested Retail Price Per Pair . . . . .	\$199 . . . . .	\$239
Frame Size . . . . .	5.4" W x 2.2" H . . . . .	5.4" W x 2.2" H
Force, Peak . . . . .	20 Lbf (89 N) . . . . .	30 lbf (132 N)
Effective Impedance . . . . .	4 Ohms . . . . .	4 Ohms
Power, Continuous . . . . .	25 Watts RMS . . . . .	50 Watts RMS
Power, Max . . . . .	50 Watts RMS . . . . .	75 Watts RMS
Height . . . . .	2.2" . . . . .	2.2"
Diameter . . . . .	5.1" . . . . .	6.2"
Weight . . . . .	3.0 lb. . . . .	3.0 lb.
Resonance Frequency (fo) . . . . .	40 Hz . . . . .	40 Hz
Usable Frequency Range . . . . .	20-80 Hz . . . . .	20-80 Hz
UPC Code . . . . .	7-94002-30750-1 . . . . .	7-94002-30770-9
QTY./Master Carton . . . . .	8 Pairs . . . . .	8 Pairs
Wt./Master Carton . . . . .	53 Lbs. . . . .	55.24 Lbs.
Dimension of Master Carton . . . . .	13.5" L x 13.0625" W x 11.375" H . . . . .	15.75" L x 15.8125" W x 9.75" H
Master Carton/Pallet . . . . .	36 M/C (288 Pairs) . . . . .	24 M/C (192 Pairs)

***Bass Shaker Frequency Response***

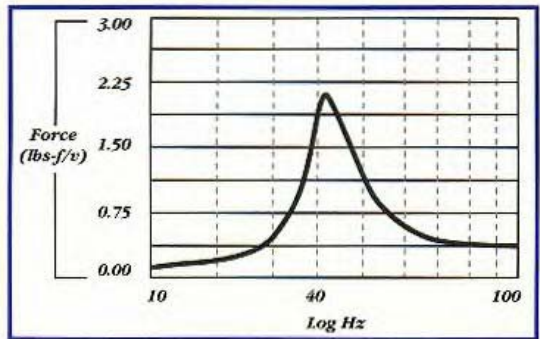

- A two-channel 50-100 Watt RMS/channel amplifier is recommended with one Bass Shaker operating from each channel.
- LPF (low pass filter), if used, should be set to 100 Hz.
- For best results, drive both Bass Shakers with same mono signal.
- Both Bass Shakers in an installation should be wired in phase. The Bass Shaker wiring is coded for phasing.
- Bass Shakers perform best when mounted rigidly to a compliant surface in the vehicle. The pan beneath the seats is usually an ideal location for mounting.
- Bass Shakers can be combined with a subwoofer.
- The 25 Watt RMS/channel Bass Shaker and 50 Watt RMS/channel Pro Bass Shaker are sold in pairs and are available with or without an optional two-channel Aura 50 Watt RMS/channel amplifier.

For additional information contact Aura Systems Interactive Division.



Phone: 310-643-5300 Fax: 310-643-9463 800-909-AURA



THIS PAGE INTENTIONALLY LEFT BLANK

**APPENDIX C. FORCE SENSOR DOCUMENTATION**



**CERTIFICATION OF CONFORMANCE**

**CUSTOMER:** NAVAL POSTGRADUATE SCHOOL  
1588 CUNNINGHAM ROAD  
MONTEREY, CA 93943-5209

**REFERENCE:** PURCHASE ORDER # N62271-98-M-0601  
PCB ORDER # 31853  
CALIBRATION SPECIFICATION ISO 10012-1 and former MIL-STD-45662A

**SUBJECT:** (1) MODEL # 260M06 FORCE SENSOR S/N 288

This is to certify that subject item(s) have been manufactured, inspected and calibrated in accordance with referenced purchase order and conforms to the applicable specification standards. The equipment used in validation is traceable to the National Institute of Standards and Technology.

PCB PIEZOTRONICS, INC.

By *M. Sotola*  
Q.C. Rep.

Approved by *R.C. Brooks*  
Q.C. Admin.

Date: October 8, 1998

Date: October 8, 1998

- ISO 9001 Certified -

PCB Piezotronics, Inc.  
3425 Walden Avenue Depew, New York 14043-2495  
Phone: 716-684-0001 FAX: 716-684-0987



### CALIBRATION CERTIFICATE

Model: 260M06  
Serial #: 288 Z - AXIS  
Description: Force Sensor  
Type: ICP

Date: 10/6/98  
By: Ron Stevens, Cal.Tech. *RS*  
Station: 0-10,000 lb. Load Cell

Sensitivity: 0.242 mV/LBF  
Linearity: 0.58% FS

Cert #: 16667

**Notes:**

- 1 Calibration is traceable to NIST and complies with ISO 10012-1 and former MIL-STD-45662A.
- 2 NIST traceability through project # 822.07/256377
- 3 This certificate may not be reproduced, except in full, without written approval.

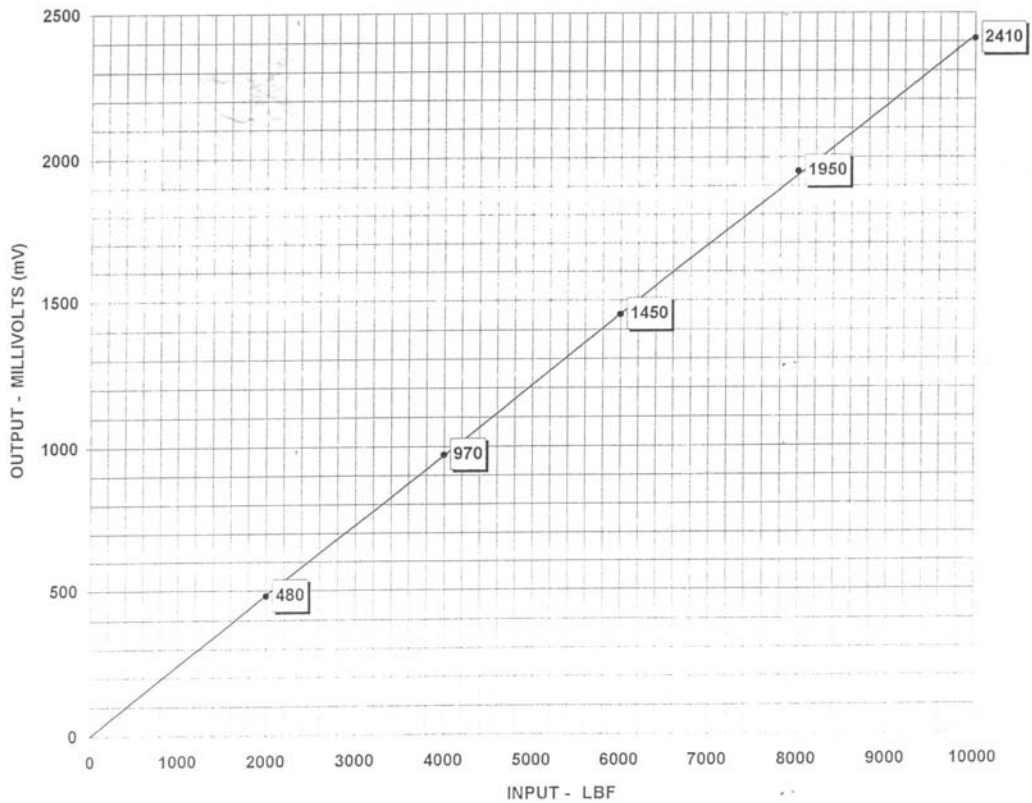

PCB PIEZOTRONICS, INC.  
3425 Walden Avenue, Depew NY 14043  
Tel: 716-684-0001 Fax: 716-684-0987  
Email: sales@pcb.com Web: www.pcb.com

ISO 9001 CERTIFIED

**DYNAMIC PERFORMANCE**

Range:	Fz	lb [kN]	10,000 [44,48]	
	Fx, Fy	lb [kN]	4,000 [17,70]	
Maximum Force:	Fz	lb [kN]	11,000 [48,93]	
	Fx, Fy	lb [kN]	4,400 [19,57]	
Broadband Resolution:	Rz	lb [N]	0.05 [0,222]	[2]
	Rx, Ry	lb [N]	0.01 [0,04]	[2]
Sensitivity (±10%):	Sz	mV/lb [mV/N]	0.25 [0,06]	[4] [5]
	Sx, Sy	mV/lb [mV/N]	1.25 [0,28]	[4] [5]
Discharge Time Constant:	DTCz	sec	≥50	
	DTCx, DTCy	sec	≥500	
Amplitude Non-Linearity		% F.S.	≤1	[1]
Stiffness:	Kz	lb/μin [N/μm]	40 [7 005]	[2]
	Kx, Ky	lb/μin [N/μm]	15 [2 495]	[2]
Cross Talk:	Fx ↔ Fy	%	±3	
	Fx, Fy ↔ Fz	%	±5	

**ENVIRONMENTAL**

Temperature Range	°F [°C]	-65 to +250 [-54 to +121]
-------------------	---------	---------------------------

**ELECTRICAL**

Full Scale Output:	Z Direction	± volts	2.5
	X and Y Direction	± volts	5
Output Impedance (All Channels)		ohms	≤100
Output Bias		+ volts	8-14
Excitation (All Channels):	Voltage	+ VDC	20-30
	Constant Current	mA	2-20
Spectral Noise:	(1 Hz) X & Y	lb/√Hz [N/√Hz]	3.0 x 10 <sup>-3</sup> [1,34 x 10 <sup>-2</sup> ]
	(10 Hz) X & Y	lb/√Hz [N/√Hz]	1.0 x 10 <sup>-3</sup> [4,45 x 10 <sup>-3</sup> ]
	(100 Hz) X & Y	lb/√Hz [N/√Hz]	4.0 x 10 <sup>-4</sup> [1,78 x 10 <sup>-3</sup> ]
	(1 kHz) X & Y	lb/√Hz [N/√Hz]	1.0 x 10 <sup>-4</sup> [4,45 x 10 <sup>-4</sup> ]
Spectral Noise:	(1 Hz) Z	lb/√Hz [N/√Hz]	2.0 x 10 <sup>-2</sup> [8,90 x 10 <sup>-2</sup> ]
	(10 Hz) Z	lb/√Hz [N/√Hz]	5.0 x 10 <sup>-3</sup> [2,22 x 10 <sup>-2</sup> ]
	(100 Hz) Z	lb/√Hz [N/√Hz]	2.0 x 10 <sup>-3</sup> [8,90 x 10 <sup>-3</sup> ]
	(1 kHz) Z	lb/√Hz [N/√Hz]	5.0 x 10 <sup>-4</sup> [2,22 x 10 <sup>-3</sup> ]
Polarity		in direction of markings	Positive

**MECHANICAL**

Dimensions	in [mm]	2.25 x 2.25 [57,1 x 57,1]
Weight (without cable)	oz [gm]	9.55 [271]
Housing	material	Stainless Steel
Connector	type	3 BNC Plugs
Mating Connector Required	type	3 BNC Jacks
Sealing	type	Hermetic
Preload	lb [kN]	≥40,000 [≥178]

**FORCE RING MOUNTING DIMENSIONS**

Bolt Diameter	in [mm]	0.765 [19,43]	
Size:	I.D. (Hole Diameter)	in [mm]	1.023 [25,98]
	Height	in [mm]	0.790 [20,07]
	Sensing Surface	in [mm]	1.800 [45,72]

**NOTES:**

- [1] Zero based best straight line.
- [2] Typical.
- [3] Preload should be at least 10 times the X and Y operating range used.
- [4] Sensitivities are for 40,000 pounds preload. Sensitivities may vary ±5% depending on preload used.
- [5] Sensitivities are dependent upon supplied bolt.
- [6] Molded integral 4 conductor cable, 212 feet [64,6 meters] long, terminating in 3 BNC plugs.

*In the interest of constant product improvement, we reserve the right to change specifications without notice.*

*ICP® is a registered trademark of PCB Piezotronics, Inc.*

**SUPPLIED ACCESSORIES:**

Model 081A71 Mounting Stud  
Model 083A11 Pilot Bushing

**OPTIONAL ACCESSORIES:**

Model 080A82 Assembly Lubricant  
Model 082B06 Anti-Friction Washer

**METRIC SUPPLIED ACCESSORIES:**

Model M081A71 Mounting Stud  
Model M083A11 Pilot Bushing



Drawn		10/19/98	Spec No.
Engineer		10/12/98	9488
Sales		10-2-98	
Approved		10-2-98	Sheet 1 of 1

APPLICATION			REVISIONS				
NEXT ASS'Y	USED ON	VAR	REV	DESCRIPTION	ECN	DATE	APP'D

9547  
 PCB Piezotronics Inc. claims proprietary rights in the information contained herein and will not be disclosed to others without written consent of PCB Piezotronics Inc.

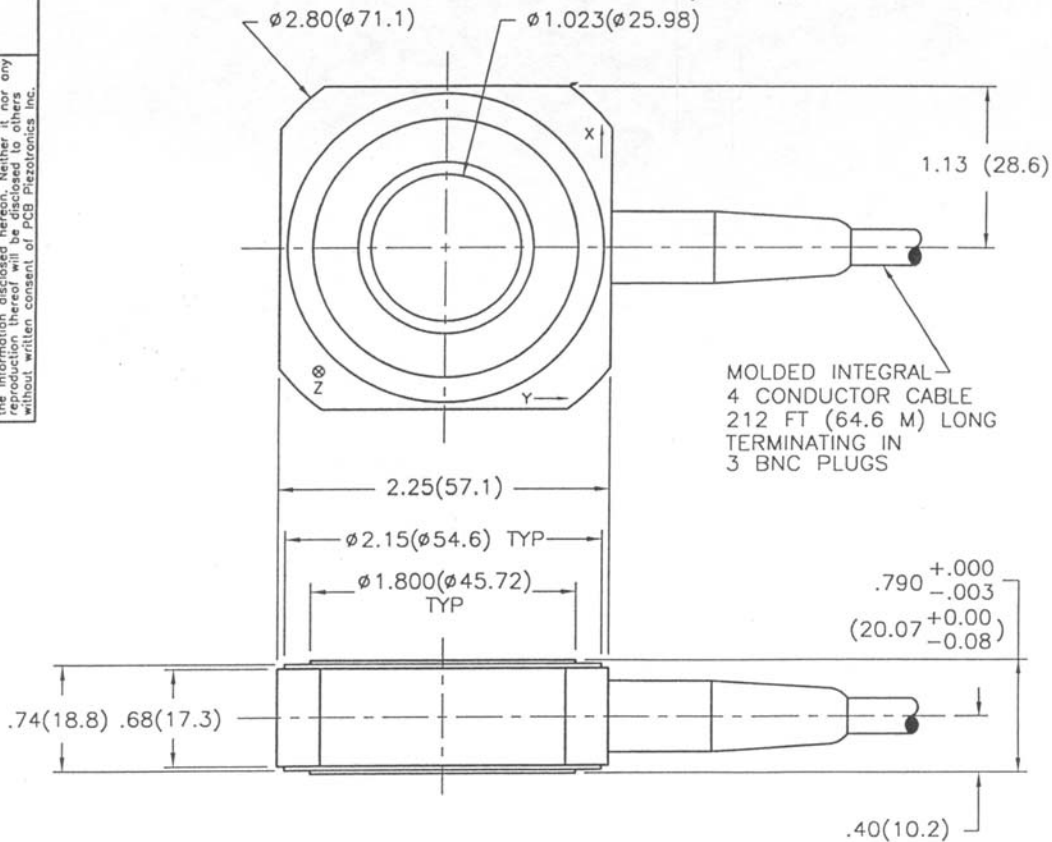

UNLESS SPECIFIED TOLERANCES		DRAWN	MFG	DATE	PCB PIEZOTRONICS
DIMENSIONS IN INCHES	DIMENSIONS IN MILLIMETERS (IN PARENTHESIS)	MDD	JBS	10/8/98	3425 WALDEN AVE. DEPEW, NY 14043 (716) 684-0001 EMAIL: SALES@PCB.COM
DECIMALS XX $\pm .01$ XXX $\pm .005$	DECIMALS XX $\pm 0.3$ XXX $\pm 0.13$	CHK'D DM	ENGR TAB	10/8/98	
ANGLES $\pm 2$ DEGREES	ANGLES $\pm 2$ DEGREES	APP'D HCT	Sales R-99	10/8/98	CODE IDENT. NO. 52681
FILLETS AND RADII .003 - .005	FILLETS AND RADII (0.07 - 0.13)	TITLE			DWG. NO. 9547
DD011 REV. B 03/13/98		OUTLINE DRAWING MODEL 260M06 ICP TRIAxIAL FORCE SENSOR			SCALE: FULL SHEET 1 OF 1

## APPENDIX D. PROFESSOR JAMES SABATIER MINE HUNTING METHOD

Professor Sabatier, of the University of Mississippi, has a method of finding buried mines, as follows: He uses a loudspeaker in air to irradiate the sediment or soil. If they are dry, there is no critical angle, and the sound directly enters the ground. This is called the "soda straw effect." Once in the ground, it penetrates straight down. If a mine is present, the top of the mine reflects the sound upwards, to the soil or sediment surface, and bounces back and forth, between the mine and the surface. He detects the vibrating surface of the soil or sediment with a scanning laser Doppler vibrometer, and plots out a pixie cell map, that shows the "hot spots," where the mines are, in an x-y format. See sketch below.

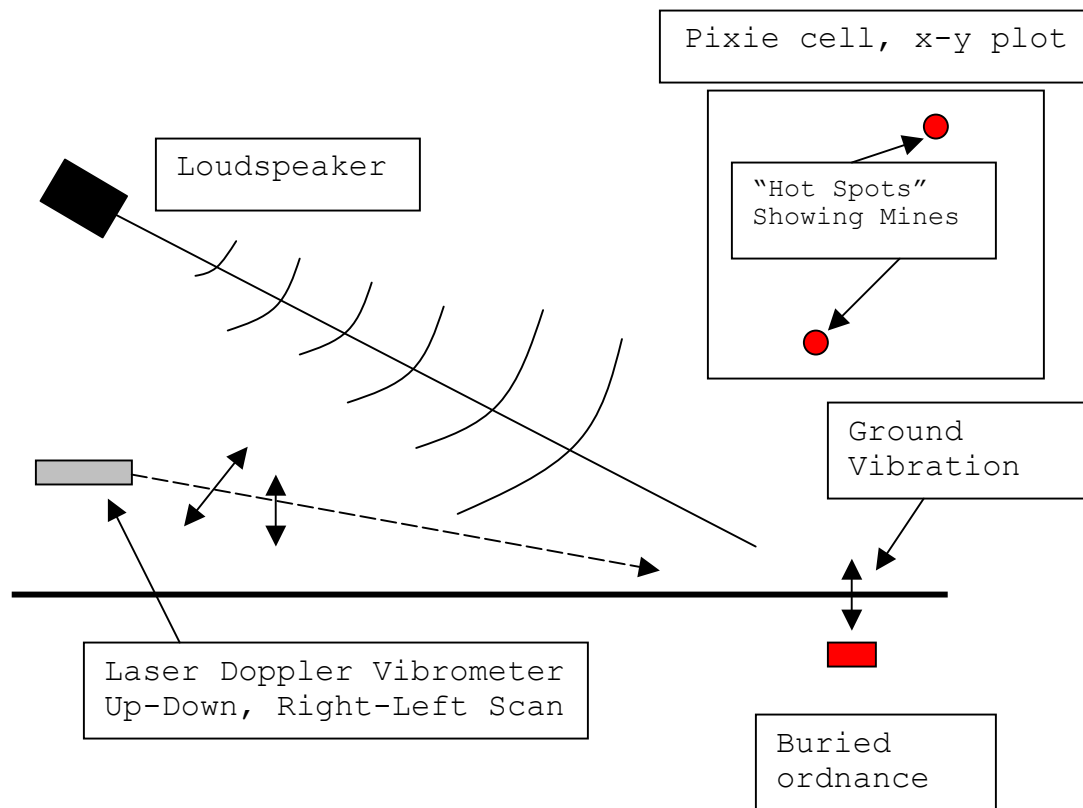

THIS PAGE INTENTIONALLY LEFT BLANK

## LIST OF REFERENCES

1. Lord Rayleigh(J.W.Strutt), On waves propagated along the planar surface of an elastic solid, Prod. Lond. Math Soc., (Ser 1) 17: 4-11, 1885
2. Telford W.M., Geldart L.P., Sheriff R.E. and Keys D.A. Applied Geophysics. Cambridge University Press, 1976.
3. Schmalfeldt, B. and Rauch, D. Ambient and Ship-Induced Low Frequency Noise in Shallow Water, in Bottom-Interacting Ocean Acoustics, William A. Kuperman and Finn B. Jensen, eds., Plenum Press, 1980
4. Brekhovskikh, L. and Goncharov, V. Mechanics of Continua and Wave Dynamics. Moscow: "Nauka" Publishing House, 1982.
5. Sabatier, J.M., Bass,H.E., Bolen, L.N., Attenborough, K., Sastry, V.V.S.S., "The Interaction of Airborne Sound with the Porous Ground. The Theoretical Formulation," Journal Acoustical Society of America, Vol. 79,pp. 1345-1352, 1986.
6. Sabatier, J.M., Bass,H.E., Bolen, L.N., Attenborough, K., Sastry, V.V.S.S., "Acoustically Deduced Seismic Waves," Journal Acoustical Society of America, Vol. 80,pp. 646-649, 1986.
7. Muir, T.G., Smith, D.E., Wilson, P.S., "Seismo-Acoustic Sonar for Buried Object Detection," Preceedings of the (Second Symposium on) Technology and the Mine Problem, Naval Postgraduate School, Monterey, CA, Nov. 1996.



8. Behrens, J., Muir, T.G., Smith, E., Wilson, P., Woltz, B., "Seismic Interface Wave Sonar," Proceedings of the Technological Meeting on Submarine Acoustics, Institute of Marine Studies of the Brazilian Navy, Ilha do Governador, Rio de Janeiro, Brazil, Sep. 1997.
9. Smith, E., Wilson, P., Bacon, F., Manning, J., Behrens, J., Muir, T. "Measurement and Localization of Interface Wave Reflections from a Buried Target", Journal Acoustical Society of America, 103(5), Pt. 1, May 1998.
10. Smith, E. "Scattering of interface waves from point like obstacles," Journal Acoustical Society of America, 103(5), Pt. 1, May 1998.
11. Gaghan, F., Baker, S., Muir, T., "Interface Wave Concepts for a Seismo-Acoustic Sonar," Joint Conference of the 16<sup>th</sup> International Congress of Acoustics and 135<sup>th</sup> Meeting of the Acoustical Society of America and published as an extended abstract in Journal Acoustical Society of America, 103(1), Jun. 1998.
12. Sheetz, K., Guy, J., Muir, T.G., Baker, S., "Seismic Sonar: The Spatial Coherence of Interference Waves in Surf Zone Sediments," Proceedings of the (Fourth Symposium on) Technology and the Mine Problem, Naval Postgraduate School, Monterey, CA, Nov. 1999.
13. Guy, J., Sheetz, K., Muir, T.G., Baker, S., "Seismic Sonar: Beamforming in the Sand," Proceedings of the (Fourth Symposium on) Technology and the Mine Problem, Naval Postgraduate School, Monterey, CA, Nov. 1999.
14. Gaghan, Jr., F.E., Discrete-Mode Source Development and Testing for New Seismo-Acoustic Sonar, Master's Thesis, Naval Postgraduate School, Monterey, CA, Mar. 1998.

15. Fitzpatrick, S.M., Source Development for a Seismo-Acoustic Sonar, Master's Thesis, Naval Postgraduate School, Monterey, CA, Dec. 1998.
16. Hall, P.W., Detection and Target-Strength Measurements of Buried Objects Using a Seismo-Acoustic Sonar, Master's Thesis, Naval Postgraduate School, Monterey, CA, Dec. 1998.
17. Sheetz, K.E. Advancements in Buried Mine Detection Using Seismic Sonar. Thesis Naval Postgraduate School, Monterey, CA, Dec. 2000.
18. Guy, J. Advancements in Buried Mine Detection Using Seismic Sonar. Thesis College of Chemistry, Physics and Electronics, College of Lyon, France, done at NPS, Dec. 2000
19. Sabatier, J.M., Xiang, N. "An Investigation of a System That Uses Acoustic-to-Seismic Coupling to Detect Buried Anti-Tank Landmines," IEEE Transactions on Geoscience and Remote Sensing, Vol. 39, pp. 1146-1154, 2001.
20. Costley, D., Sabatier, J.M., Xiang, N. "Forward-looking Acoustic Mine Detection System," Proceedings of the (Fifteenth Conference on) Detection and Remediation Technologies for Mines and Minelike Targets, ed. Dubey, A.C., Vol. IV, pp. 617-626, 2001.
21. Muir, T., Baker, S., Gaghan, Jr., F., Fitzpatrick, S., Hall, P., Sheetz, K., Guy, J., "Rayleigh Wave Sonar for Buried Object Detection," Presented at the Fifth Monterey Symposium on Technology and the Mine Problem and submitted for publication in Journal Acoustical Society of America, Naval Postgraduate School, Monterey, CA, Apr. 2002.

THIS PAGE INTENTIONALLY LEFT BLANK

## INITIAL DISTRIBUTION LIST

1. Defense Technical Information Center  
Ft. Belvoir, VA
2. Dudley Knox Library  
Naval Postgraduate School  
Monterey, CA
3. Commander PEO Mines  
2531 Jefferson Davis Hwy  
CP6 #920  
Arlington, VA
4. COMINELWARCOM  
325 5<sup>th</sup> Street SE  
Corpus Christie, TX
5. Office of the Chief of Naval Research  
800 N. Quincy St.  
Arlington VA  
Attn: Dr. Edward Estalote, Code 3210A
6. Department of Physics  
Naval Postgraduate School  
Monterey, CA
7. Professor Thomas G. Muir, Code PH/Mu  
Department of Physics  
Naval Postgraduate School  
Monterey, CA
8. Professor Steven R. Baker, Code PH/Ba  
Department of Physics  
Naval Postgraduate School  
Monterey, CA
9. MAJ Patrick W. Hall  
3211 Titanic Drive  
Stafford, VA
10. MAJ Kraig E. Sheetz  
RD#2 Box 608  
Greensburg, PA

11. LCDR Frederick E. Gaghan  
846 Central Ave.  
New Providence, NJ
12. LCDR Sean M. Fitzpatrick  
12362 Caminito Festivo  
**San Diego, CA**
13. Professor James Sabatier  
Night Vision Laboratory, US Army  
Fort Belvoir, VA
14. Anne Mayoral  
Applied Research Laboratories  
The University of Texas at Austin  
P.O. Box 8029  
Austin, TX